

Peak Emission Wavelength: 1200nm

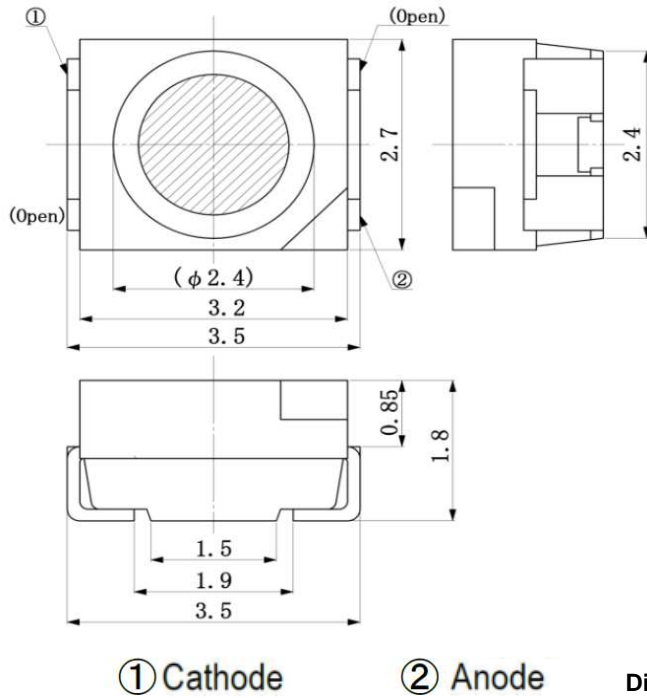

Description

- SMD 3527 (1411) Package
- Type: InGaAs/InP, MQW
- High power
- High speed
- High reliability

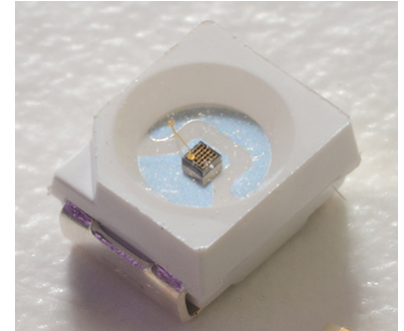

Application

- Optical switches
- Optical communication
- Safety equipment
- Automation

Absolute Maximum Ratings (Ta=25°C)



ITEMS	TEST CONDITIONS	SYMBOL	RATINGS	UNIT
Forward DC Current		If	50	mA
Forward Current (pulse)	t=10us, T = 10ms	If	500	mA
Reverse Voltage		Vr	5	V
Power Dissipation		Po	120	mW
Operating Temperature Range		Top	-20 to +80	°C
Storage Temperature Range		Tst	-30 to +100	°C
Lead Soldering Temperature	t=5sec, 3mm from case	Tslg	260	°C

Electrical & Optical Characteristics (Ta = 25°C)

ITEMS	SYMBOL	CONDITIONS	MIN	TYP	MAX	UNIT
Forward Voltage	Vf	If=20mA	--	1.0	--	V
Radiant Power	Po	If=20mA	--	4.5	--	mW
Peak Wavelength	λ_p	If=20mA	--	1200	--	nm
Spectral Bandwidth	$\Delta\lambda_{0.5}$	If=20mA	--	62	--	nm
Viewing Angle	$\Theta_{0.5}$	If=20mA	--	+/-60	--	deg

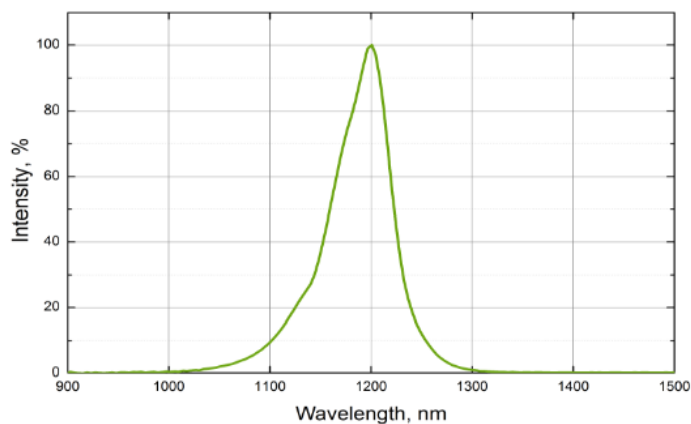

Typical spectrum @ 100 mA

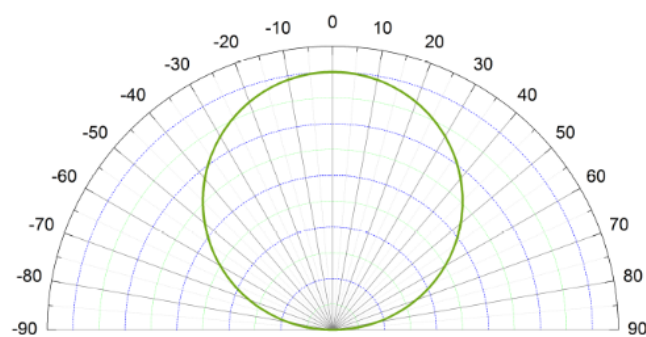

Radiation pattern

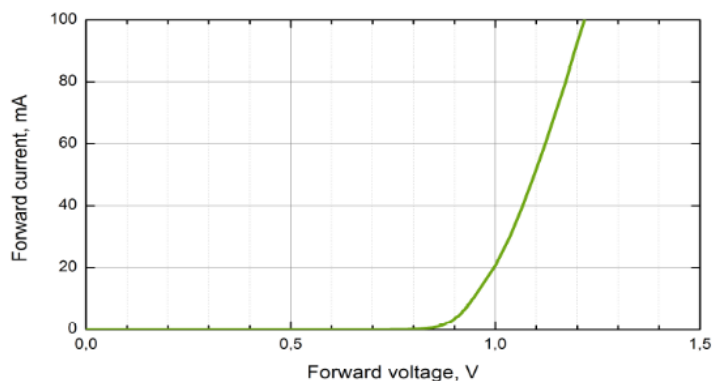

Forward current vs. forward voltage

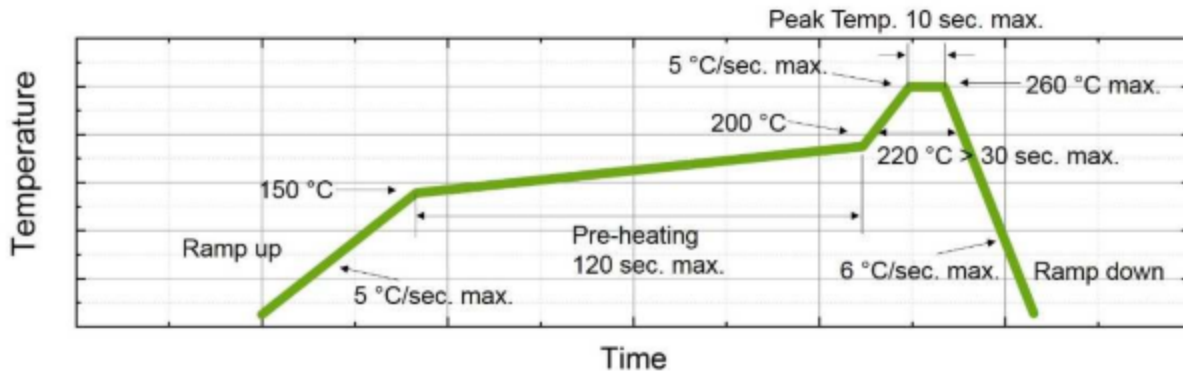

Recommended reflow soldering profile

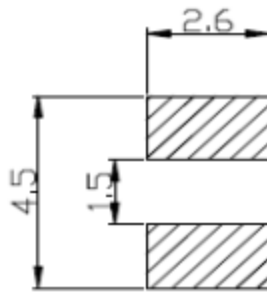

Recommended soldering pattern