

## HiPerFRED

$$V_{RRM} = 1200 \text{ V}$$

$$I_{FAV} = 2 \times 30 \text{ A}$$

$$t_{rr} = 40 \text{ ns}$$

High Performance Fast Recovery Diode  
Low Loss and Soft Recovery  
Common Cathode

Part number

**DSEC60-12A**

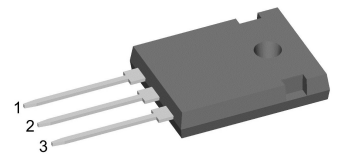

Backside: cathode

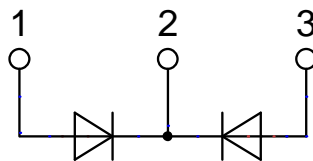

#### Features / Advantages:

- Planar passivated chips
- Very low leakage current
- Very short recovery time
- Improved thermal behaviour
- Very low  $I_{rm}$ -values
- Very soft recovery behaviour
- Avalanche voltage rated for reliable operation
- Soft reverse recovery for low EMI/RFI
- Low  $I_{rm}$  reduces:
  - Power dissipation within the diode
  - Turn-on loss in the commutating switch

#### Applications:

- Antiparallel diode for high frequency switching devices
- Antisaturation diode
- Snubber diode
- Free wheeling diode
- Rectifiers in switch mode power supplies (SMPS)
- Uninterruptible power supplies (UPS)

#### Package: TO-247

- Industry standard outline
- RoHS compliant
- Epoxy meets UL 94V-0

#### Terms Conditions of usage:

The data contained in this product data sheet is exclusively intended for technically trained staff. The user will have to evaluate the suitability of the product for the intended application and the completeness of the product data with respect to his application. The specifications of our components may not be considered as an assurance of component characteristics. The information in the valid application- and assembly notes must be considered. Should you require product information in excess of the data given in this product data sheet or which concerns the specific application of your product, please contact your local sales office.

Due to technical requirements our product may contain dangerous substances. For information on the types in question please contact your local sales office.

Should you intend to use the product in aviation, in health or life endangering or life support applications, please notify. For any such application we urgently recommend

- to perform joint risk and quality assessments;

- the conclusion of quality agreements;

- to establish joint measures of an ongoing product survey, and that we may make delivery dependent on the realization of any such measures.

Fast Diode				Ratings			
Symbol	Definition	Conditions	min.	typ.	max.	Unit	
$V_{RSM}$	max. non-repetitive reverse blocking voltage	$T_{VJ} = 25^{\circ}C$			1200	V	
$V_{RRM}$	max. repetitive reverse blocking voltage	$T_{VJ} = 25^{\circ}C$			1200	V	
$I_R$	reverse current, drain current	$V_R = 1200 V$	$T_{VJ} = 25^{\circ}C$		250	$\mu A$	
		$V_R = 1200 V$	$T_{VJ} = 150^{\circ}C$		1	mA	
$V_F$	forward voltage drop	$I_F = 30 A$	$T_{VJ} = 25^{\circ}C$		2.74	V	
		$I_F = 60 A$			3.27	V	
		$I_F = 30 A$	$T_{VJ} = 150^{\circ}C$		1.79	V	
		$I_F = 60 A$			2.30	V	
$I_{FAV}$	average forward current	$T_C = 120^{\circ}C$ rectangular $d = 0.5$	$T_{VJ} = 175^{\circ}C$		30	A	
$V_{FO}$	threshold voltage	} for power loss calculation only	$T_{VJ} = 175^{\circ}C$		1.12	V	
$r_F$	slope resistance				16	m $\Omega$	
$R_{thJC}$	thermal resistance junction to case				0.9	K/W	
$R_{thCH}$	thermal resistance case to heatsink			0.25		K/W	
$P_{tot}$	total power dissipation		$T_C = 25^{\circ}C$		165	W	
$I_{FSM}$	max. forward surge current	$t = 10 ms; (50 Hz), sine; V_R = 0 V$	$T_{VJ} = 45^{\circ}C$		200	A	
$C_J$	junction capacitance	$V_R = 600 V$ $f = 1 MHz$	$T_{VJ} = 25^{\circ}C$		12	pF	
$I_{RM}$	max. reverse recovery current	} $I_F = 30 A; V_R = 600 V$ $-di_F / dt = 200 A/\mu s$	$T_{VJ} = 25^{\circ}C$		8.5	A	
			$T_{VJ} = 100^{\circ}C$		13	A	
$t_{rr}$	reverse recovery time		$T_{VJ} = 25^{\circ}C$		60	ns	
			$T_{VJ} = 100^{\circ}C$		170	ns	

Package TO-247			Ratings			
Symbol	Definition	Conditions	min.	typ.	max.	Unit
$I_{RMS}$	RMS current	per terminal <sup>1)</sup>			70	A
$T_{VJ}$	virtual junction temperature		-55		175	°C
$T_{op}$	operation temperature		-55		150	°C
$T_{stg}$	storage temperature		-55		150	°C
<b>Weight</b>				6		g
$M_D$	mounting torque		0.8		1.2	Nm
$F_C$	mounting force with clip		20		120	N

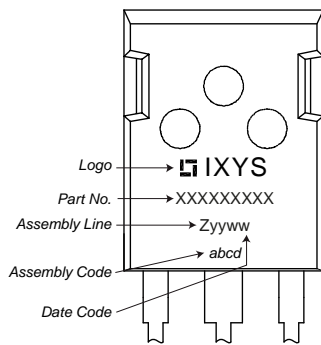
**Product Marking**

Ordering	Ordering Number	Marking on Product	Delivery Mode	Quantity	Code No.
Standard	DSEC60-12A	DSEC60-12A	Tube	30	476412

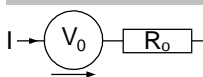
**Equivalent Circuits for Simulation**
*\* on die level*
 $T_{VJ} = 175\text{ °C}$ 

**Fast Diode**

$V_{0\ max}$	threshold voltage	1.12	V
$R_{0\ max}$	slope resistance *	13.4	mΩ

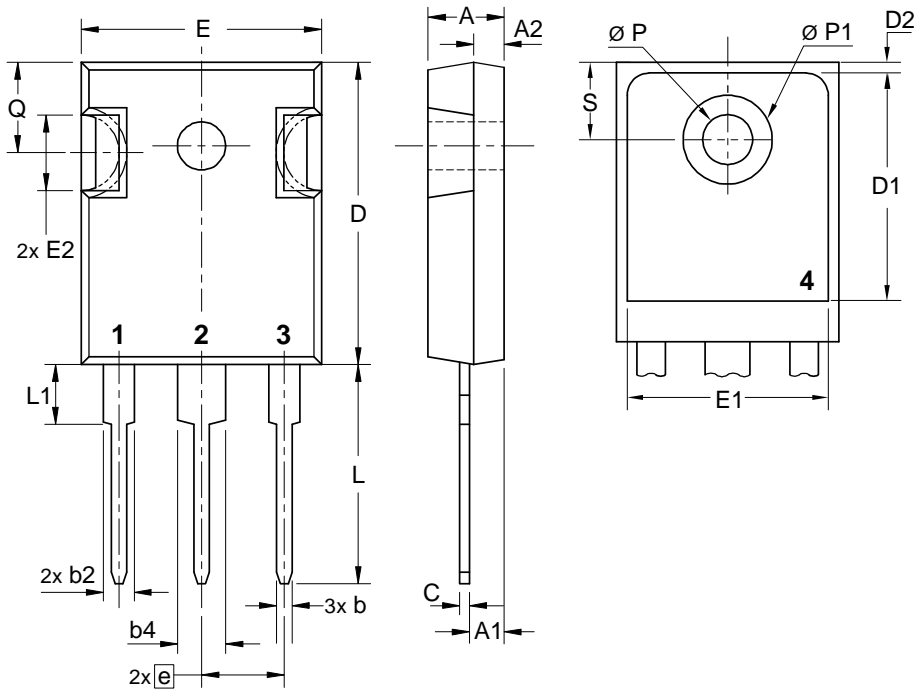
**Outlines TO-247**

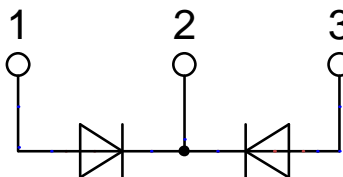

Sym.	Inches		Millimeter	
	min.	max.	min.	max.
A	0.185	0.209	4.70	5.30
A1	0.087	0.102	2.21	2.59
A2	0.059	0.098	1.50	2.49
D	0.819	0.845	20.79	21.45
E	0.610	0.640	15.48	16.24
E2	0.170	0.216	4.31	5.48
e	0.215 BSC		5.46 BSC	
L	0.780	0.800	19.80	20.30
L1	-	0.177	-	4.49
Ø P	0.140	0.144	3.55	3.65
Q	0.212 0.244		5.38 6.19	
S	0.242 BSC		6.14 BSC	
b	0.039	0.055	0.99	1.40
b2	0.065	0.094	1.65	2.39
b4	0.102	0.135	2.59	3.43
c	0.015	0.035	0.38	0.89
D1	0.515	-	13.07	-
D2	0.020	0.053	0.51	1.35
E1	0.530	-	13.45	-
Ø P1	-	0.29	-	7.39



## Fast Diode

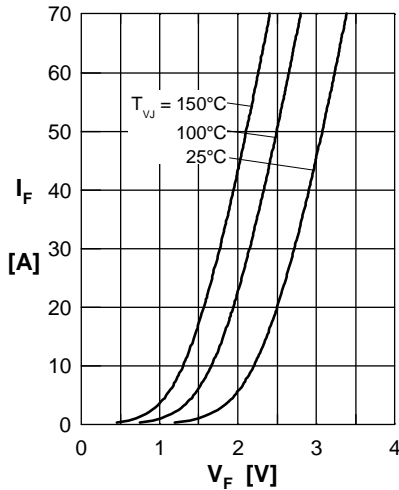

Fig. 1 Forward current  $I_F$  versus  $V_F$

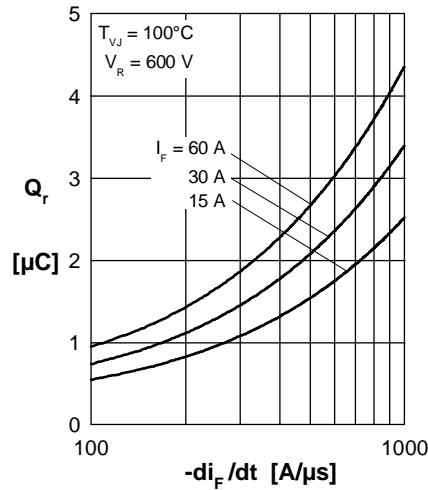

Fig. 2 Typ. reverse recov. charge  $Q_r$  versus  $-di_F/dt$

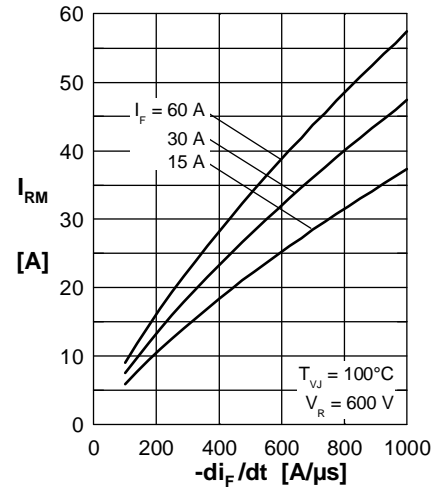

Fig. 3 Typ. peak reverse current  $I_{RM}$  versus  $-di_F/dt$

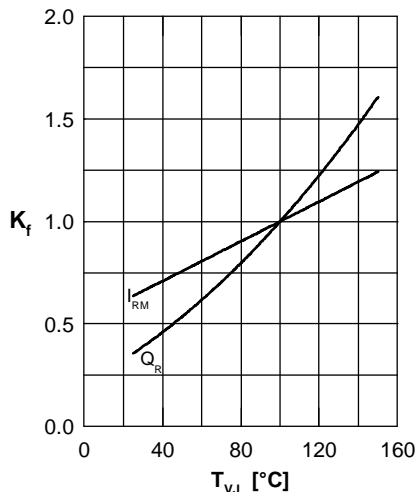

Fig. 4 Typ. dynamic parameters  $Q_r, I_{RM}$  versus  $T_{VJ}$

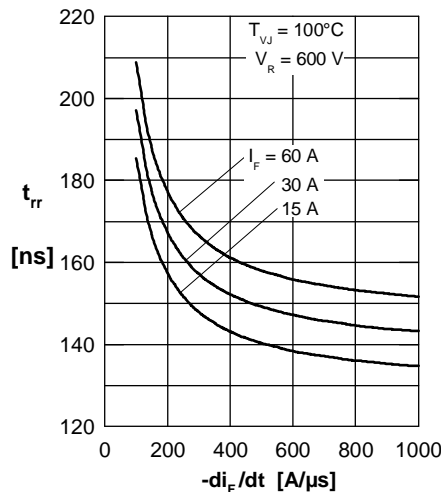

Fig. 5 Typ. recovery time  $t_{rr}$  versus  $-di_F/dt$

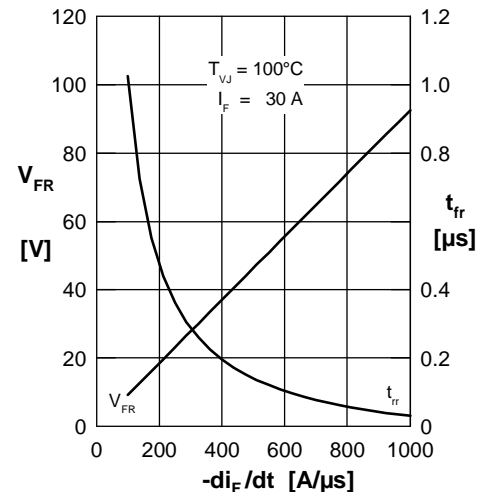

Fig. 6 Typ. peak forward voltage  $V_{FR}$  and  $t_{rr}$  versus  $di_F/dt$

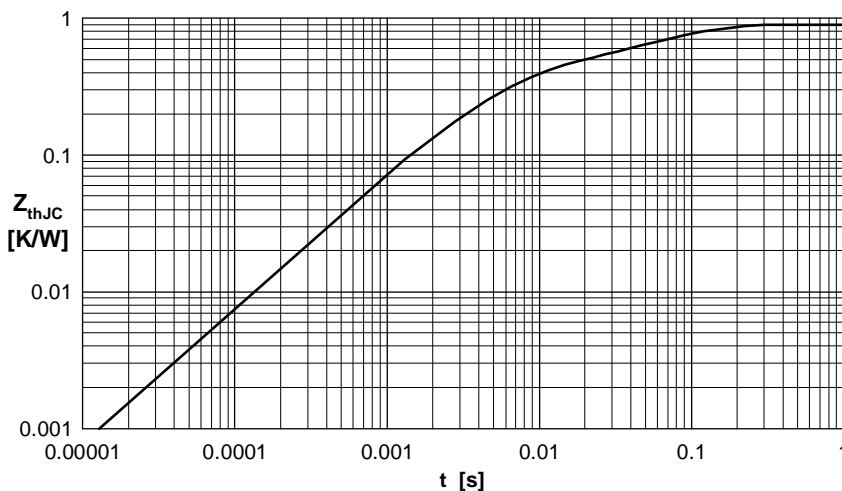

Fig. 7 Transient thermal impedance junction to case

Constants for  $Z_{thJC}$  calculation:

i	$R_{thi}$ (K/W)	$t_i$ (s)
1	0.030	0.001
2	0.080	0.030
3	0.300	0.006
4	0.490	0.060