

DISCLAIMER

© 2018 Olimex Ltd. Olimex®, logo and combinations thereof, are registered trademarks of Olimex Ltd. Other product names may be trademarks of others and the rights belong to their respective owners.

The information in this document is provided in connection with Olimex products. No license, express or implied or otherwise, to any intellectual property right is granted by this document or in connection with the sale of Olimex products.

This hardware design of STM32-P107 is neither public nor open-source. Any copying of the product would result in copyright infringement.

The software written by Olimex is released under open source terms. Every other piece of code (libraries, ready-to-use-files, etc) follow their owner's copyright.

It is possible that the pictures in this manual differ from the latest revision of the board.

The product described in this document is subject to continuous development and improvements. All particulars of the product and its use contained in this document are given by OLIMEX in good faith. However all warranties implied or expressed including but not limited to implied warranties of merchantability or fitness for purpose are excluded. This document is intended only to assist the reader in the use of the product. OLIMEX Ltd. shall not be liable for any loss or damage arising from the use of any information in this document or any error or omission in such information or any incorrect use of the product.

This evaluation board/kit is intended for use for engineering development, demonstration, or evaluation purposes only and is not considered by OLIMEX to be a finished end-product fit for general consumer use. Persons handling the product must have electronics training and observe good engineering practice standards. As such, the goods being provided are not intended to be complete in terms of required design-, marketing-, and/or manufacturing-related protective considerations, including product safety and environmental measures typically found in end products that incorporate such semiconductor components or circuit boards.

Olimex currently deals with a variety of customers for products, and therefore our arrangement with the user is not exclusive. Olimex assumes no liability for applications assistance, customer product design, software performance, or infringement of patents or services described herein.

THERE IS NO WARRANTY FOR THE DESIGN MATERIALS AND THE COMPONENTS USED TO CREATE STM32-P107. THEY ARE CONSIDERED SUITABLE ONLY FOR STM32-P107.

INTRODUCTION

STM32-P107 prototype board provides easy way for developing and prototyping with the new STM32F107VCT6 connectivity line microcontroller, produced by STMicroelectronics. STM32-P107 has JTAG port for programming and debugging, USB_OTG, user button, two status LEDs, and most of the GPIOs are on extension headers where you can connect your additional circuits.

BOARD FEATURES

- CPU: STM32F107VCT6 32 bit ARM-based microcontroller with 256 KB Flash, 64 KB RAM, USB OTG, Ethernet, 10 timers, 2 CANs, 2 ADCs, 14 communication interfaces
- JTAG connector with ARM 2×10 pin layout for programming/debugging
- Power jack for external power supply: suitable for (6.5-9)VDC or 6VAC
- USB OTG connector capable of powering the board
- USB host connector
- 100 Mbit/s Ethernet driver with RJ-45 connector
- RS232 driver with DE-09 female connector
- MiniSD card connector
- UEXT connector
- Two user-programmable buttons
- Reset button and circuit
- Two user-programmable LEDs
- Power-on LED
- 25 Mhz quartz crystal
- Extension port connectors for many of microcontrollers pins
- Prototype area
- Easy-to-change PTH jumpers
- Compatible with the bootloader tools provided by STM: "Flash Loader Demo" and "DfuSe Demo"
- PCB: FR-4, 1.5mm ~ (0.062)", soldermask, silkscreen component print
- Dimensions: (5.2×3.8)" ~ (132×97)mm

ELECTROSTATIC WARNING

The STM32-P107 board is shipped in protective anti-static packaging. The board must not be subject to high electrostatic potentials. General practice for working with static sensitive devices should be applied when working with this board.

BOARD USE REQUIREMENTS

Cables: The cable you will need depends on the programmer/debugger you use. If you use [ARM-JTAG](#), you will need LPT cable, if you use [ARM-USB-OCD](#), [ARM-USB-OCD-H](#), [ARM-USB-TINY](#), or [ARM-USB-TINY-H](#) you will need 1.8 meter USB A-B cable, for ARM-USB-OCD and ARM-USB-OCD-H you will need RS232 cable, too.

Hardware: Programmer/Debugger – one of the Olimex ARM Programmers: ARM-JTAG, ARM-JTAG-EW, ARM-USB-OCD, ARM-USB-OCD-H, ARM-USB-OCD-TINY, ARM-USB-OCD-H.

Note that Olimex OpenOCD debuggers lack SWD interface by default. There is the adapter [ARM-JTAG-SWD](#) that adds SWD to any of the programmers/debuggers mentioned above.

Additionally you can use our [ARM-JTAG-COOCOX](#) debugger which has both JTAG and SWD interfaces and works with CooCox IDE natively and with IAR EW and Keil uVision via plug-ins.

Note the board can be programmed without a debugger using the serial port (the one with the DE-9 connector).

Software: ARM C compiler

PROCESSOR FEATURES

STM32-P107 board uses the ARM-based 32-bit microcontroller STM32F107VCT6 with the following features:

- Core: ARM 32-bit Cortex™-M3 CPU
 - 72 MHz maximum frequency, 1.25 DMIPS/MHz (Dhrystone 2.1) performance at 0 wait state memory access
 - Single-cycle multiplication and hardware division
- Memories
 - 256 Kbytes of Flash memory
 - 64 Kbytes of SRAM
- Clock, reset and supply management
 - 2.0 to 3.6 V application supply and I/Os
 - POR, PDR, and programmable voltage detector (PVD)
 - 25 MHz crystal oscillator
 - Internal 8 MHz factory-trimmed RC
 - Internal 40 kHz RC with calibration
 - 32 kHz oscillator for RTC with calibration
- Low power
 - Sleep, Stop and Standby modes
 - VBAT supply for RTC and backup registers
- 2 × 12-bit, 1 μs A/D converters (16 channels)
 - Conversion range: 0 to 3.6 V
 - Sample and hold capability
 - Temperature sensor
 - up to 2 MSps in interleaved mode
- 2 × 12-bit D/A converters
- DMA: 12-channel DMA controller
 - Supported peripherals: timers, ADCs, DAC, I²Ss, SPIs, I²Cs and USARTs
- Debug mode
 - Serial wire debug (SWD) & JTAG interfaces
 - Cortex-M3 Embedded Trace Macrocell™
- 80 fast I/O ports
 - 80 I/Os, all mappable on 16 external interrupt vectors and almost all 5 V-tolerant
- 10 timers
 - four 16-bit timers, each with up to 4 IC/OC/PWM or pulse counter and quadrature (incremental) encoder input
 - 1 × 16-bit motor control PWM timer with dead-time generation and emergency stop
 - 2 × watchdog timers (Independent and Window)
 - SysTick timer: a 24-bit downcounter
 - 2 × 16-bit basic timers to drive the DAC
- 14 communication interfaces
 - 2 × I²C interfaces (SMBus/PMBus)
 - 5 USARTs (ISO 7816 interface, LIN, IrDA capability, modem control)
 - 3 SPIs (18 Mbit/s), 2 with a multiplexed I²S interface that offers audio class accuracy via advanced PLL schemes
 - 2 × CAN interfaces (2.0B Active) with 512 bytes of dedicated SRAM
 - USB 2.0 full-speed device/host/OTG controller with on-chip PHY that supports HNP/SRP/ID with 1.25 Kbytes of dedicated SRAM
 - 10/100 Ethernet MAC with dedicated DMA and SRAM (4 Kbytes): IEEE1588 hardware support, MII/RMII available on all packages

STM32F107 MEMORY MAP

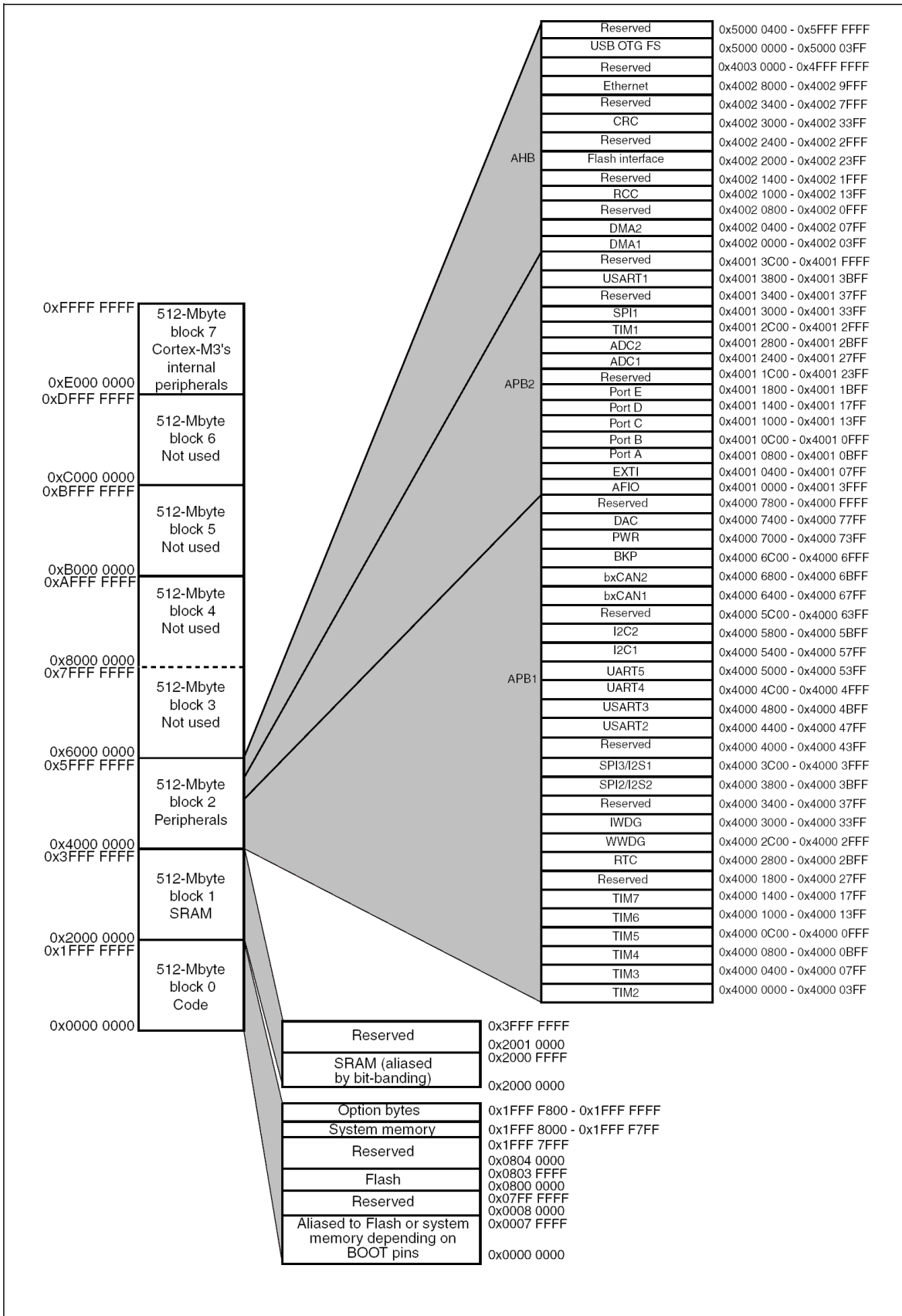

SCHEMATIC

STM32-P107, board revision C

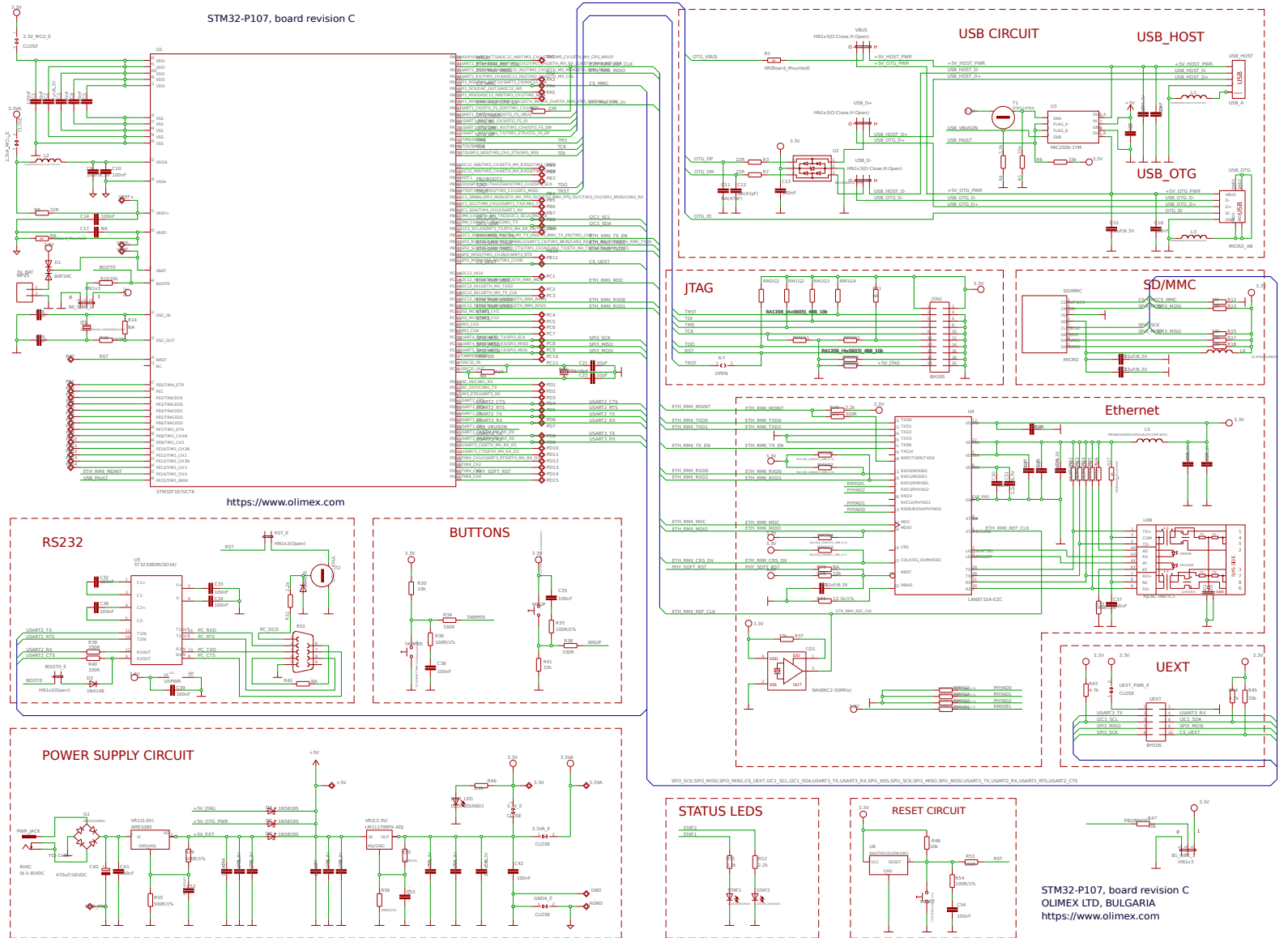

STM32-P107, board revision C
OLIMEX LTD, BULGARIA
<https://www.olimex.com>

BOARD LAYOUT

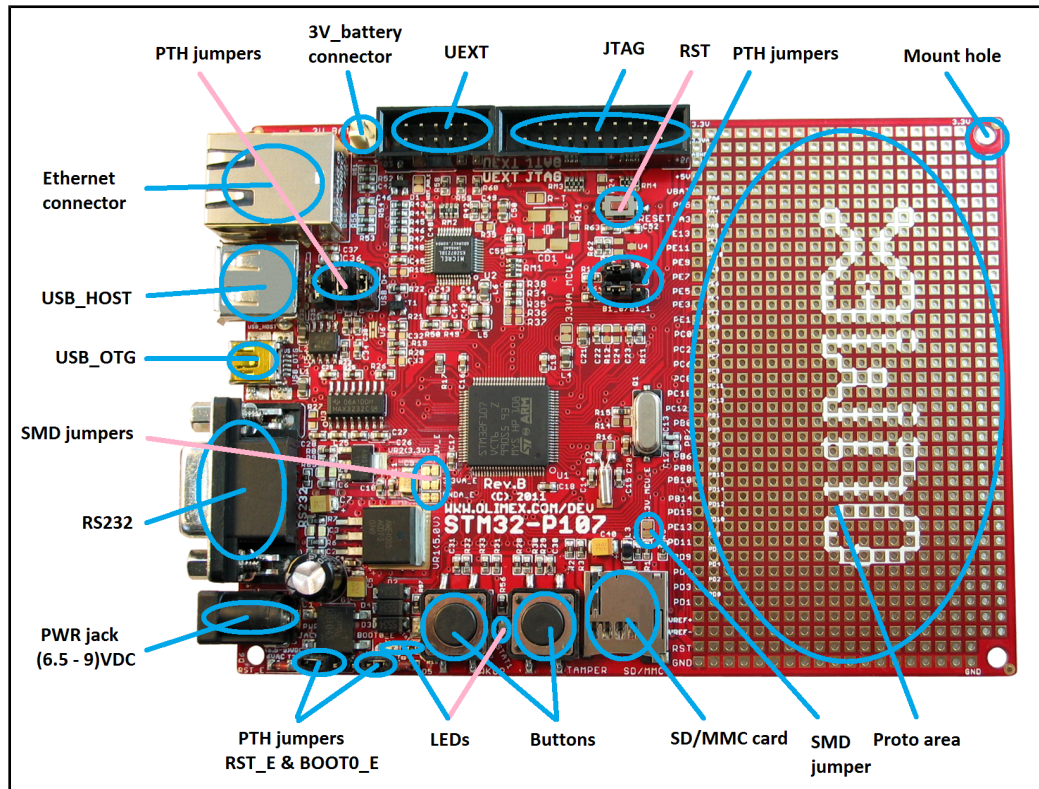

POWER SUPPLY CIRCUIT

STM32-P107 can be powered from:

- **PWR JACK** connector, where (6.5-9.0)V DC or 6.0V AC is applied from an external power source
- **USB OTG** connector; 5V voltage is provided via a mini USB cable
- **JTAG** connector; 5V voltage is provided by a compatible third party tool

The programmed board power consumption is about 70 mA.

RESET CIRCUIT

STM32-P107 reset circuit includes JTAG connector pin 15, U2 (STE101P) pin 28 (RESET), R73 (10k), R74 (330Ohm), R75 (100Ohm/1%), C55 (100nF), STM32F107 pin 14 (NRST) and RESET button.

CLOCK CIRCUIT

Quartz crystal 25 MHz is connected to **STM32F107** pin 12 (OSC_IN) and pin 13 (OSC_OUT).

Quartz crystal 32.768kHz is connected to **STM32F107** pin 8 (PC14/OSC32_IN) and pin 9 (PC15/OSC32_OUT).

JUMPER DESCRIPTION

STM32-P107 has a number of jumpers. They control the behavior of the board and allow modification of the default hardware connections. There are two types of jumpers – PTH ones (big ones, easy to change using a plastic cap) and SMT ones (pads that require cutting and soldering). It is safe to change the position of the PTH jumpers as long as you use one of the legal positions of the jumper. Changing the SMT jumpers, on the other hand, is not recommended – misconfiguration of the SMT jumpers might damage the board.

There are jumper tables printed at the back of the board!

PTH jumpers:

B0_0/B0_1 and B1_0/B1_1 control the boot mode.

B0_0/B0_1



When this jumper is in position B0_1 – BOOT0 is connected to 3.3V, and when the jumper is in position B0_0 – BOOT0 is connected to GND.

Default state is B0_0.

B1_0/B1_1



When this jumper is in position B1_1 – BOOT1 is connected to 3.3V, and when the jumper is in position B1_0 – BOOT1 is connected to GND.

Default state is B1_0.

VBUS, USB_D+, and USB_D- are responsible for the USB host control. The host can be routed to either the USB_OTG or the USB_HOST control.

VBUS



When is in position “H” - connects +5V_HOST_PWR to OTG_VBUS.

When is in position “O” - connects +5V_OTG_PWR to OTG_VBUS.

Default state is “O”.

USB_D+



When is in position “H” - connects USB_HOST_D+ to OTG_DP.

When is in position “O” - connects USB_OTG_D+ to OTG_DP.

Default state is “O”.

USB_D-



When is in position “H” - connects USD_HOST_D- to OTG_DM.

When is in position “O” - connects USB_OTG_D- to OTG_DM.

Default state is “O”.

RST_E and BOOT0_E jumpers are responsible for the system memory boot mode via UART protocol.

RST_E, BOOT0_E jumpers



Note that it is recommended to move those jumpers together – either both should be open or both should be closed.

When both are closed RS232 boot is enabled (and also B0_0/B0_1 should be in B0/1 position). You can use Flash Load Demonstrator program provided for free by STMicroelectronics: <http://www.st.com/web/en/catalog/tools/PF257525>

Default states are RST_E – open; BOOT_E – open.

SMT jumpers:

The SMT jumpers are typically used for hardware measurements and hardware debugging. Please do not attempt to change the jumpers if you lack the soldering skills required.

3.3V_MCU_E



Enable microcontroller 3.3V power supply
Default state is closed.

3.3V_E



Enable regulator VR2 (3.3V) - LM1117
Default state is closed.

3.3VA_E



Enables board 3.3V analog power supply.
Default state is closed.

3.3VA_MCU_E



Enables microcontroller 3.3V analog power supply.
Default state is closed.

GNDA_E



Enables board analog GND.
Default state is closed.

R-T



Connects RST to TRST
Default state is open.

INPUT/OUTPUT

Status LED1 (green) with name **STAT1** connected to STM32F107 pin 63 (PC6/I2S2_MCK/TIM3_CH1).

Status LED2 (yellow) with name **STAT2** connected to STM32F107 pin 64 (PC7/I2S3_MCK/TIM3_CH2).

Power-on LED (red) with name **PWR** – this led shows that +3.3V is applied to the board.

User button with name **WKUP** connected to STM32F107 pin 23 (PA0/WKUP).

User button with name **TAMPER** connected to STM32F107 pin 7 (PC13/TAMPER-RTC).

Reset button with name **RESET** connected to STM32F107 pin 14 (NRST).

CONNECTOR DESCRIPTIONS

JTAG

The JTAG connector is used to program and debug the board via a third-party tool. It can be used for JTAG and SWD programming and debugging. It is recommended to use with tools that have a compatible 20-pin 0.1 step connector.

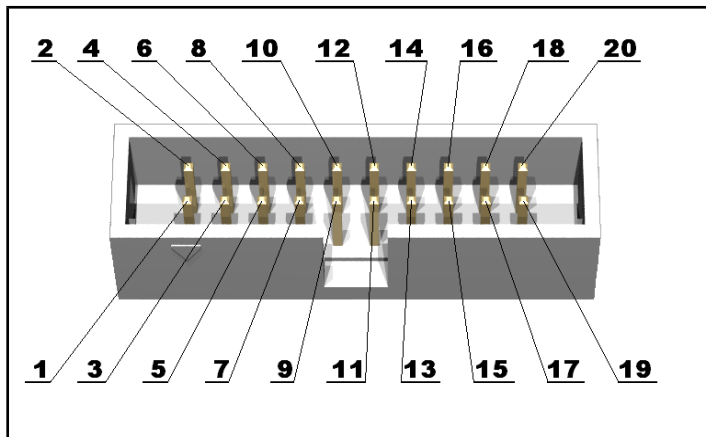

The JTAG connector allows the software debugger to talk via a JTAG (Joint Test Action Group) port directly to the core. Instructions may be inserted and executed by the core thus allowing STM32F107 memory to be programmed with code and executed step by step by the host software.

For more details please refer to IEEE Standard 1149.1 – 1990 Standard Test Access Port and Boundary Scan Architecture and STM32F107's datasheet and user's manual.

Pin #	Signal name	Pin #	Signal name
1	3.3V	2	3.3V
3	TRST	4	GND
5	TDI	6	GND
7	TMS	8	GND
9	TCK	10	GND
11	PULL-DOWN	12	GND
13	TDO	14	GND
15	RST	16	GND
17	PULL-DOWN	18	GND
19	+5V_JTAG	20	GND

PWR_JACK

The board has a standard Olimex DC barrel jack with 2.0mm inner pin and 6.3mm hole. More information about the exact component might be found here: <https://www.olimex.com/wiki/PWRJACK>

You can supply either DC or AC voltage to power the board however be careful – if you provide more than the maximum voltage suggested, you would permanently damage the board.

The suggested voltage ranges for powering the board from the PWR_JACK are:

If you are powering the board from a DC power source – you need to provide between 6.5V and 9.0V of voltage.

If you are powering the board from an AC power source – you need to provide 6.0V of voltage.

Pin #	Signal name
1	Power input
2	GND

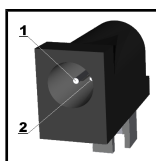

USB_HOST

If you intend to use the USB_HOST connector pay attention to the position of VBUS, USB_D+, and USB_D- jumpers. There is multiplexing between the USB_HOST connector and USB_OTG connector.

Pin #	Signal name
1	+5V_HOST_PWR
2	USB_HOST_D-
3	USB_HOST_D+
4	GND

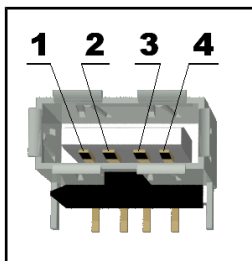

USB_OTG

If you intend to use the USB_OTG connector in host mode pay attention to the position of VBUS, USB_D+, and USB_D- jumpers. There is multiplexing between the USB_OTG connector and USB_HOST connector.

Pin #	Signal name
1	+5V_OTG_PWR
2	USB_OTG_D-
3	USB_OTG_D+
4	OTG_ID
5	GND

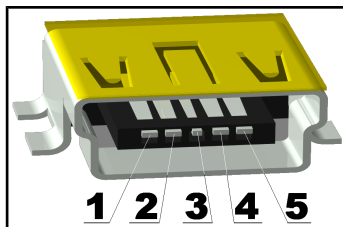

The port can be used for DFU USB mode of the STM32F107 processor. To be able to upload data you would need a mini USB cable connected to a personal computer that runs the proper software supplied by ST.

To enter the DFU mode you would also need to set the STM32-P107's jumpers properly. Make sure all jumpers are set as per default and then change the jumper B0_0/B0_1 to position B0_1 – which means boot from system memory.

More information about the DFU USB mode might be found at the ST's web-site. By the time of writing this document more information and required files can be found at this link:

<http://www.st.com/web/en/catalog/tools/PF257916>

You can download the archive that contains the graphical user interface for DFU connection. It is called “DfuSe Demo”. Extract it and install the software. Set the jumpers of STM32-P107 to boot from system memory. Leave the rest of the jumpers as per default. Connect the STM32-P107 board to the computer using a mini USB cable. This would show an unrecognized device in “Windows Device Manager”. Point the driver updater to the folder where “DfuSe Demo” was installed. After the driver installation the board would be recognized as “STM Device in DFU Mode”. At this point launch “DfuSe Demo” and restart the board. A properly connected board looks like in the picture below:

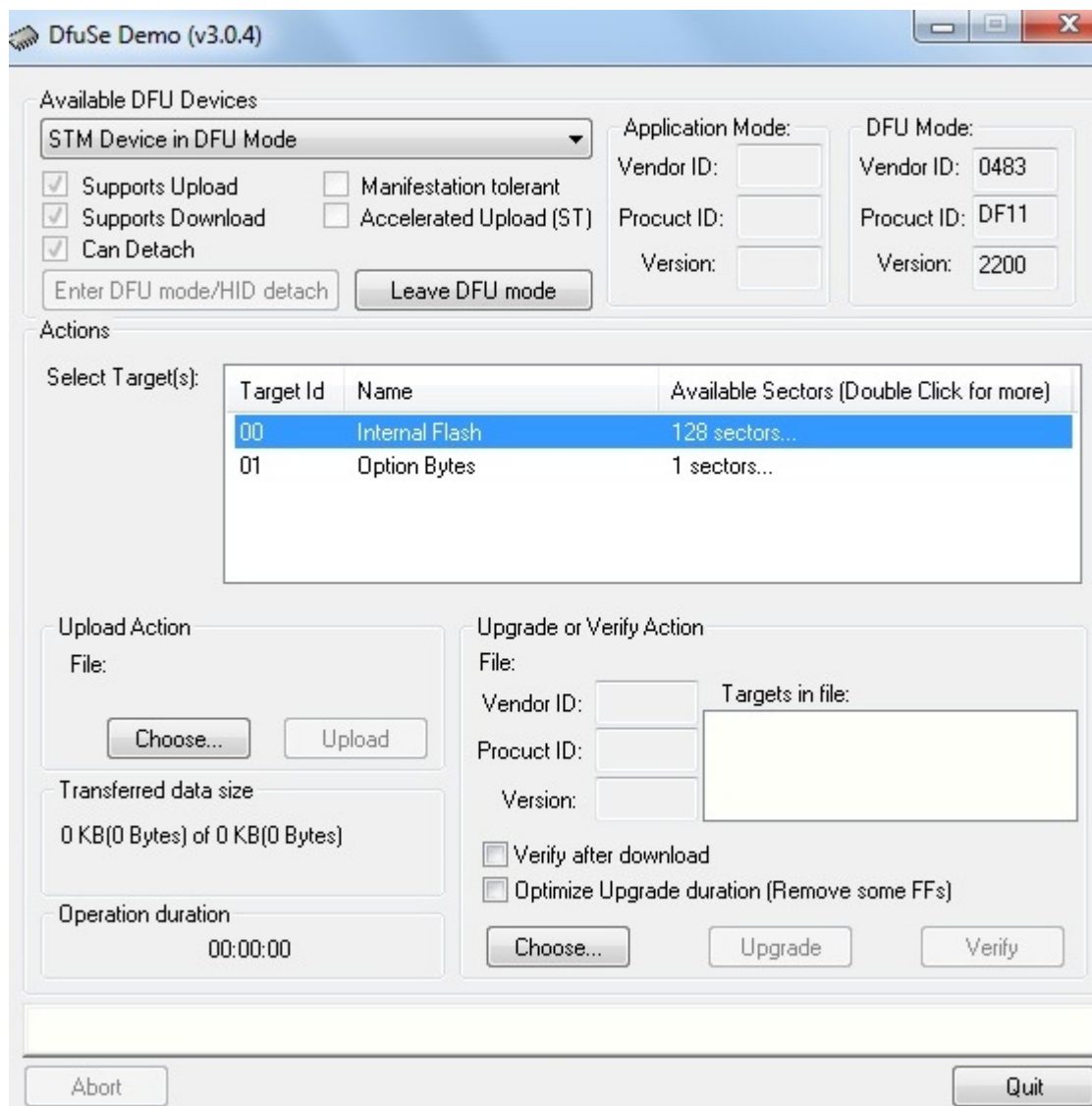

For more information about DFU mode refer to the official USB and ST web-sites.

RS232

The board can be programmed via the RS232 connector (serial interface). This is done without the need of an additional programming tool. However, you would need a proper serial cable or adapter to access it. You would also need to change the positions of three PTH jumpers (the rest of the jumpers should be as per default):

1. B0_0/B0_1 should be set to position B0_1 – which means boot from system memory
2. RST_E should be closed
3. BOOT_E should be closed

Do not confuse B0_0/B0_1 with B1_0/B1_1.

After you set the jumpers and establish the hardware connection you need to download the software provided by STMicroelectronics. It is called “Flash Loader Demonstrator”. It might be found here: <http://www.st.com/web/en/catalog/tools/PF257525> – after you install the software and establish connection you can upload hex files to the board without the need of an expensive debugger. A properly recognized board in “Flash Loader Demonstrator” is shown below:

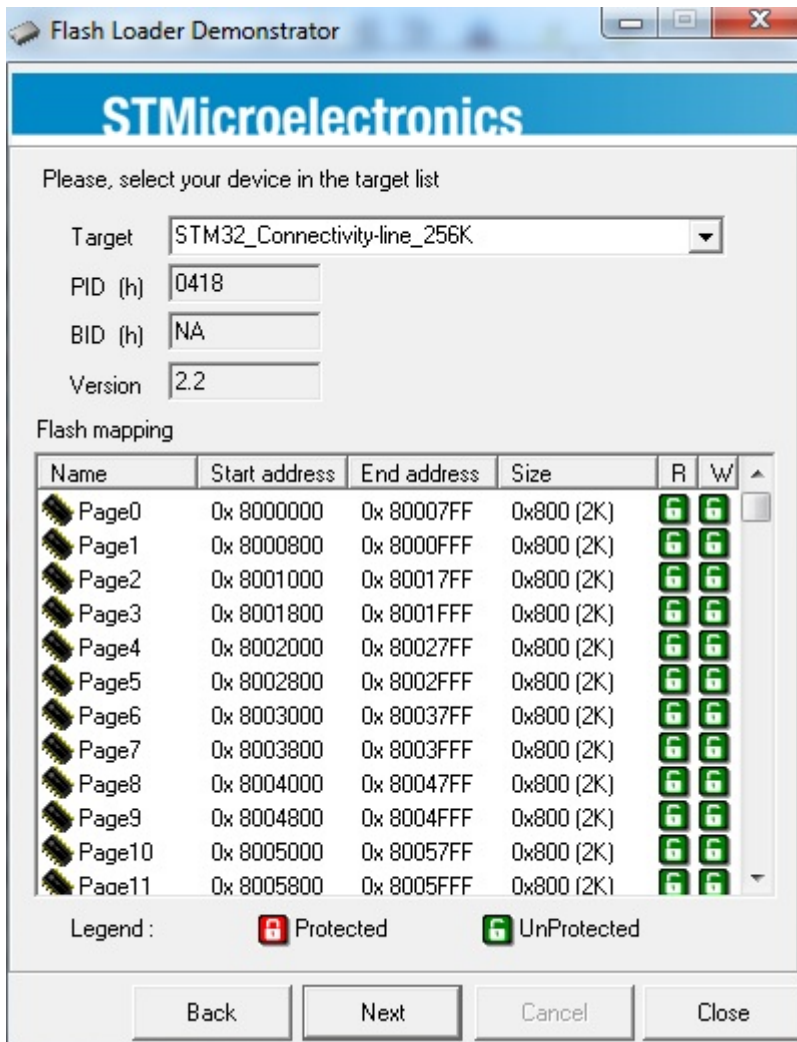

Note that this method of programming is much slower than working with a debugger. Not only the upload speed is low – you would need to perform hardware debugging routines to be able to track what is going on.

The layout of the port is shown on the next page:

Pin #	Signal name
1	NC
2	T1OUT
3	R1IN
4	NC
5	GND
6	NC
7	CTS
8	RTS
9	NC

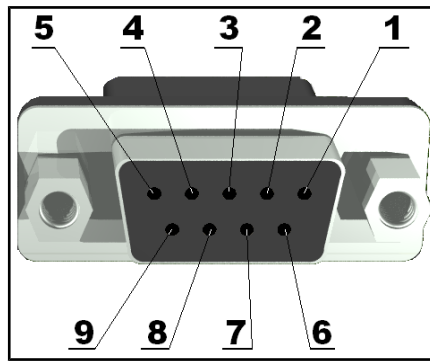

UEXT

The UEXT connector is typically used to attach additional modules to the board. It nests three popular interfaces – UART, I2C, and SPI. You can also find 3.3V power output and GND (respectively, pin #1 and pin #2).

Pin #	Signal name
1	3.3V
2	GND
3	USART2_TX
4	USART2_RX
5	I2C1_SCL
6	I2C1_SDA
7	SPI3_MISO
8	SPI3_MOSI
9	SPI3_SCK
10	CS_UEXT

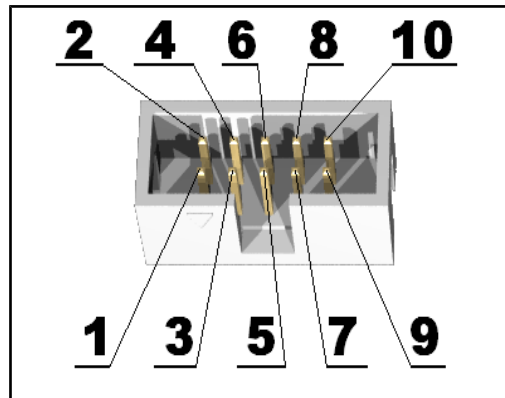

SD/MMC

Pin #	Signal name
1	MCIDAT2
2	CS_MMC
3	SPI3_MOSI
4	3.3V
5	SPI3_SCK
6	GND
7	SPI3_MISO
8	MCIDAT1
9	Not connected
10	Not connected
11	Not connected
12	Not connected

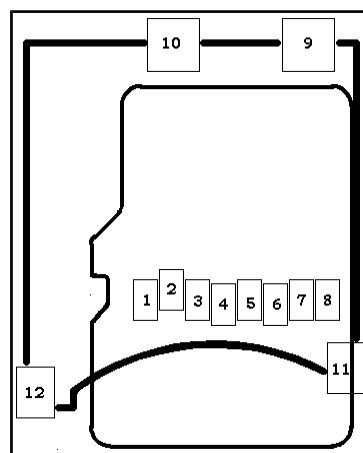

LAN

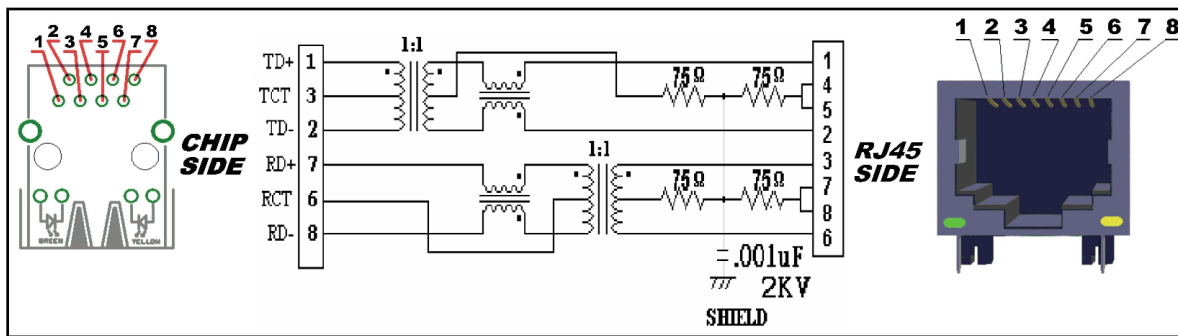

Pin #	Signal name chip side	Pin #	Signal name chip side
1	TX+	5	Not connected (NC)
2	TX-	6	VDD
3	VDD	7	RX+
4	Not connected (NC)	8	RX-

LED	Color	Usage
Right	Green	Link status
Left	Yellow	Activity status

3V_BAT

Pin #	Signal name
1	VBAT
2	GND

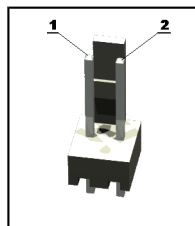

MECHANICAL DIMENSIONS

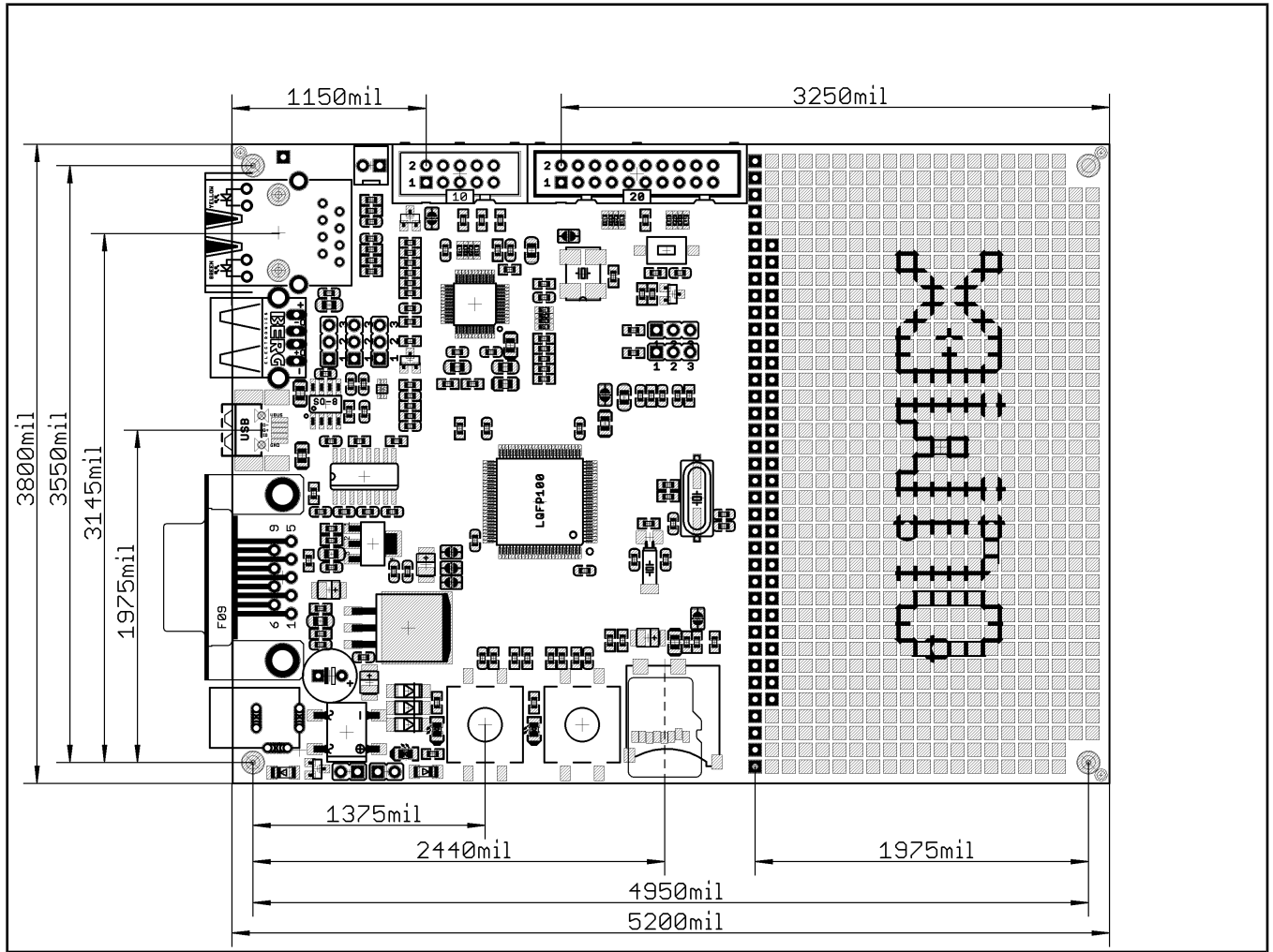

All measures are in mils.

Proto area pad pinout table:

WHITE PRINT ROW #1	PORT PROCESSOR	WHITE PRINT ROW #2	PORT PROCESSOR
3.3V	-	3.3V	-
3.3VA	-	-	-
AGND	-	-	-
+5V	-	-	-
VBAT	-	-	-
PA4	PA5	PA5	PA6
PA2	PA3	PA3	PA4
PE14	PE13	PA1	PA0
PE12	PE11	PE13	PE12
PE10	PE9	PE11	PE10
PE8	PE7	PE9	PE8
PE6	PE5	PE7	PE6
PE4	PE3	PE5	PE4
PE2	PE1	PE3	PE2
PC1	PC0	PE1	PE0
PC2	PC2	PC3	PC3
PC4	PC6	PC5	PC7
PC6	PC8	PC7	PC9
PC8	PC11	PC9	PC12
PC10	PC13	PC11	PC14
PB1	PB0	PB2	PB1
PB3	PB2	PB4	PB5
PB5	PB6	PB6	PB7
PB7	PB8	PB8	PB9
PB9	PB10	PB11	PB15
PB10	PB14	PD14	PD14
PD15	PD15	PD12	PD12
PD13	PD13	PD10	PD10
PD11	PD11	PD8	PD8
PD9	PD9	PD7	PD6
PD6	PD6	PD5	PD4
PD4	PD4	PD3	PD2
PD2	PD1	PD10	PD10
VREF+	-	-	-

AVAILABLE DEMO SOFTWARE

All demo examples are available at the board's web-page (<https://www.olimex.com/Products/ARM/ST/STM32-P107/>) and wiki article (<https://www.olimex.com/wiki/STM32-P107>). Make sure that the demo you download is compatible with the board revision you have! The board revision is printed on STM32-P107 itself.

REVISIONS AND ORDERING INFORMATION

STM32-P107 – fully assembled and tested

You can purchase directly from our online shop or from any of our distributors. Note that usually it is faster and cheaper to purchase Olimex products from our distributors. List of confirmed Olimex LTD distributors and resellers: <https://www.olimex.com/Distributors>.

Please visit <https://www.olimex.com/> for more info.

User's manual revision history:

REV. I	- created December 2009
REV. A	- edited by TU December 2010
REV. B	- demo software added and mechanical dimensions detail
REV. C	- rev. A schematic and added more programmers in BOARD USE REQUIREMENTS.
REV. D	- edited June 2011 – changed schematic
REV. E	- changed schematics to rev. B, added board revision history
REV. F	- added BOOT0_E, RST_E description, changed dimensions, updated revision B pictures, updated disclaimer
REV.G	- updated the information to fit board revision C, updated schematics, improved document layout, added product support information, updated links
REV.H	- improved information about bootloader
REV.I	- changed the schematic on page 8
REV.J	- added picture of the protoarea pads with their respective labels
REV.K	- added new information about DFU mode, hardware revision D changelog
REV.L	- February 2018 - added table that details the protoarea pinout

Board revision history:

rev. A

=====

1. ST2052BD is exchanged with LM3526-L.
2. SD/MMC signals are changed as follows:
SPI1_MOSI -> SPI3_MOSI
SPI1_SCK -> SPI3_SCK
SPI1_MISO -> SPI3_MISO
and SPI1_NSS renamed to CS_MMC
3. Changed the polarity to + of C36

rev. B

=====

1. Ethernet PHY is changed from STE101P to MICREL's one – KS8721BLMM
2. All 10uF/6.3V/TANT are changed to 0805 and a lot of element names are changed.
3. PWR_SEL jumpers are replaced by diodes.
4. USART3 is connected to UEXT while USART2 is connected to RS232 and bootloader functionality is enabled! Two additional jumpers are added!!!
5. Added UEXT_PWR_E jumper!

6. A lot of jumpers are added into the jumpers description table

rev. C

=====

1. L2 is now placed further from USB_HOST connector to avoid contact
2. Ethernet PHY Micrel KS8721 is changed to LAN8710A-EZC in RMII
3. Changed C18 from 100n to 4.7uF/6.3V according to the datasheet. C18 is now renamed C3.
4. STAT1, STAT2 and PWR_LED were changed to 0603 and its resistors to 2.2k.
5. SD/MMC capacitor was replaced by 2×22uF/6.3V capacitors.
6. LM3526 was exchanged with MIC2026-1YM and connection between pin 1 and pin4 was swapped because the default EN level is opposite.
7. All tantalum capacitors are changed to ceramic.
8. Optimizations in the values of few other elements as well.
9. R28(0R) was changed to 10k, C55=10uF/6.3V was added and RST connection was removed from the PHY!

rev. D

=====

1. All libraries were updated.
2. SD/MMC package was changed to TFC-WPAPR-08.
3. CD1 package was changed from 7×5mm to 5032.
4. 1nF/2kV/X7R/1206 capacitor was added to the LAN's connector and the routing was changed a little.
5. L1,L2,L3 and L5 values were changed from FB0805/600R/200mA(201209-601) to FB0805/600R/2A.
6. L4 was changed from CL470nH/0805/1.76R/250mA to FB0805/600R/2A.
7. C7 and C9 were changed from 0805 to 0603.
8. C53's package was changed from 0805 to 0603.

WARRANTY AND SUPPORT

For product support, hardware information and error reports mail to: support@olimex.com. All document or hardware feedback is welcome. Note that we are primarily a hardware company and our software support is limited. Please consider reading the paragraph below about the warranty of Olimex products.

All goods are checked before they are sent out. In the unlikely event that goods are faulty, they must be returned, to OLIMEX at the address listed on your order invoice.

OLIMEX will not accept goods that have clearly been used more than the amount needed to evaluate their functionality.

If the goods are found to be in working condition, and the lack of functionality is a result of lack of knowledge on the customers part, no refund will be made, but the goods will be returned to the user at their expense.

All returns must be authorized by an RMA Number. Email support@olimex.com for authorization number before shipping back any merchandise. Please include your name, phone number and order number in your email request.

Returns for any unaffected development board, programmer, tools, and cables permitted within 7 days from the date of receipt of merchandise. After such time, all sales are considered final.

Returns of incorrect ordered items are allowed subject to a 10% restocking fee. What is unaffected? If you hooked it to power, you affected it. To be clear, this includes items that have been soldered to, or have had their firmware changed. Because of the nature of the products we deal with (prototyping electronic tools) we cannot allow returns of items that have been programmed, powered up, or otherwise changed post shipment from our warehouse.

All returned merchandise must be in its original mint and clean condition. Returns on damaged, scratched, programmed, burnt, or otherwise 'played with' merchandise will not be accepted.

All returns must include all the factory accessories which come with the item. This includes any In-Circuit-Serial-Programming cables, anti-static packing, boxes, etc.

With your return, enclose your PO#. Also include a brief letter of explanation of why the merchandise is being returned and state your request for either a refund or an exchange. Include the authorization number on this letter, and on the outside of the shipping box.

Please note: It is your responsibility to ensure that returned goods reach us. Please use a reliable form of shipping. If we do not receive your package we will not be held liable.

Shipping and handling charges are not refundable. We are not responsible for any shipping charges of merchandise being returned to us or returning working items to you.

The full text might be found at <https://www.olimex.com/wiki/GTC#Warranty> for future reference.