

DETAILS

Product Number	F14486_FLORENCE-Z30
Family	Florence
Type	Lens array
Color	clear
Diameter	286 x 61 mm
Height	8,5 mm
Style	rectang
Optic Material	PMMA
Holder Material	
Fastening	
Status	production ready
ROHS Compliant	Yes
Date Updated	5/04/2017



OPTICAL PROPERTIES

LED	Viewing	Light	Effi-	cd/lm	Connector
	Angle	Beam	ciency		
TRIDINO R3 8x0 1100 1ft HV	28 deg	Medium	91 %	2.500	-
LG 5630	29 deg	Medium	94 %	2.200	-
LUXEON 3030 2D	26 deg	Medium	87 %	2.600	-
LUXEON XR-3535L (L202 - xxxx033C3007)	27 deg	Medium	93 %	2.400	-
LUXEON 3535L HE	29 deg	Medium	93 %	2.370	-
MP-2016	24 deg	Medium	92 %	3.000	-
NF2x757G	sim: 25	Medium	sim: 90 %	sim: 3.200	-
PLG2-BAR-1100-xxx-280x55-DC	29 deg	Medium	91 %	2.310	-
Duris S2	23 deg	Medium	90 %	2.820	-
Duris E5	28 deg	Medium	91 %	2.400	-
Duris E 2835	sim: 29	Medium	sim: 94 %	sim: 2.800	-
Fortimo LED Line 1ft 650lm 8x0 3R xV2/28	28 deg	Medium	94 %	2.200	-
Fortimo LED Line 1ft 1100lm xx0 3R xV2/27	27 deg	Medium	90 %	1.770	-
Fortimo LED Line 1ft 2000lm 8xx 3R HV232	232 deg	Medium	92 %	1.800	-
LT-R286A	29 deg	Medium	94 %	2.300	-
LM561B	28 deg	Medium	93 %	2.440	-
LM561C	28 deg	Medium	93 %	2.420	-
LM561B Plus	27 deg	Medium	93 %	2.570	-
SEOUL 5630C	sim: 28	Medium	sim: 90 %	sim: 2.970	-
SEOUL 5630D	sim: 29	Medium	sim: 90 %	sim: 3.100	-
STARK LLE-55-280-1650 CLASSIC	29 deg	Medium	93 %	2.200	-

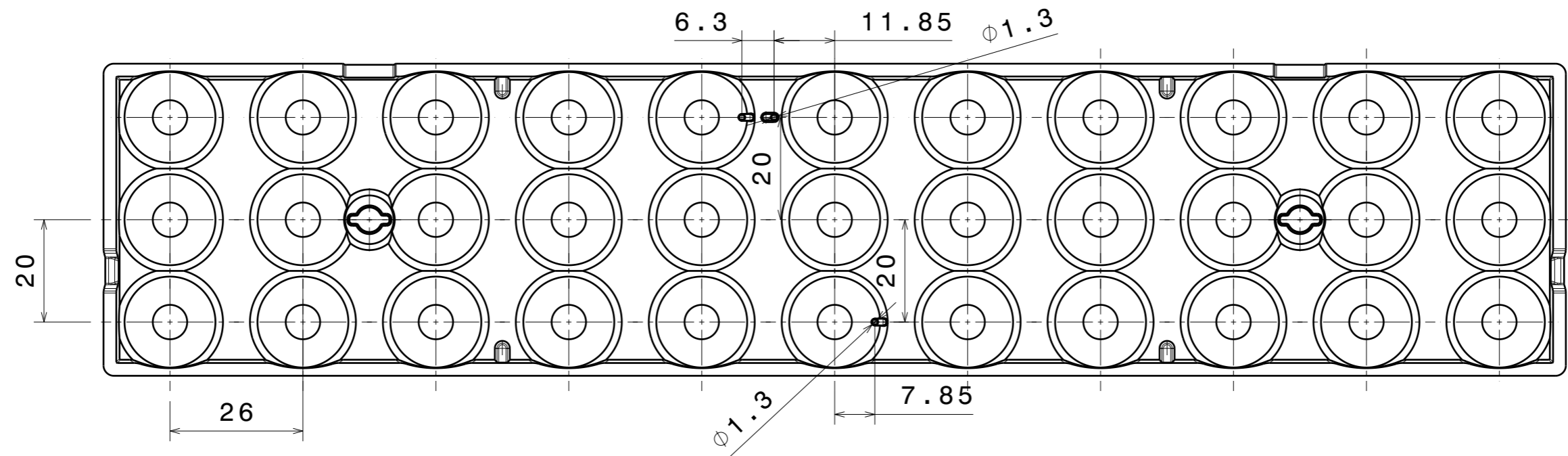

Rear view
Scale: 1:1

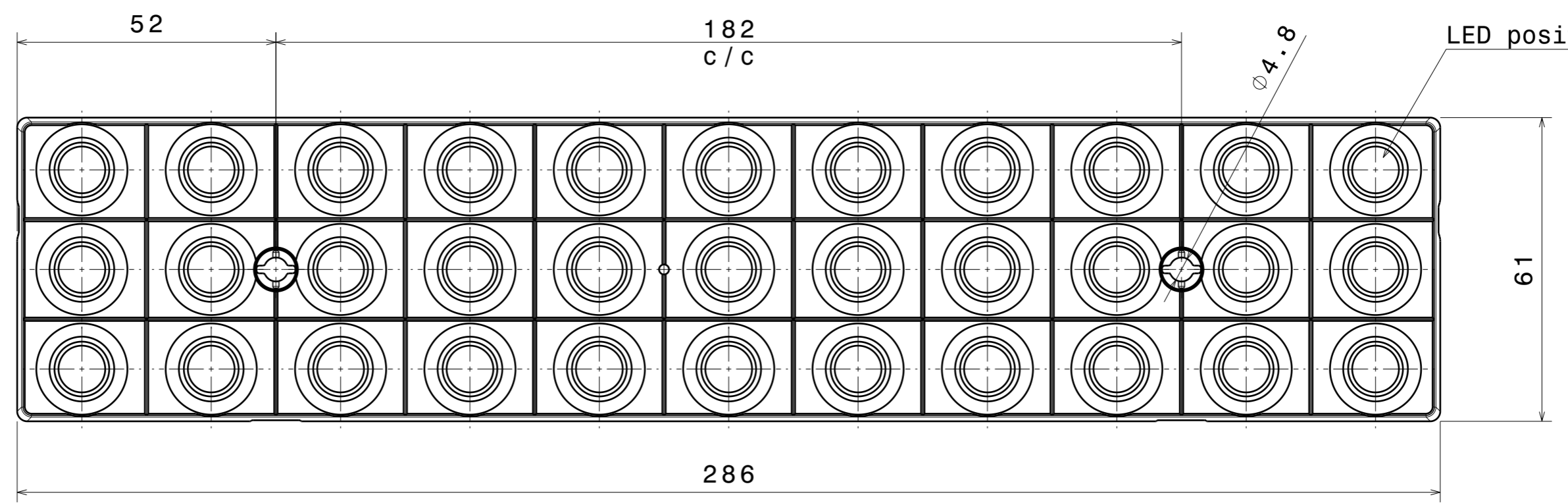

LED positions

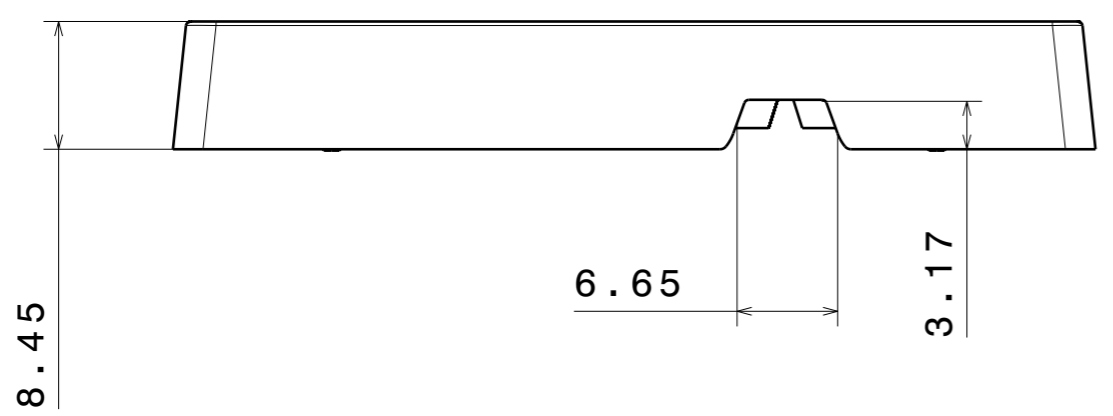

INDEX	PART NO	DESCRIPTION	MATERIAL	COLOUR
1	F14486	FLORENCE-Z30	PMMA	clear

Tolerances if not otherwise shown
According to DIN ISO 2768-1
Linear measures: class M
According to DIN ISO 2768-2
Form and position: class L

LEDiL Ledil Oy
Salorankatu 10
FIN 24240 SALO
Finland

THIRD ANGLE PROJECTION:

DRAWING TITLE
F14486_FLORENCE-Z30

This drawing is the property of LEDiL Oy. It may not be reproduced, copied or communicated without a written agreement with LEDiL Oy.

SIZE	PART NUMBER
A3	F14486

SCALE	1:1	WEIGHT	77 g	SHEET	1/1
-------	-----	--------	------	-------	-----

H G F E D C B A

4

4

3

3

2

2

1

1

H G B A

Luminaire: LEDiL Oy F14486_FLORENCE-Z30_(TRIDINO-R3)_GS

Lamps: 1 x Comet_Electronic sin_TRIDINO-R3-8x0-1100-1ft-HV_1299.6lm@250mA_P=8.07304W_I=0.250A

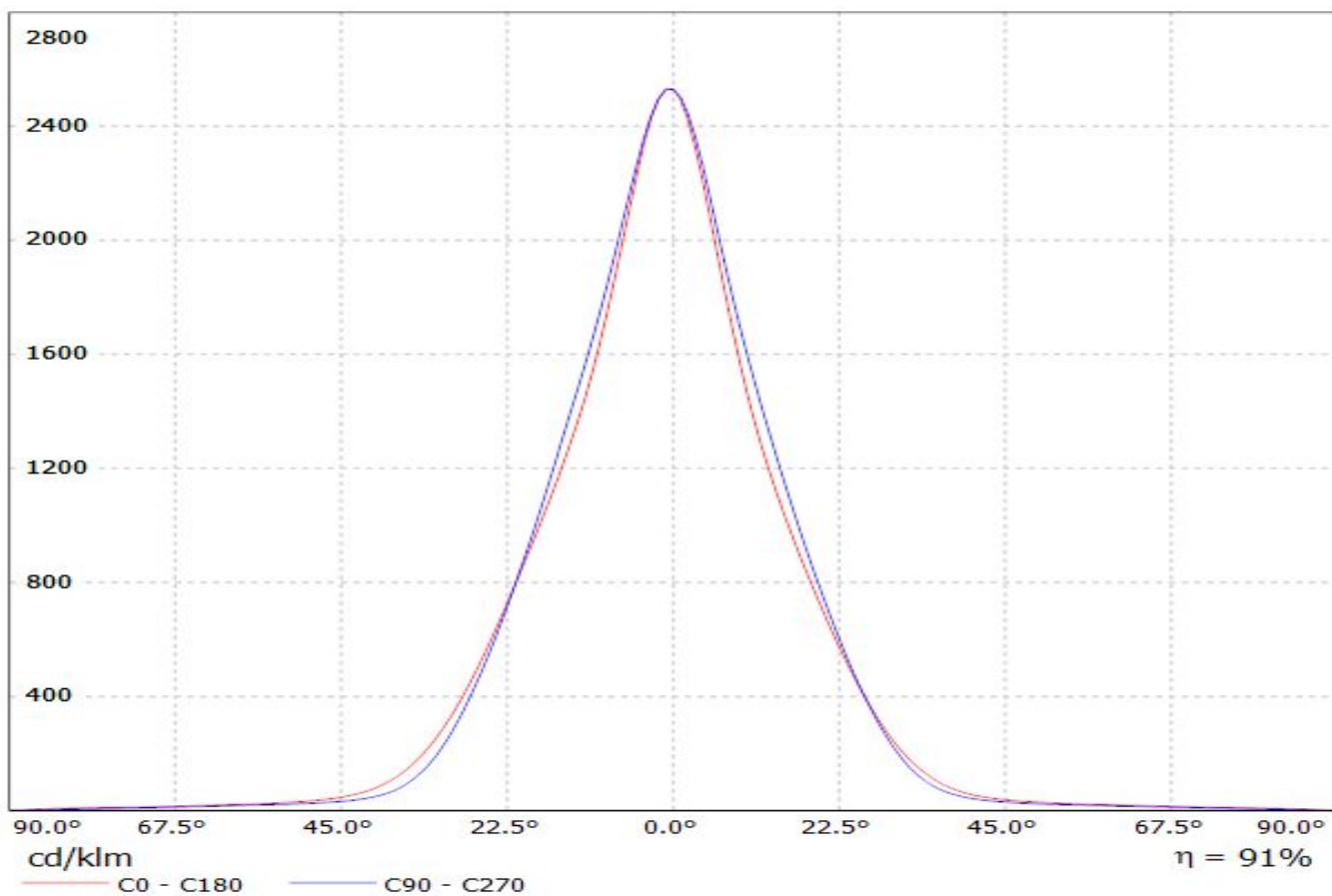

Luminaire: LEDiL Oy F14486_FLORENCE-Z30_(LG_5630)
Lamps: 1 x LG_5630_999.677lm@250mA_P=8.32933W_I=249.8mA

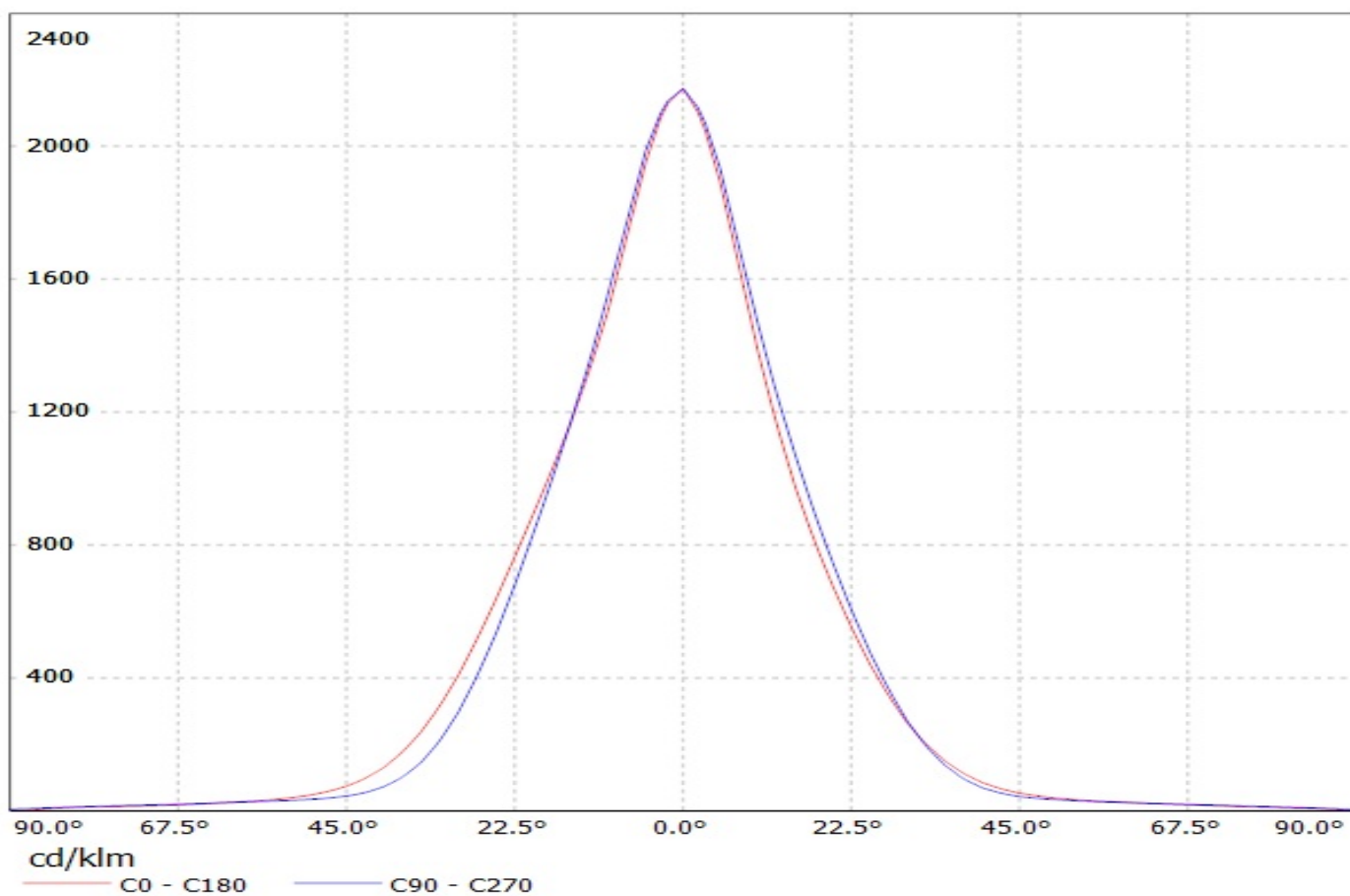

Ledil F14486_FLORENCE-Z30_(Luxeon_3030_2D) / LDC (Linear)

Luminaire: Ledil F14486_FLORENCE-Z30_(Luxeon_3030_2D)
Lamps: 1 x Luxeon_3030_2D_3x11_(L130-4080003000W21)
_1601.44lm@300mA_CCT=4000K_P=12.8W_I=0.3A

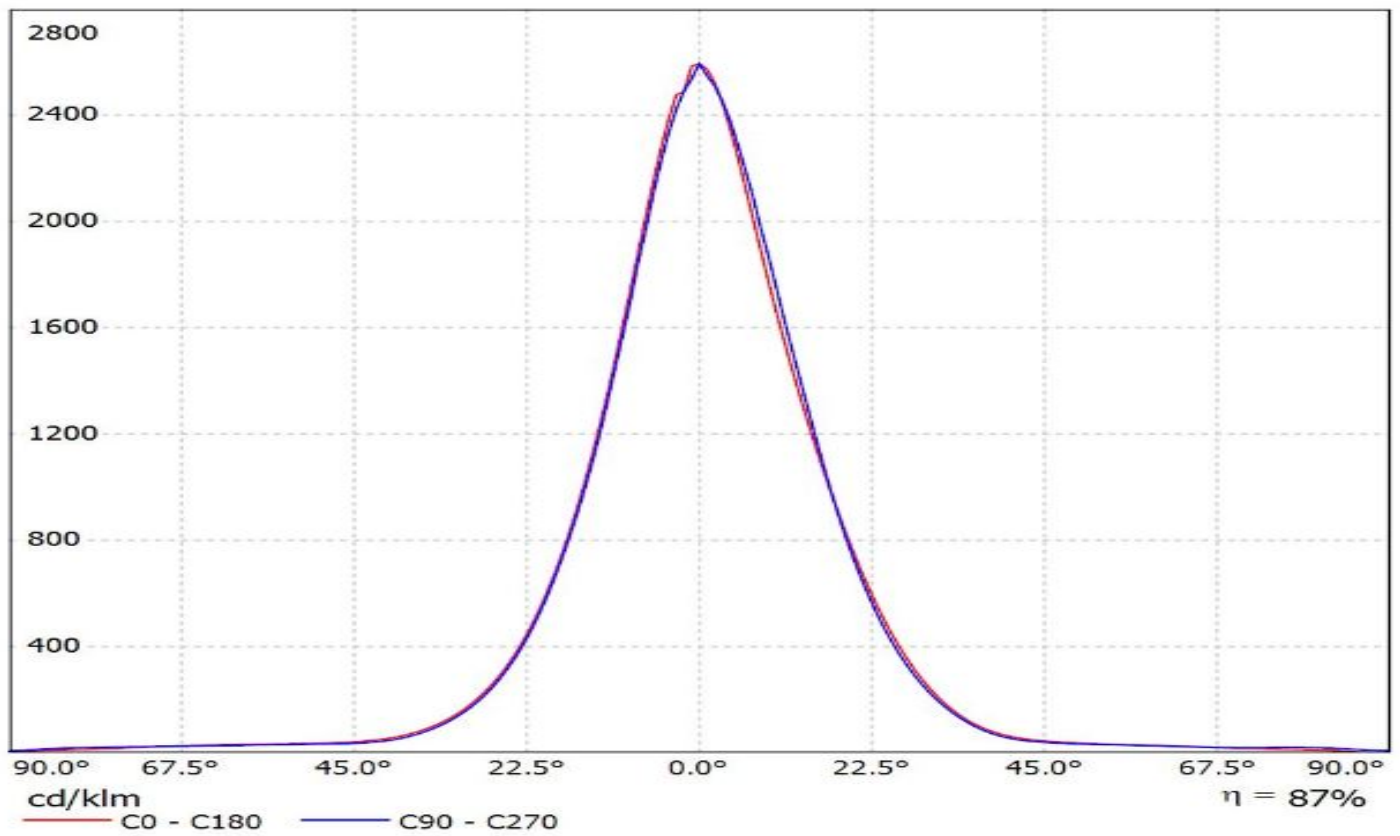

Ledil F14486_FLORENCE-Z30_(Luxeon_XR-3535L) / LDC (Linear)

Luminaire: Ledil F14486_FLORENCE-Z30_(Luxeon_XR-3535L)
Lamps: 1 x Lumileds_Luxeon_XR-3535L_3x11_(L202-3080033C30001)
_1087.37lm@250mA_CCT=3000K_P=8.15W_I=0.25A

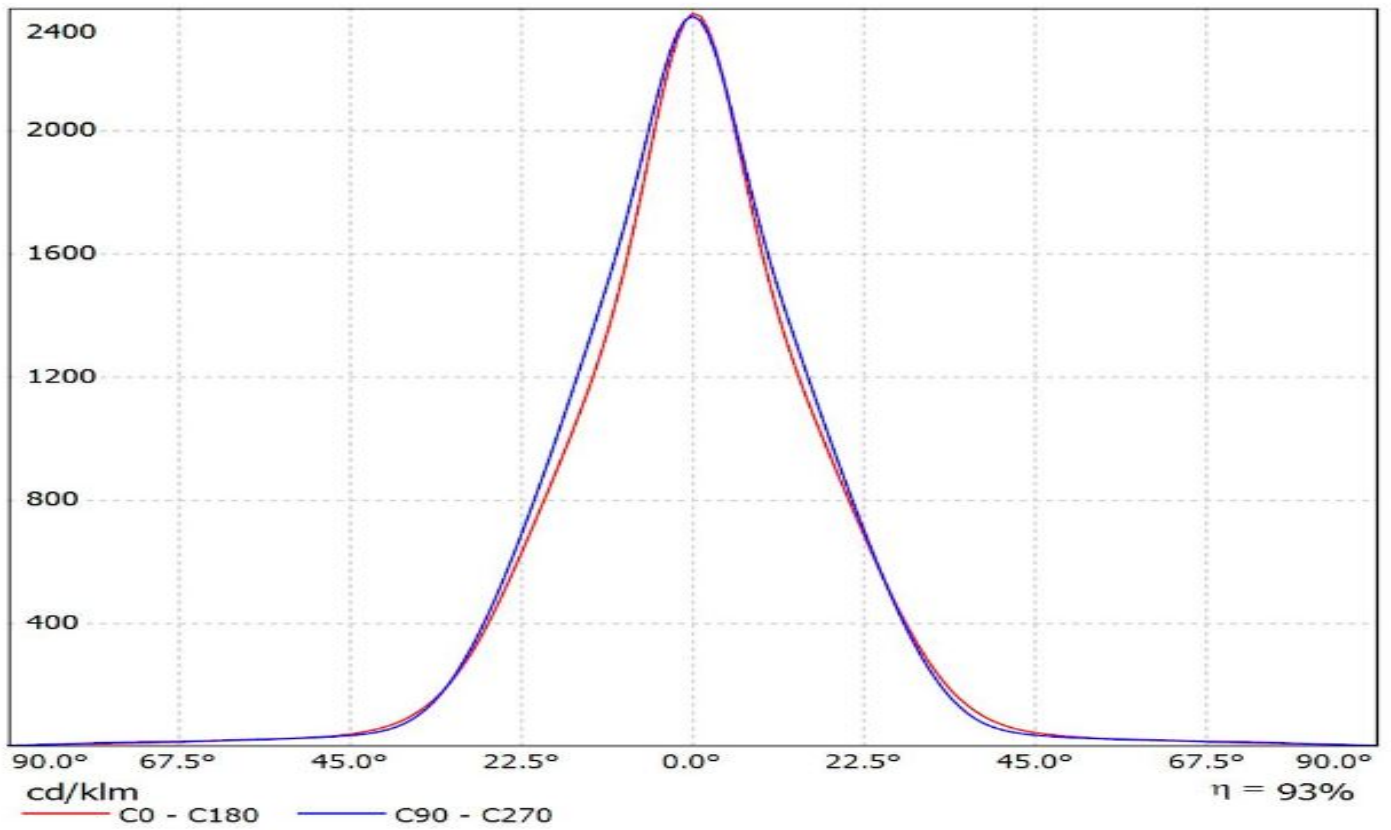

Luminaire: Ledil F14486_FLORENCE-Z30_(Luxeon 3535L HE)
Lamps: 1 x Luxeon 3535L HE 1290.2lm@250mA_P=7.7240W_I=0.25A

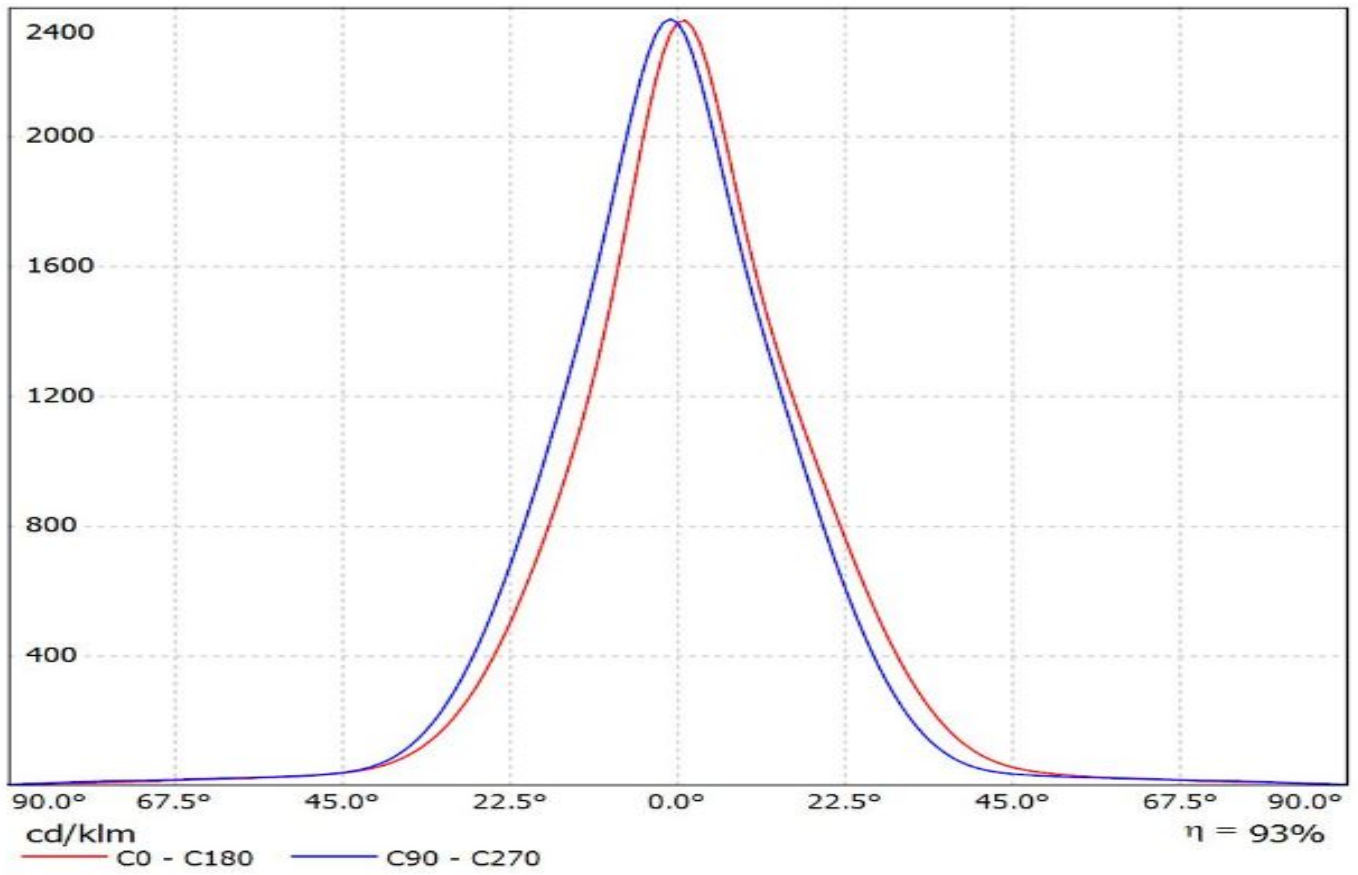

Ledil F14486_FLORENCE-Z30_(MP-2016) / LDC (Linear)

Luminaire: Ledil F14486_FLORENCE-Z30_(MP-2016)

Lamps: 1 x Luminus_MP-2016_x22_(LUMMP-1100-30-80)_715.864lm@180mA_P=6W_I=0.18A

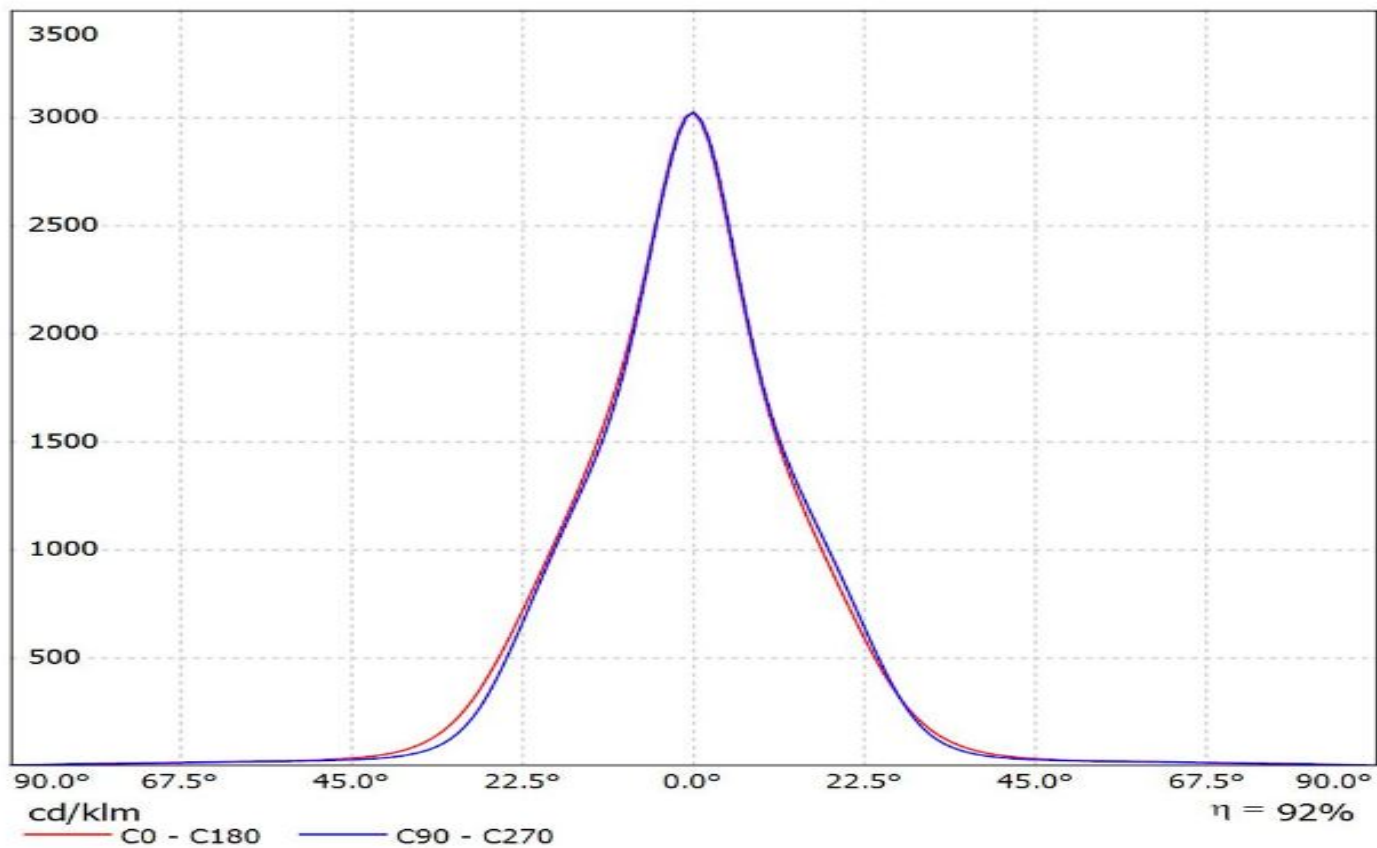

Luminaire: LEDiL Oy F14486_FLORENCE-Z30_(Osram_PLG2-BAR)

Lamps: 1 x Osram_PLG2-BAR -1100-830-280x55-DC_1021.93lm@225mA_P=7.1643W_I=0.225A

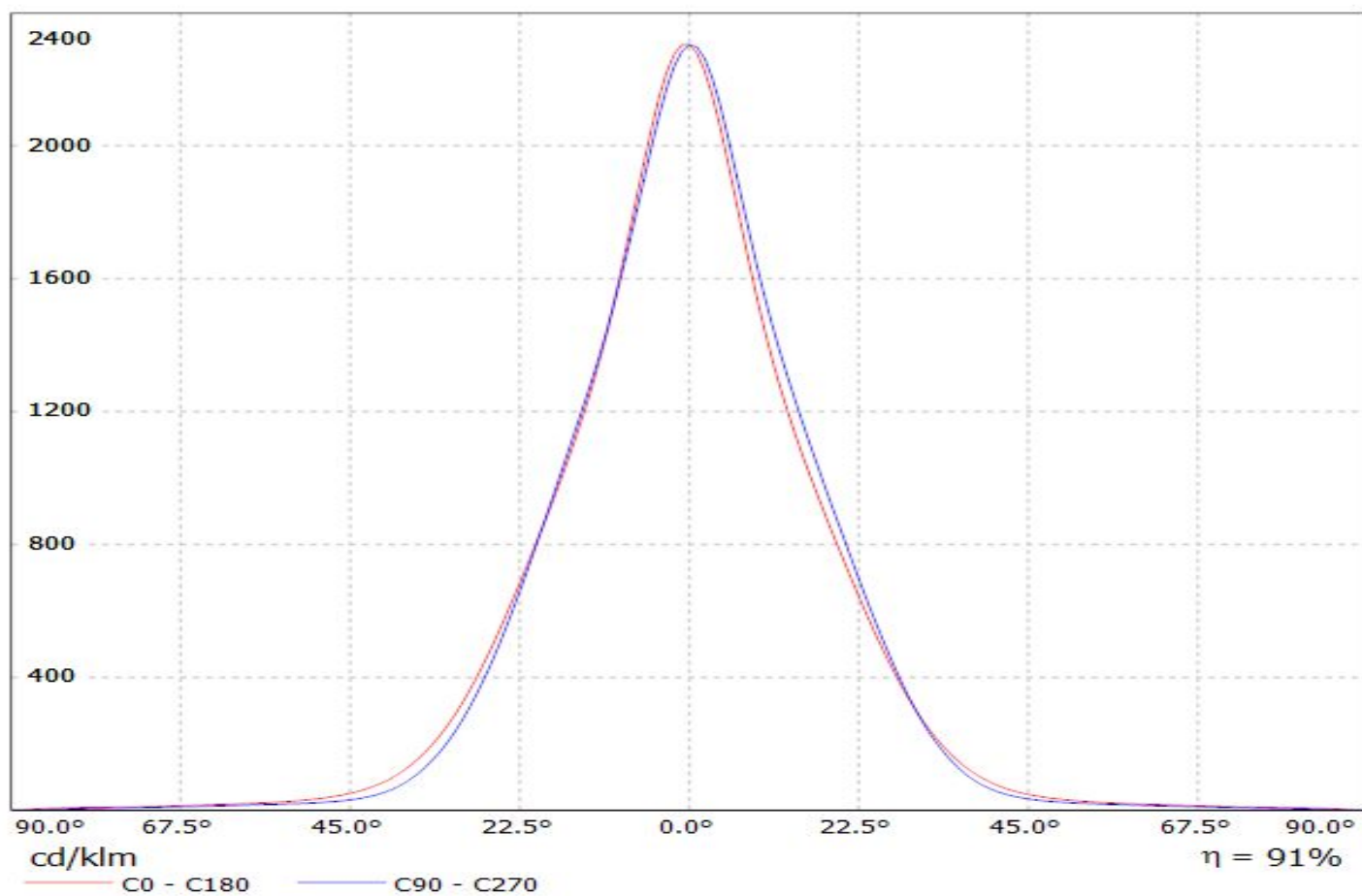

Luminaire: Ledil F14486_FLORENCE-Z30 (Duris_S2)
Lamps: 1 x Osram_Duris-S2_3x11_(GW SBLMA1.EM-GUHQ-XX37-L1N2)
_876.783lm@195mA_CCT=3000K_P=6.3082W_I=0.195A

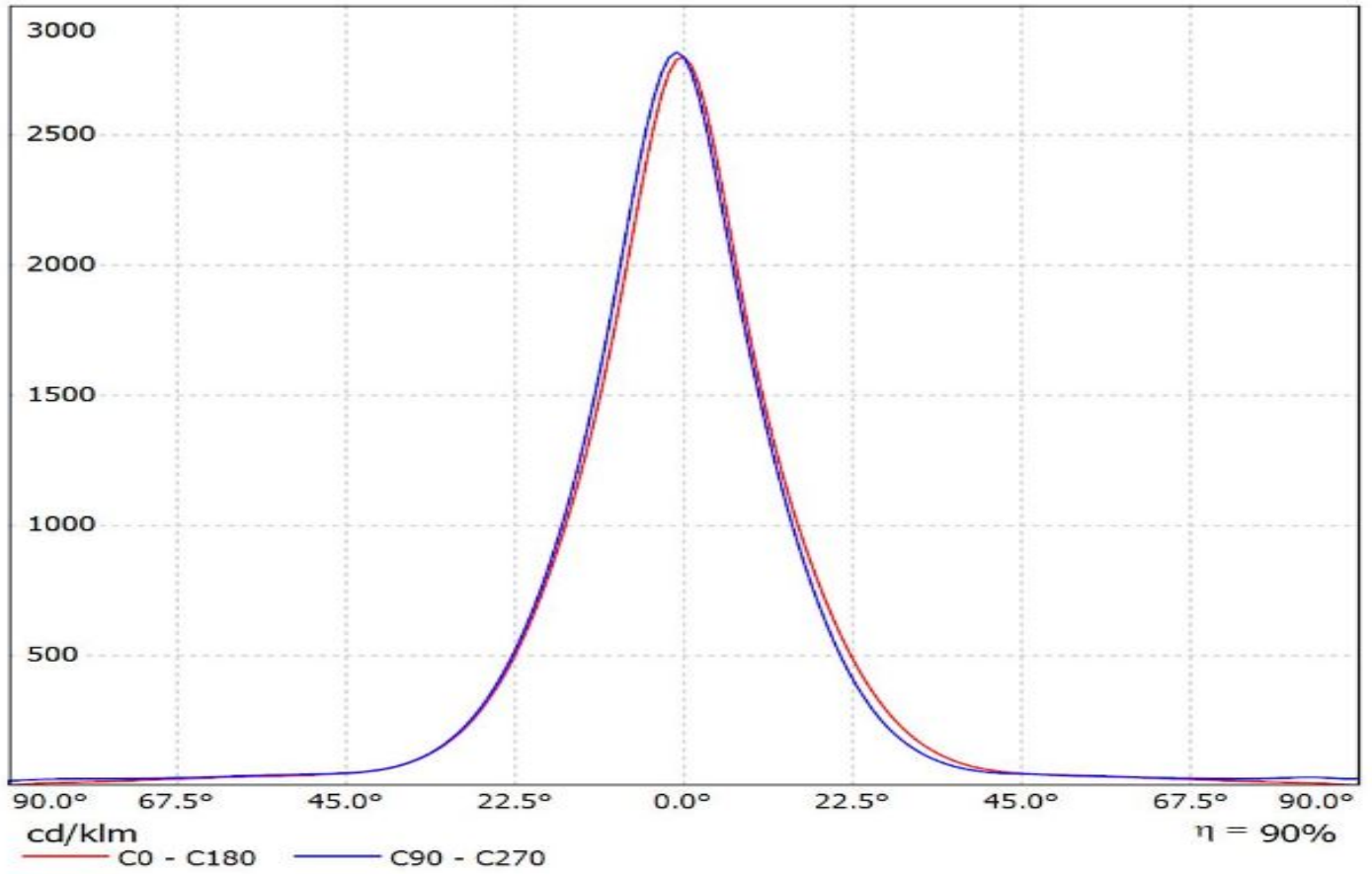

Luminaire: Ledil F14486_FLORENCE_Z30_(DURIS_E5)

Lamps: 1 x Osram_DURIS_E5_584.018lm@120mA_P=3.69708W_I=120mA

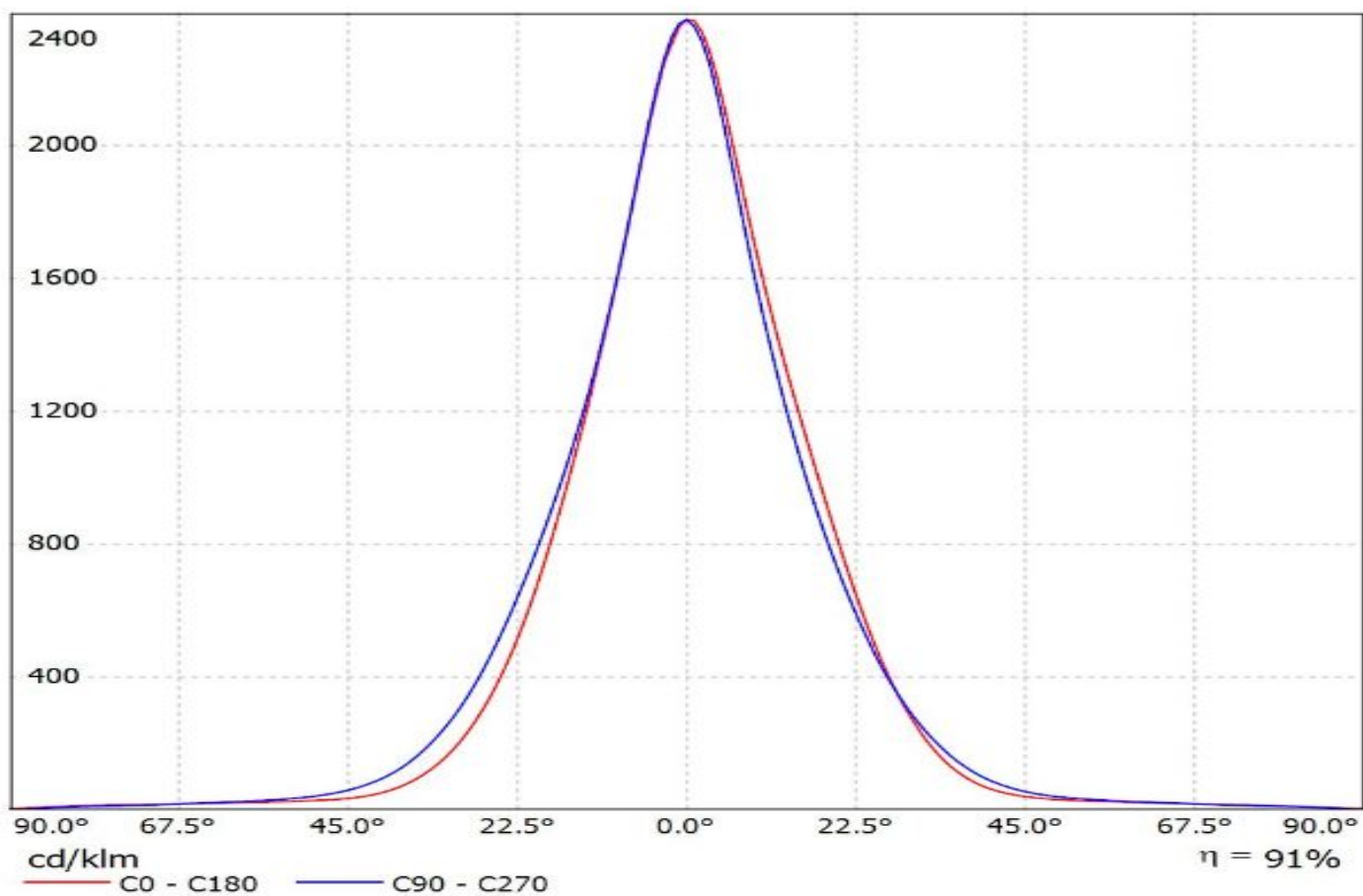

Luminaire: Ledil Oy F14486_FLORENCE-Z30_(Duris_E_2835)_SIMULATED
Lamps: 1 x Osram Duris E 2835 - GW JTLRS1.EM

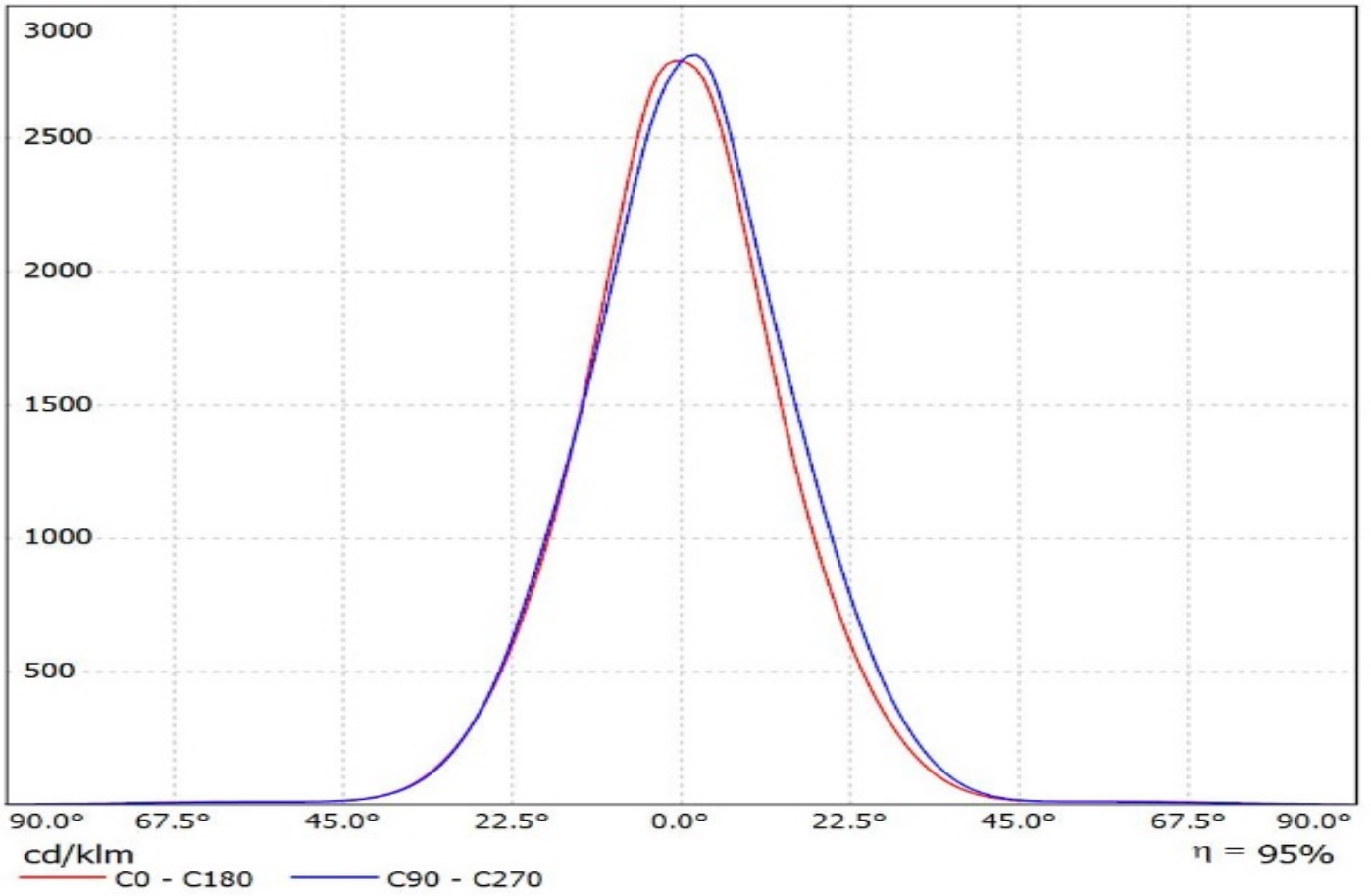

Luminaire: LEDiL Oy F14486_FLORENCE-Z30

Lamps: 1 x (Fortimo 1ft 650lm 8x0 3R xV2 999.677lm@250mA_P=8.32933W_I=249.8mA

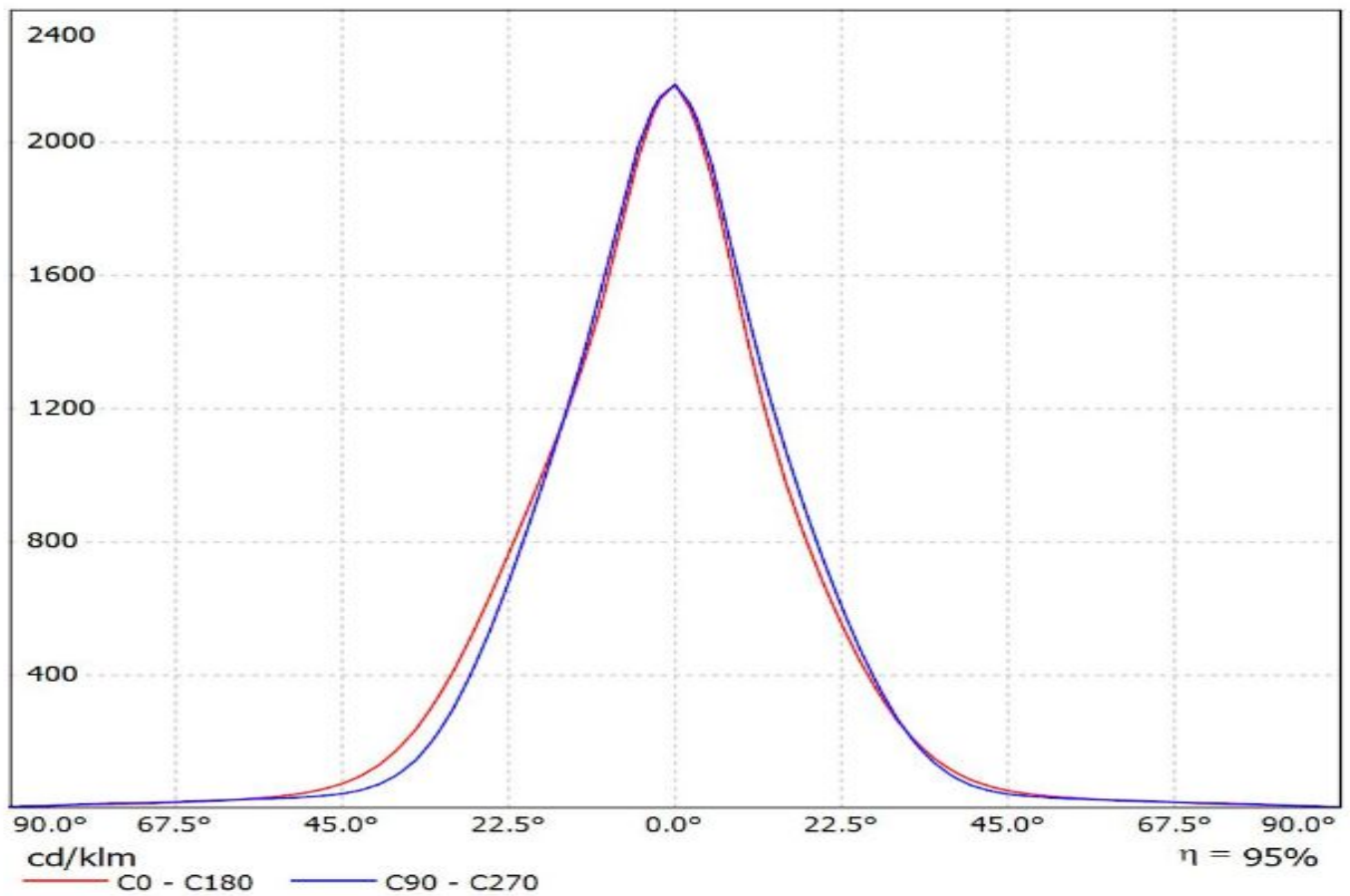

Luminaire: Ledil F14486_FLORENCE-Z30 (Fortimo_LED_Line_3R_1100lm)
Lamps: 1 x Philips_fortimo_3R_1100lm_1080.96lm@250mA_P=7.8857W_I=0.25A

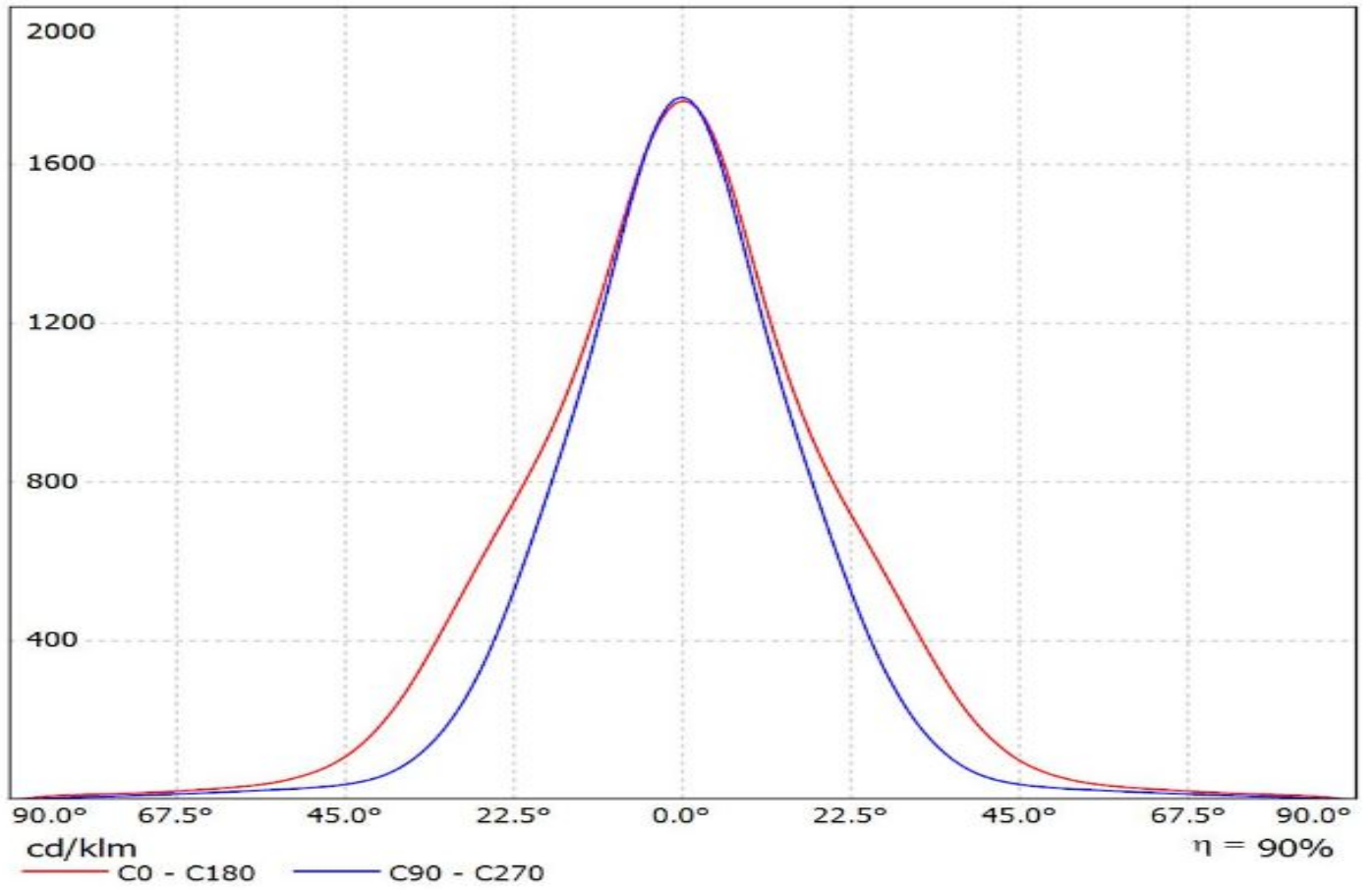

Luminaire: Ledil F14486_FLORENCE-Z30_(Fortimo_LED_Line_1ft_2000lm_8xx_3R_HV2)

Lamps: 1 x Fortimo_LED_Line_1ft_2000lm_8xx_3R_HV2_1229.9lm@250mA_CCT=3000K_P=7.5790W_I=0.25A

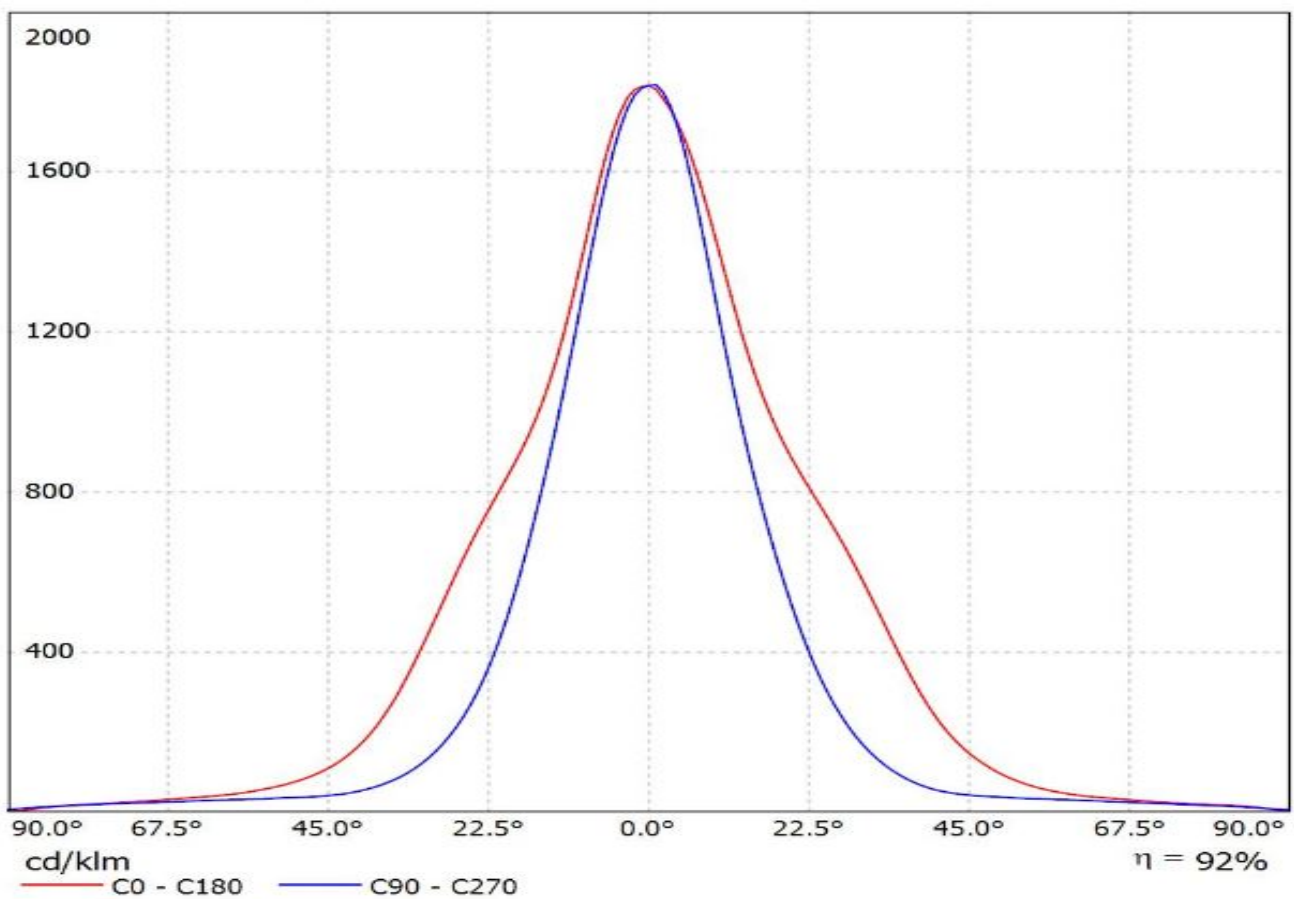

Luminaire: LEDiL Oy F14486_FLORENCE-Z30_(LT-R286A)
Lamps: 1 x Samsung_LT-R286A_1304.7lm@250mA_P=8.2181W_I=0.250A

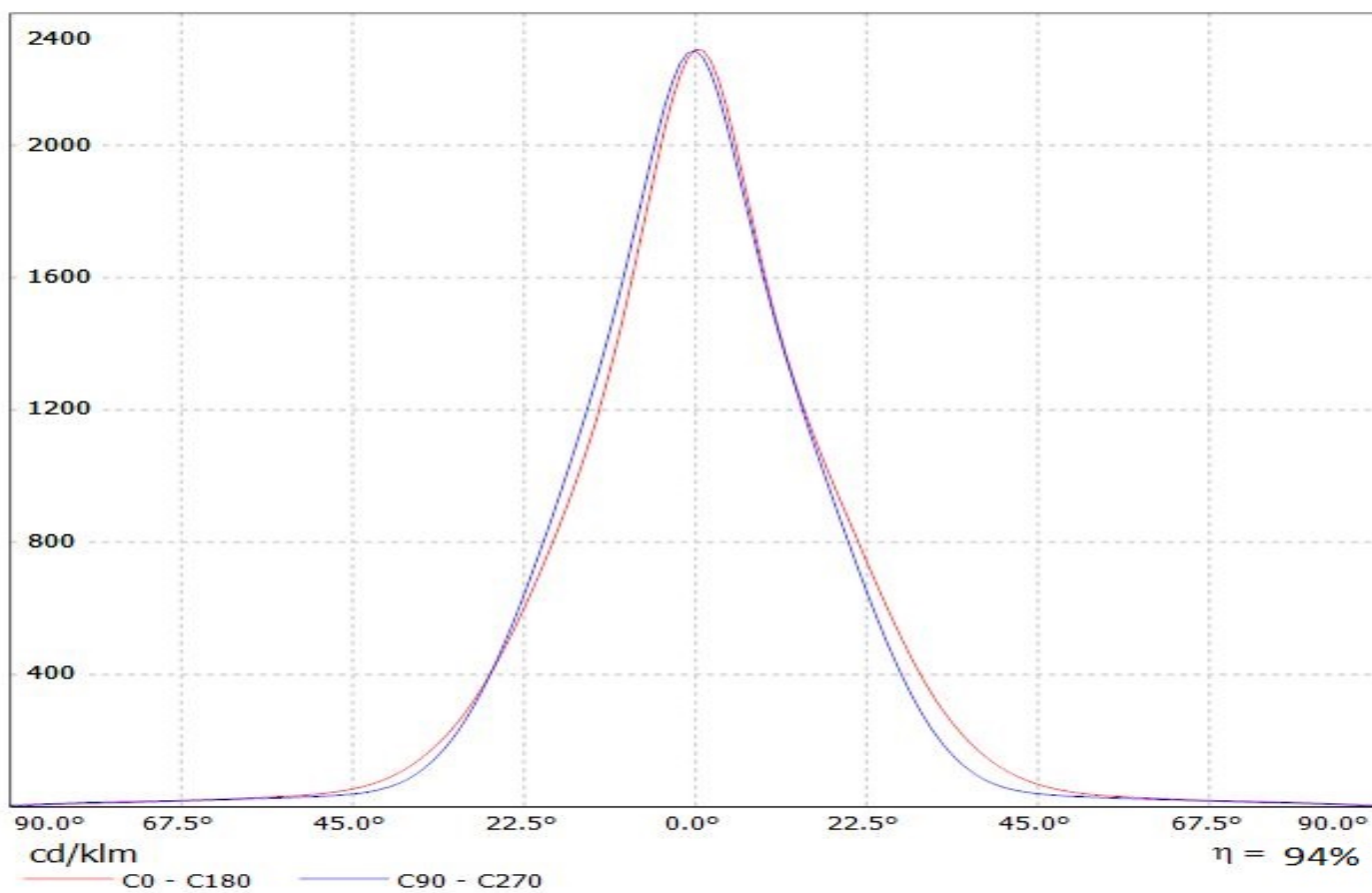

Luminaire: Ledil F14486_FLORENCE-Z30_(LM561B)
Lamps: 1 x Samsung LM561B 1285.07lm@250mA_P=8.0415W_I=0.25A

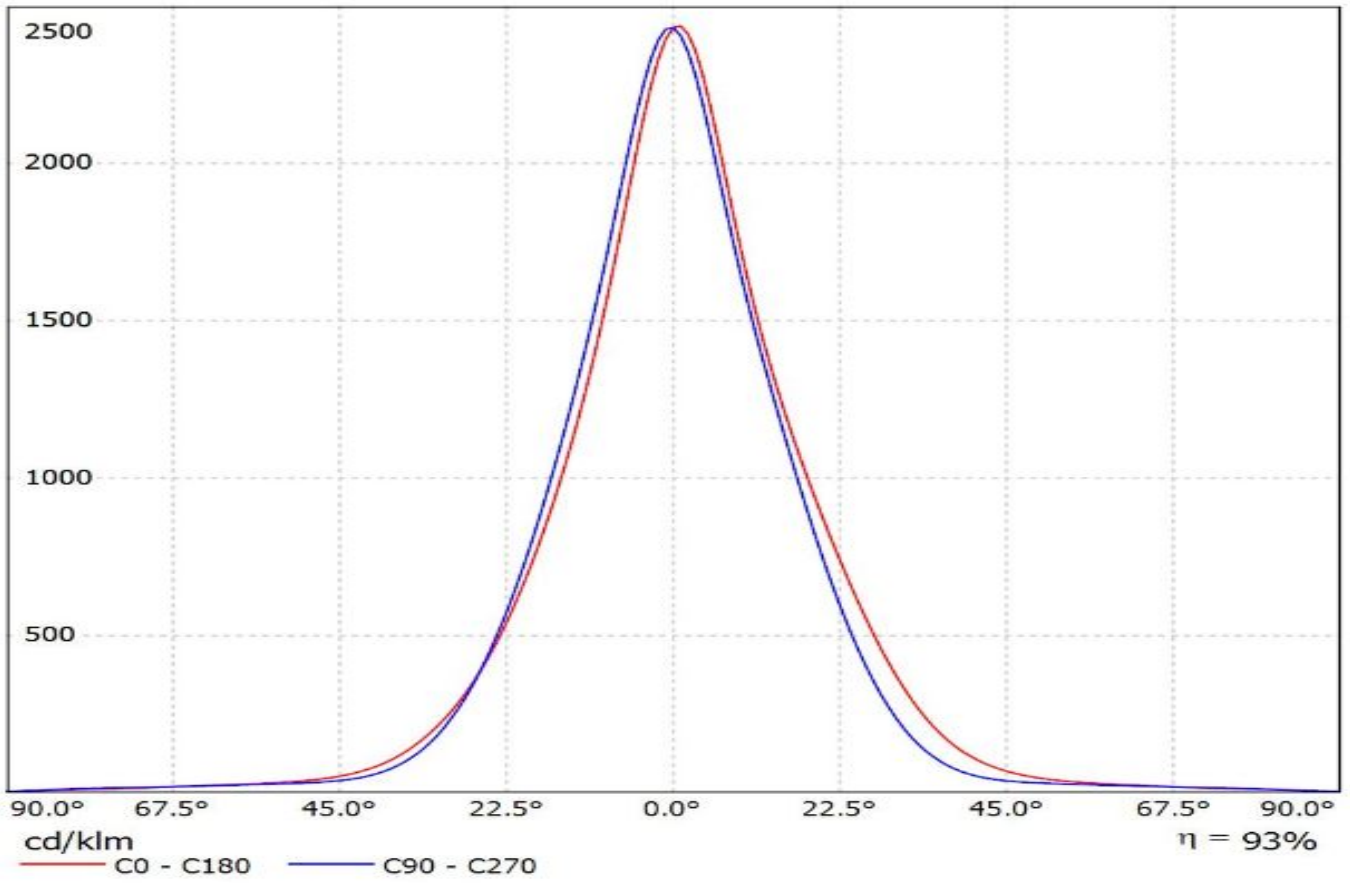

Luminaire: Ledil F14486_FLORENCE-Z30_(LM561C)
Lamps: 1 x Samsung LM561C 1407.48lm@250mA_P=7.7190W_I=0.25A

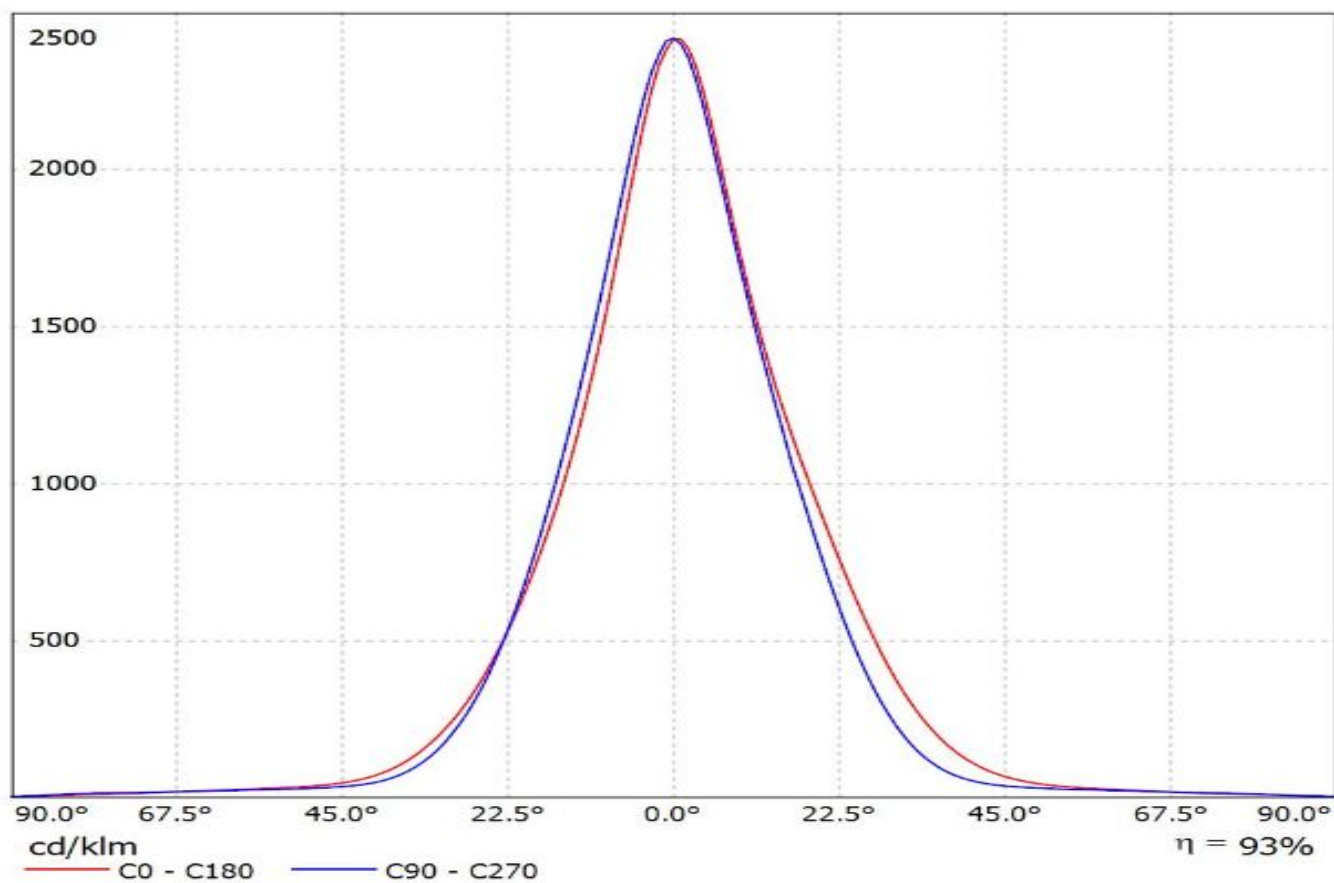

Luminaire: Ledil F14486_FLORENCE-Z30_(LM561B PLUS)
Lamps: 1 x Samsung LM561B PLUS 1366.12lm@250mA_P=8.071W_I=0.25A

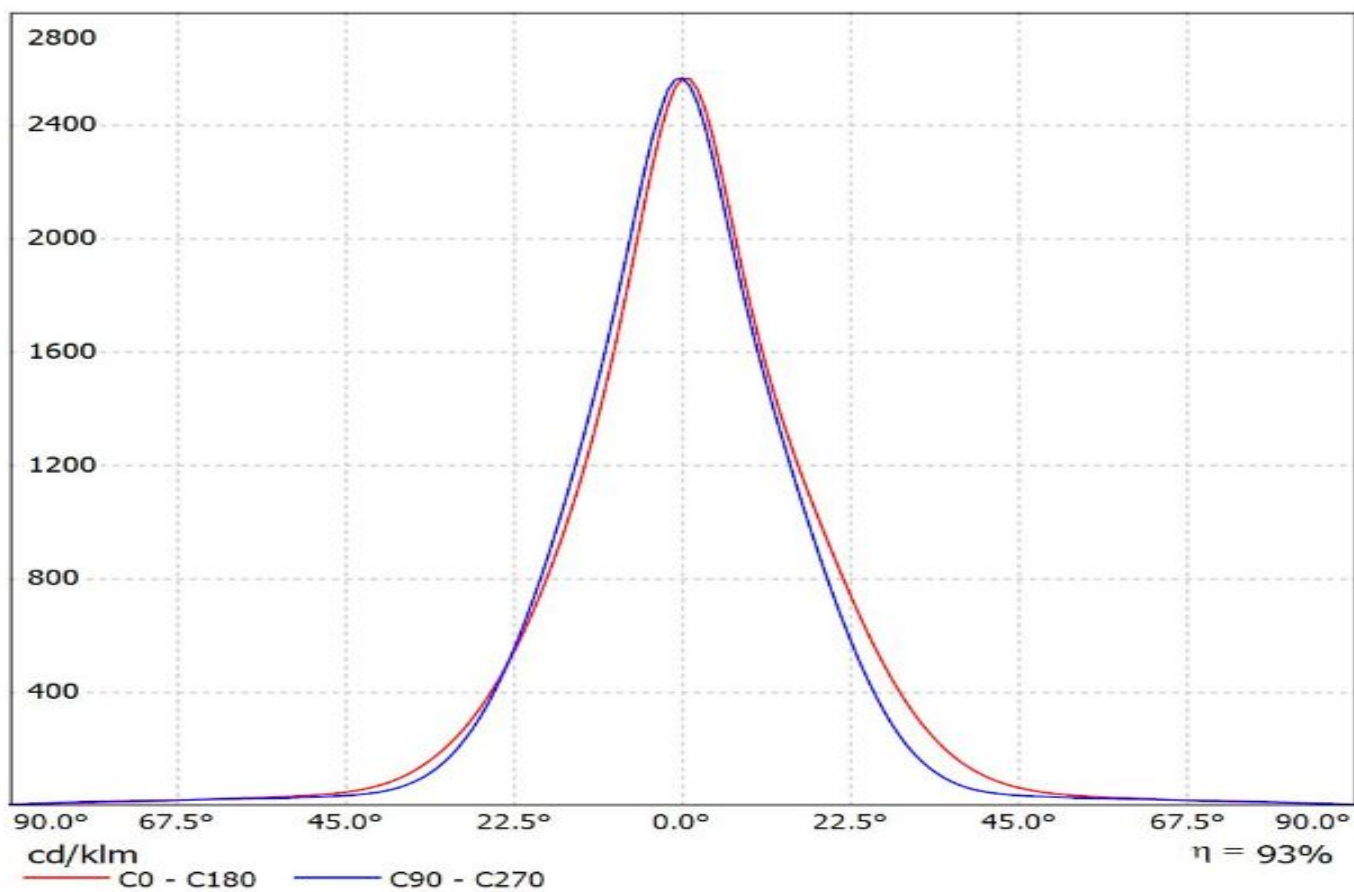

Luminaire: Ledil Oy F14486_FLORENCE-Z30_SEOUL_5630_C_SIMULATED
Lamps: 1 x SEOUL 5630 C

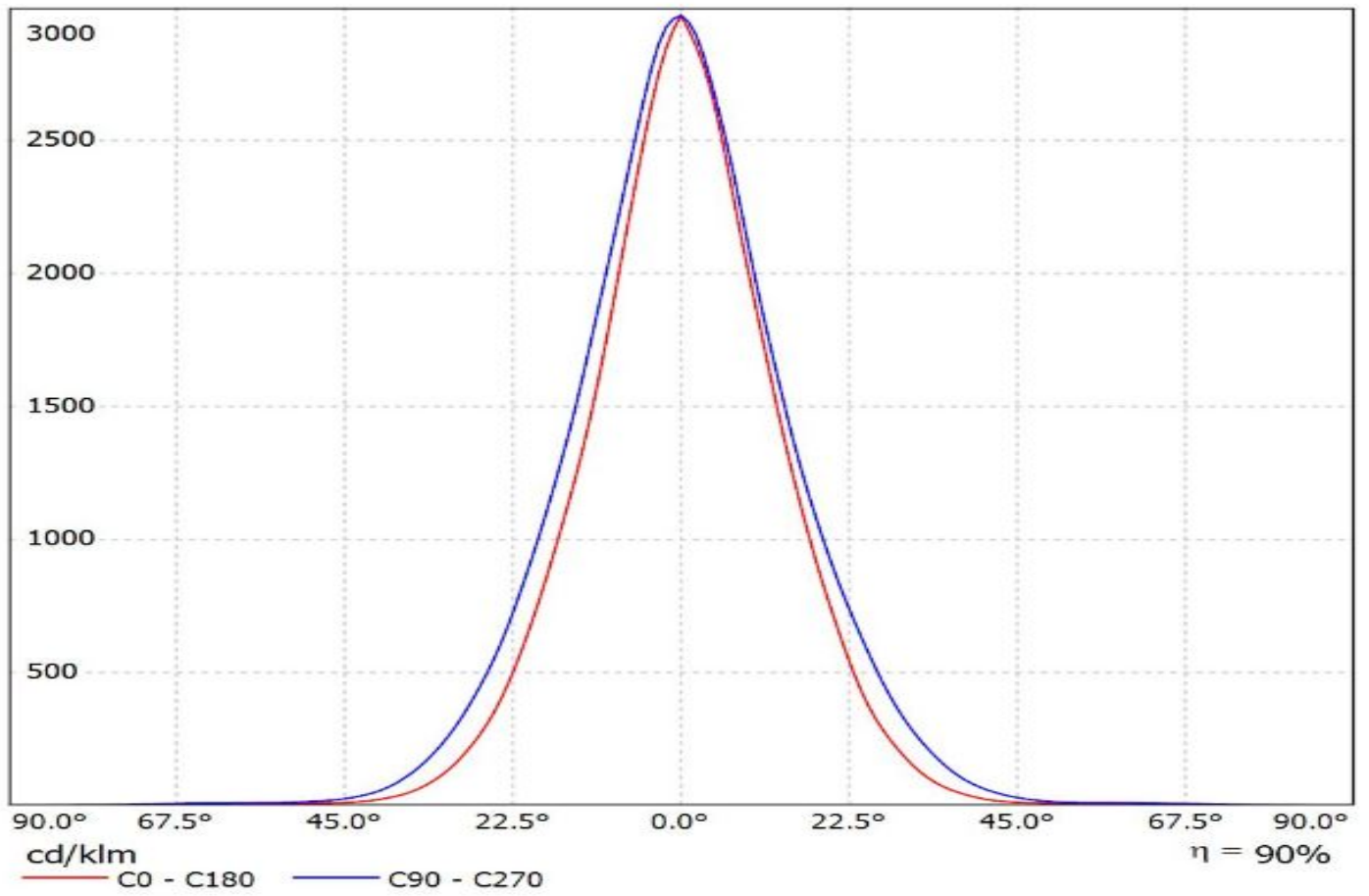

Luminaire: Ledil Oy F14486_FLORENCE-Z30_SEOUL_5630_D_SIMULATED
Lamps: 1 x SEOUL 5630 D

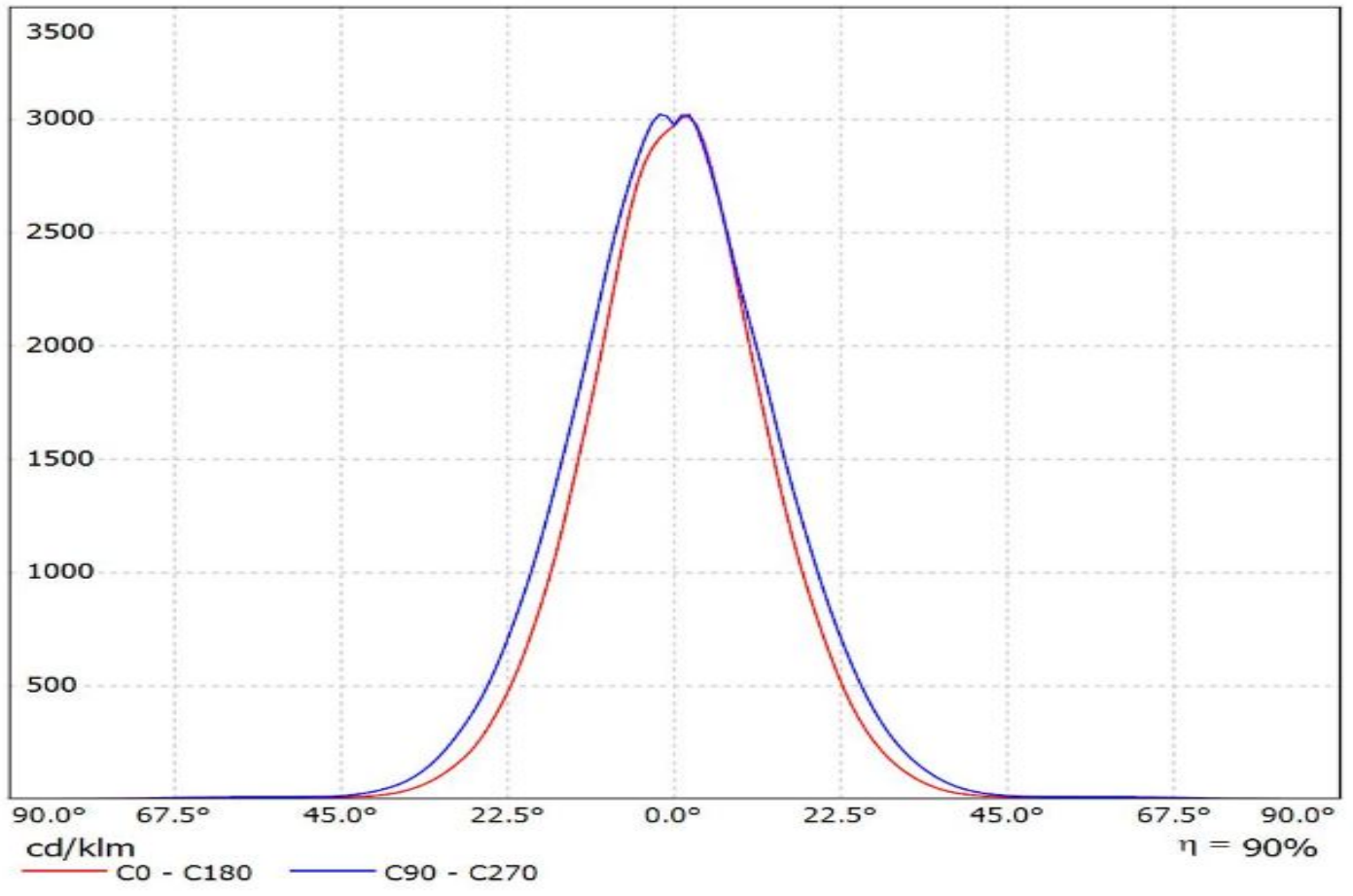

Luminaire: LEDiL Oy F14486_FLORENCE-Z30_(LLE-55-280-1650)

Lamps: 1 x Tridonic_STARK_LLE-55-280-1650_(STARK_LLE-55-280-1650-840-CLA)_1478.34lm@325lm_CCT=4000K_P=10.1908W_I=324.9mA

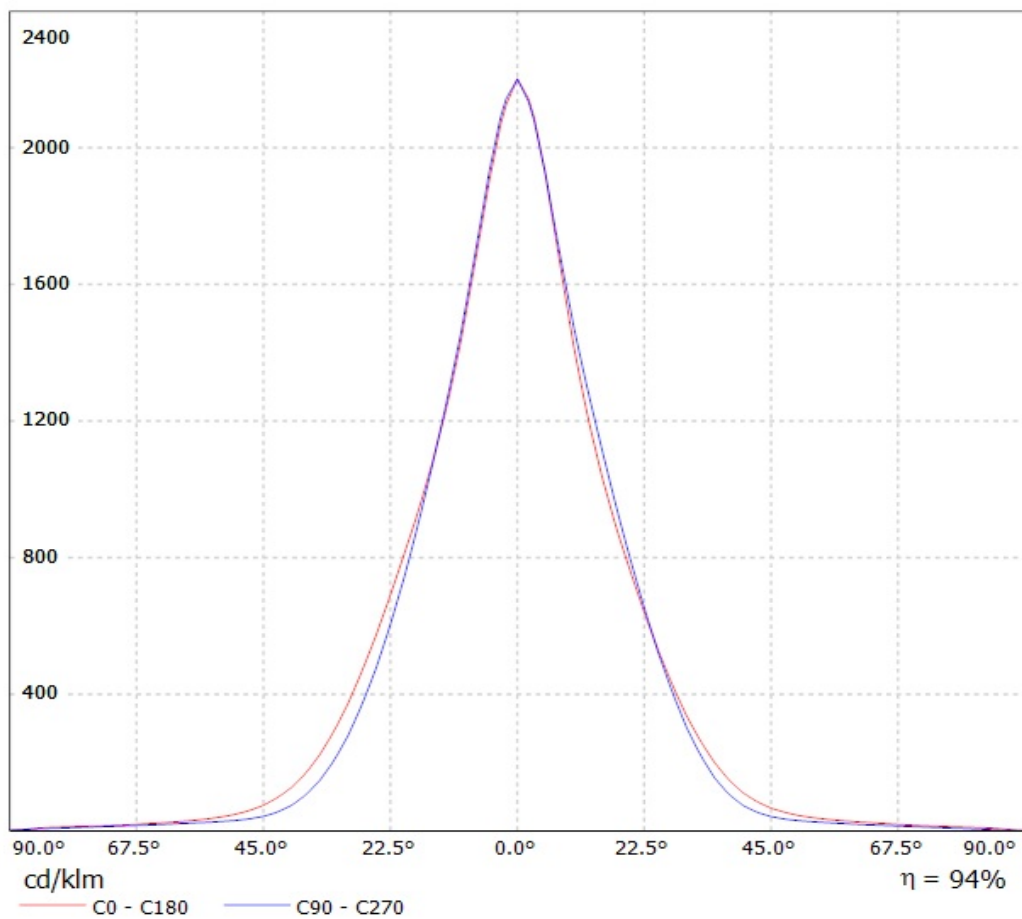

Luminaire: LEDiL Oy F14486_FLORENCE-Z30_(TRIDINO-R3)_GS

Lamps: 1 x Comet_Electronic sin_TRIDINO-R3-8x0-1100-1ft-HV_1299.6lm@250mA_P=8.07304W_I=0.250A

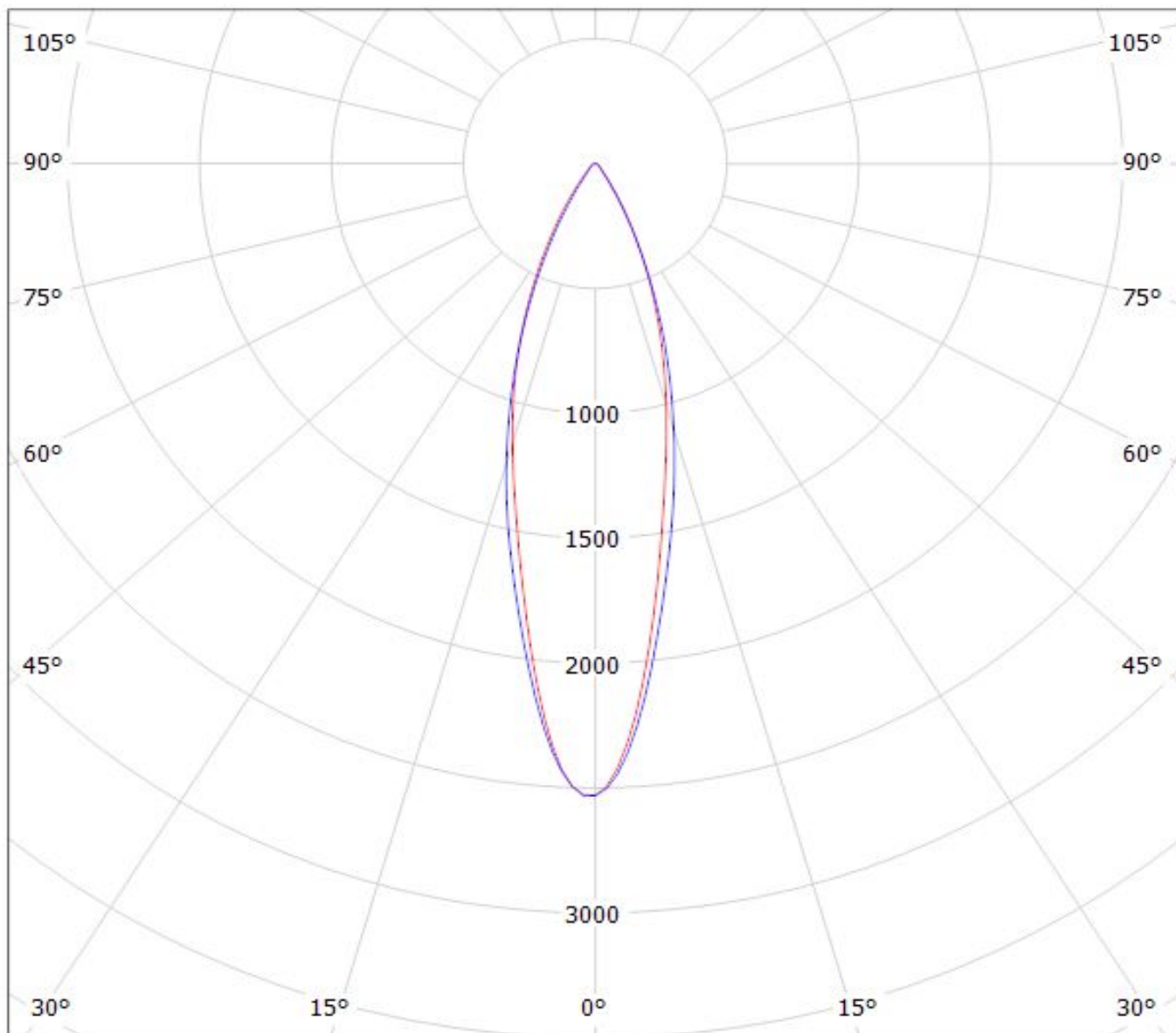

cd/klm

— C0 - C180

— C90 - C270

$\eta = 91\%$

Luminaire: LEDiL Oy F14486_FLORENCE-Z30_(LG_5630)

Lamps: 1 x LG_5630_999.677lm@250mA_P=8.32933W_I=249.8mA

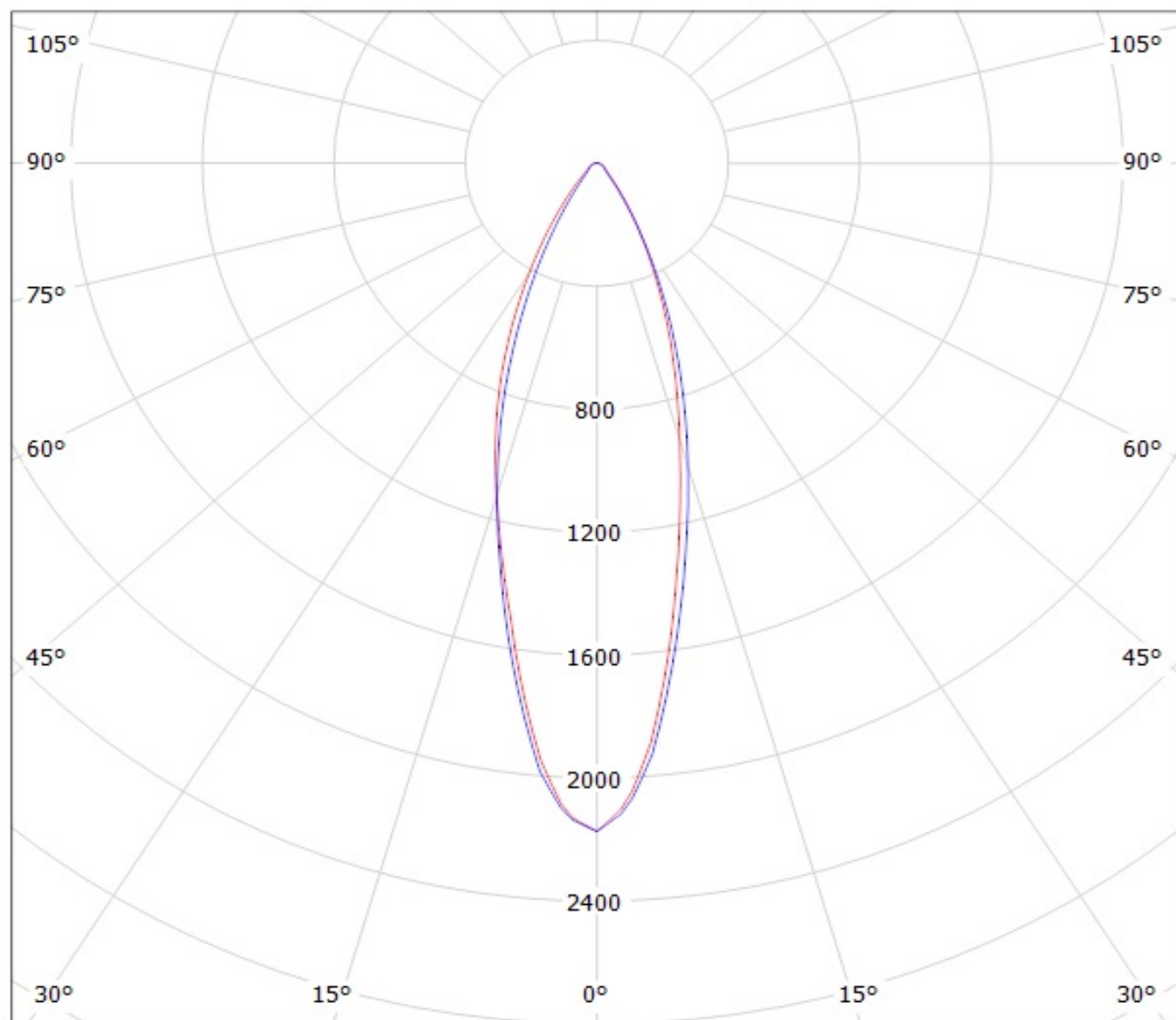

cd/klm

— C0 - C180

— C90 - C270

Ledil F14486_FLORENCE-Z30_(Luxeon_3030_2D) / LDC (Polar)

Luminaire: Ledil F14486_FLORENCE-Z30_(Luxeon_3030_2D)
Lamps: 1 x Luxeon_3030_2D_3x11_(L130-4080003000W21)
_1601.44lm@300mA_CCT=4000K_P=12.8W_I=0.3A

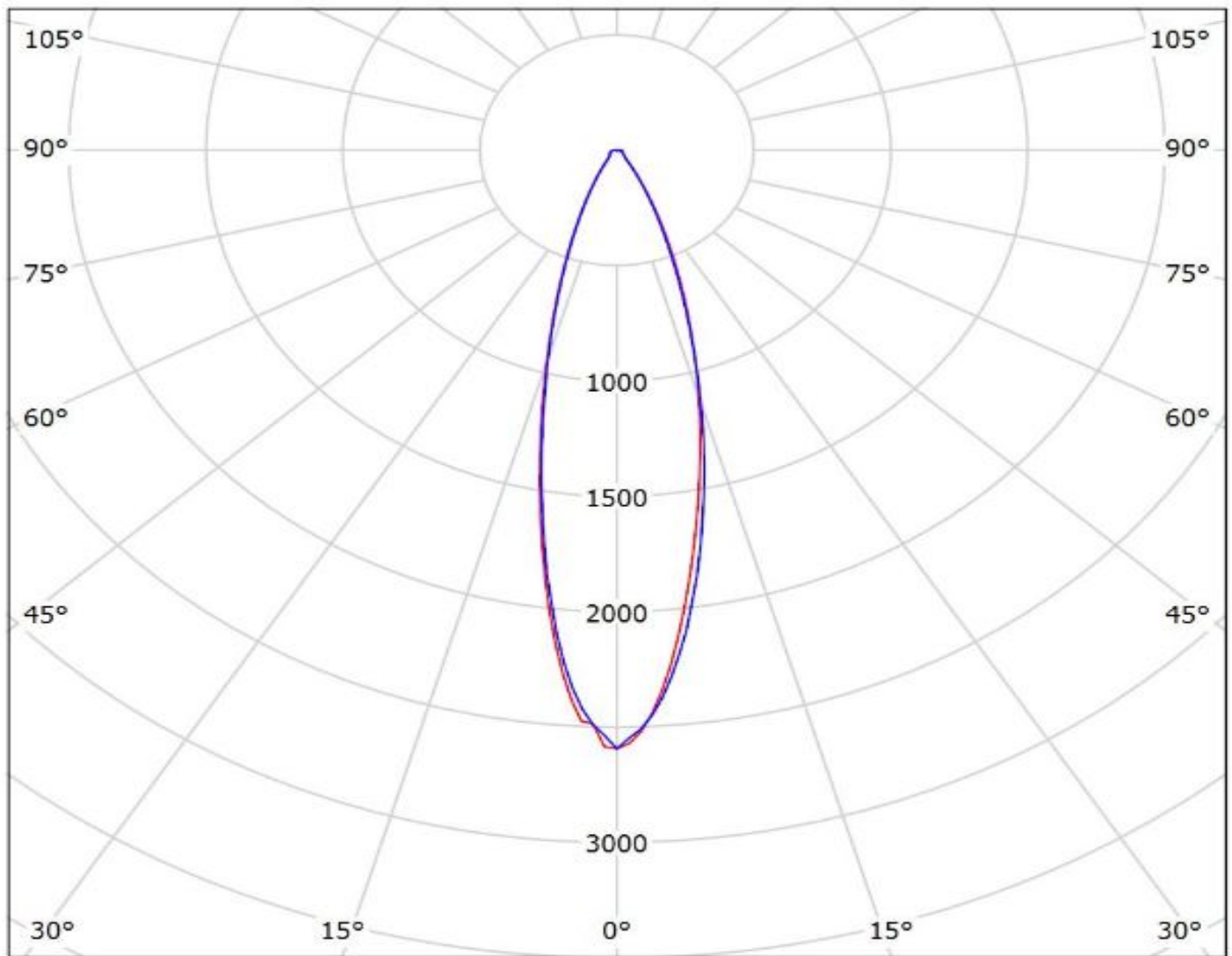

cd/klm

— C0 - C180 — C90 - C270

$\eta = 87\%$

Ledil F14486_FLORENCE-Z30_(Luxeon_XR-3535L) / LDC (Polar)

Luminaire: Ledil F14486_FLORENCE-Z30_(Luxeon_XR-3535L)
Lamps: 1 x Lumileds_Luxeon_XR-3535L_3x11_(L202-3080033C30001)
_1087.37lm@250mA_CCT=3000K_P=8.15W_I=0.25A

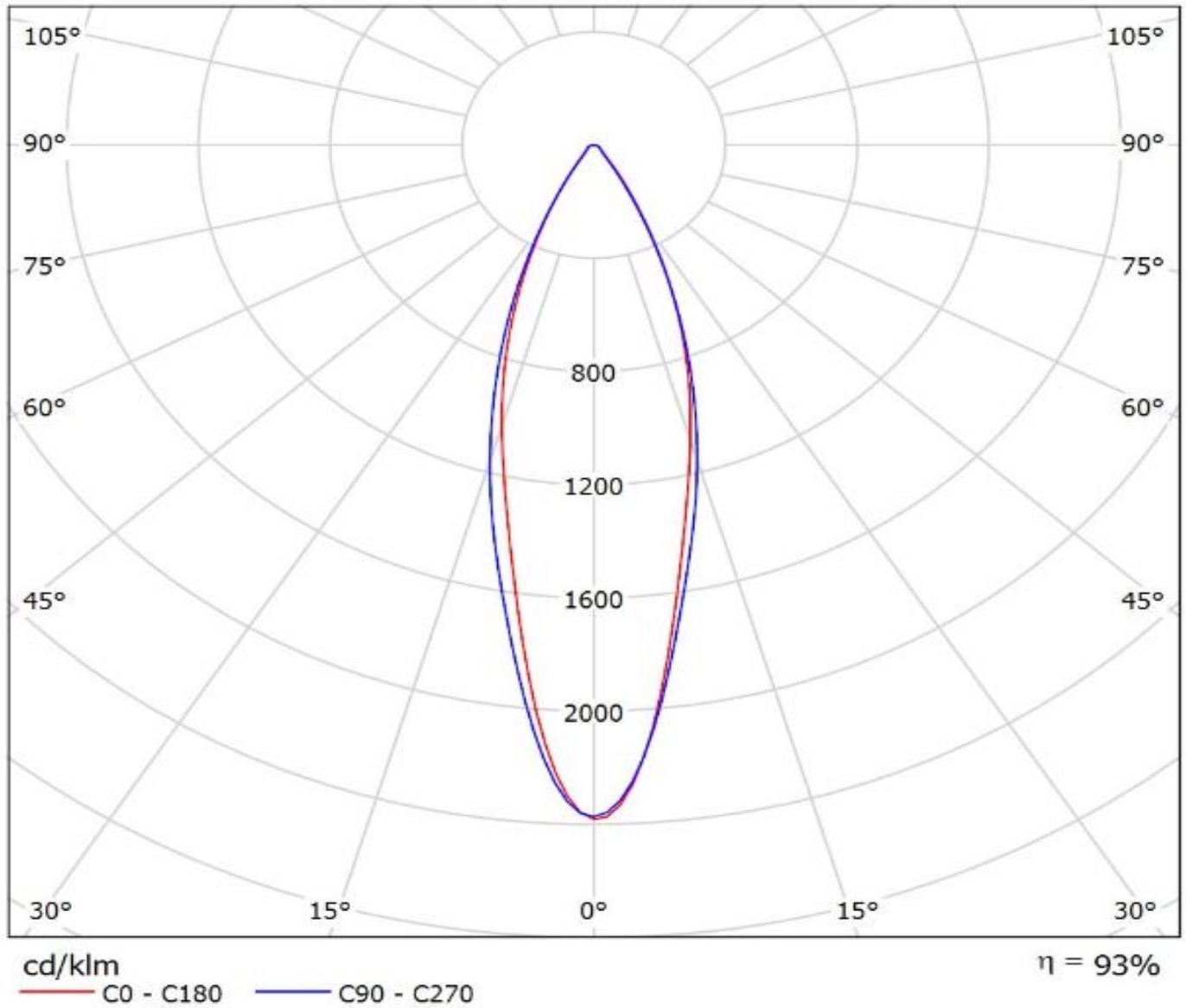

Luminaire: Ledil F14486_FLORENCE-Z30_(Luxeon 3535L HE)
Lamps: 1 x Luxeon 3535L HE 1290.2lm@250mA_P=7.7240W_I=0.25A

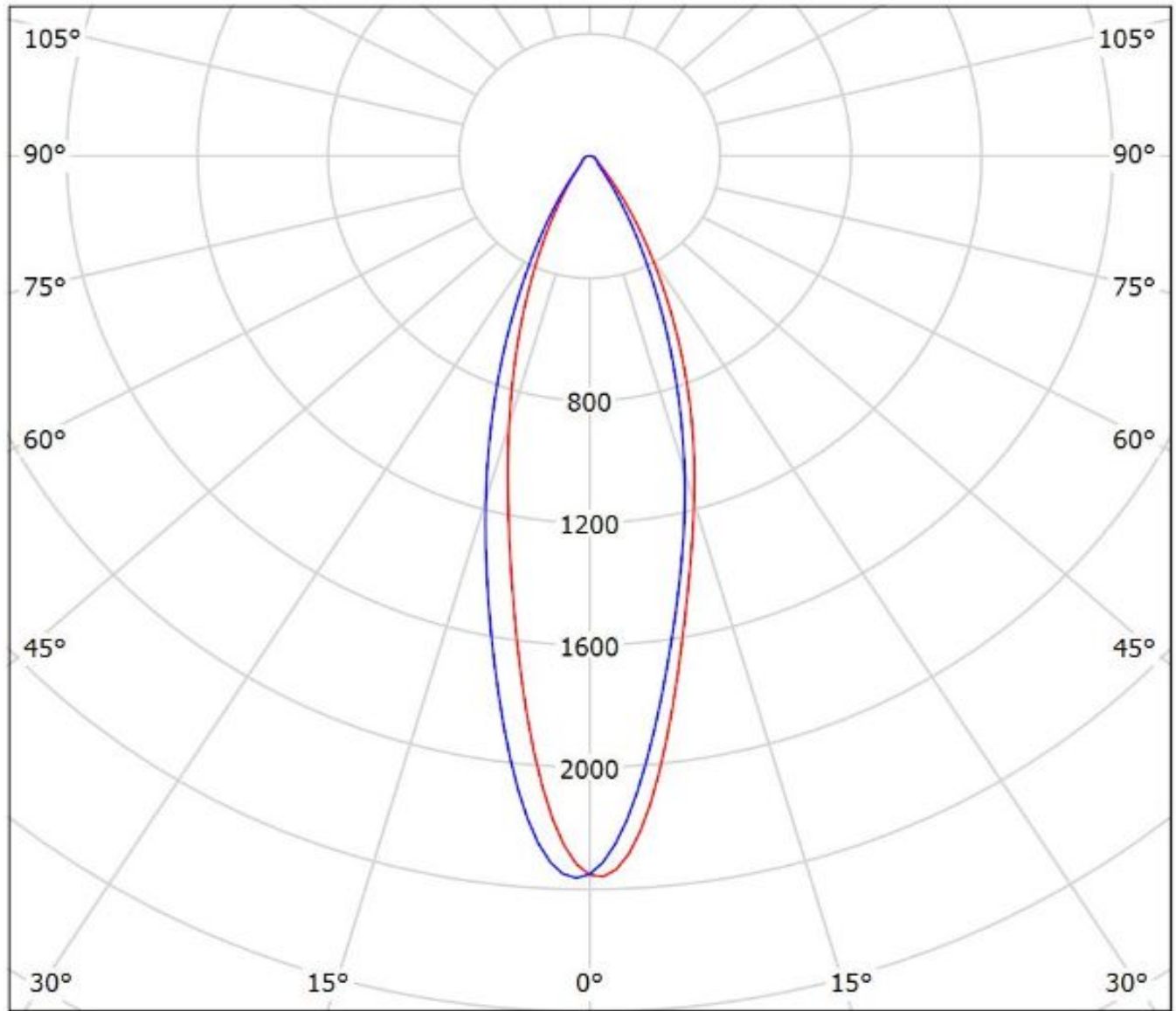

cd/klm
— C0 - C180 — C90 - C270

$\eta = 93\%$

Ledil F14486_FLORENCE-Z30_(MP-2016) / LDC (Polar)

Luminaire: Ledil F14486_FLORENCE-Z30_(MP-2016)

Lamps: 1 x Luminus_MP-2016_x22_(LUMMP-1100-30-80)_715.864lm@180mA_P=6W_I=0.18A

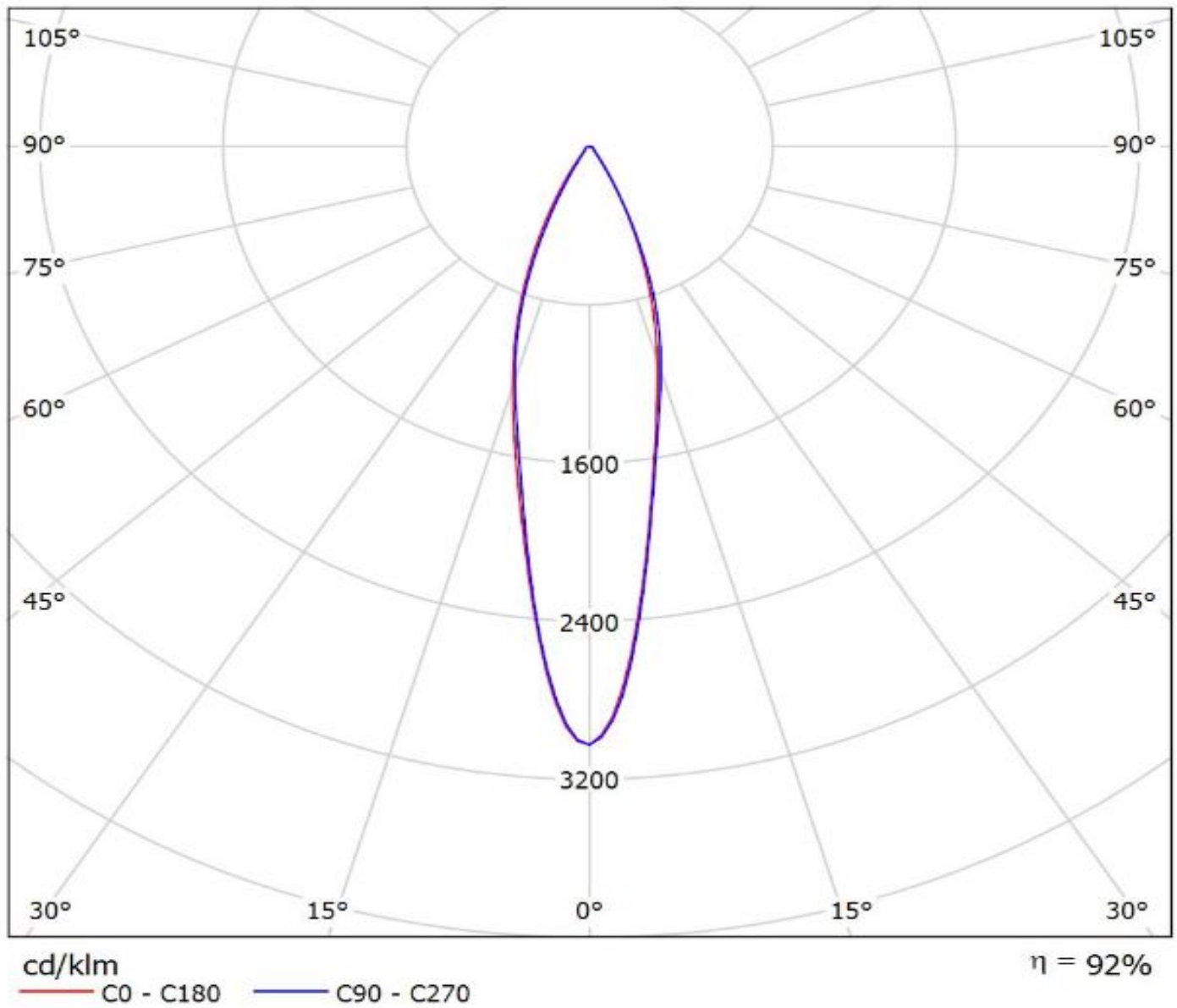

Luminaire: LEDiL Oy F14486_FLORENCE-Z30_(Osram_PLG2-BAR)

Lamps: 1 x Osram_PLG2-BAR -1100-830-280x55-DC_1021.93lm@225mA_P=7.1643W_I=0.225A

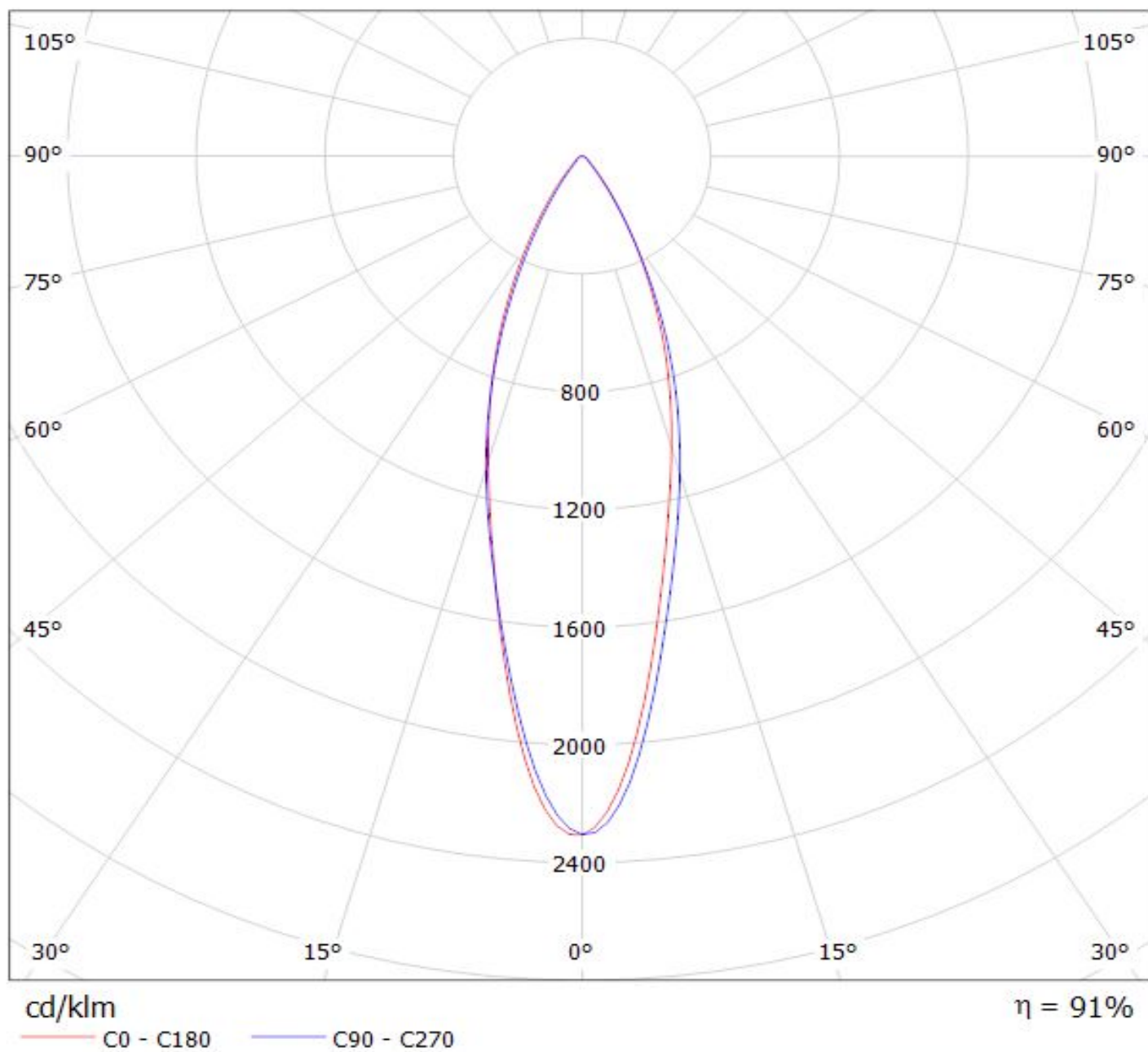

Luminaire: Ledil F14486_FLORENCE-Z30_(Duris_S2)
Lamps: 1 x Osram_Duris-S2_3x11_(GW SBLMA1.EM-GUHQ-XX37-L1N2)
_876.783lm@195mA_CCT=3000K_P=6.3082W_I=0.195A

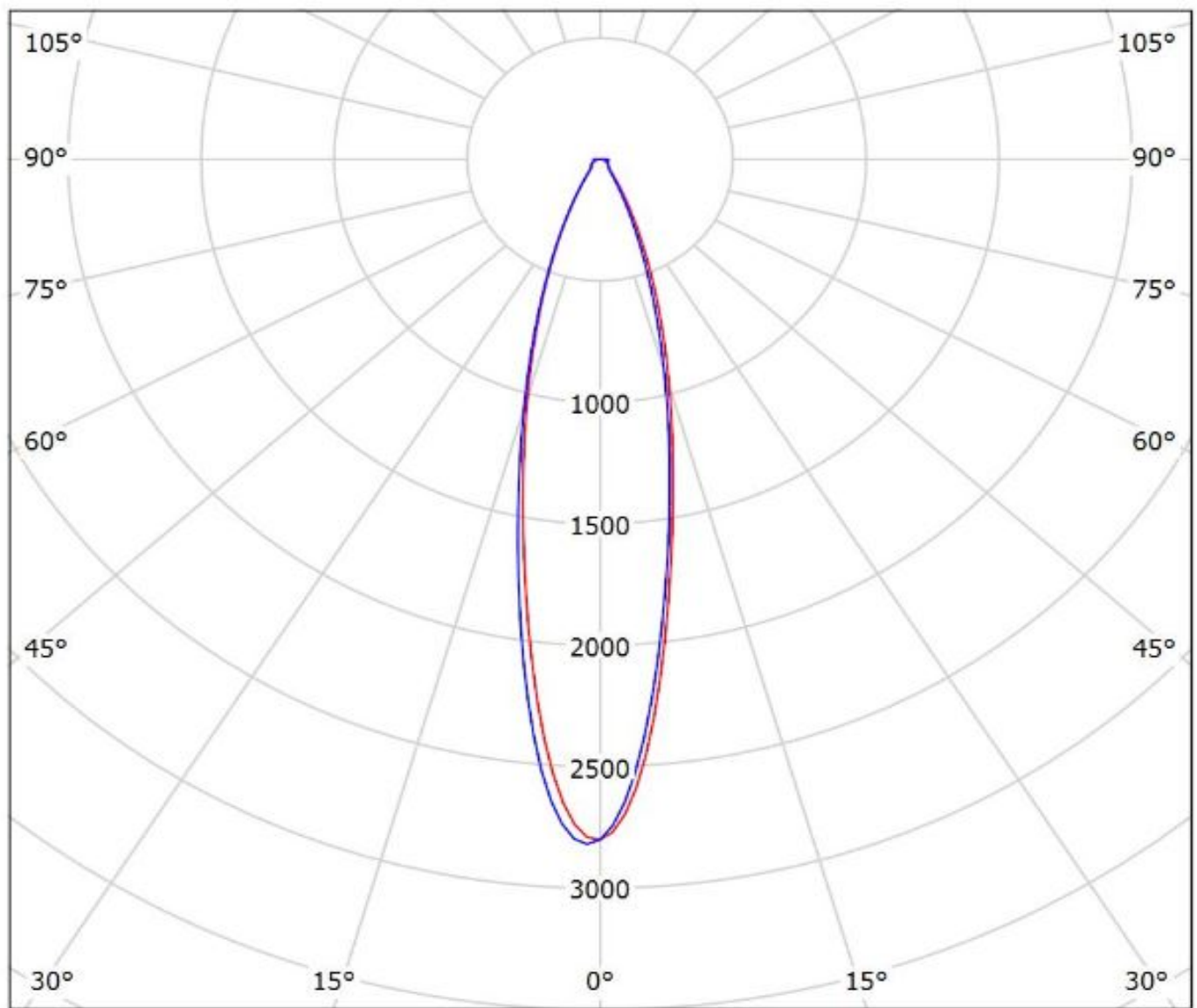

cd/klm

— C0 - C180 — C90 - C270

$\eta = 90\%$

Luminaire: Ledil F14486_FLORENCE_Z30_(DURIS_E5)

Lamps: 1 x Osram_DURIS_E5_584.018lm@120mA_P=3.69708W_I=120mA

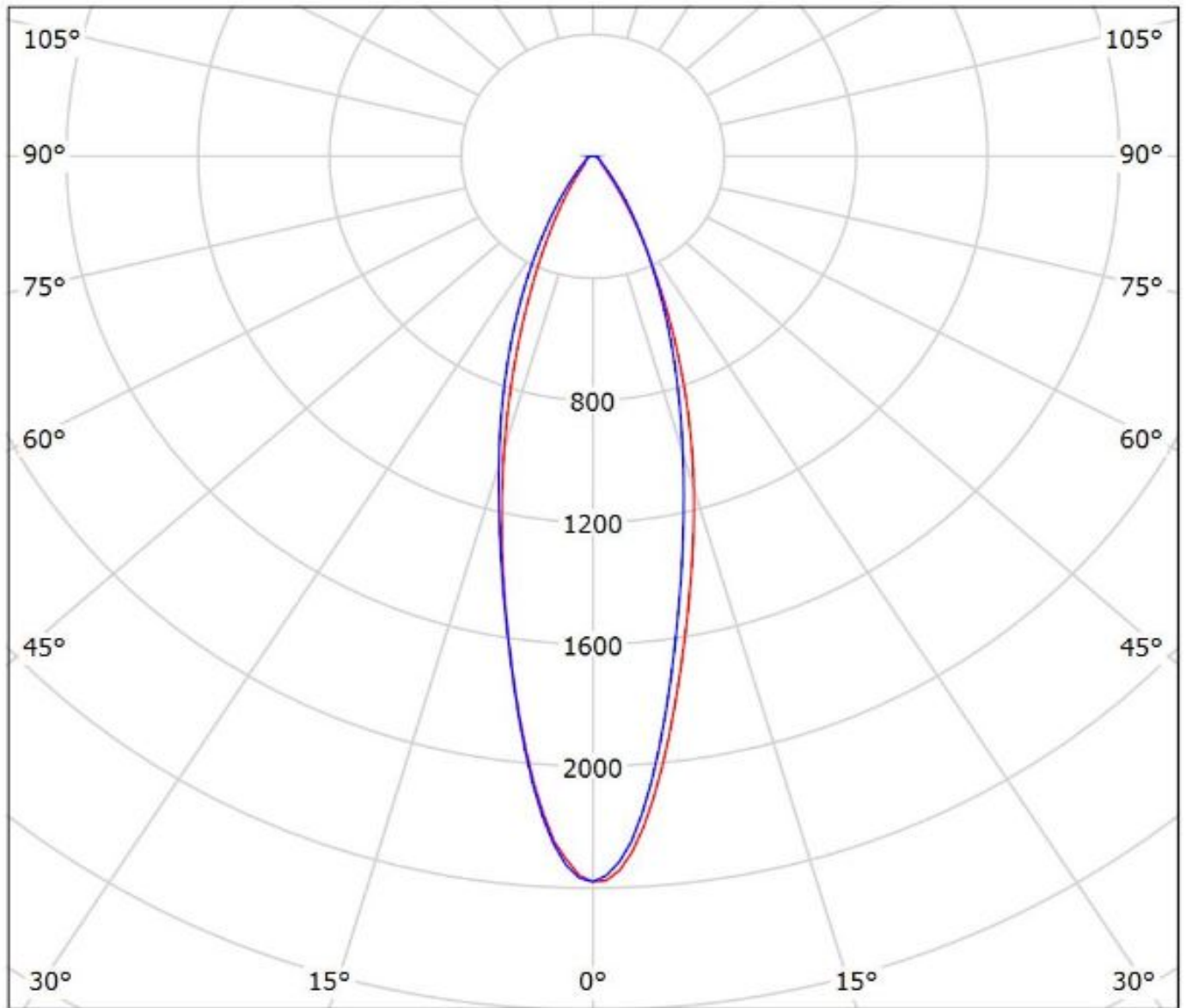

cd/klm

— C0 - C180

— C90 - C270

$\eta = 91\%$

Luminaire: Ledil Oy F14486_FLORENCE-Z30_(Duris_E_2835)_SIMULATED
Lamps: 1 x Osram Duris E 2835 - GW JTLRS1.EM

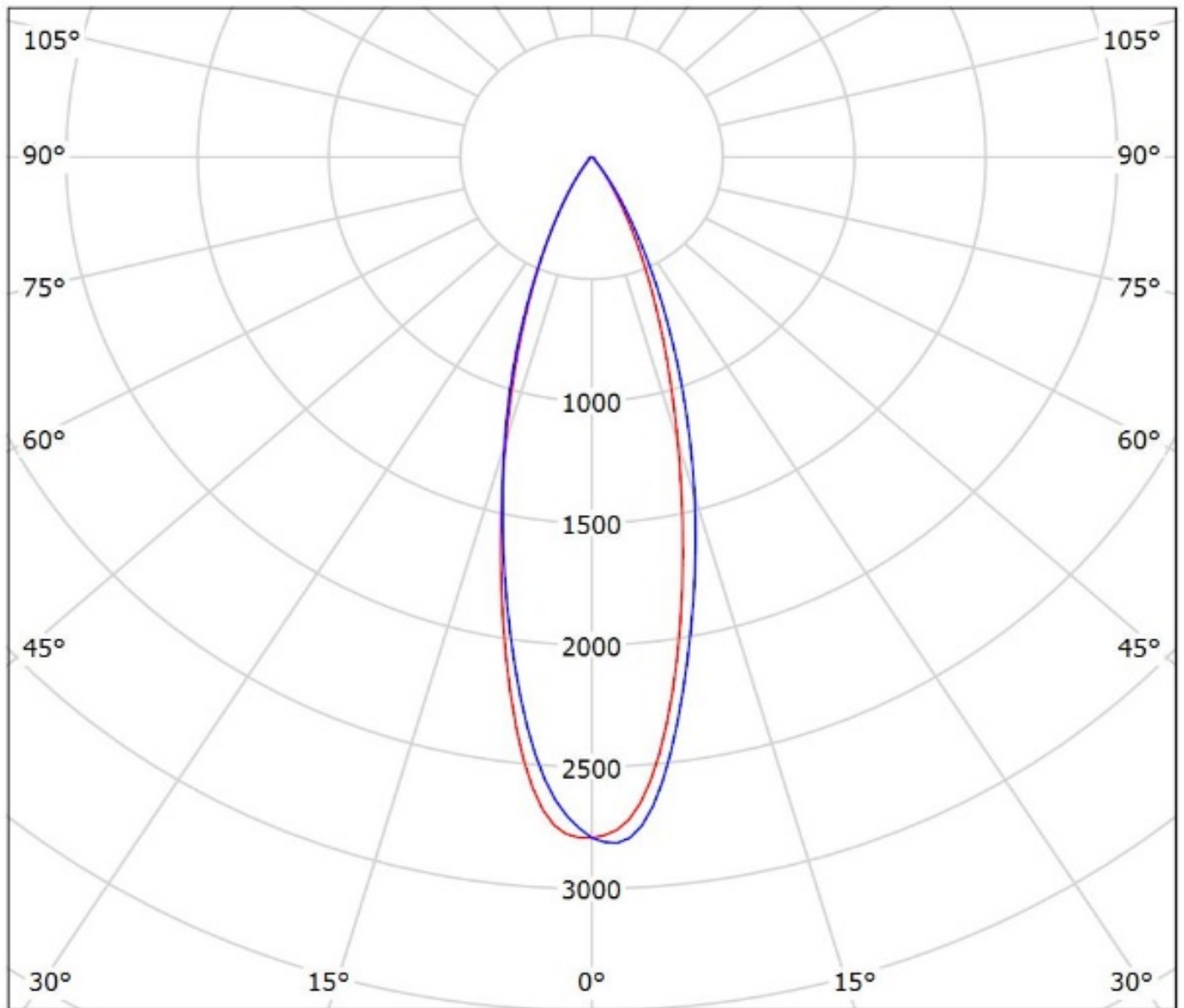

cd/klm

— C0 - C180 — C90 - C270

$\eta = 95\%$

Luminaire: LEDiL Oy F14486_FLORENCE-Z30

Lamps: 1 x (Fortimo 1ft 650lm 8x0 3R xV2 999.677lm@250mA_P=8.32933W_I=249.8mA)

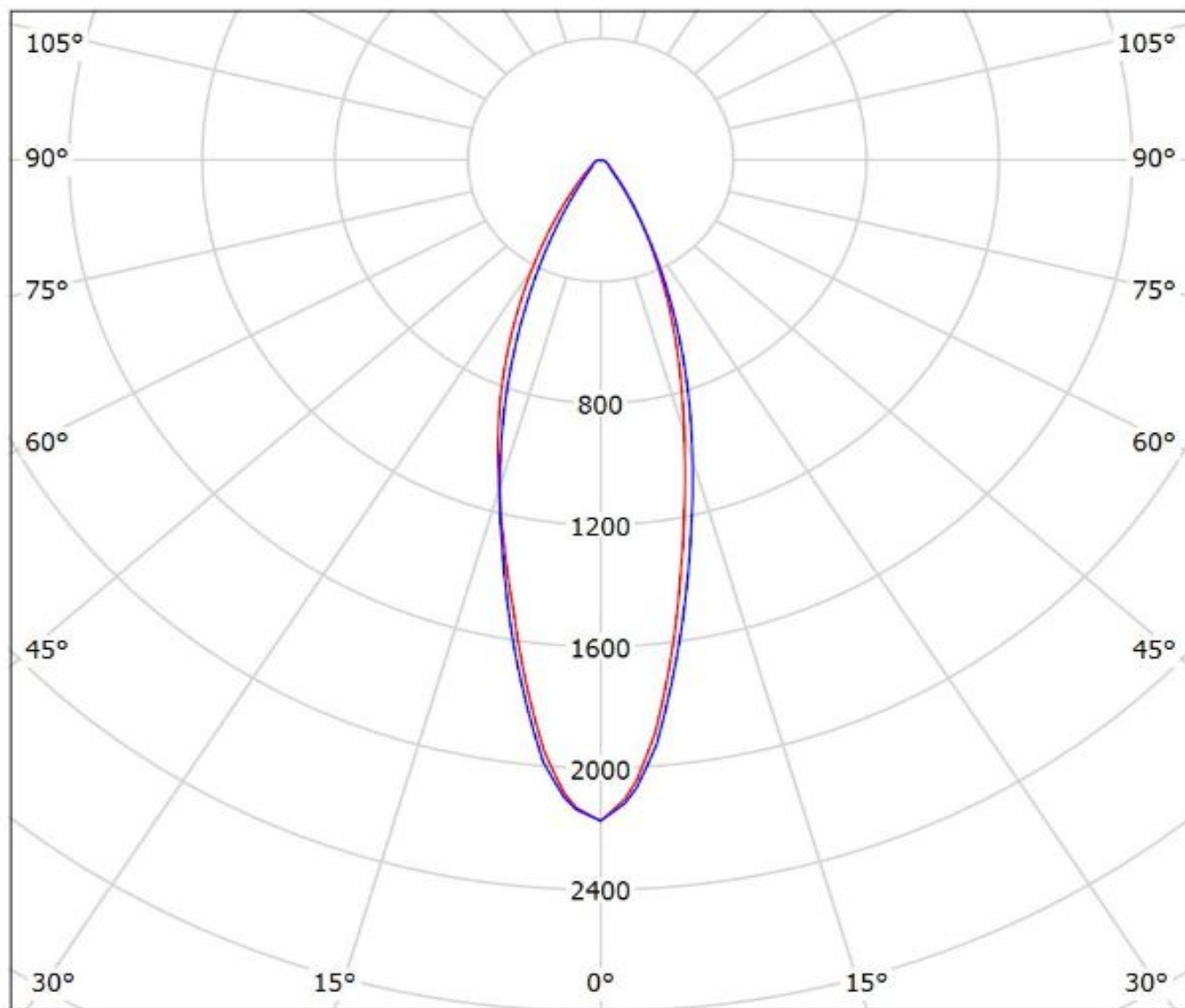

cd/klm

— C0 - C180 — C90 - C270

$\eta = 95\%$

Luminaire: Ledil F14486_FLORENCE-Z30_(Fortimo_LED_Line_3R_1100lm)
Lamps: 1 x Philips_fortimo_3R_1100lm_1080.96lm@250mA_P=7.8857W_I=0.25A

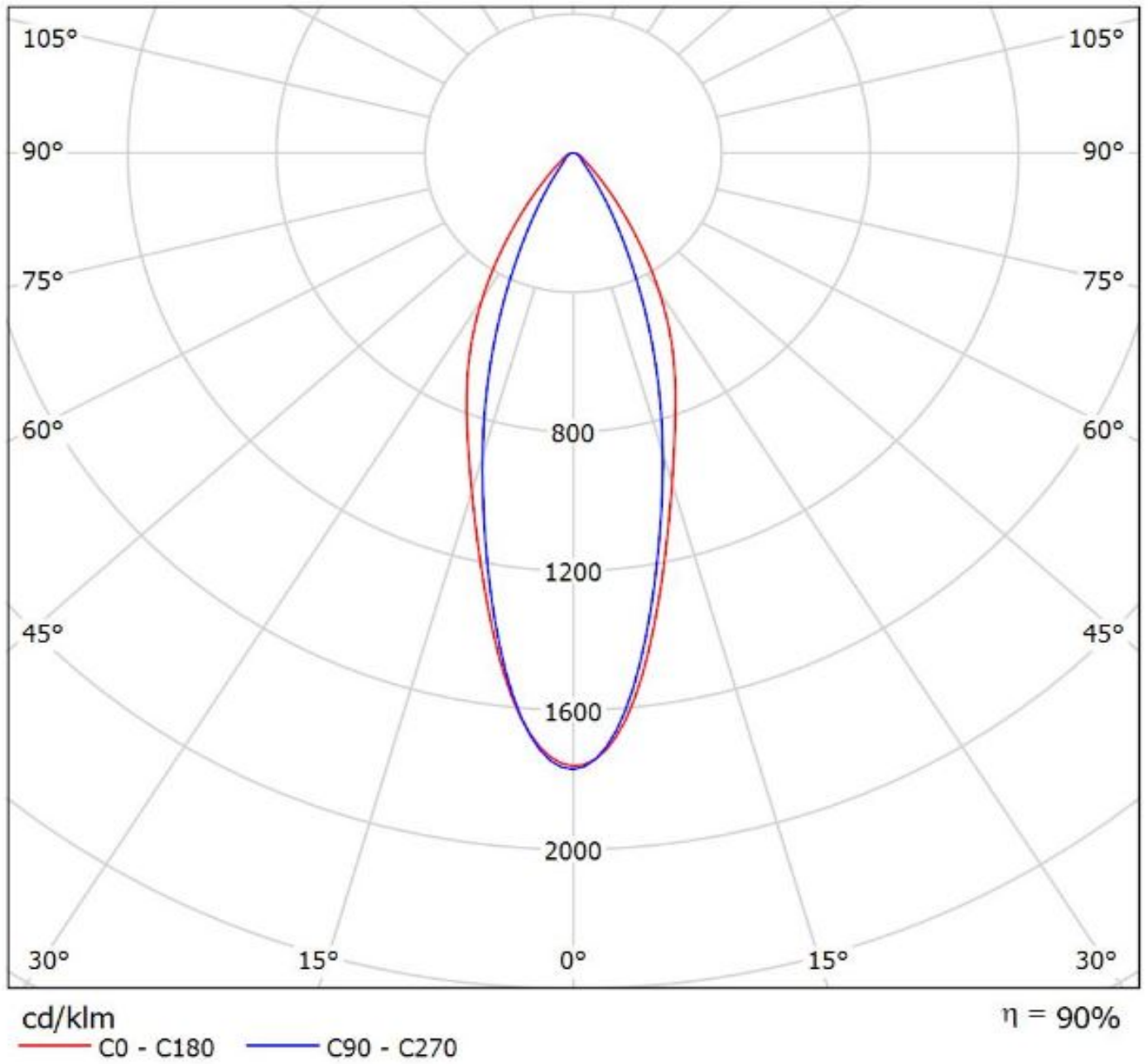

Luminaire: Ledil F14486_FLORENCE-Z30_(Fortimo_LED_Line_1ft_2000lm_8xx_3R_HV2)

Lamps: 1 x Fortimo_LED_Line_1ft_2000lm_8xx_3R_HV2_1229.9lm@250mA_CCT=3000K_P=7.5790W_I=0.25A

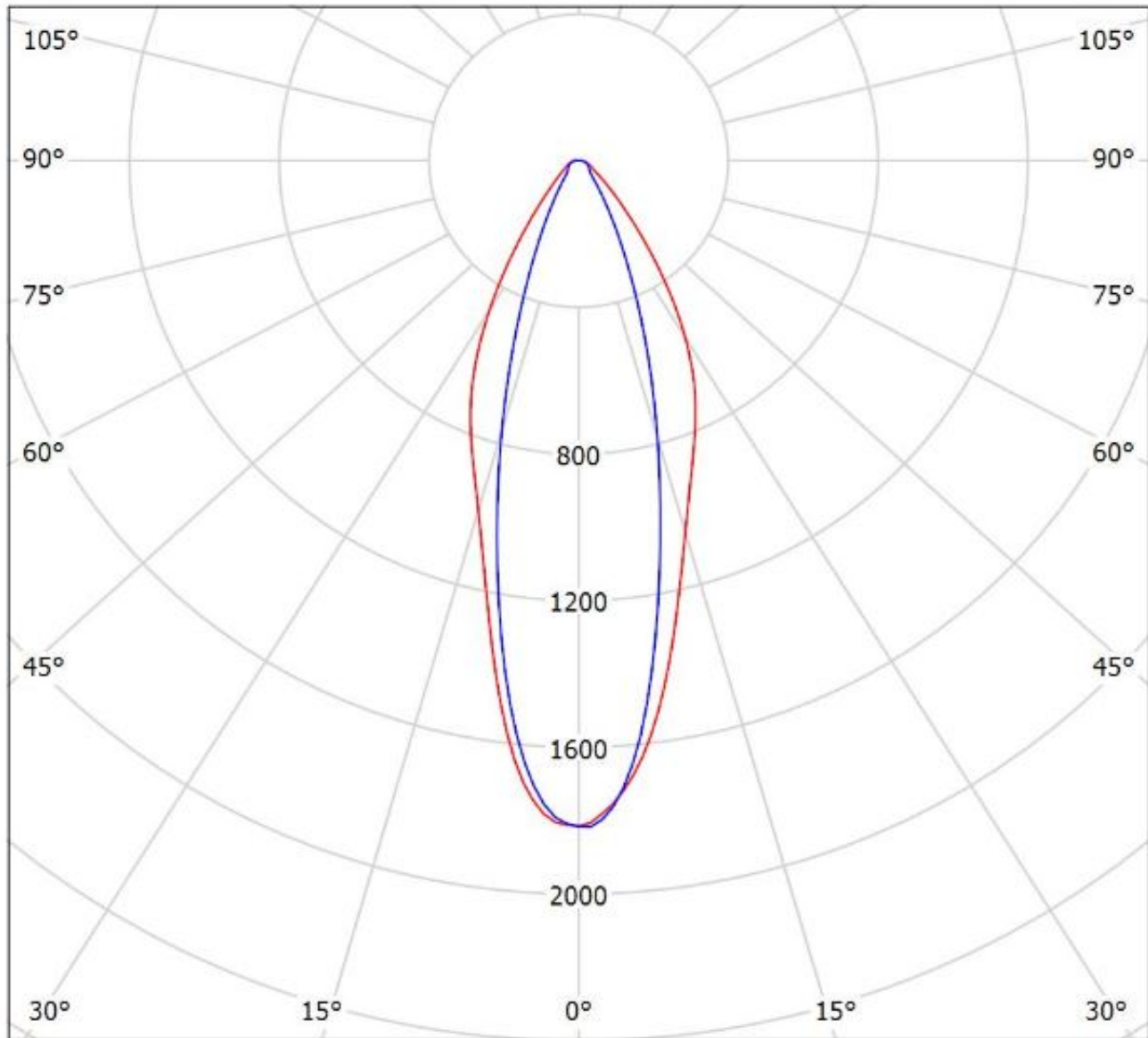

cd/klm

— C0 - C180 — C90 - C270

$\eta = 92\%$

Luminaire: LEDiL Oy F14486_FLORENCE-Z30_(LT-R286A)

Lamps: 1 x Samsung_LT-R286A_1304.7lm@250mA_P=8.2181W_I=0.250A

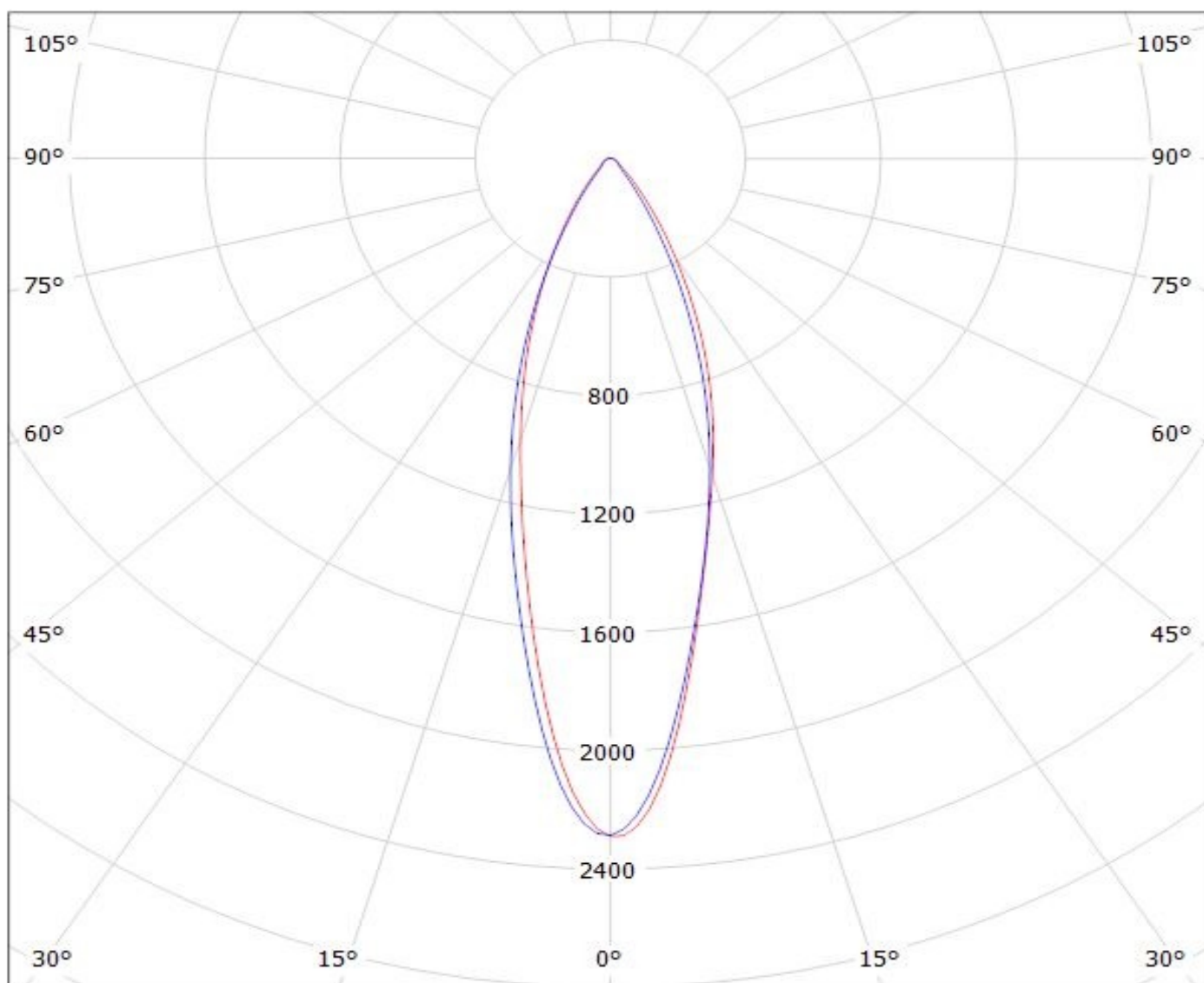

cd/klm

— C0 - C180

— C90 - C270

$\eta = 94\%$

Luminaire: Ledil F14486_FLORENCE-Z30_(LM561B)
Lamps: 1 x Samsung LM561B 1285.07lm@250mA_P=8.0415W_I=0.25A

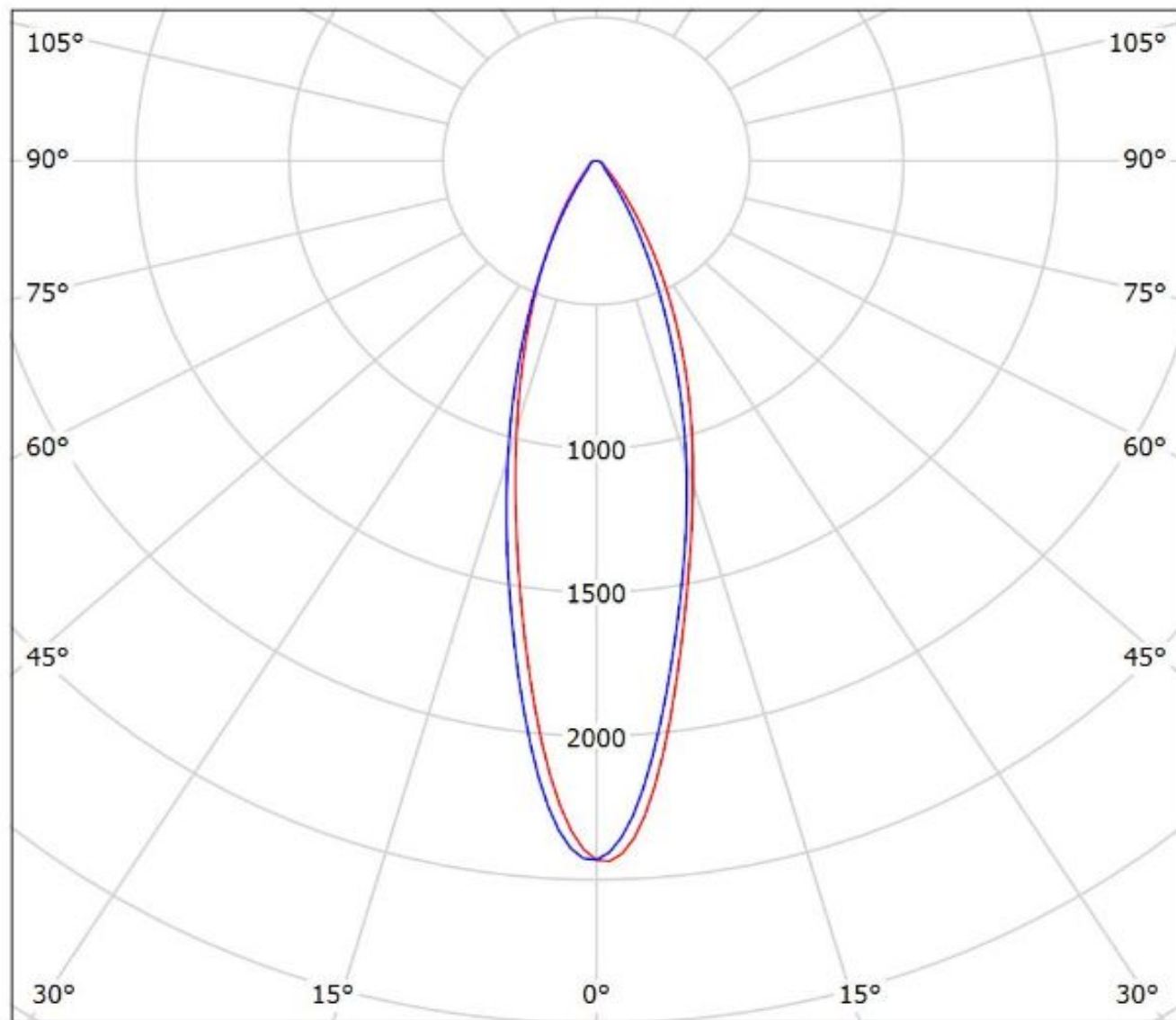

cd/klm
— C0 - C180 — C90 - C270

$\eta = 93\%$

Luminaire: Ledil F14486_FLORENCE-Z30_(LM561C)

Lamps: 1 x Samsung LM561C 1407.48lm@250mA_P=7.7190W_I=0.25A

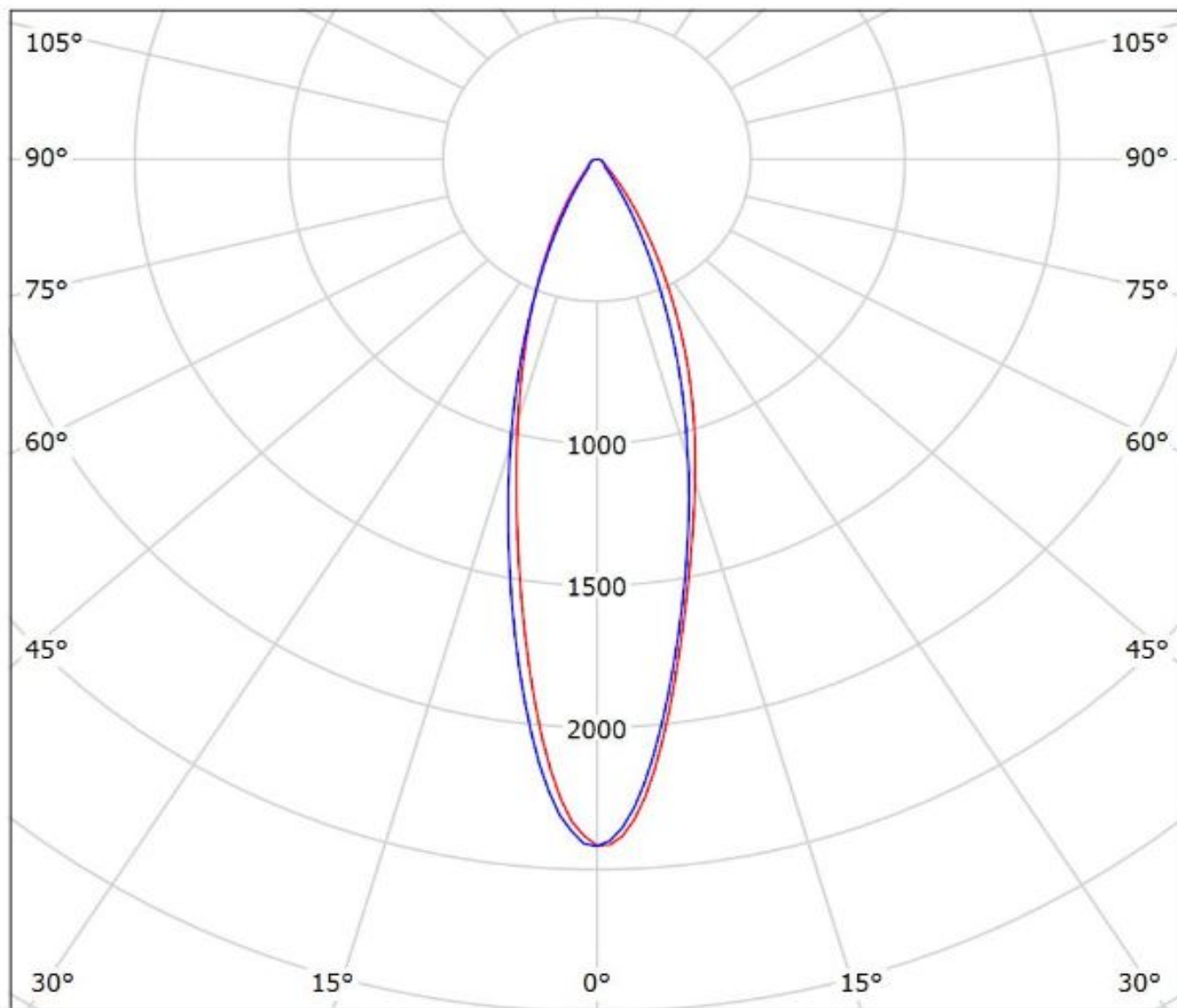

cd/klm

— C0 - C180 — C90 - C270

$\eta = 93\%$

Luminaire: Ledil F14486_FLORENCE-Z30_(LM561B PLUS)

Lamps: 1 x Samsung LM561B PLUS 1366.12lm@250mA_P=8.071W_I=0.25A

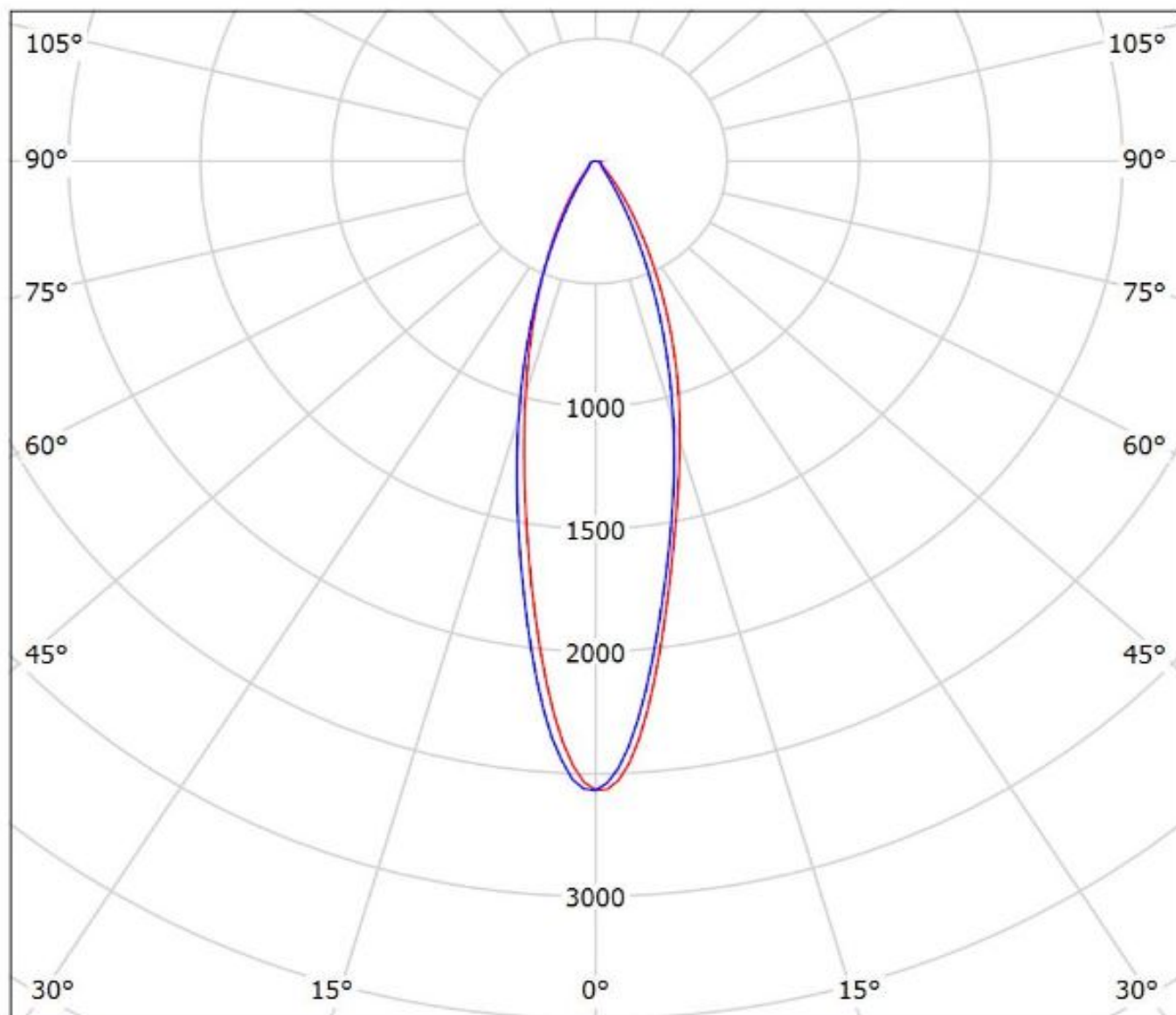

cd/klm

— C0 - C180 — C90 - C270

$\eta = 93\%$

Luminaire: Ledil Oy F14486_FLORENCE-Z30_SEOUL_5630_C_SIMULATED
Lamps: 1 x SEOUL 5630 C

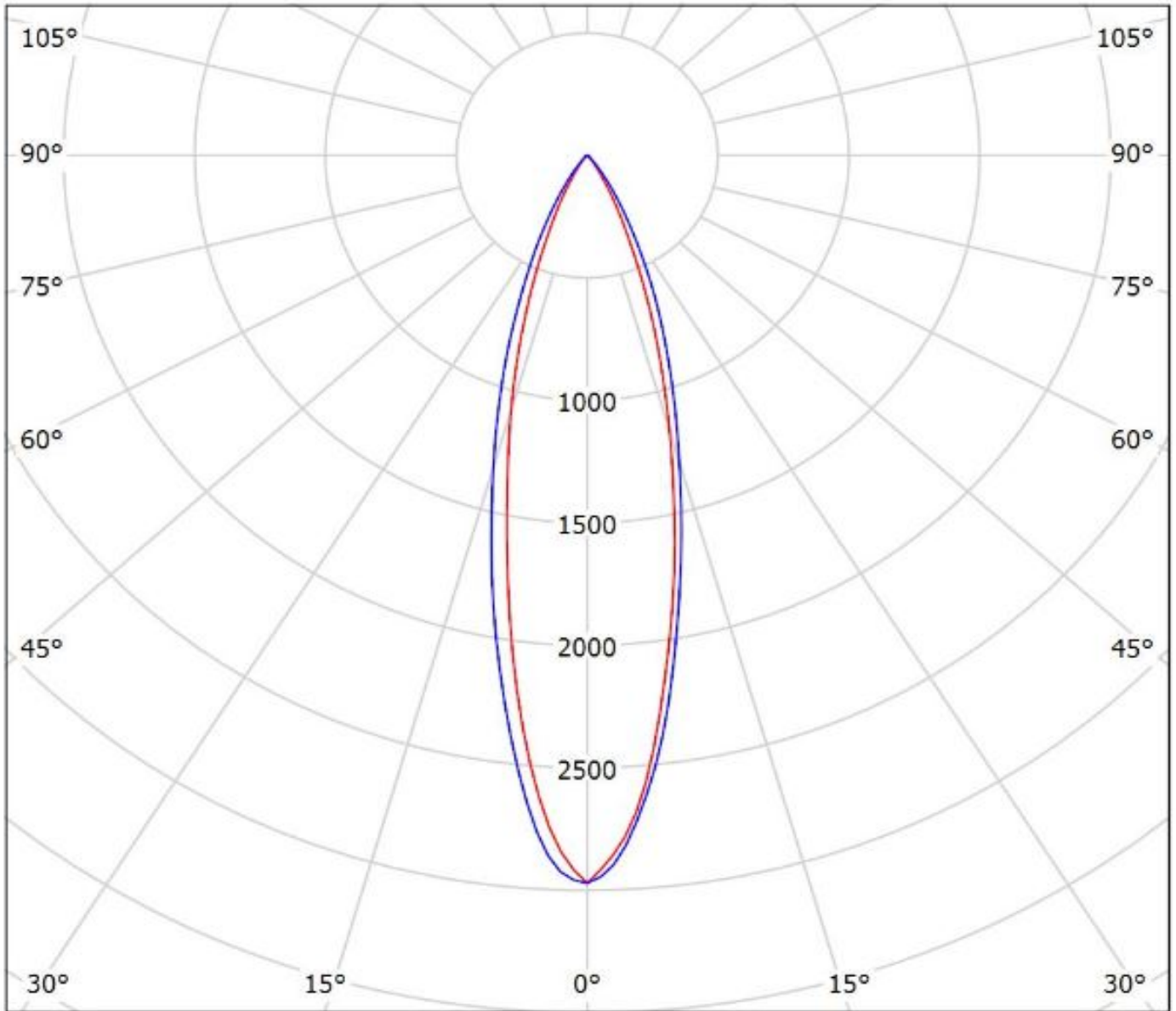

cd/klm

— C0 - C180 — C90 - C270

$\eta = 90\%$

Luminaire: Ledil Oy F14486_FLORENCE-Z30_SEOUL_5630_D_SIMULATED
Lamps: 1 x SEOUL 5630 D

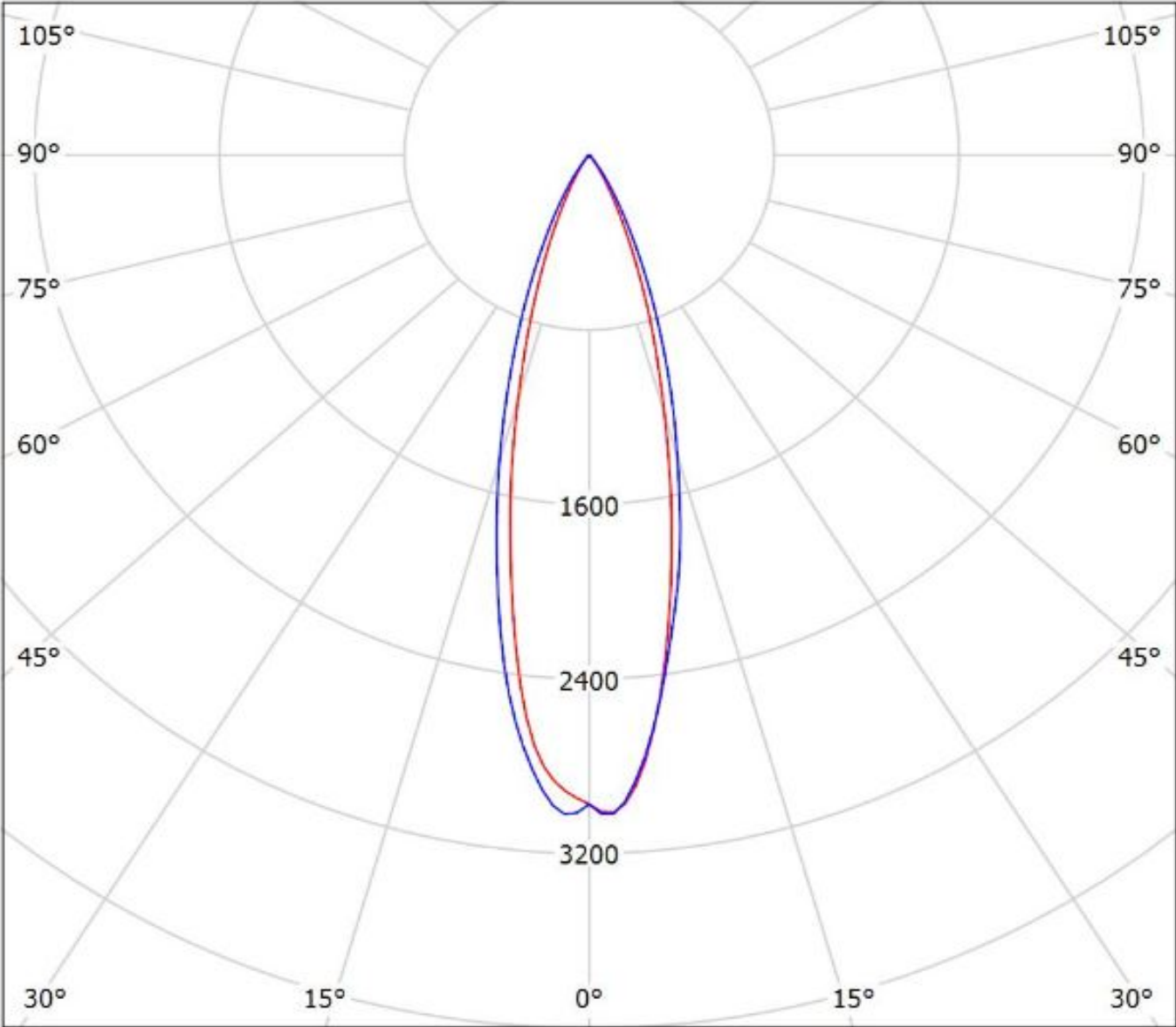

cd/klm
— C0 - C180 — C90 - C270

$\eta = 90\%$

Luminaire: LEDiL Oy F14486_FLORENCE-Z30_(LLE-55-280-1650)

Lamps: 1 x Tridonic_STARK_LLE-55-280-1650_(STARK_LLE-55-280-1650-840-CLA)_1478.34lm@325lm_CCT=4000K_P=10.1908W_I=324.9mA

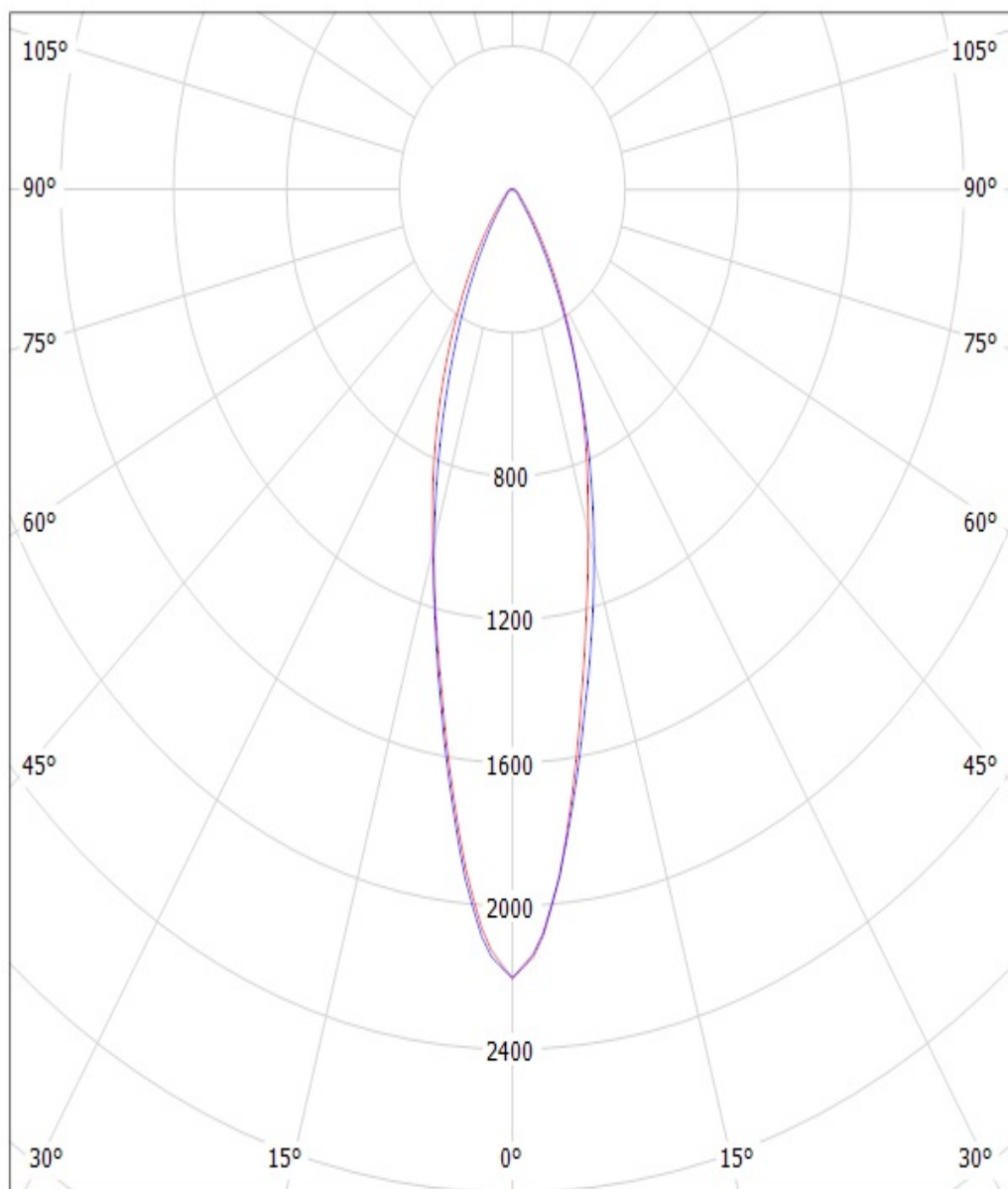

cd/klm

$\eta = 94\%$

— C0 - C180 — C90 - C270

NOTE: The typical divergence will be changed by different color, chip size and chip position tolerance. The typical total divergence is the full angle measured where the luminous intensity is half of the peak value.