

EAC-03-472 / ESC-03-472

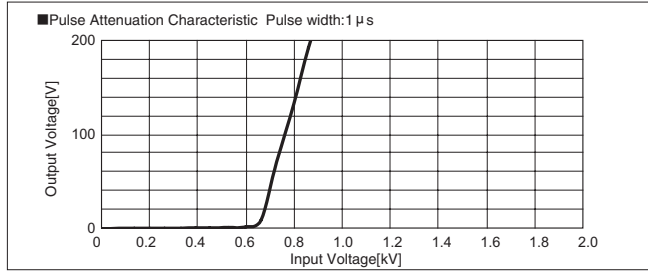

EAC-06-472 / ESC-06-472

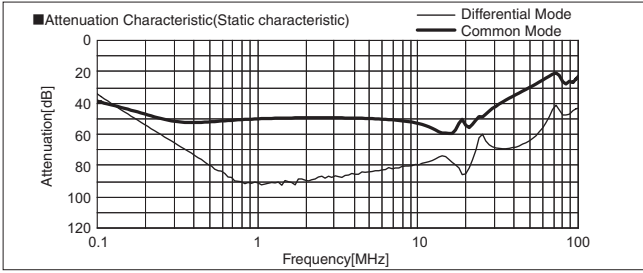
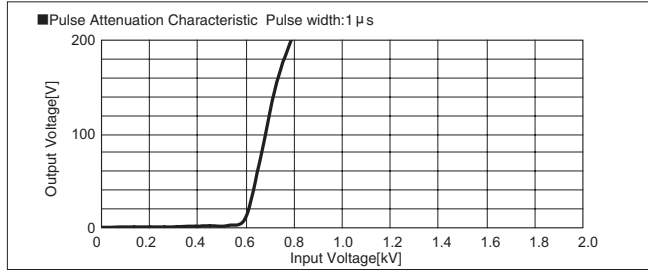
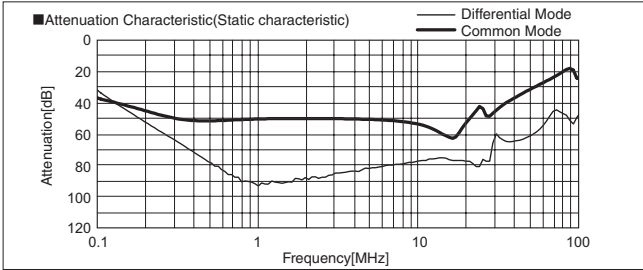

EAC-10-472 / ESC-10-472

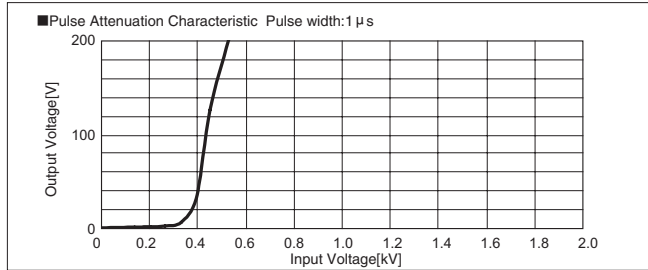
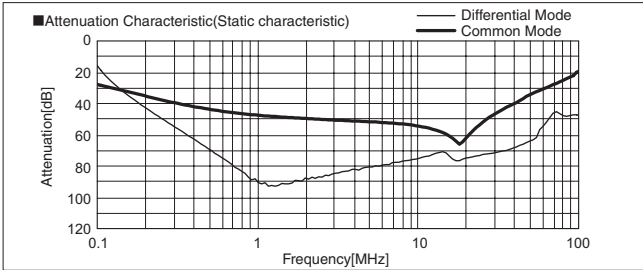

EAC-16-472 / ESC-16-472

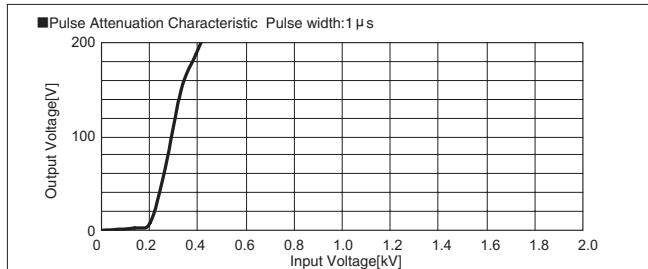
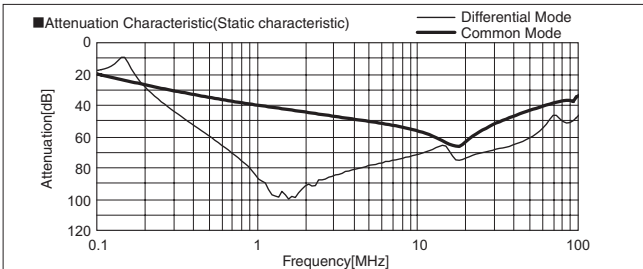

EAC-20-472

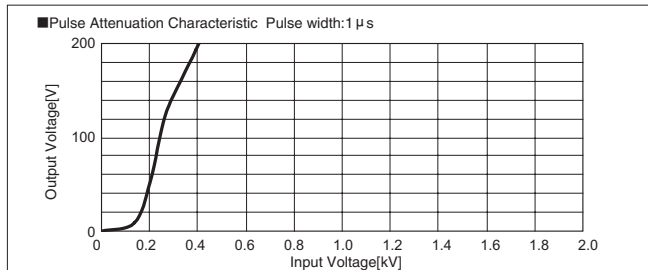
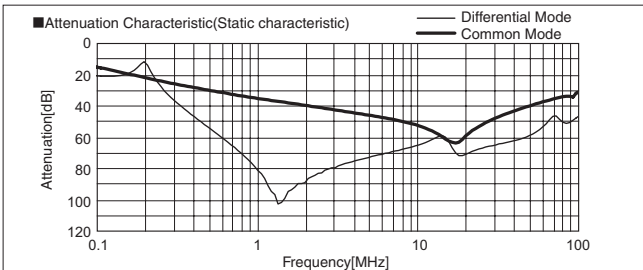

EAC-30-472

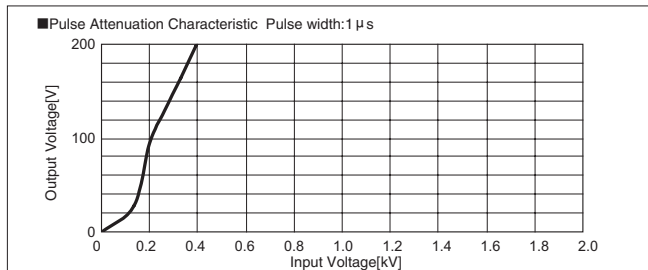
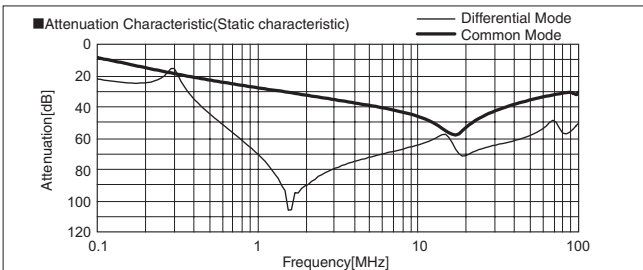

1 Applicable Electric Cable

- Only use the electric cable that exists in the Table1.
- Use the cable that conductor material is copper. Do not use the cable that conductor material is iron or aluminum. Never use the one other than the electric cable.
Ex. Steel wire, Stick made of resin, other wire
- Note that the current rating is different in each electric cable.
- Strip so as not to damage the conductor at stripping sheath.
- Strip specified length of cable sheath (Refer to Table1).
Strip Length can be confirmed with a gauge of the body case. Refer to External view.
- Do not put solder on the conductor. It becomes impossible to connect cable.

Table.1 Applicable Wire

Solid wire	Diameter 0.5mm to 1.2mm (AWG.22 to AWG.16)
Stranded wire	0.3mm ² to 1.25mm ² (AWG.22 to AWG.16) Conductor diameter more than 0.18 mm
Sheath strip length	10mm to 12mm

2 Applicable bar-type terminal

- The applicable bar-type terminal (Refer to Table 2) must be used, and after crimp, the size of bar-type terminal must be kept value of Table 3. Use the applicable terminal (Refer to Table 2) and keep the size of terminal, or you will not be able to connect cable. Contact us when the bar-type terminals other than the applicable bar-type terminal (Refer to Table 2) are used.
- Connect cable so as not to conceal the button with the sleeve of the cable when a round terminals other than the applicable terminal are used.

Table.2 Applicable bar-type terminal

Manufacturer	Size	model	Crimp tool
Phoenix Contact	AWG.22	AI0.34-12TQ	CRIMPFOX UD6-4
	AWG.20	AI0.5-10WH AI0.5-12WH	
	AWG.18	AI0.75-10GY AI0.75-12GY AI1-10RD AI1-12RD	
	AWG.16	AI1.5-10BK AI1.5-12BK	
Nichifu	AWG.22-16	TGN TC-1.25-11T TGV TC-1.25-11T	NH11 NH32 NH65

<Square type>

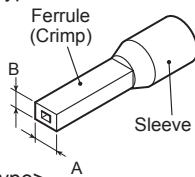

<Round type>

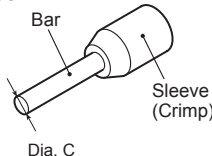
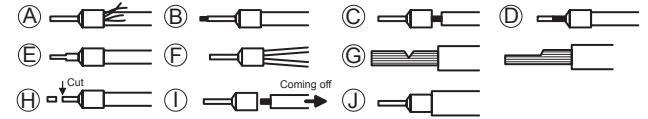

Table.3 Dimension of terminal at crimp
[Dimensions in mm]

Part	Dimension
A	1.1 to 2.6
B	0.8 to 1.6
Dia. C	0.8 to 1.6

3 State of crimped bar-type terminal

● Bad condition



- Ⓐ The wire protrudes from the sleeve.
- Ⓑ The conductor extremely protrudes from the point of the bar-type terminal.
- Ⓒ The electric conductor is not inserted enough and the conductor has been exposed from the terminal.
- Ⓓ The sheath strip length doesn't suffice and the conductor is not enough inserted in the ferrules.
- Ⓔ Crimp is only the point of conductor.
- Ⓕ It crimps two electric cables.
- Ⓖ There is a damage or a disconnection part in the conductor.
- Ⓗ The point of the terminal is cut.
- Ⓘ It comes off the terminal when the cable is pulled.
- ⓵ The sheath of the cable protrudes from the sleeve.

4 Wiring Terminal Blocks (connecting/releasing)

- One electric cable one insertion hole. When two or more is connected, it causes trouble.
- Do connecting and releasing of the electric cable by using a flat-blade driver while pushing the connection/release button. Moreover, insert the conductor or the bar-type terminal to the end fully.
- When you connect the stranded cable, connect wires after lightly stranding wires.
- Confirm the electric cable is surely connected with the terminal after connecting.
- The check hole can be used for the check of wire connecting and insulation and for the operation monitor etc.

● Connecting : Stranded cable, Solid cable (Diameter 0.5 to 0.9)

- StepI Push the button with a flat-blade driver.
- StepII Insert the cable into the hole while pushing the button.
- StepIII Release the flat-blade driver and cable connection is completion.

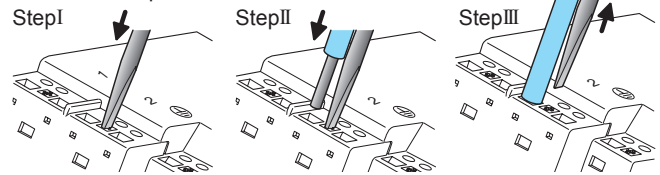

● Connecting : Solid wire (except diameter 0.5 to 0.9), bar type terminal

- Insert the cable into the insertion hole.
* Insert it while pushing the button when it is not easy to insert it.

● Releasing : Stranded wire, Solid wire, bar type terminal

- Pull out the electric cable while pushing the button with flat-blade driver.
* Notice : Two insertion holes are released at the same time by pushing the button once. (Except PE terminal)

- Use the flat-blade driver that meets the size in Table 4.

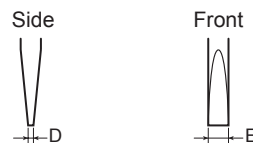
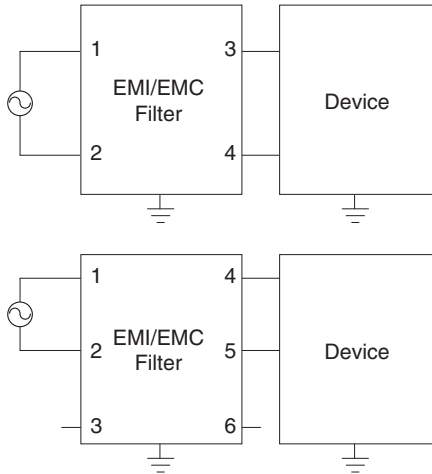

Table.4 Dimension of flat-blade driver
[Dimensions in mm]

Part	Dimension
D	1.0max
E	3.0max

1 Method of connecting EMI/EMC Filter

(1) Single Phase



※Three phase EMI/EMC filter is also available as a single phase input type.

(2) Three phase (Delta-connection)

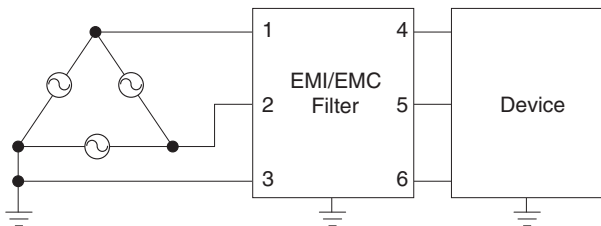

(3) Three phase (Star-connection)

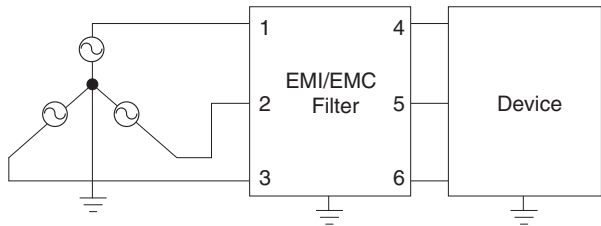

[Reference] Example of calculating input current calculation

Input voltage 400 [V]

Input capacity of the equipment 4000 [VA]

$$\text{Input current} = \frac{4000 \text{ [VA]}}{400 \text{ [V]} \times \sqrt{3}} = 5.8 \text{ [A]}$$

2 Caution when connecting EMI/EMC Filter

Please note the excessive temperature increase of EMI/EMC filter. Please contact us if judgement is difficult.

(1) Input voltage and frequency

Please use within the rated voltage (or maximum voltage) of each model.

Input frequency specification for AC input EMI/EMC filter is considered as commercial frequency (50/60Hz).

It should not be used under the following conditions.

- 1) Distorted input voltage waveform.
(Triangle wave, square wave etc.)
- 2) High input frequency (ex: 400Hz)

(2) Input current

Please use within the rated current of each model.

EMI/EMC filters have short term peak current capability. Therefore, it can flow ~40A or ten times of rated current, non-repeated, within a few ms such as inrush current of power supply etc.

However, it should not be used under the following conditions.

- 1) Long duration peak current.
- 2) Peak current or high-frequency current is continuously flowing.

(3) Connection to a general-purpose inverter (servo driver)

Please connect EMI/EMC filter to input side of inverter driver (servo driver).

It should not be used between the inverter (servo driver) and the motor.

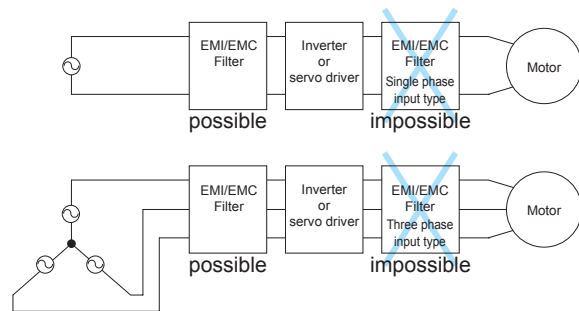

3 Safety Considerations

- To apply for safety standard approval using this EMI/EMC Filter, the following conditions must be met.
- The unit must be used as a component of an end-use equipment.
- Protection earth terminal (PE) must be connected to safety ground of end-use equipment.

(1) Attenuation Characteristic(Static characteristic)

※ Attenuation= $20\log(U_{b1}/U_{b2})$ (dB)
 U_{b1} : Voltage in state without filters
 U_{b2} : Voltage in state which added filters
 ※ N.A.: Network analyzer

■ Object product : Single phase input type (Differential mode)

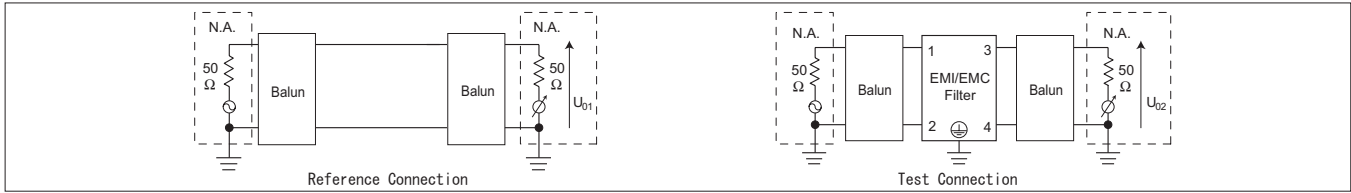

■ Object product : Single phase input type (Common mode)

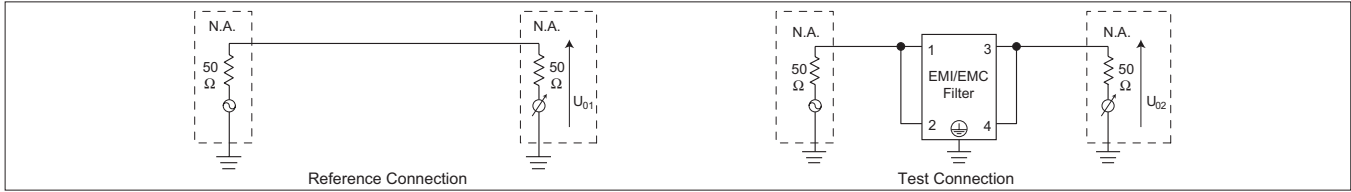

■ Object product : Three phase input type (Differential mode)

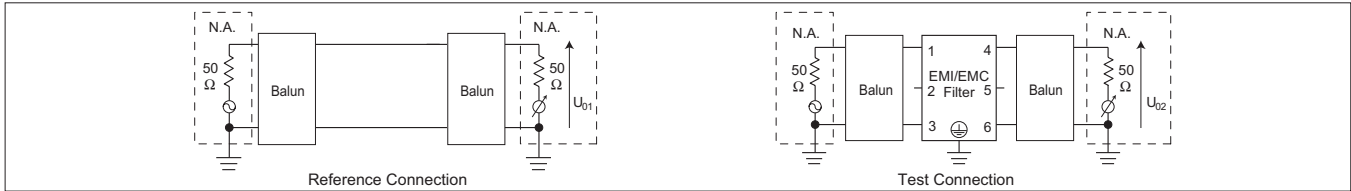

■ Object product : Three phase input type (Common mode)

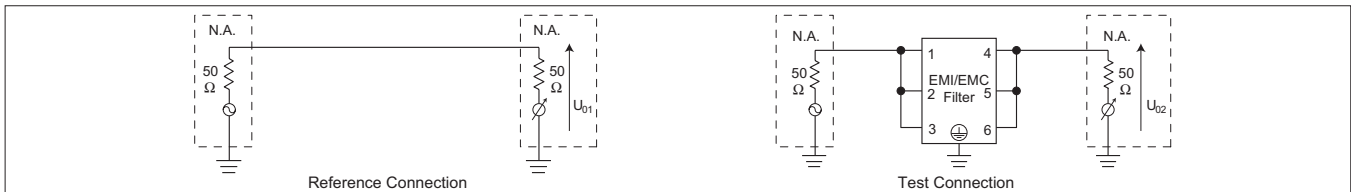

■ Object product : DC input type (Differential mode)

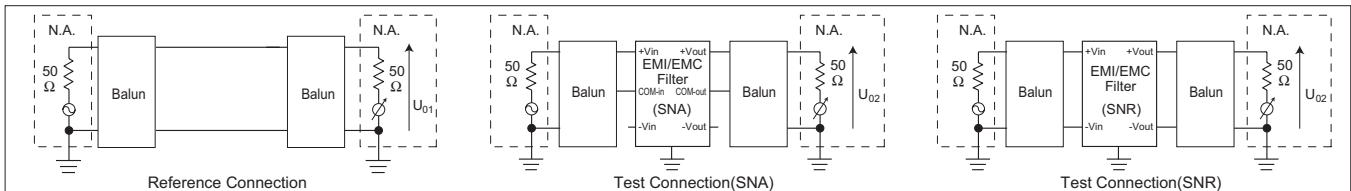

■ Object product : DC input type (Common mode)

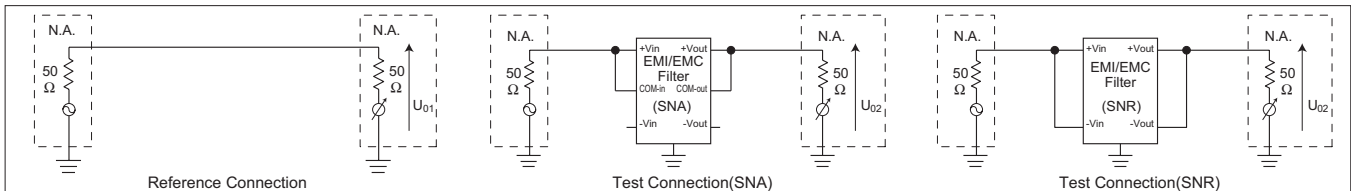

(2) Pulse Attenuation Characteristic

