

Flush-type connector - SACC-E-M12FS-5CON-M16/1,5 - 1576669

Please be informed that the data shown in this PDF Document is generated from our Online Catalog. Please find the complete data in the user's documentation. Our General Terms of Use for Downloads are valid (<http://phoenixcontact.com/download>)



Sensor/Actuator flush-type socket, 5-pos., M12, A-coded, front/screw mounting with M16 thread, with 1.5 m TPE litz wire, 5 x 0.34 mm²



Key Commercial Data

Packing unit	1 pc
Minimum order quantity	50 pc
GTIN	 4 0 4 6 3 5 6 4 4 8 1 7 8
GTIN	4046356448178

Technical data

Dimensions

Fixed cable length	1.5
--------------------	-----

Ambient conditions

Ambient temperature (operation)	-25 ... -85 (cable, fixed installation)
---------------------------------	---

General

Standards/regulations	according to IEC 61076-2-101
Overvoltage category	II
Mounting type	Front wall/screw mounting
Coding	A-coded
Thread type	M16 x 1.5
Cable cross section	0.34
AWG signal line	22
Rated surge voltage	1.5 kV AC
Degree of pollution	3
Degree of protection	IP67
Number of positions	5

Flush-type connector - SACC-E-M12FS-5CON-M16/1,5 - 1576669

Technical data

General

Current	4 A
Voltage	60 V
Degree of protection	IP67

Material

Contact material	CuZn
Contact surface material	Au
Cable gland material	Zinc die-cast, nickel-plated

Connection data

Connection method	Individual wires
Contact resistance with connected conductor	≤ 3 mΩ
Cable type	TPE litz wire

Standards and Regulations

Standards/specifications	according to IEC 61076-2-101
Flammability rating according to UL 94	V0
Safety note	WARNING: The connectors may not be plugged in or disconnected under load. Ignoring the warning or improper use may damage persons and/or property.
	<ul style="list-style-type: none"> • WARNING: Commission properly functioning products only. The products must be regularly inspected for damage. Decommission defective products immediately. Replace damaged products. Repairs are not possible.
	<ul style="list-style-type: none"> • WARNING: Only electrically qualified personnel may install and operate the product. They must observe the following safety notes. The qualified personnel must be familiar with the basics of electrical engineering. They must be able to recognize and prevent danger. The relevant symbol on the packaging indicates that only personnel familiar with electrical engineering are allowed to install and operate the product.
	<ul style="list-style-type: none"> • The products are suitable for applications in plant, controller, and electrical device engineering.
	<ul style="list-style-type: none"> • When operating the connectors in outdoor applications, they must be separately protected against environmental influences.
	<ul style="list-style-type: none"> • Assembled products may not be manipulated or improperly opened.
	<ul style="list-style-type: none"> • Only use mating connectors that are specified in the technical data of the standards listed (e.g. the ones listed in the product accessories online at phoenixcontact.com/products).
	<ul style="list-style-type: none"> • When using the product in direct connection with third-party manufacturers, the user is responsible.
	<ul style="list-style-type: none"> • For operating voltages > 50 V AC, conductive connector housings must be grounded
	<ul style="list-style-type: none"> • Ensure that when laying the cable, the tensile load on the connectors does not exceed the upper limit specified in the standards.
	<ul style="list-style-type: none"> • Observe the corresponding technical data. You will find information: <ul style="list-style-type: none"> o On the product o On the packing label o In the supplied documentation o Online at phoenixcontact.com/products under the product

Flush-type connector - SACC-E-M12FS-5CON-M16/1,5 - 1576669

Technical data

Standards and Regulations

	<ul style="list-style-type: none"> • Only use tools recommended by Phoenix Contact
	<ul style="list-style-type: none"> • Use a protective cap to protect connectors that are not in use. The suitable accessories are available online in the accessory section of the product at phoenixcontact.com/products
	<ul style="list-style-type: none"> • Ensure that the protective or functional ground has been properly connected.
	<ul style="list-style-type: none"> • VDE 0100/1.97 § 411.1.3.2 and DIN EN 60 204/11.98 § 14.1.3 are applicable when combining several circuits in a cable and/or connector
	<ul style="list-style-type: none"> • The connector warms up in normal operation. Depending on the ambient conditions, the surface of the connector can continue to warm up. In this case, the user is responsible for posting warnings (e.g. DIN EN ISO 13732-1:2008-12).
Standards/specifications	according to IEC 61076-2-101

Environmental Product Compliance

China RoHS	Environmentally friendly use period: unlimited = EFUP-e
	No hazardous substances above threshold values

Drawings

Dimensional drawing

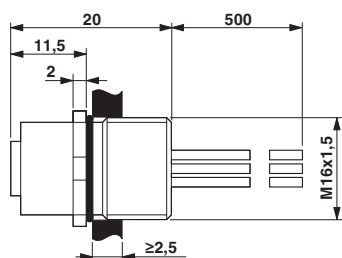

M12 flush-type connector

Circuit diagram



Contact assignment of the M12 plug and the M12 socket

Flush-type connector - SACC-E-M12FS-5CON-M16/1,5 - 1576669

Dimensional drawing

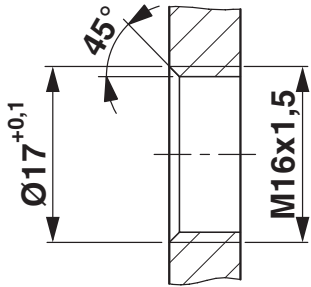

Housing cutout for M16 fastening thread, mounting panel with thread

Dimensional drawing

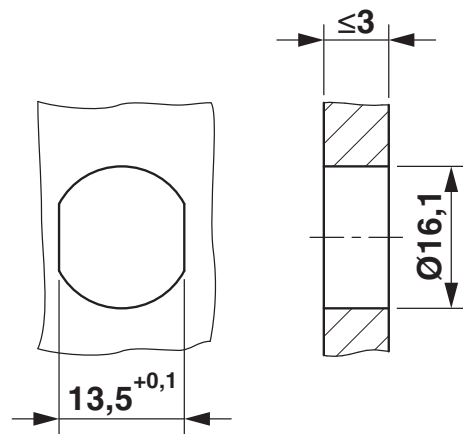

Housing cutout for M16 fastening thread, mounting panel with feed-through hole (alternatively with surface as protection against rotation)

Schematic diagram

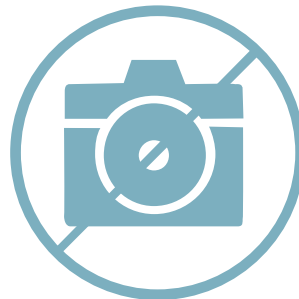

Pin assignment M12 socket, 5-pos., A-coded, socket side view

Classifications

eCl@ss

eCl@ss 10.0.1	27440102
eCl@ss 11.0	27440102
eCl@ss 4.0	27140800
eCl@ss 4.1	27140800
eCl@ss 5.0	27143400
eCl@ss 5.1	27143400
eCl@ss 6.0	27279200
eCl@ss 7.0	27440103
eCl@ss 9.0	27440102

ETIM

ETIM 3.0	EC002061
ETIM 4.0	EC002061

Flush-type connector - SACC-E-M12FS-5CON-M16/1,5 - 1576669

Classifications

ETIM

ETIM 6.0	EC002061
ETIM 7.0	EC002635

UNSPSC

UNSPSC 6.01	31251501
UNSPSC 7.0901	31251501
UNSPSC 11	31251501
UNSPSC 12.01	31251501
UNSPSC 13.2	39121413
UNSPSC 18.0	39121413
UNSPSC 19.0	39121413
UNSPSC 20.0	39121413
UNSPSC 21.0	39121413

Approvals

Approvals

Approvals

UL Recognized / EAC

Ex Approvals

Approval details

UL Recognized		http://database.ul.com/cgi-bin/XYV/template/LISEXT/1FRAME/index.htm	FILE E 118976
Nominal voltage UN	60 V		
Nominal current IN	4 A		
mm ² /AWG/kcmil	22		

EAC		B.01687
-----	---	---------

Accessories

Accessories

Flat nut

Flush-type connector - SACC-E-M12FS-5CON-M16/1,5 - 1576669

Accessories

Flat nut - SACC-E-MU-M16 - 1504097



Flat nut with M16 thread

Phoenix Contact 2021 © - all rights reserved
<http://www.phoenixcontact.com>

PHOENIX CONTACT GmbH & Co. KG
Flachsmarktstr. 8
32825 Blomberg
Germany
Tel. +49 5235 300
Fax +49 5235 3 41200
<http://www.phoenixcontact.com>