

DISK # DWG SIZE DATA CONTAINED IN THIS DOCUMENT IS PROPRIETARY TO TROMPETER ELECTRONICS INC. AND SHALL NOT BE DISCLOSED, COPIED OR USED FOR PROCUREMENT OR MANUFACTURE WITHOUT EXPRESS WRITTEN PERMISSION.

K 1 C

REVISIONS			310-0067	SH 1	
REV	EO	DESCRIPTION	DWN	APPROVED	DATE
F	10054	PICTORIALLY CHANGED 1.00 FLARED SEALING SLEEVE TO STRAIGHT (1.25) LONG SEALING SLEEVE; GENERAL UPDATE	DKC	<i>DKC</i>	12/13/92

DASH NO	MODEL NO	CENTER CONTACT/INTMD CONTACT TYPE
-1	PL3455AC P	SOCKET/PIN
-2	PL3455AC S	PIN/SOCKET

CABLE GROUP NO	CABLES ACCOMMODATED	ASSEMBLE PER	
-201	M17/176-00002	TAI-162	
-202	TWC-78-1, TROMPETER		
-203	TWC-124-1A, TROMPETER		
-204	10602, RAYCHEM		
-205	TWAC-78-1F2, TROMPETER		
-206	782600130, RAYCHEM		
-208	202-3927, MICRODOT		
-209	202-3942, MICRODOT		
-212	2524E0114, RAYCHEM		
-217	GC875TM24H GRUMMAN		
-218	EPD22188B, RAYCHEM		
-219	2526D1114, RAYCHEM		
-220	GC875RR1, GRUMMAN		
-221	10614, RAYCHEM		
-222	10613, RAYCHEM		
-223	HMS2-1149, HUGHES		
-303	7528A5314, RAYCHEM		TAI-190

INCH	MM
.002	0.05
.005	0.13
.030	0.76
.045	1.14
.255	6.48
.450	11.43
1.25	31.75
1.45	36.83

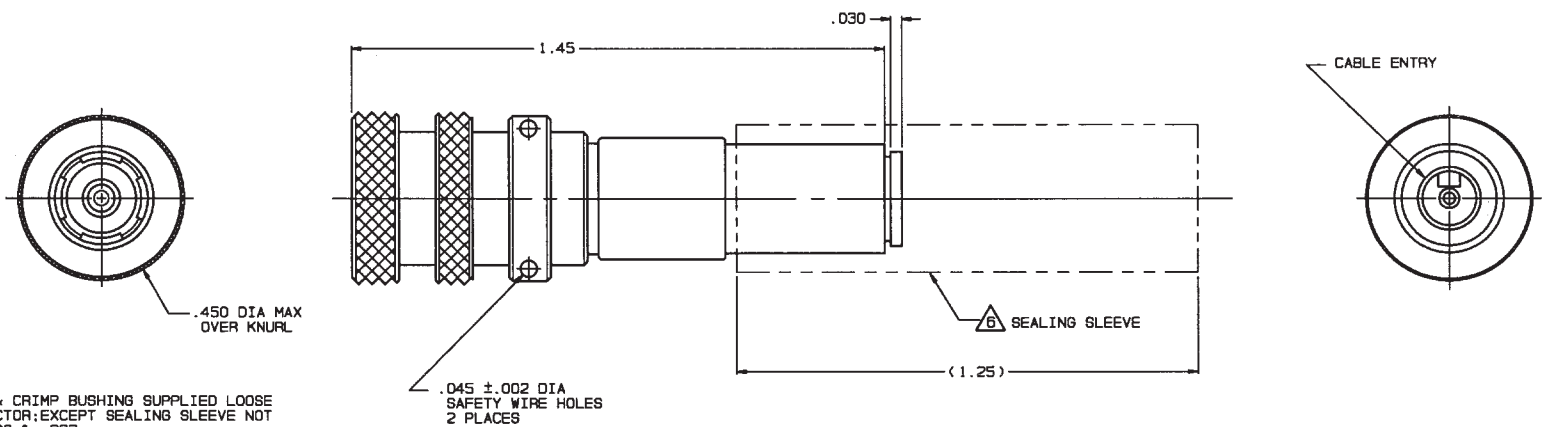

SEALING SLEEVE & CRIMP BUSHING SUPPLIED LOOSE WITH EACH CONNECTOR; EXCEPT SEALING SLEEVE NOT USED ON -205, -208 & -223

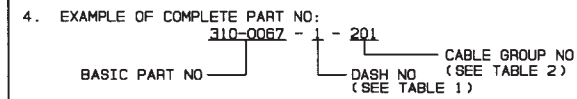
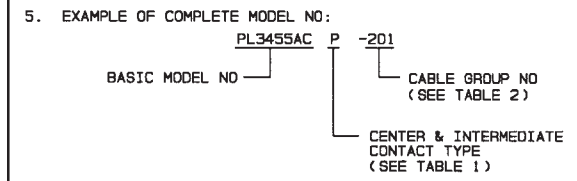

3. CONCENTRIC TWINAX 4 PIECE ASSY, FULL CRIMP CABLE PLUG, SOCKET CENTER CONTACT AND PIN INTERMEDIATE CONTACT OR PIN CENTER CONTACT AND SOCKET INTERMEDIATE CONTACT
2. TFS-1U (500 HRS SALT SPRAY; NICKEL)
1. ALL DIM ARE IN INCHES

-1 -202 SHOWN



QTY	DESCRIPTION	PART NUMBER	ITEM
TOL UNLESS SPECIFIED xxx ± .03 xxx ± .005 xxx ± .0005 ANGLES:	<b>TROMPETER</b> RF connectivity	PL3455ACP/S	
DWN DKC 12-3-92	MATERIAL CODE IDENT	DRAWING NO. 310-0067	REV F
CHK <i>DKC</i>	14949		
ENGR <i>DKC</i>			
APPR <i>DKC</i> 12/29/92	SCALE 4/1	DATE 10-7-87	SHEET 1 OF 2

NEXT ASSY

# RED INDICATES ORIGINAL

DISK # K 1	DWG SIZE B	DATA CONTAINED IN THIS DOCUMENT IS PROPRIETARY TO TROMPETER ELECTRONICS INC. AND SHALL NOT BE DISCLOSED, COPIED OR USED FOR PROCUREMENT OR MANUFACTURE WITHOUT EXPRESS WRITTEN PERMISSION.	REVISIONS			310-0067		SH 2
			REV	EO	DESCRIPTION	DWN	APPROVED	DATE

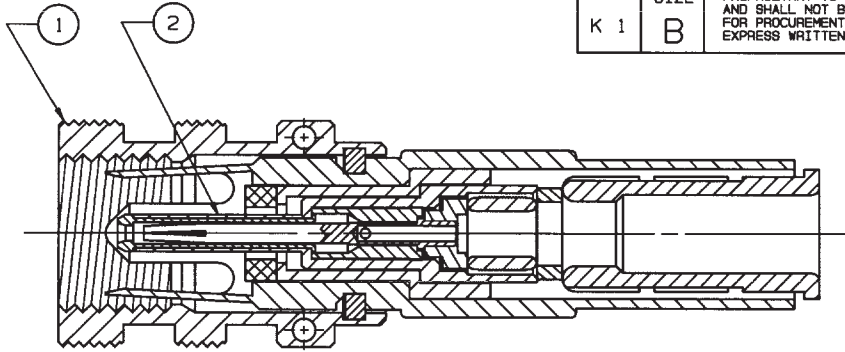

-1-303 SHOWN

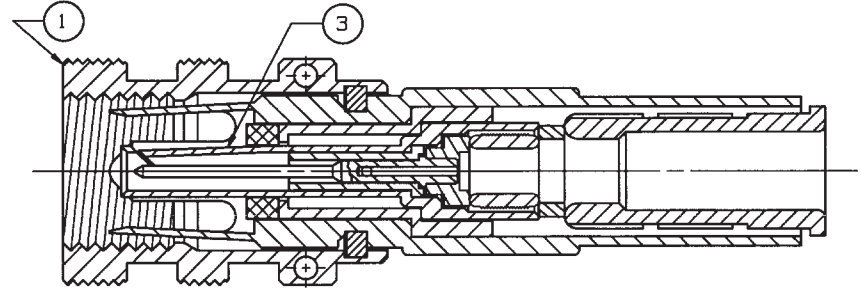

-2-303 SHOWN

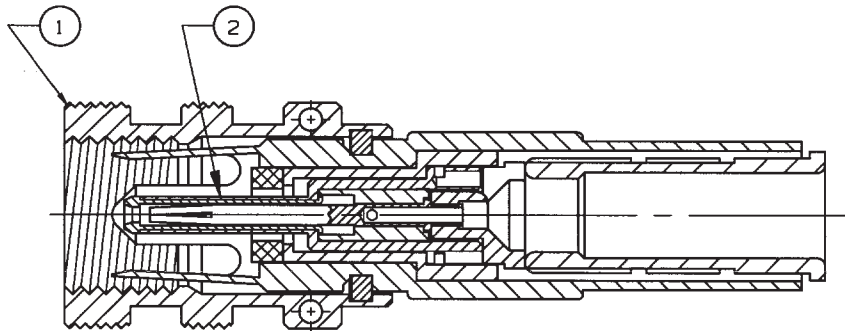

-1-221 SHOWN

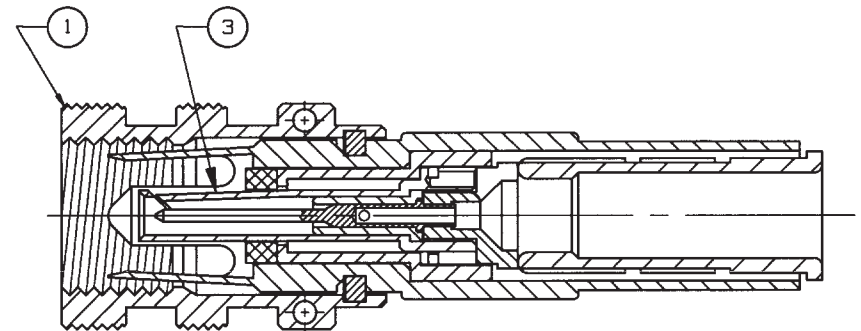

-2-221 SHOWN

1 DASH NO SAME AS CABLE GROUP NO

1	SP450AC - 1			8-2496-	1		3
1	PS450AC - 1			8-2495-	1		2
1	1	BODY ASSY. PL3455AC - 1		8-2554-	1		1
		DESCRIPTION		PART NUMBER			ITEM
-2	-1	TOL UNLESS SPECIFIED .XX ± .XXX ± .XXXX ± ANGLES ±		PL3455ACP/S			
DWN	DKC	12-3-92	MATERIAL	CODE IDENT	DRAWING NO.		REV
CHK	DKG	12/4/92		14949	310-0067		F
ENGR							
APPR	KJ	12/29/92	SCALE 4/1	DATE 10-7-87	SHEET 2		

NEXT ASSY