

- NOTES:
 1. ALL PARTS TO BE BULK PACKED.
 2. CONTACTS SHIPPED ASSEMBLED INTO CONNECTOR WITH SOLDER CUPS FACING THE KEY
 3. DIMENSIONS ARE REFERENCE EXCEPT THOSE WITH A TOLERANCE

ASS'Y P/N	CABLE O.D.
W8882-XSG-P-513	130-.150 [3.3-3.8]
W8882-XSG-P-516	.160-.180 [4.1-4.6]
W8882-XSG-P-519	.190-.210 [4.8-5.3]
W8882-XSG-P-522	.220-.250 [5.6-6.3]
W8882-XSG-P-526	.250-.270 [6.3-6.9]
W8882-XSG-P-528	.265-.285 [6.7-7.2]

ASSEMBLY P/N	CONTACT QTY
W8882-8SG-P-5XX	8
W8882-9SG-P-5XX	9
W8882-10SG-P-5XX	10
W8882-XSG-P-5XX	

GROMMET SIZE
 NUMBER OF CONTACTS

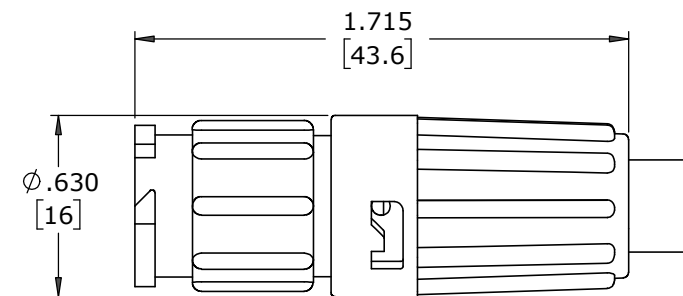

SHOW ASSEMBLED
 FOR CUSTOMER REFERENCE ONLY

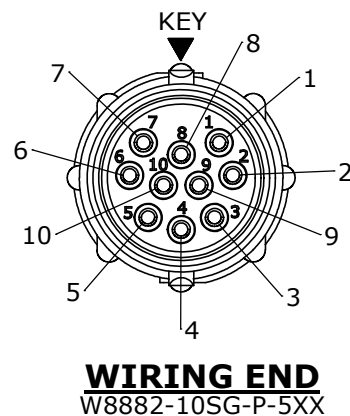
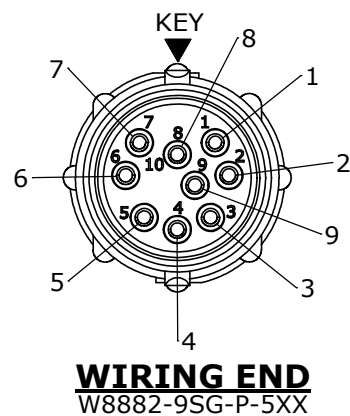
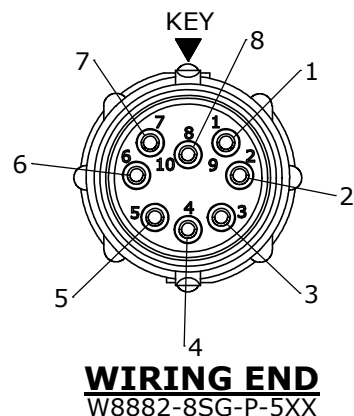
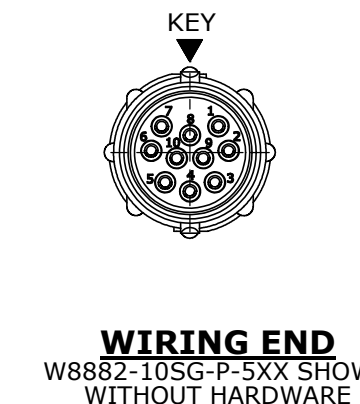
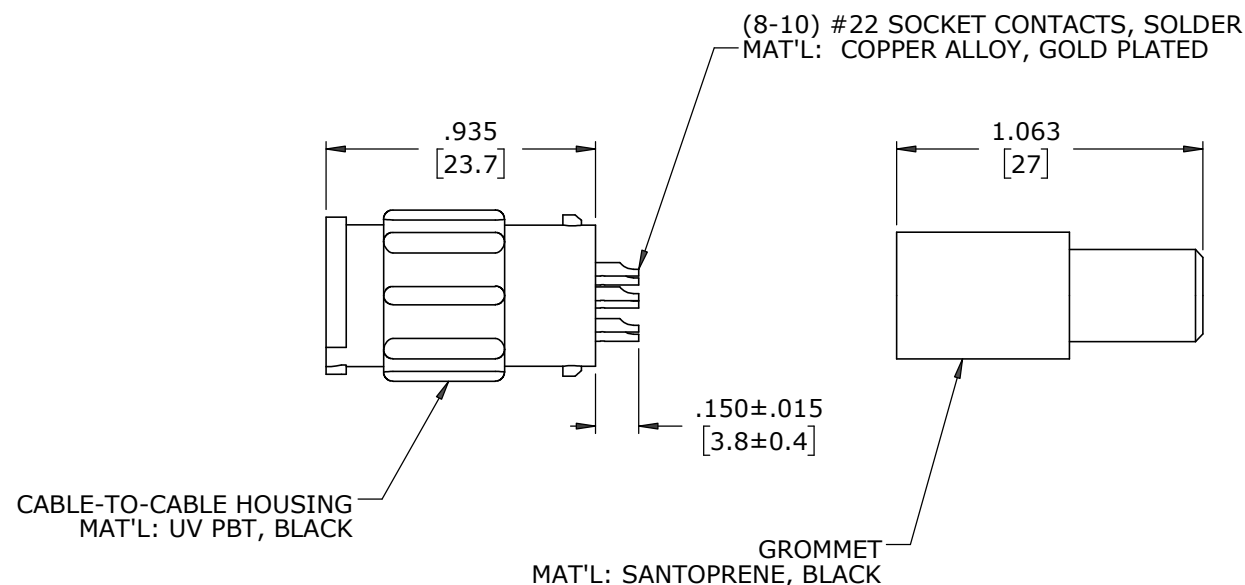
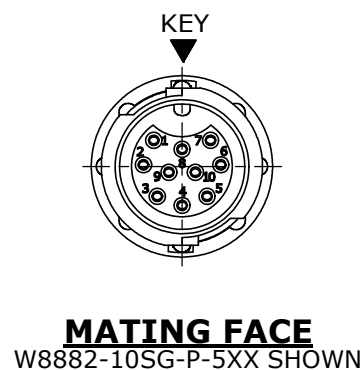

CUSTOMER APPROVAL

THIS DOCUMENT CONTAINS CONFIDENTIAL INFORMATION PROPRIETARY TO CONXALL CORPORATION. ANY REPRODUCTION, DISCLOSURE, OR USE OF THIS DOCUMENT /INFORMATION IS EXPRESSLY PROHIBITED UNLESS AUTHORIZED IN WRITING BY CONXALL CORPORATION.

APPROVED BY: _____
 DATE: _____

RoHS COMPLIANT

MA	07-15-20	RELEASED PER PDR 16014-10
PNK	03-20-18	PDR 16014
REV.	INIT.	DATE
DESCRIPTION		ORIG. DRAWN BY: DATE: 03-20-18
ALL INFORMATION ILLUSTRATED IS THE PROPERTY OF CONXALL CORPORATION. UNAUTHORIZED DUPLICATION OR DISTRIBUTION OF THIS DOCUMENT IS PROHIBITED.		CHECKED BY:
ALL UNITS ARE IN FEET, INCHES, FRACTION OF INCHES AND DECIMALS. UNLESS OTHERWISE SPECIFIED TOLERANCES: 3 PLACE DECIMALS ±.010 ANGLES ±1° FRACTIONS ±1/16		APPROVED BY:
SCALE	SIZE	SHEET
NTS	B	1 OF 1
FILE: W8882-XSG-P-5XX	DIRECTORY: SLW	PART NUMBER: W8882-XSG-P-5XX
TITLE: CABLE-TO-CABLE ASSEMBLY (8-10) #22 SOCKET CONTACTS, SOLDER INSTA-CLICK™ MINI-CON-X		CUSTOMER: STANDARD PRODUCT
- CRITICAL CHARACTERISTIC FLAG PER SPEC. XXXX		REV A



601 E. WILDWOOD VILLA PARK, IL 60181