

MBRA340T3

Surface Mount Schottky Power Rectifier SMA Power Surface Mount Package

Employing the Schottky Barrier principle in a large area metal-to-silicon power diode. State of the art geometry features epitaxial construction with oxide passivation and metal overlay contact. Ideally suited for low voltage, high frequency rectification, or as free wheeling and polarity diodes in surface mount applications where compact size and weight are critical to the system.

Features

- Small Compact Surface Mountable Package with J-Bent Leads
- Rectangular Package for Automated Handling
- Highly Stable Oxide Passivated Junction
- Very Low Forward Voltage Drop
- Guardring for Stress Protection
- Pb-Free Package is Available

Mechanical Characteristics:

- Case: Epoxy, Molded
- Weight: 70 mg (approximately)
- Finish: All External Surfaces Corrosion Resistant and Terminal Leads are Readily Solderable
- Lead and Mounting Surface Temperature for Soldering Purposes: 260°C Max. for 10 Seconds
- Shipped in 12 mm tape, 5000 units per 13 inch reel
- Polarity: Cathode Lead Indicated by Polarity Band
- ESD Ratings: Machine Model = C
Human Body Model = 3B
- Device Meets MSL 1 Requirements

MAXIMUM RATINGS

| Rating | Symbol | Value | Unit |
|--|---------------------------------|-------------|------------------|
| Peak Repetitive Reverse Voltage Working Peak Reverse Voltage DC Blocking Voltage | V_{RRM} V_{RWM} V_R | 40 | V |
| Average Rectified Forward Current (At Rated V_R , $T_L = 100^\circ\text{C}$) | I_O | 3.0 | A |
| Non-Repetitive Peak Surge Current (Surge Applied at Rated Load Conditions Halfwave, Single Phase, 60 Hz) | I_{FSM} | 100 | A |
| Storage/Operating Case Temperature | T_{stg} , T_C | -55 to +150 | °C |
| Operating Junction Temperature (Note 1) | T_J | -55 to +150 | °C |
| Voltage Rate of Change (Rated V_R , $T_J = 25^\circ\text{C}$) | dv/dt | 10,000 | V/ μs |

Stresses exceeding Maximum Ratings may damage the device. Maximum Ratings are stress ratings only. Functional operation above the Recommended Operating Conditions is not implied. Extended exposure to stresses above the Recommended Operating Conditions may affect device reliability.

1. The heat generated must be less than the thermal conductivity from Junction-to-Ambient: $dP_D/dT_J < 1/R_{\theta JA}$.



ON Semiconductor®

<http://onsemi.com>

SCHOTTKY BARRIER RECTIFIER 3.0 AMPERES 40 VOLTS

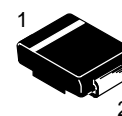
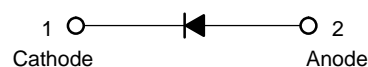

SMA
CASE 403D
PLASTIC

MARKING DIAGRAM

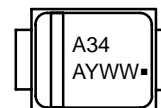

- A34 = Device Code
- A = Assembly Location
- Y = Year
- WW = Work Week
- = Pb-Free Package

ORDERING INFORMATION

| Device | Package | Shipping† |
|------------|------------------|------------------|
| MBRA340T3 | SMA | 5000/Tape & Reel |
| MBRA340T3G | SMA (Pb-Free) | 5000/Tape & Reel |

†For information on tape and reel specifications, including part orientation and tape sizes, please refer to our Tape and Reel Packaging Specification Brochure, BRD8011/D.

MBRA340T3

THERMAL CHARACTERISTICS

| Characteristic | Symbol | Value | Unit |
|---|-----------------|-------|-----------------------------|
| Thermal Resistance – Junction-to-Lead (Note 2) | $R_{\theta JL}$ | 15 | $^{\circ}\text{C}/\text{W}$ |
| Thermal Resistance – Junction-to-Ambient (Note 2) | $R_{\theta JA}$ | 81 | $^{\circ}\text{C}/\text{W}$ |

ELECTRICAL CHARACTERISTICS

| | | | | |
|---|-------|----------------------------|-----------------------------|-------|
| Maximum Instantaneous Forward Voltage (Note 3) ($I_F = 3.0 \text{ A}$) | V_F | $T_J = 25^{\circ}\text{C}$ | $T_J = 100^{\circ}\text{C}$ | Volts |
| | | 0.450 | 0.390 | |
| Maximum Instantaneous Reverse Current ($V_R = 40 \text{ V}$) | I_R | $T_J = 25^{\circ}\text{C}$ | $T_J = 100^{\circ}\text{C}$ | mA |
| | | 0.3 | 15 | |

- Mounted on 2" Square PC Board with 1" Square Total Pad Size, PC Board FR4.
- Pulse Test: Pulse Width $\leq 250 \mu\text{s}$, Duty Cycle $\leq 2.0\%$.

TYPICAL CHARACTERISTICS

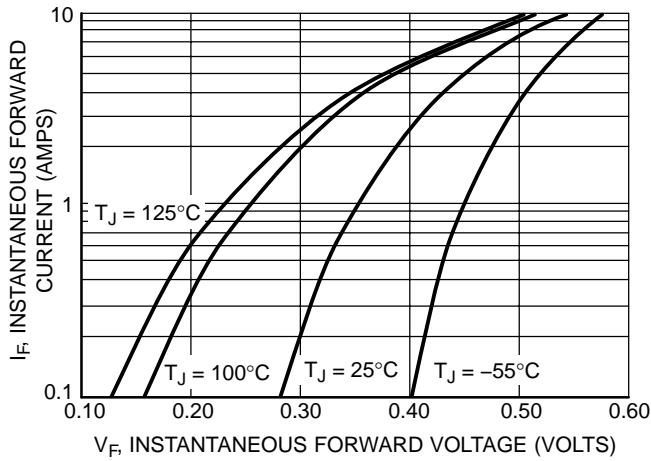

Figure 1. Typical Forward Voltage

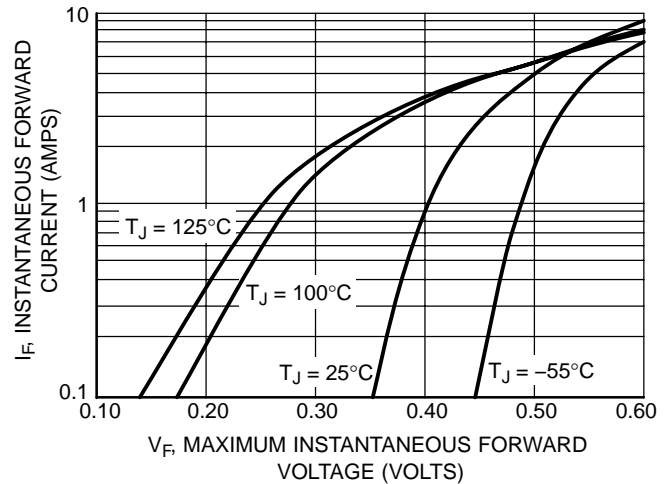

Figure 2. Maximum Forward Voltage

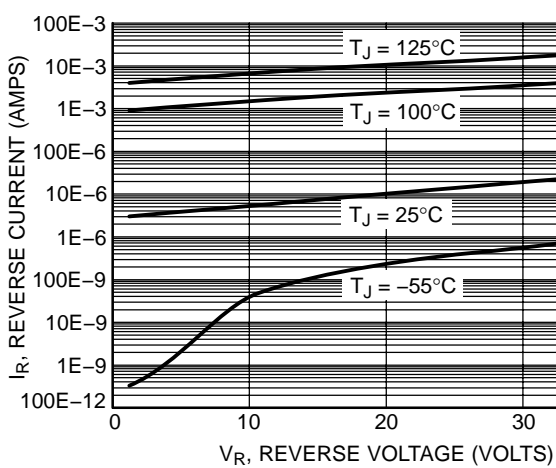

Figure 3. Typical Reverse Current

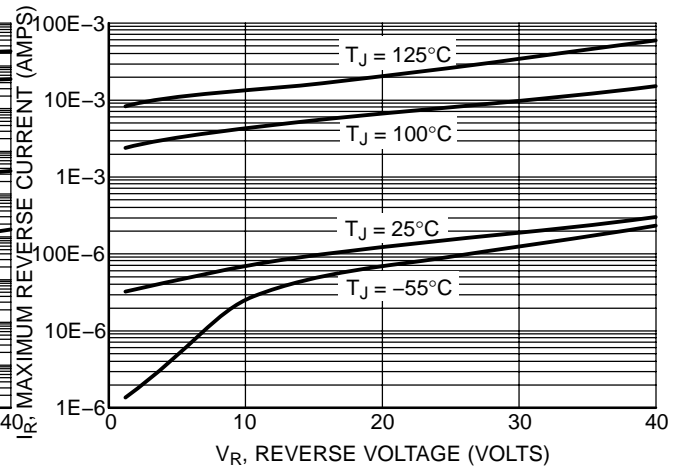

Figure 4. Maximum Reverse Current

MBRA340T3

TYPICAL CHARACTERISTICS

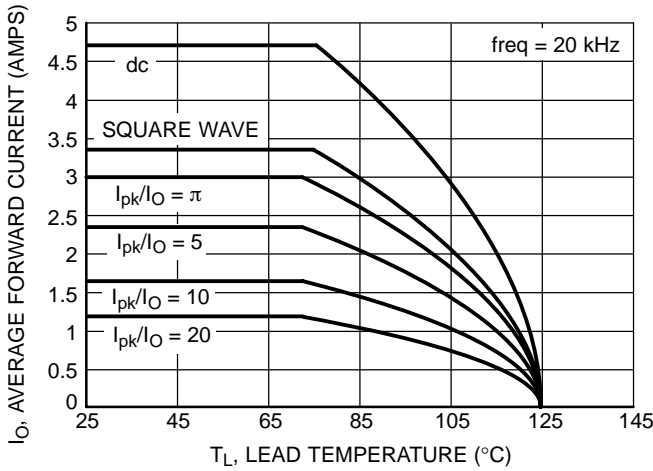

Figure 5. Current Derating

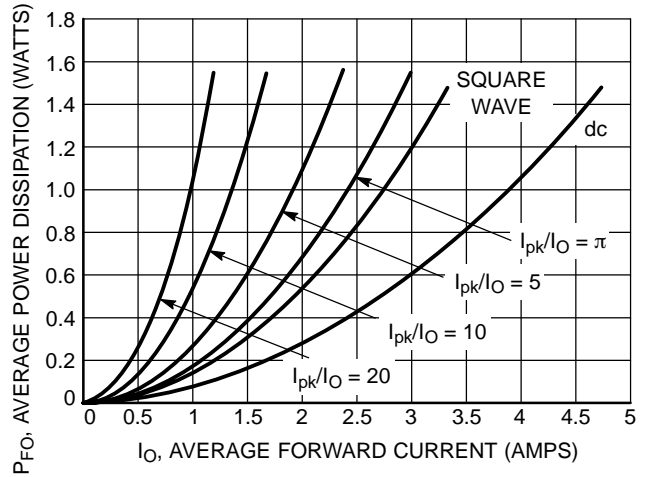

Figure 6. Forward Power Dissipation

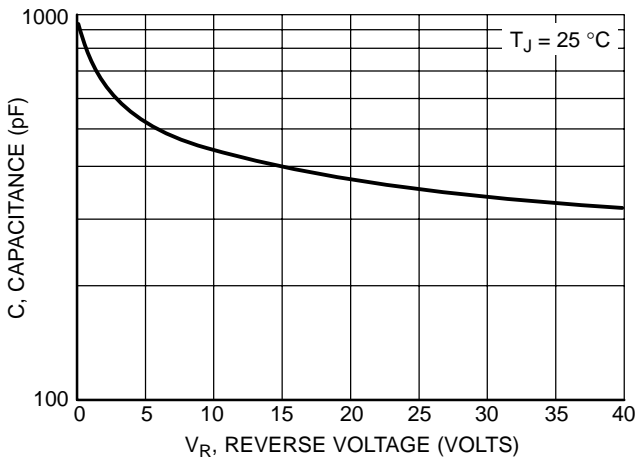

Figure 7. Capacitance

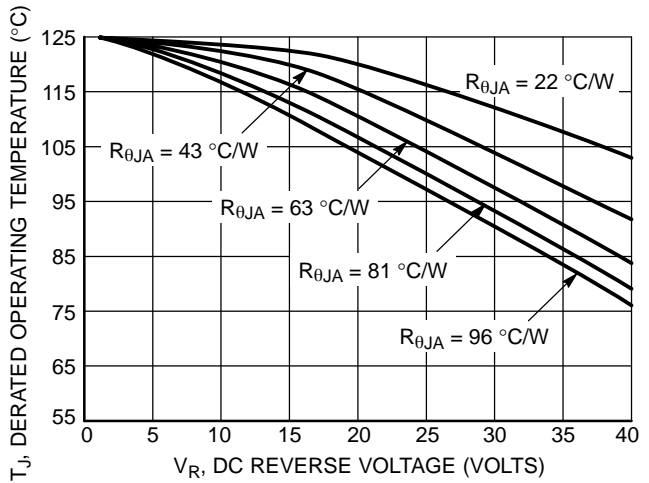

Figure 8. Typical Operating Temperature Derating

MBRA340T3

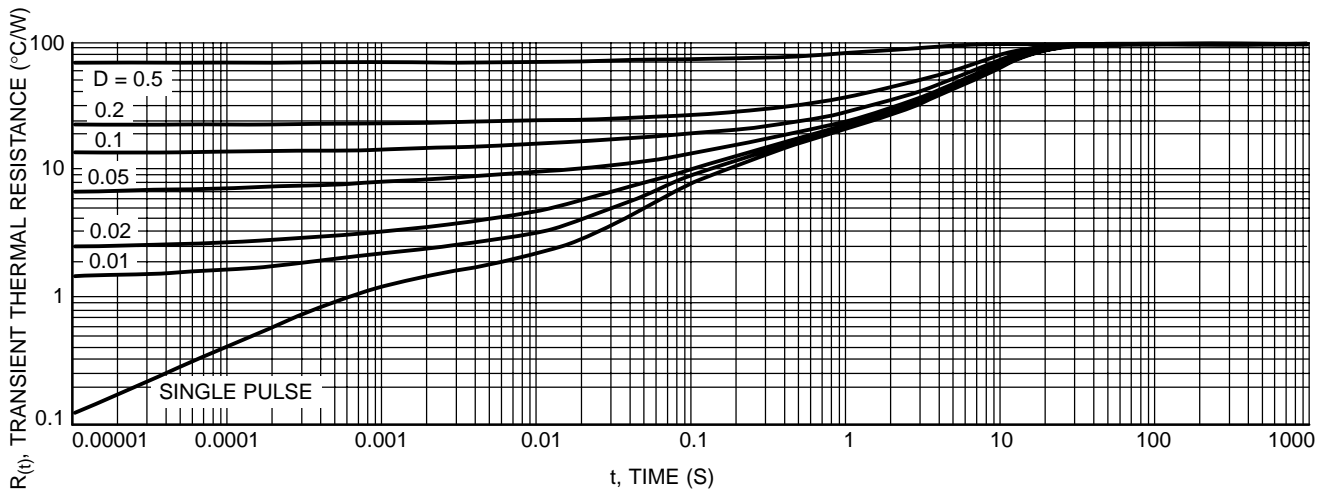

Figure 9. Thermal Response, Junction-to-Ambient (min pad)

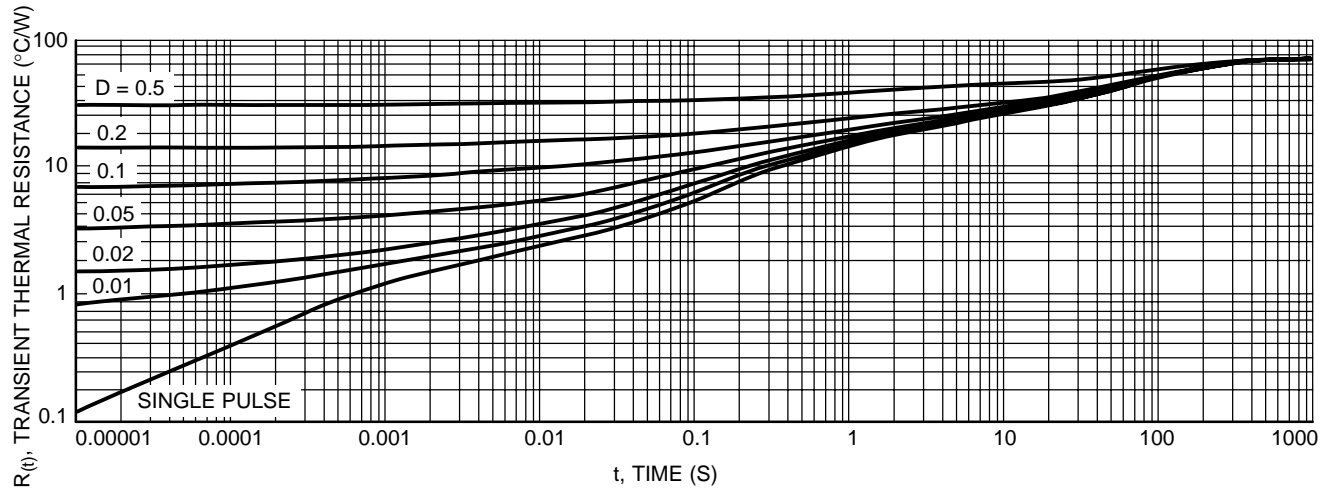
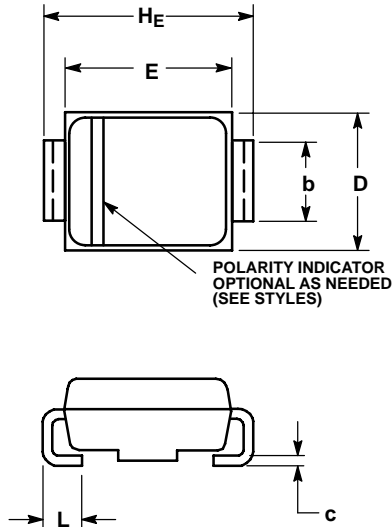

Figure 10. Thermal Response, Junction to Ambient (1 inch pad)

MBRA340T3

PACKAGE DIMENSIONS

SMA CASE 403D-02 ISSUE C



- NOTES:
 1. DIMENSIONING AND TOLERANCING PER ANSI Y14.5M, 1982.
 2. CONTROLLING DIMENSION: INCH.
 3. 403D-01 OBSOLETE, NEW STANDARD IS 403D-02.

| DIM | MILLIMETERS | | | INCHES | | |
|-------|-------------|------|------|--------|-------|-------|
| | MIN | NOM | MAX | MIN | NOM | MAX |
| A | 1.91 | 2.16 | 2.41 | 0.075 | 0.085 | 0.095 |
| A1 | 0.05 | 0.10 | 0.15 | 0.002 | 0.004 | 0.006 |
| b | 1.27 | 1.45 | 1.63 | 0.050 | 0.057 | 0.064 |
| c | 0.15 | 0.28 | 0.41 | 0.006 | 0.011 | 0.016 |
| D | 2.29 | 2.60 | 2.92 | 0.090 | 0.103 | 0.115 |
| E | 4.06 | 4.32 | 4.57 | 0.160 | 0.170 | 0.180 |
| H_E | 4.83 | 5.21 | 5.59 | 0.190 | 0.205 | 0.220 |
| L | 0.76 | 1.14 | 1.52 | 0.030 | 0.045 | 0.060 |

SOLDERING FOOTPRINT*

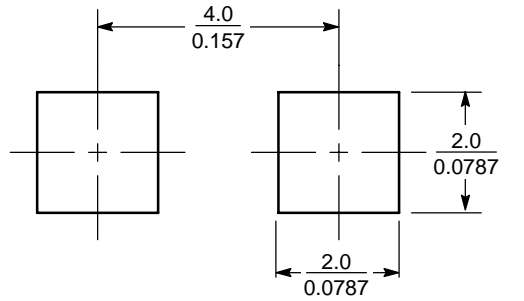

SCALE 8:1 ($\frac{\text{mm}}{\text{inches}}$)

*For additional information on our Pb-Free strategy and soldering details, please download the ON Semiconductor Soldering and Mounting Techniques Reference Manual, SOLDERRM/D.

ON Semiconductor and are registered trademarks of Semiconductor Components Industries, LLC (SCILLC). SCILLC reserves the right to make changes without further notice to any products herein. SCILLC makes no warranty, representation or guarantee regarding the suitability of its products for any particular purpose, nor does SCILLC assume any liability arising out of the application or use of any product or circuit, and specifically disclaims any and all liability, including without limitation special, consequential or incidental damages. "Typical" parameters which may be provided in SCILLC data sheets and/or specifications can and do vary in different applications and actual performance may vary over time. All operating parameters, including "Typicals" must be validated for each customer application by customer's technical experts. SCILLC does not convey any license under its patent rights nor the rights of others. SCILLC products are not designed, intended, or authorized for use as components in systems intended for surgical implant into the body, or other applications intended to support or sustain life, or for any other application in which the failure of the SCILLC product could create a situation where personal injury or death may occur. Should Buyer purchase or use SCILLC products for any such unintended or unauthorized application, Buyer shall indemnify and hold SCILLC and its officers, employees, subsidiaries, affiliates, and distributors harmless against all claims, costs, damages, and expenses, and reasonable attorney fees arising out of, directly or indirectly, any claim of personal injury or death associated with such unintended or unauthorized use, even if such claim alleges that SCILLC was negligent regarding the design or manufacture of the part. SCILLC is an Equal Opportunity/Affirmative Action Employer. This literature is subject to all applicable copyright laws and is not for resale in any manner.

PUBLICATION ORDERING INFORMATION

LITERATURE FULFILLMENT:
 Literature Distribution Center for ON Semiconductor
 P.O. Box 5163, Denver, Colorado 80217 USA
Phone: 303-675-2175 or 800-344-3860 Toll Free USA/Canada
Fax: 303-675-2176 or 800-344-3867 Toll Free USA/Canada
Email: orderlit@onsemi.com

N. American Technical Support: 800-282-9855 Toll Free
 USA/Canada
Europe, Middle East and Africa Technical Support:
 Phone: 421 33 790 2910
Japan Customer Focus Center
 Phone: 81-3-5773-3850

ON Semiconductor Website: www.onsemi.com
Order Literature: <http://www.onsemi.com/orderlit>
 For additional information, please contact your local Sales Representative