

1 2 3 4 5 6

A

B

C

D

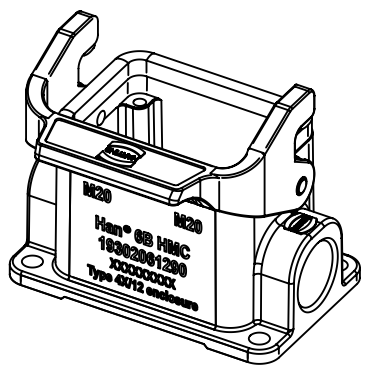
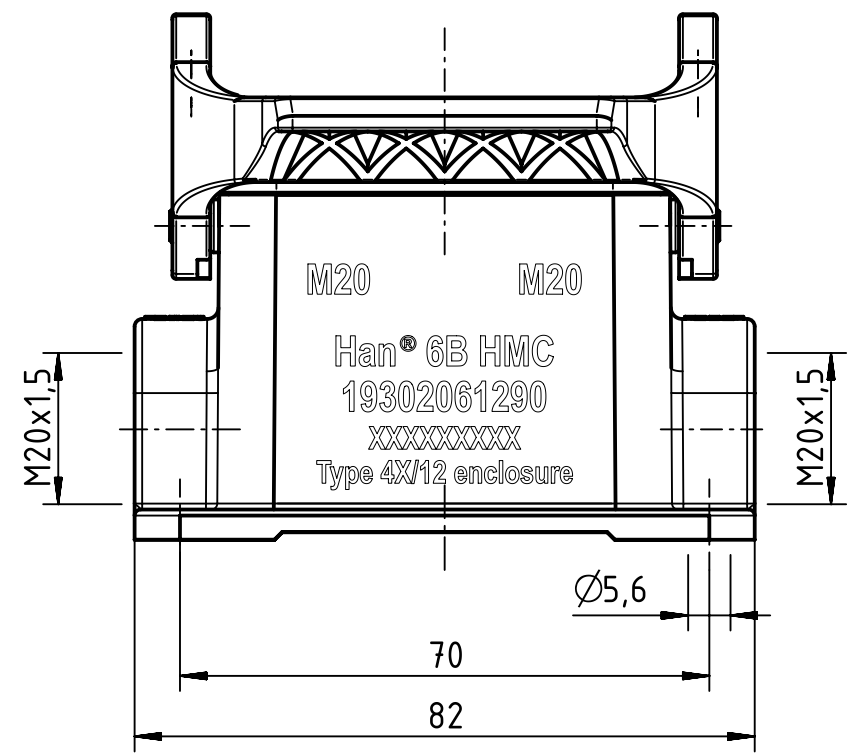
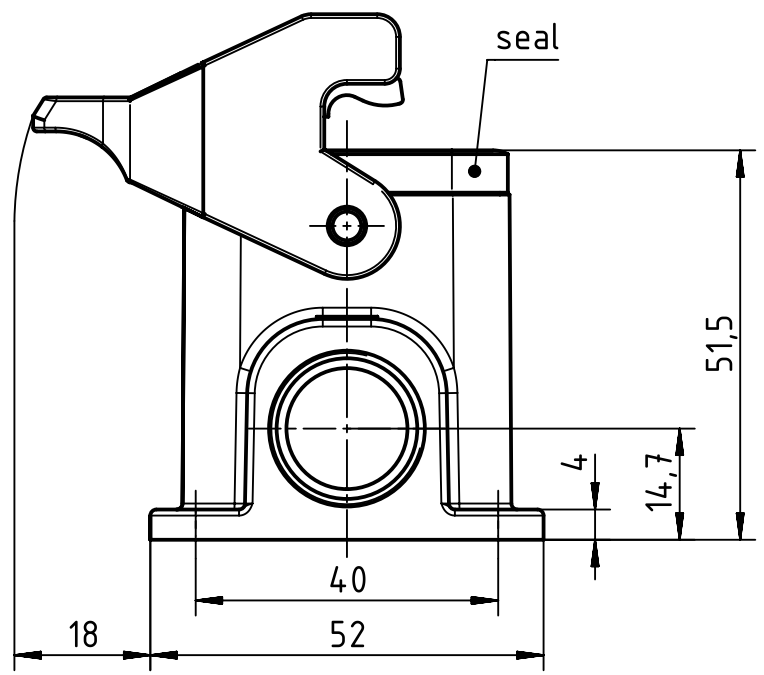

	All Dimensions in mm Original Size DIN A4		Scale 1:1	Free size tol.		Ref.
						Sub.
	All rights reserved		Created by SPRENB	Inspected by SUNDERMEIER	Standardisation TIEMANNA	Date 2020-01-30
	Department EL PD		Title Han 6B-HMC-HSM2-SL-M20			State Final Release
HARTING Electric GmbH & Co. KG D-32339 Espelkamp			Type TB	Number 19 30 206 1290		Doc-Key / ECM-Nr. 100705972/UGD/004/B 500000165903
					Rev. B	Page 1/1