

## DETAILS

<b>Product Number</b>	C12828_EVA-O
<b>Family</b>	Eva
<b>Type</b>	Lens
<b>Color</b>	clear
<b>Diameter</b>	35 mm
<b>Height</b>	16,4 mm
<b>Style</b>	round
<b>Optic Material</b>	PMMA
<b>Holder Material</b>	
<b>Fastening</b>	
<b>Status</b>	production ready
<b>ROHS Compliant</b>	Yes
<b>Date Updated</b>	22/07/2016

## OPTICAL PROPERTIES

LED	Viewing	Light	Efficiency	cd/lm	Connector
	Angle	Beam			
XM-L	15.5+39 deg	Oval	86 %	3.300	-
MC-E	sim: 16 + 40	Oval	-	-	-
MHB-A	39+18 deg	Oval	81 %	3.100	-
XP-G2	sim: 17+34	Oval	sim: 91 %	sim: 4.000	-
XHP35 HI	39+21 deg	Oval	81 %	2.200	-
LUXEON M/MX	20.5+37 deg	Oval	83 %	2.700	-
LUXEON MZ	39+15 deg	Oval	86 %	4.000	-
LUXEON 5258	sim: 16+37	Oval	sim: 91 %	sim: 3.700	-
NS9x383	39+15 deg	Oval	87 %	3.700	-
NSMx286M	40+20 deg	Oval	86 %	2.570	-
Duris S8	39+17 deg	Oval	88 %	3.700	-
Duris P10	sim: 19+37	Oval	sim: 92 %	sim: 3.320	-
Z8Y15	41+13 deg	Oval	85 %	4.880	-
Z8Y19	41+12 deg	Oval	86 %	4.870	-



Relative intensity of C12828\_EVA-O\_(MH-B)

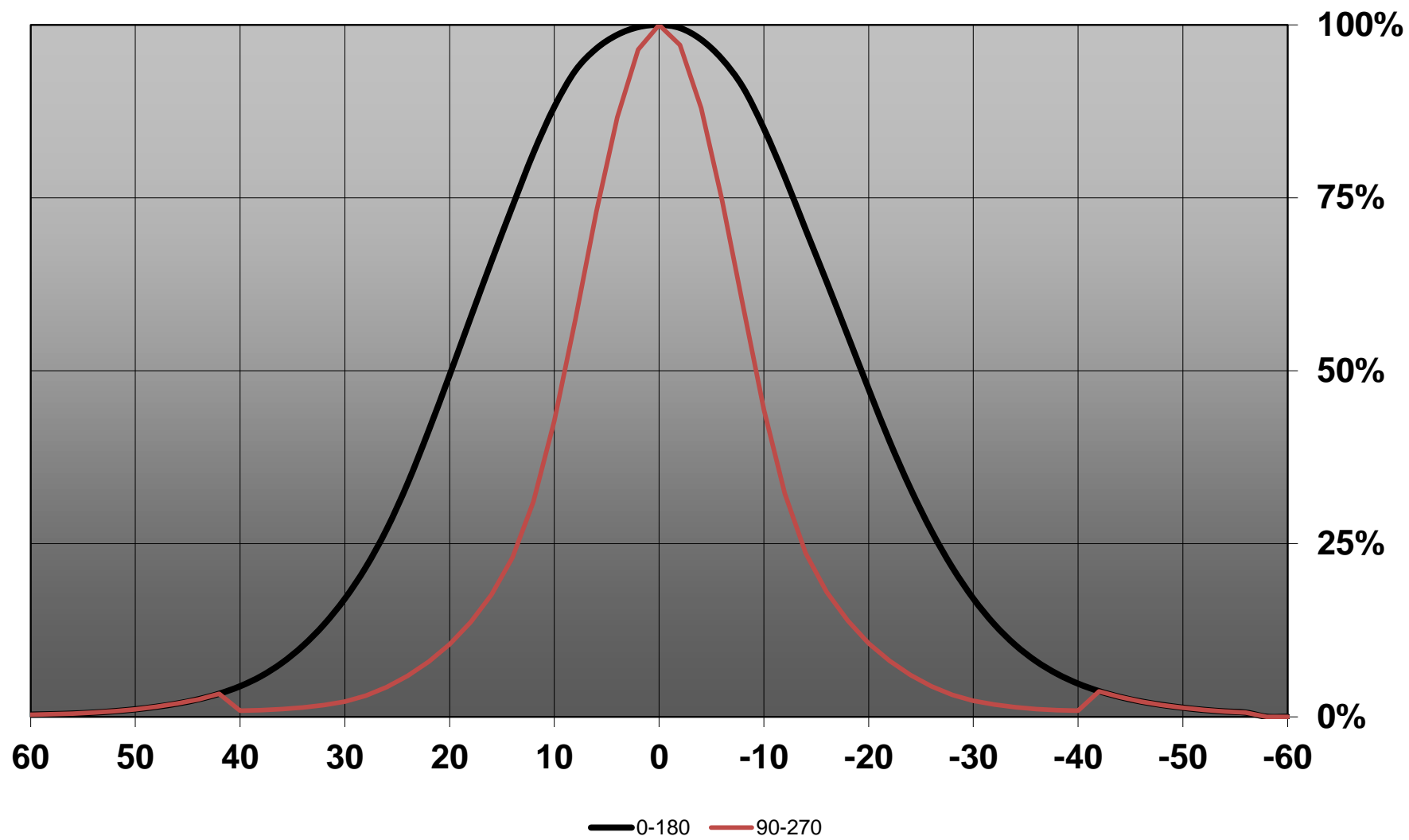

Relative intensity of C12828\_EVA-O\_(XHP35\_HI)

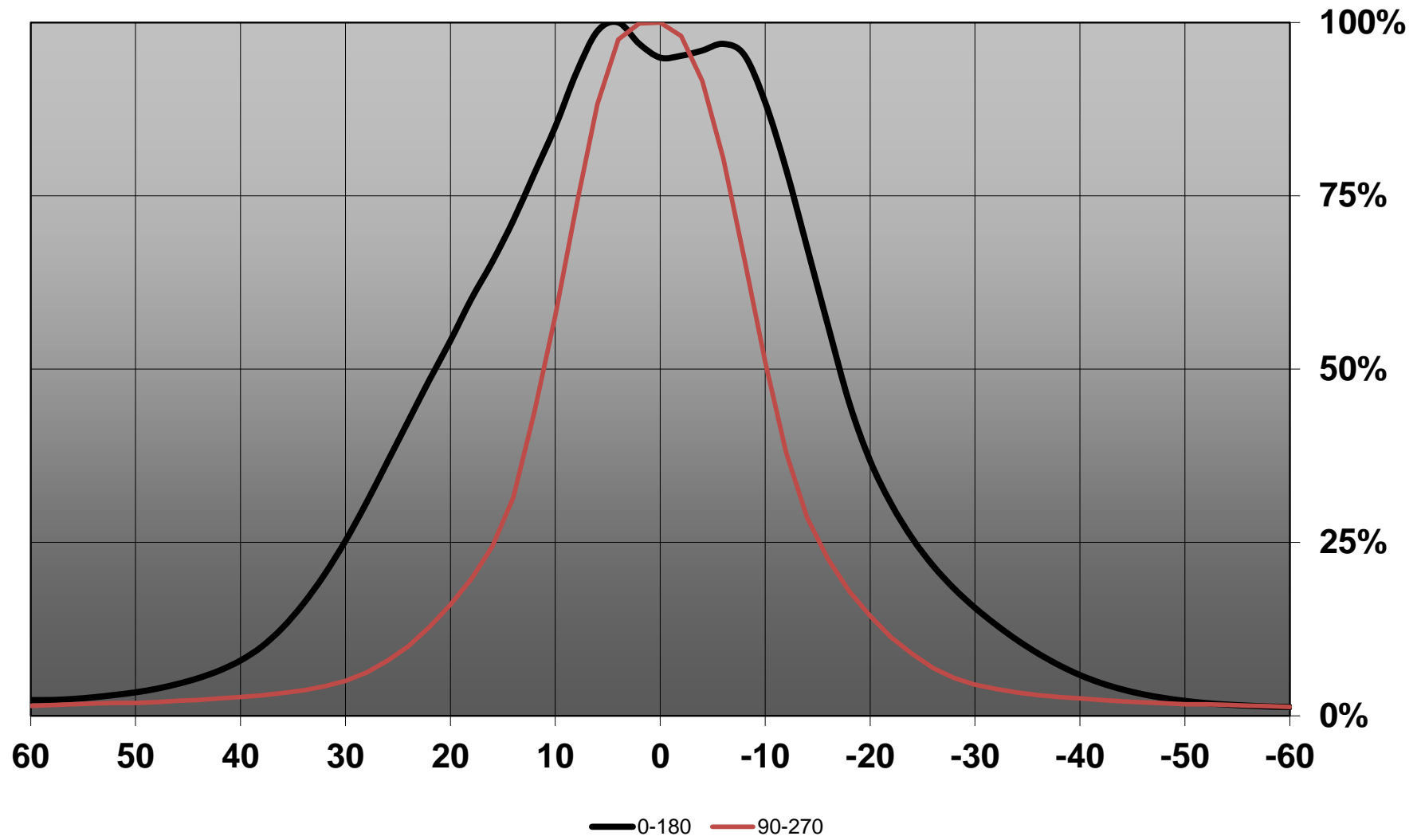

Relative intensity of C12828\_EVA-O\_(SZ8Y15)

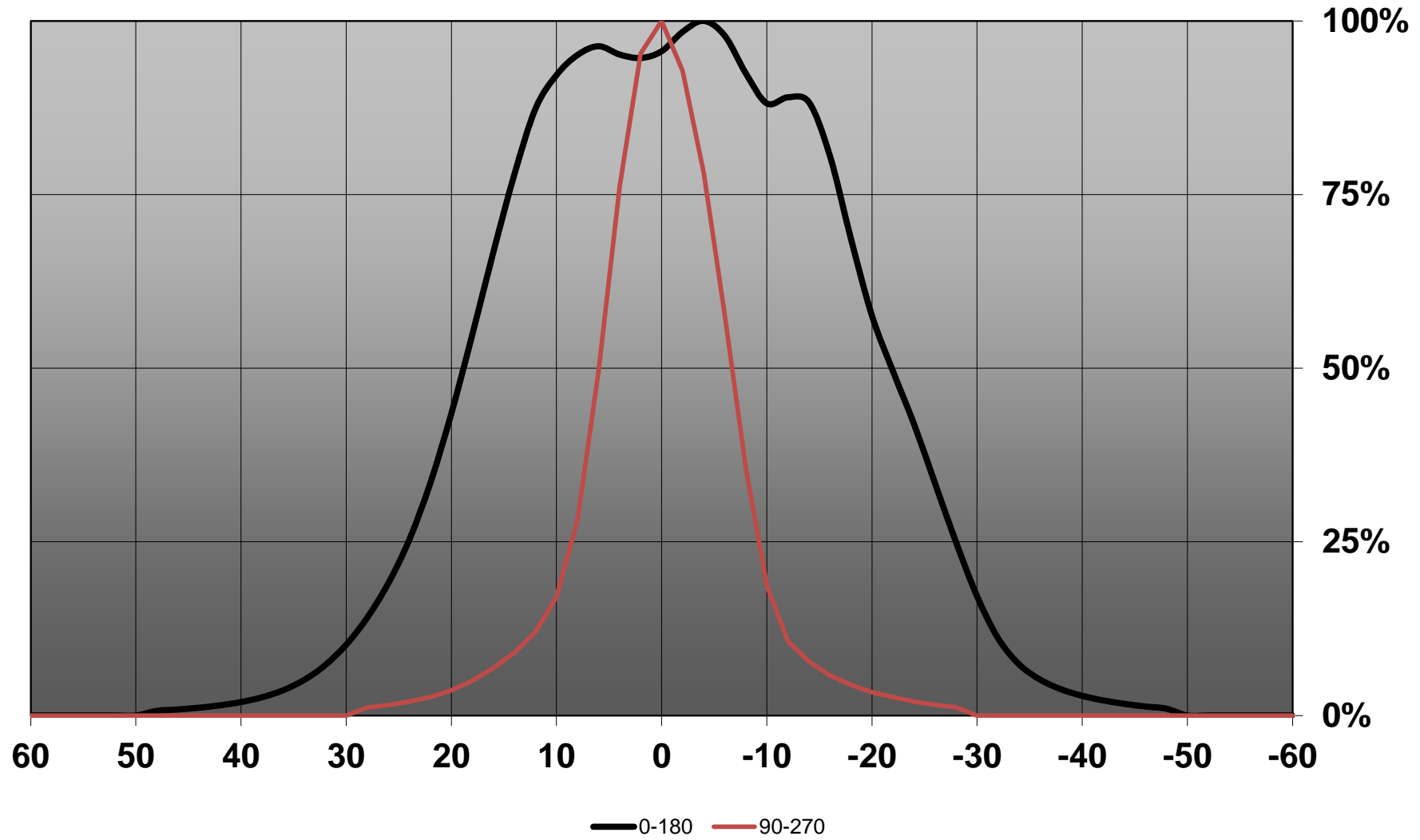

Relative intensity of C12828\_EVA-O\_(SZ8Y19)

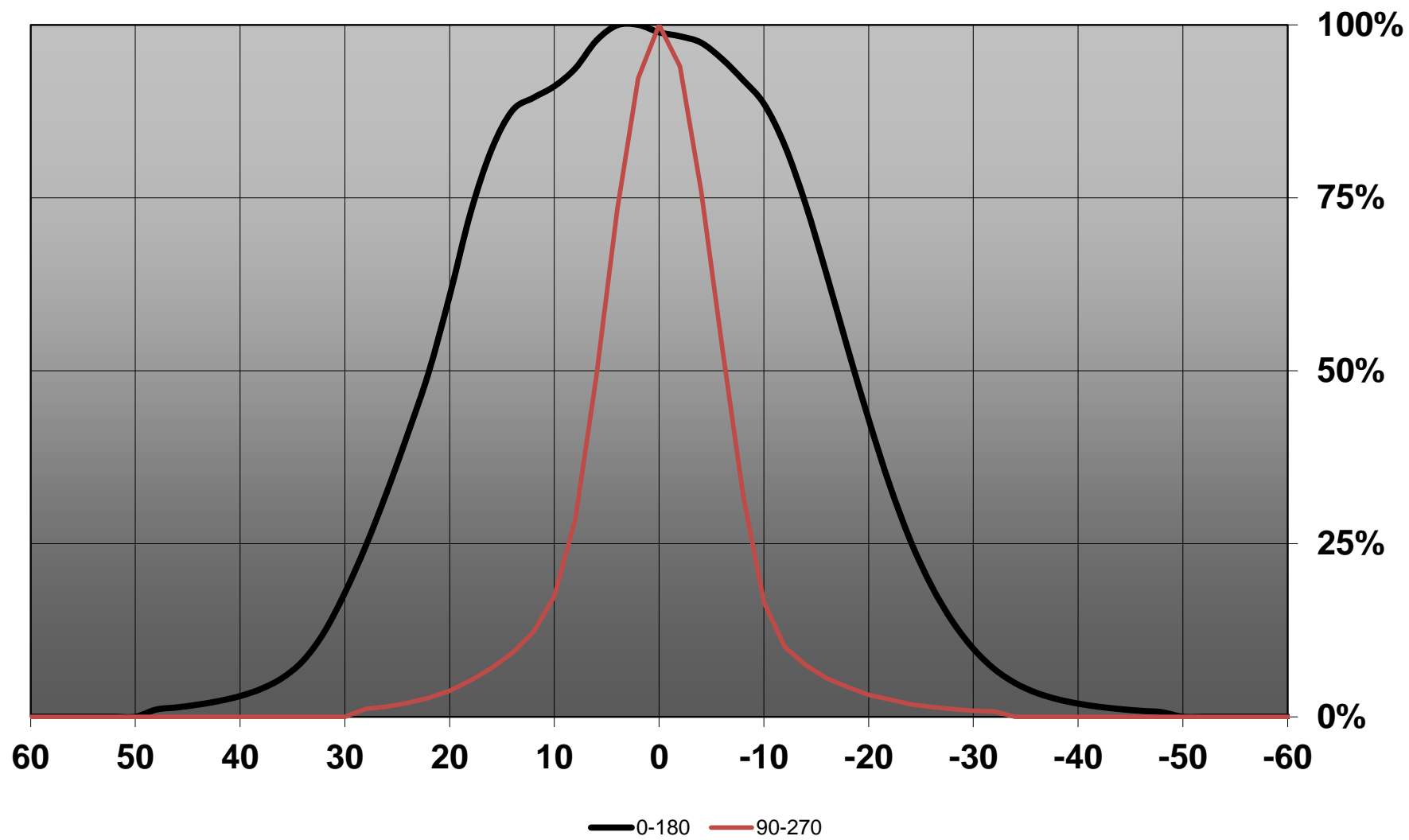

D

C

B

A

4

4

Ø 30.5

16.4

Side view

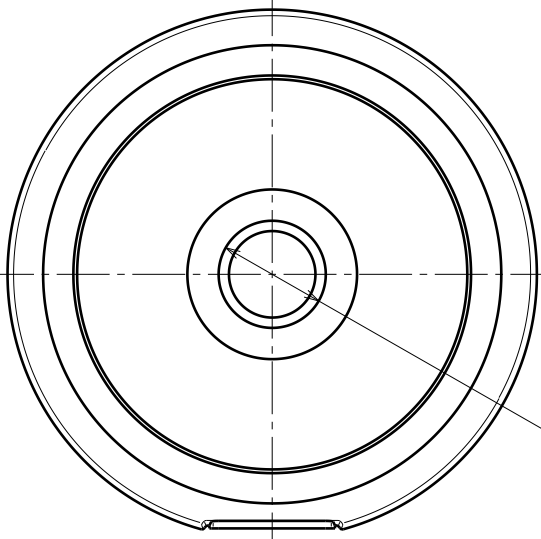

Bottom view

3

3

Ø 35

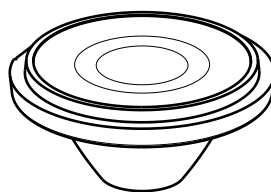

Isometric view

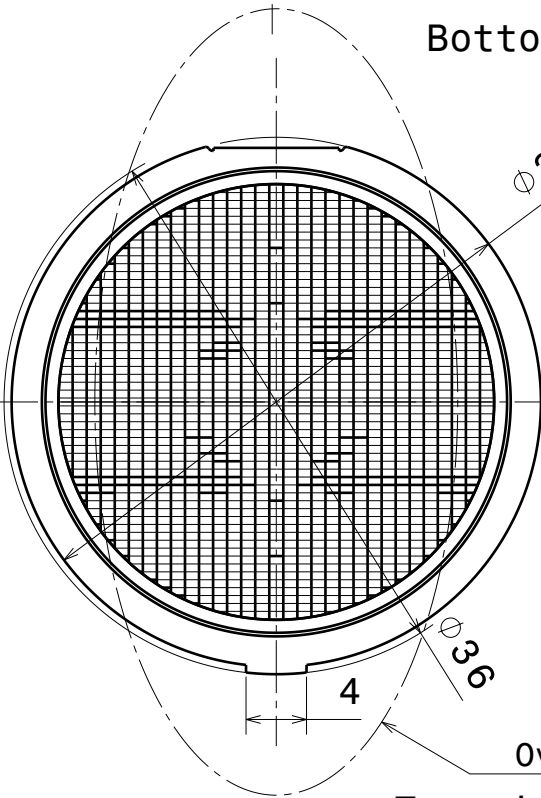

Oval beam direction

Top view

2

2

4

INDEX	PART NO	DESCRIPTION	MATERIAL	COLOUR
1	C12828	EVA-0	PMMA	

Tolerances if not otherwise shown  
 According to DIN ISO 2768-1  
 Linear measures:  
 Up to 30mm class M, otherwise class C.  
 According to DIN ISO 2768-2  
 Form and position: class L

**LEDiL** LediL Oy  
 Salorankatu 10  
 FIN 24240 SALO  
 Finland

THIRD ANGLE PROJECTION:

DRAWING TITLE  
**C12828\_EVA-0**

This drawing is the property of LEDiL Oy. It may not be reproduced, copied or communicated without a written agreement with LEDiL Oy.

SIZE	PART NUMBER
<b>A4</b>	<b>C12828</b>

SCALE	2:1	WEIGHT	6 g	SHEET	1/1
-------	-----	--------	-----	-------	-----

D

A

1

1

Luminaire: LEDIL OY C12828\_EVA-O (XM-L) Efficiency=86%  
Lamps: 1 x Cree XM-L (111lm @ 250mA)

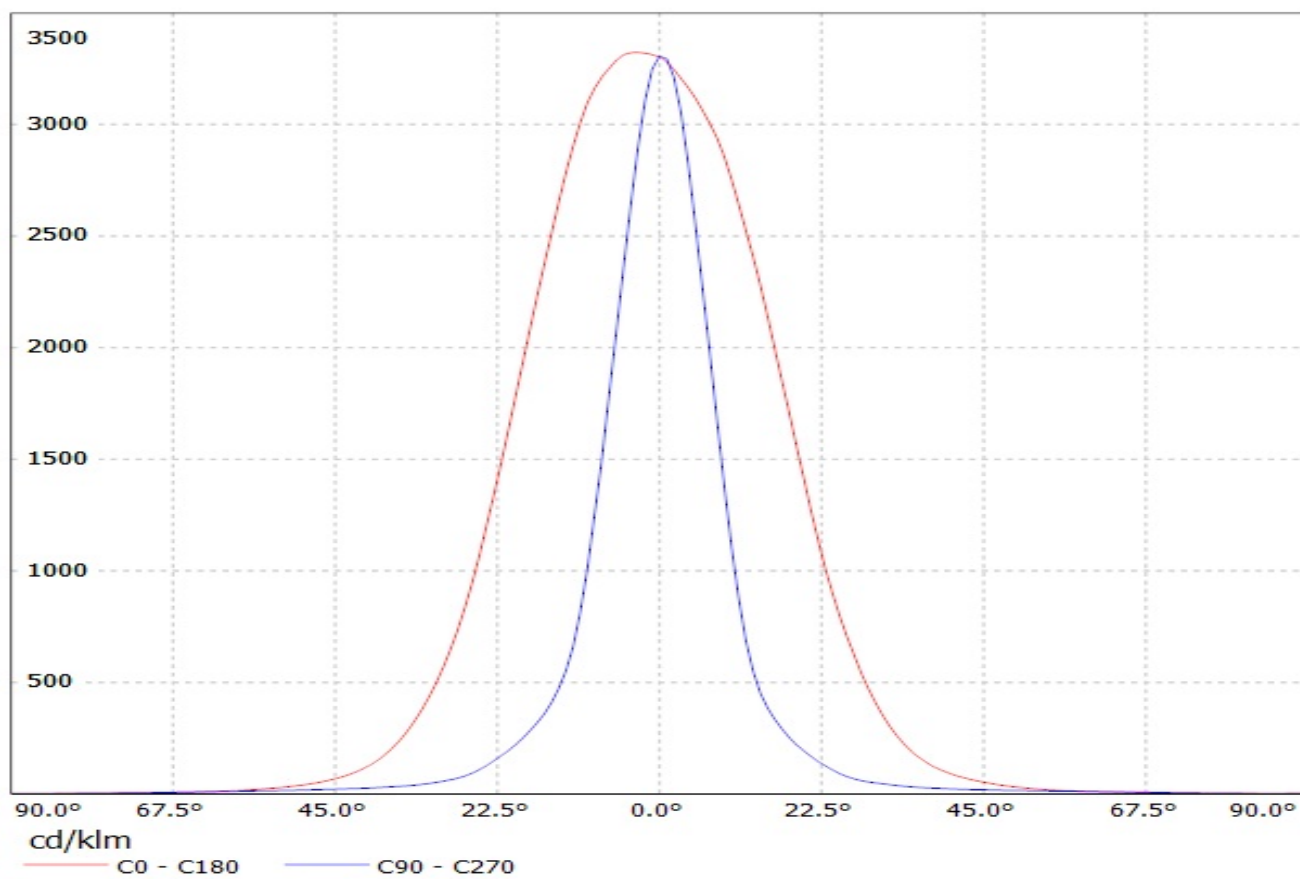

Luminaire: LEDIL OY C12828\_EVA-O (Luxeon M) Efficiency=83%  
Lamps: 1 x Luxeon M (362lm @ 250mA)

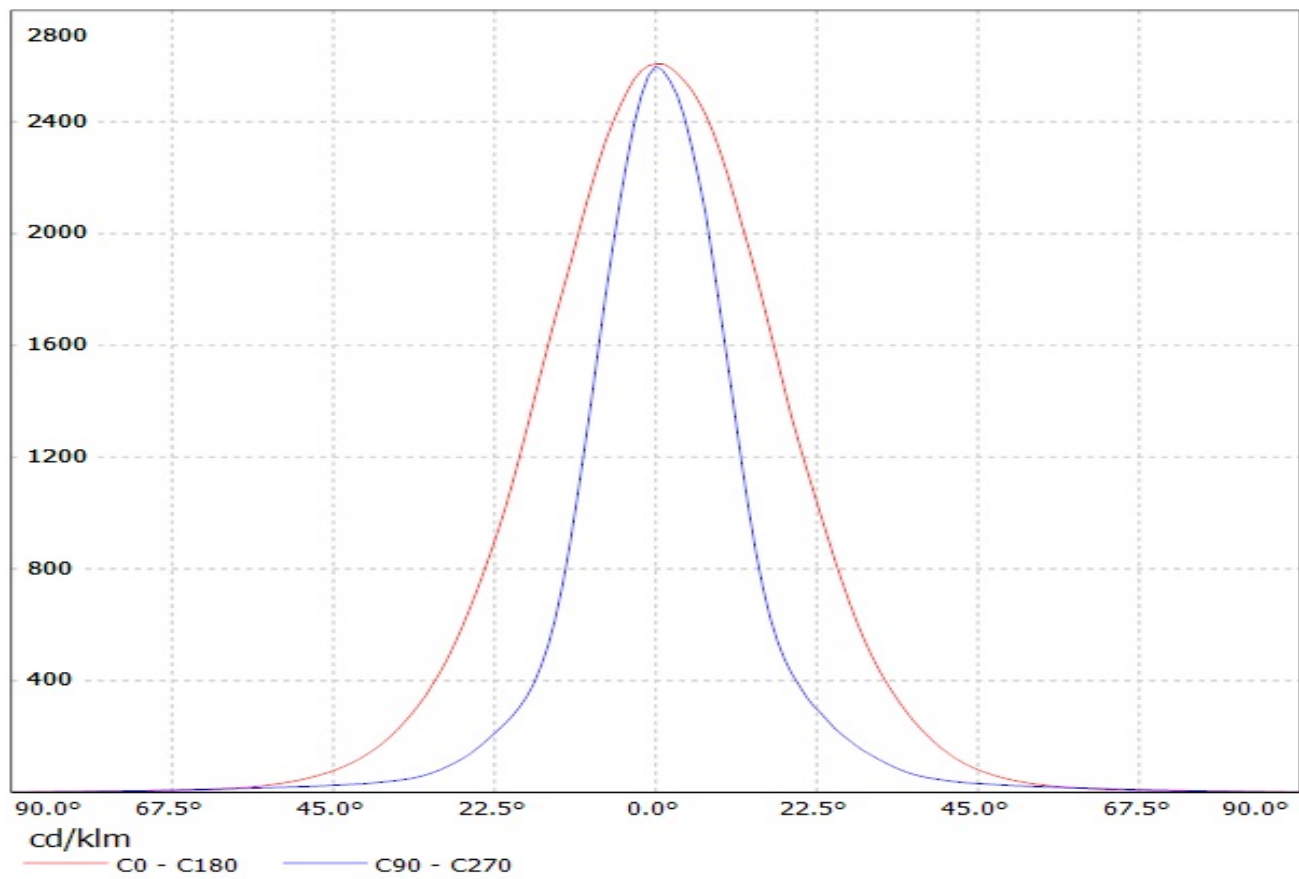



Luminaire: LEDil Oy C12828\_EVA-O\_(Luxeon\_MZ) Efficiency=86%  
Lamps: 1 x Philips Lumileds Luxeon MZ (389lm @ 250mA) CCT=3800K P=2.8W I=250mA

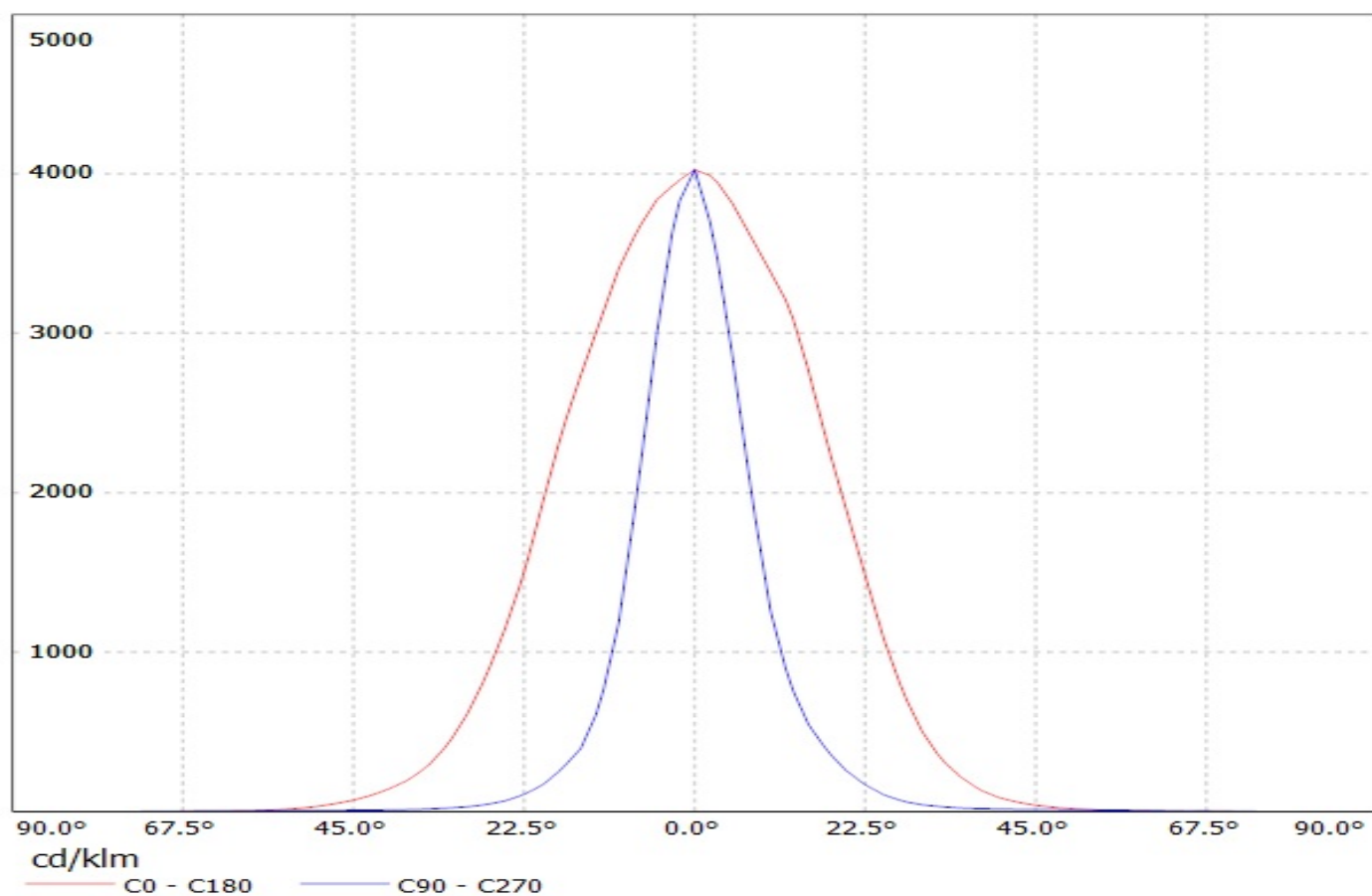

Luminaire: LEDiL Oy C12828\_EVA-O\_(NS9x383) Eff. 87,3%  
Lamps: 1 x Nichia NS9x383 (105lm@250mA)

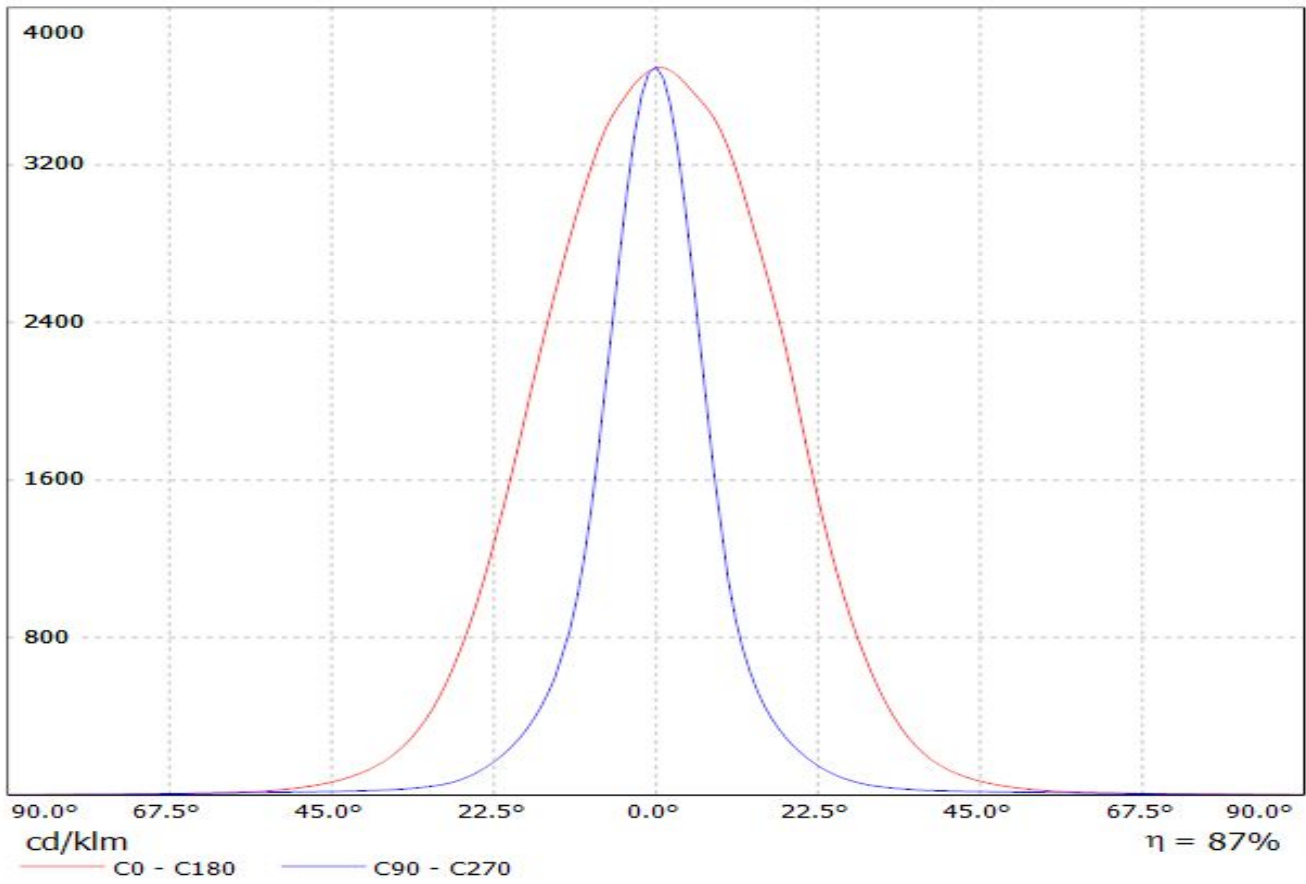

Luminaire: LEDiL Oy C12858\_EVA-O\_(NICHIA\_286) Eff.86%  
Lamps: 1 x NICHIA\_286\_(NSML286ME) 322.274lm@100mA CCT=3000K P=3.42532W I=100.1mA

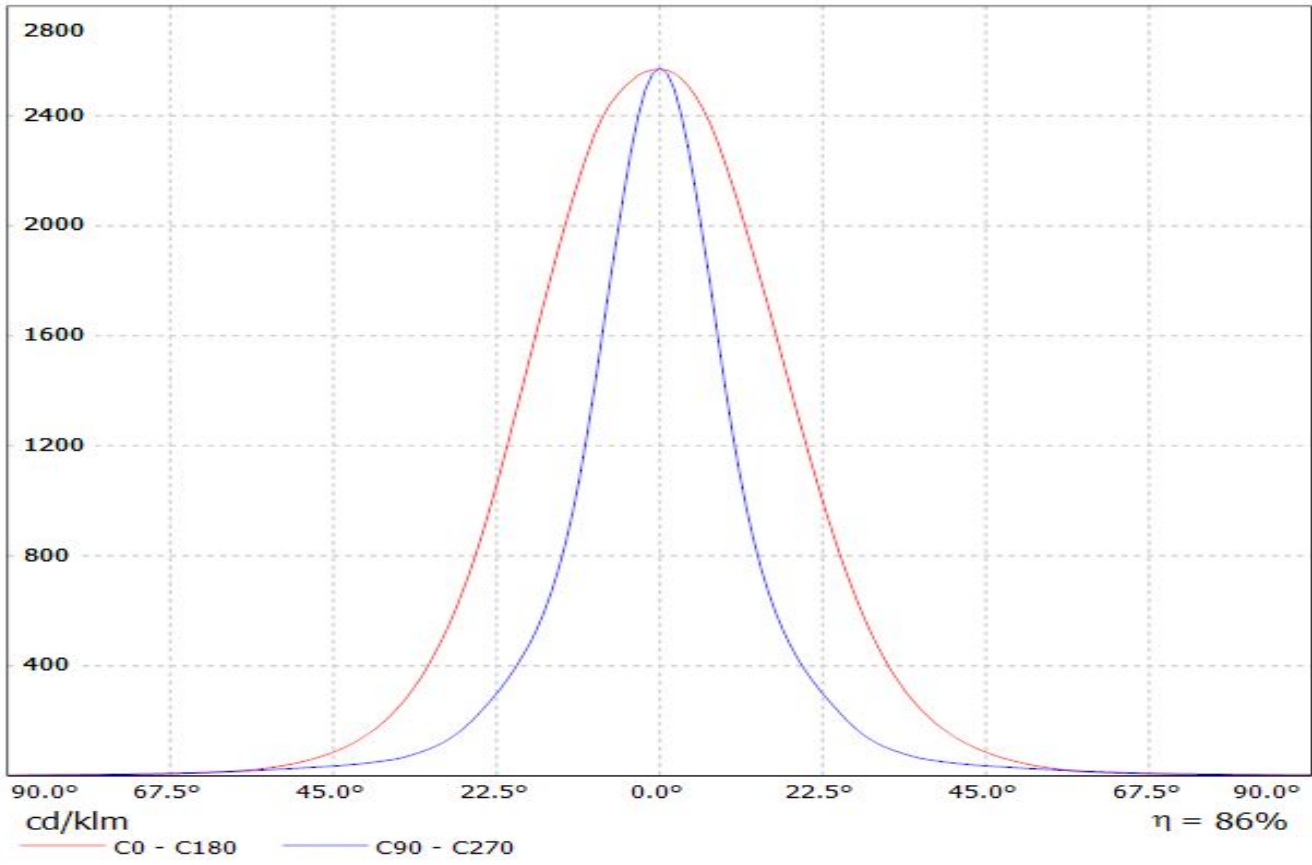

Luminaire: LEDil Oy C12828\_EVA-O\_(DURIS\_S8) Efficiency=88%  
Lamps: 1 x Osram DURIS S8 (GW P9LMS1.ÉC) 192lm @ 100mA CCT=2900K P=1.8W I=100mA

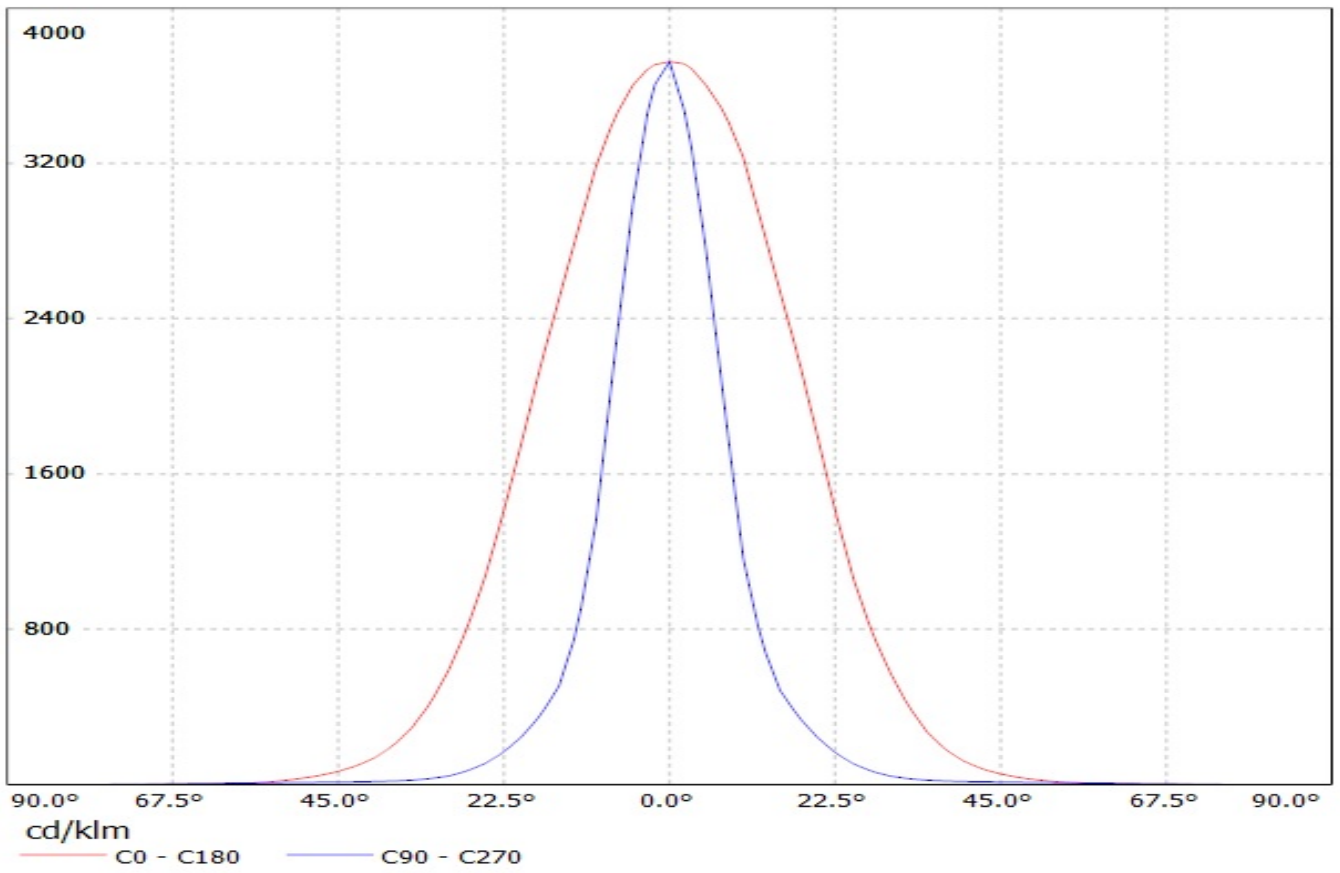

Luminaire: LEDIL OY C12828\_EVA-O (XM-L) Efficiency=86%  
Lamps: 1 x Cree XM-L (111lm @ 250mA)

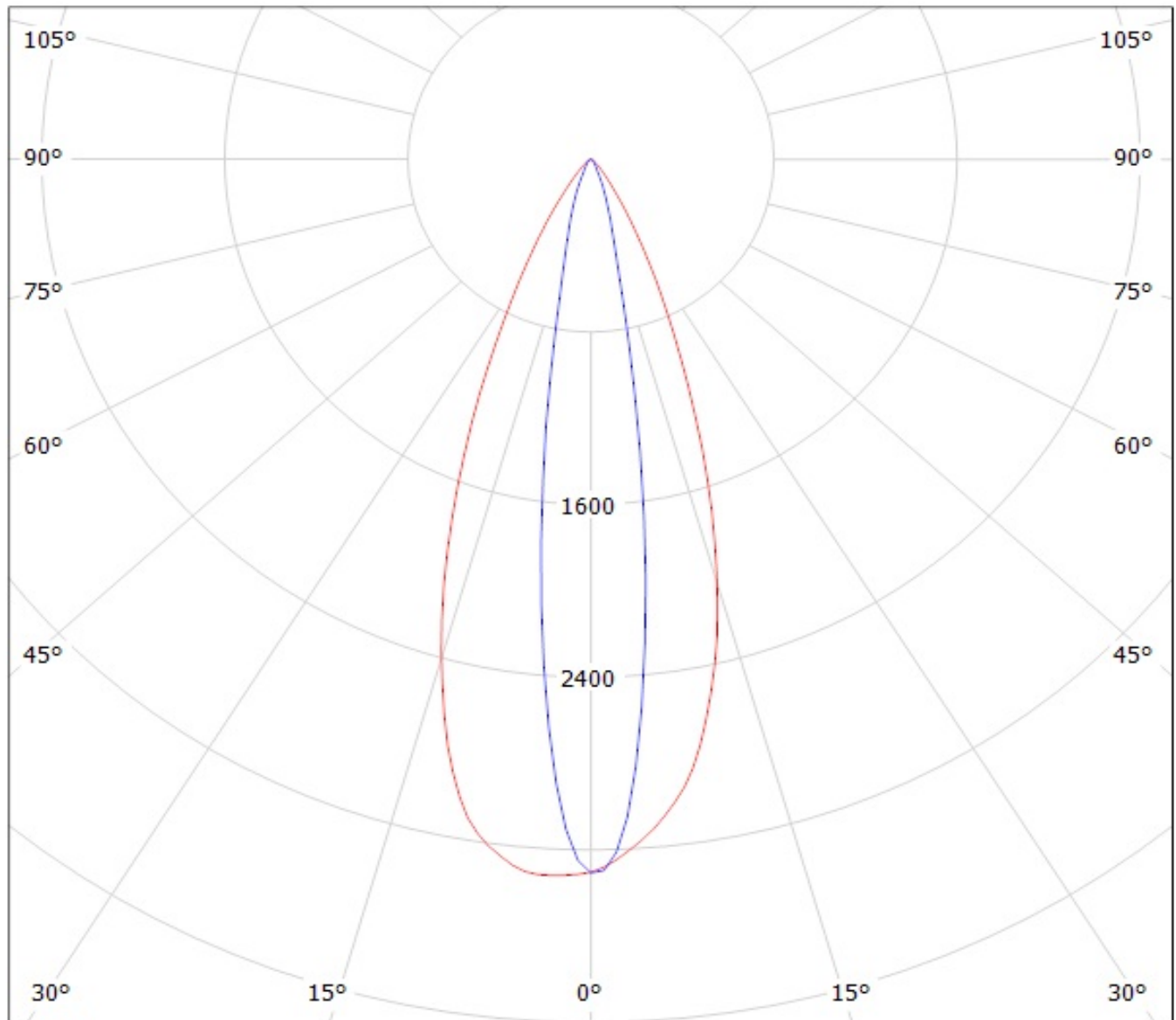

cd/klm

— C0 - C180

— C90 - C270

Luminaire: LEDIL OY C12828\_EVA-O (Luxeon M) Efficiency=83%  
Lamps: 1 x Luxeon M (362lm @ 250mA)

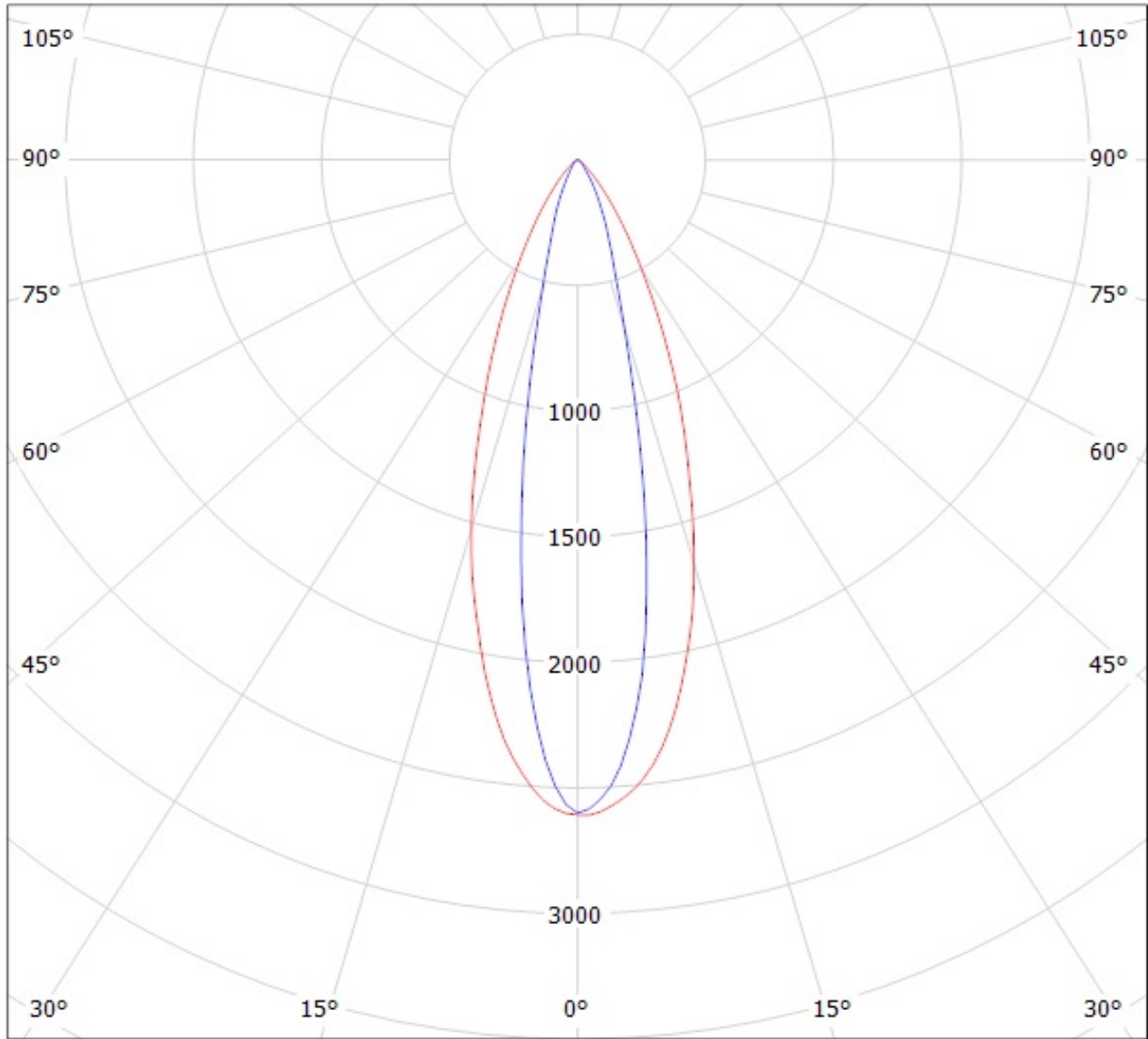

cd/klm

— C0 - C180

— C90 - C270

Luminaire: LEDil Oy C12828\_EVA-O\_(Luxeon\_MZ) Efficiency=86%  
Lamps: 1 x Philips Lumileds Luxeon MZ (389lm @ 250mA) CCT=3800K P=2.8W I=250mA

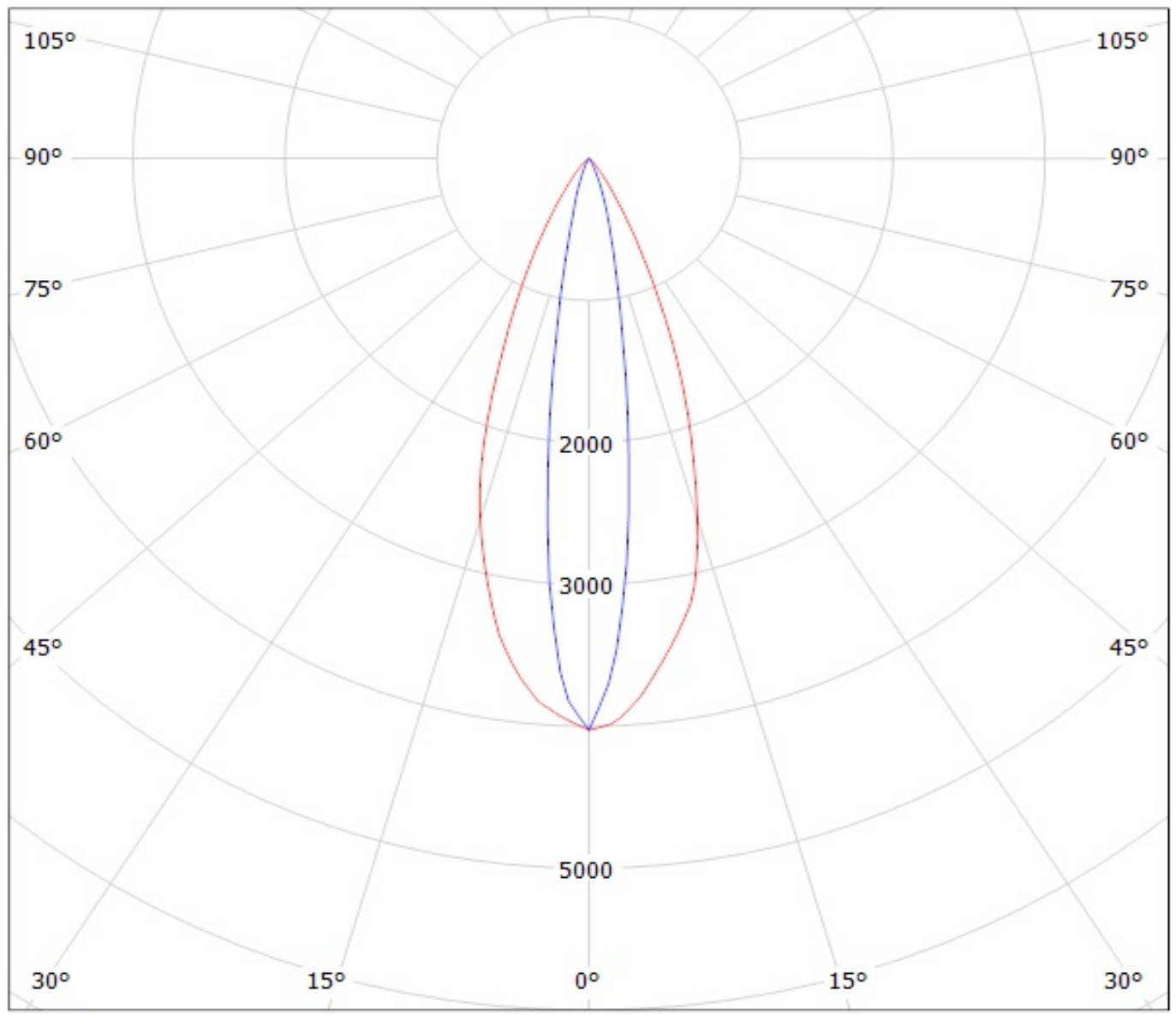

cd/klm  
— C0 - C180    — C90 - C270

Luminaire: LEDiL Oy C12828\_EVA-O\_(NS9x383) Eff. 87,3%  
Lamps: 1 x Nichia NS9x383 (105lm@250mA)

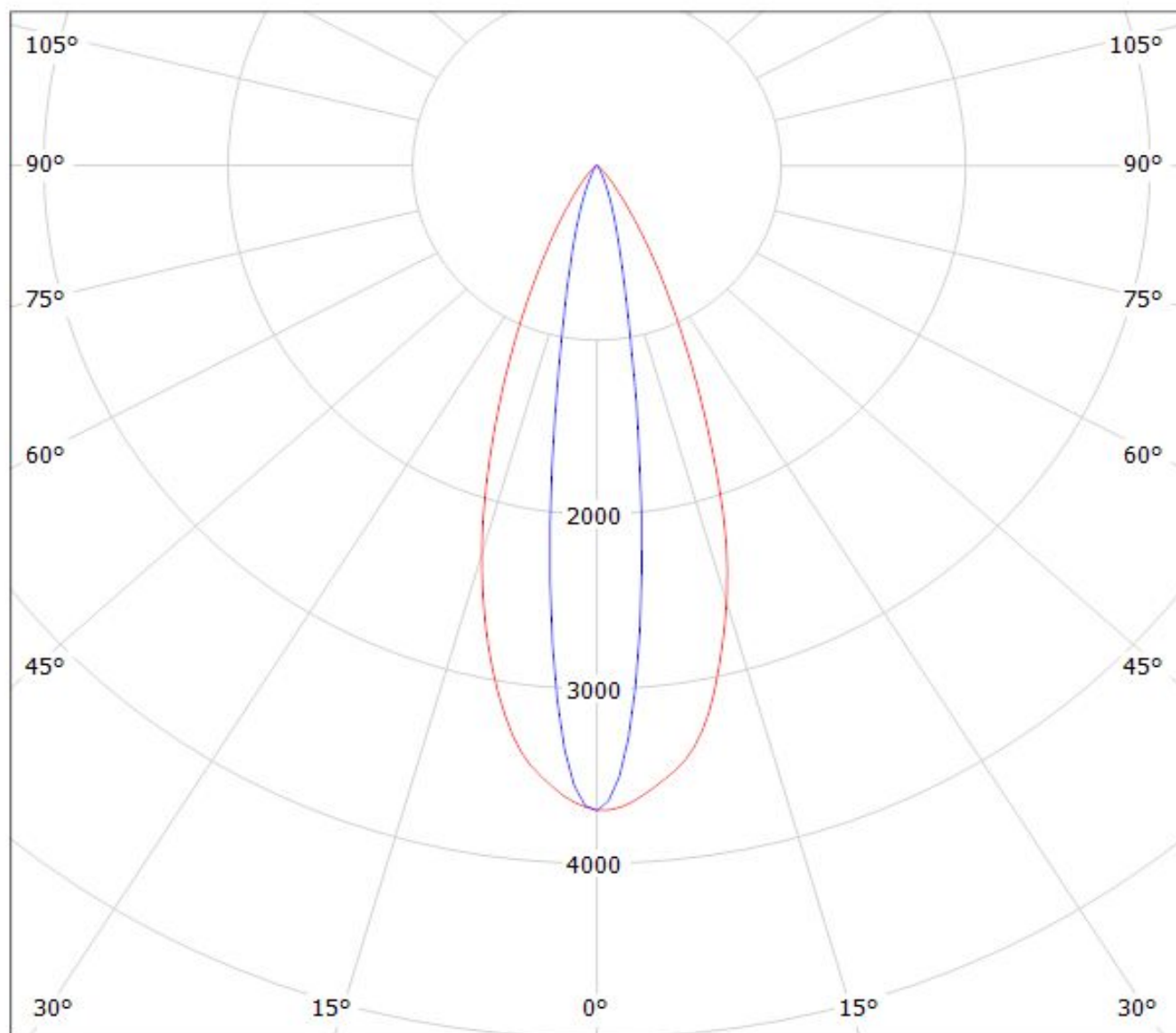

cd/klm

— C0 - C180

— C90 - C270

$\eta = 87\%$



Luminaire: LEDiL Oy C12858\_EVA-O\_(NICHIA\_286) Eff.86%

Lamps: 1 x NICHIA\_286\_(NSML286ME) 322.274lm@100mA CCT=3000K P=3.42532W I=100.1mA

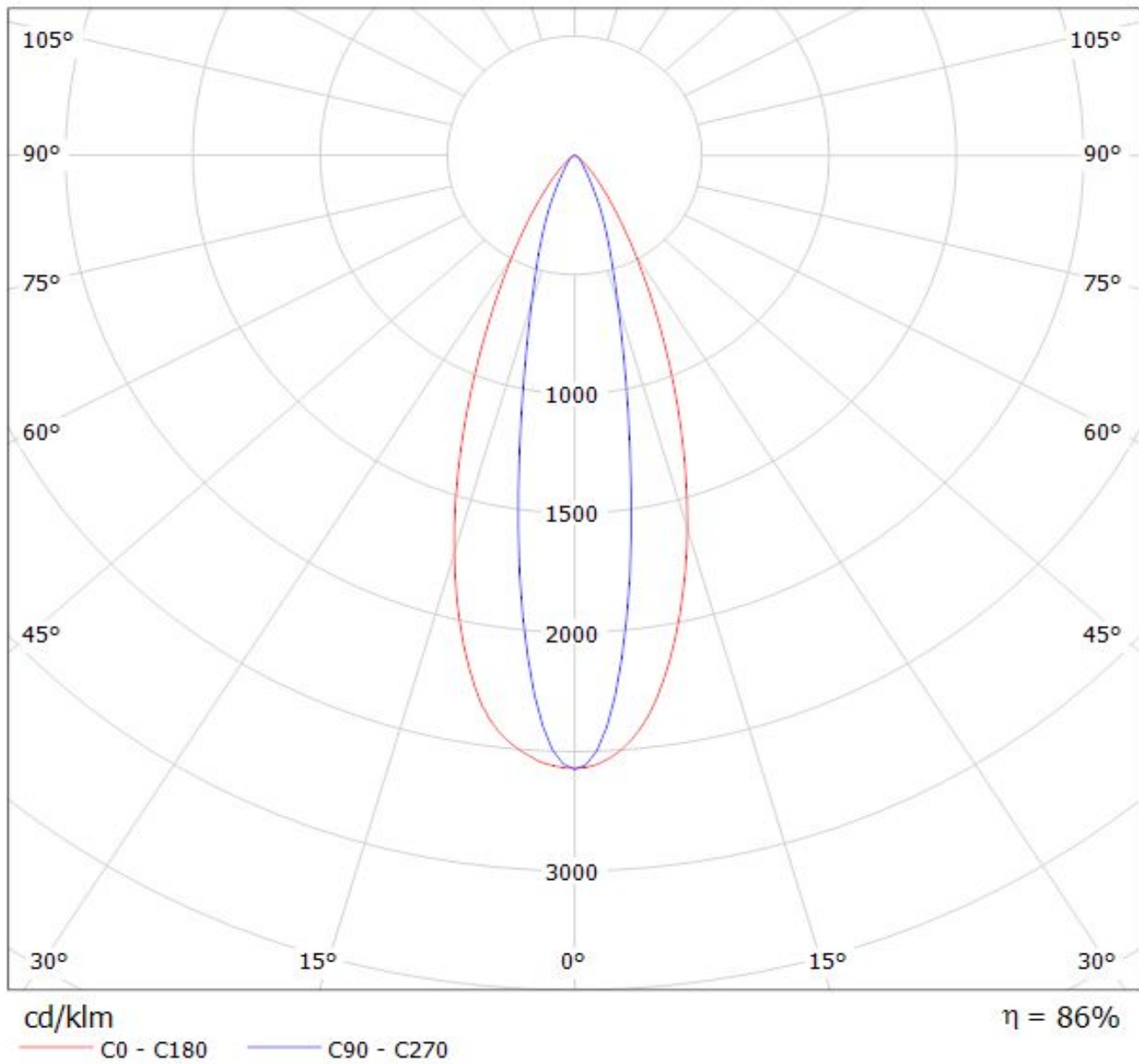

Luminaire: LEDil Oy C12828\_EVA-O\_(DURIS\_S8) Efficiency=88%

Lamps: 1 x Osram DURIS S8 (GW P9LMS1.ĒC) 192lm @ 100mA CCT=2900K P=1.8W I=100mA

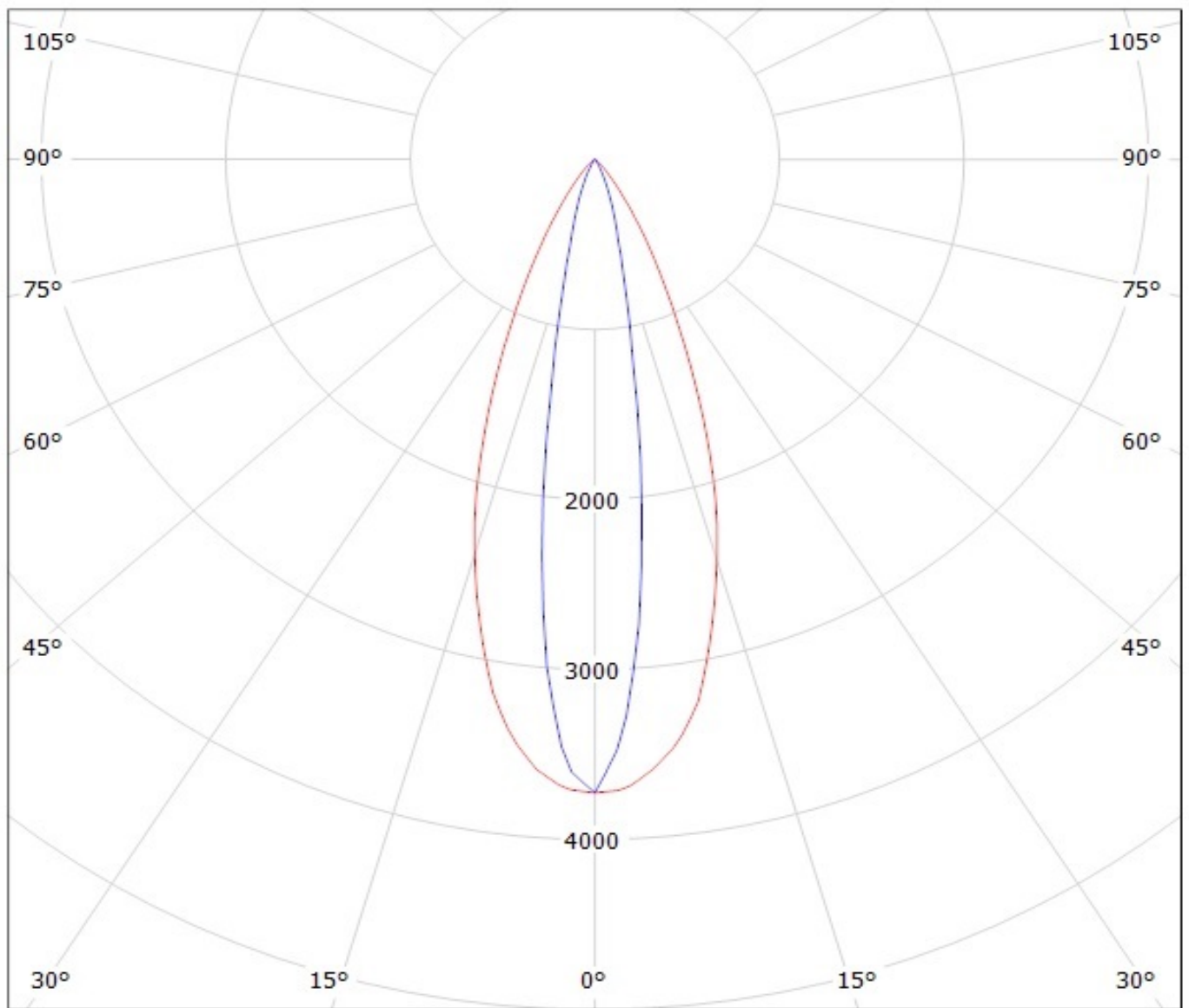

cd/klm

— C0 - C180

— C90 - C270

**NOTE: The typical divergence will be changed by different color, chip size and chip position tolerance. The typical total divergence is the full angle measured where the luminous intensity is half of the peak value.**