

ALF20G222FP400

Aliases (A533JW222M400G)

ALF20, Aluminum Electrolytic, 2,200 uF, 20%, 400 VDC, -40/+85°C

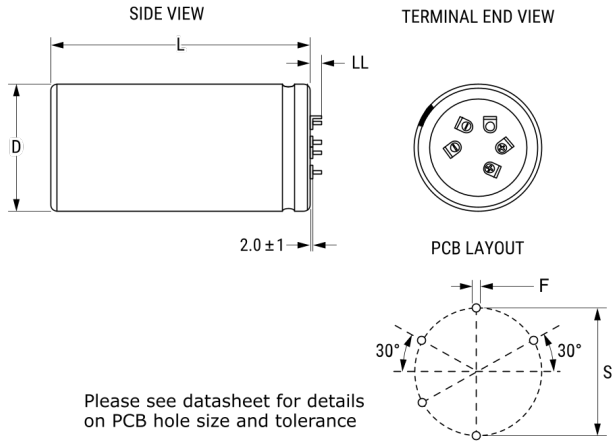

Please see datasheet for details on PCB hole size and tolerance

Click [here](#) for the 3D model.

Dimensions

D	45mm +1mm
L	105mm +/-2mm
S	25mm +/-0.1mm
LL	5.5mm +/-1mm
F	1.486mm +/-0.076mm

Packaging Specifications

Packaging	Bulk
Packaging Quantity	30

General Information

Series	ALF20
Dielectric	Aluminum Electrolytic
Style	Press-Fit
Description	Press-Fit, Aluminum Electrolytic
RoHS	Yes
Lead	5 Pin Press-Fit
AEC-Q200	No
Component Weight	215 g
Notes	Dimensions Include Slewing.
Shelf Life	156 Weeks

Specifications

Capacitance	2,200 uF
Capacitance Tolerance	20%
Voltage DC	400 VDC, 440 VDC (Surge)
Temperature Range	-40/+85°C
Rated Temperature	85°C
Life	18000 Hrs (Rated Voltage and Ripple Current at 85C), 29000 Hrs (Rated Voltage at 85C)
Resistance	77 mOhms (100Hz 20C), 53 mOhms (10kHz 20C)
Ripple Current	6.56 Amps (100Hz 85C), 10.9 Amps (10kHz 85C)
Leakage Current	5280 uA (5min 20°C)