

DETAILS

Product Number	FN13323_STELLA-A
Family	STELLA
Type	Pack
Color	black
Diameter	90 mm
Height	22 mm
Style	round
Optic Material	Silicone
Holder Material	
Fastening	screw
Status	production ready
ROHS Compliant	Yes
Date Updated	26/09/2016



OPTICAL PROPERTIES

LED	Viewing Angle	Light Beam	Efficiency	cd/lm	Connector
VERO13	Asymmetric deg	Asymmetric	92 %	0.660	-
VERO18	Asymmetric deg	Asymmetric	92 %	0.500	-
V15 Gen6	Asymmetric deg	Asymmetric	91 %	0.550	-
V10 Gen7	sim: Asymmetric	Asymmetric	sim: 89 %	sim: 0.560	Bender Wirth: 434 Typ L1
V13 Gen7	sim: Asymmetric	Asymmetric	sim: 89 %	sim: 0.550	Bender Wirth: 477 Typ L1
V18 Gen7	sim: Asymmetric	Asymmetric	sim: 88 %	sim: 0.380	-
CLL03x/CLU03x	Asymmetric deg	Asymmetric	92 %	0.616	Bender Wirth: 433 Typ L1
CLU710/711	Asymmetric deg	Asymmetric	89 %	0.960	-
CLU720/721	asymmetric deg	Asymmetric	sim: 90 %	0.730	-
CLU730/731	sim: Asymmetric	Asymmetric	sim: 90 %	-	-
CLU700/701	Asymmetric deg	Asymmetric	89 %	1.400	Bender Wirth: 434 Typ L1
CLU720/721	Asymmetric deg	Asymmetric	91 %	0.760	Bender Wirth: 433 Typ L1
CLL02x/CLU02x (LES10)	sim: Asymmetric	Asymmetric	sim: 91 %	sim: 0.730	-
CLL03x/CLU03x	sim: Asymmetric	Asymmetric	sim: 90 %	sim: 0.490	-
CXA/B 25xx	Asymmetric deg	Asymmetric	93 %	0.490	-
CXA/B 15xx	Asymmetric deg	Asymmetric	92 %	1.100	-
CXA/B 1816 & CXA/B 1820 & CXA 1850 asymmetric	deg	Asymmetric	87 %	0.670	-
CXA/B 1816 & CXA/B 1820 & CXA 1850 asymmetric	deg	Asymmetric	89 %	0.670	Bender Wirth: 437 Typ L1
CXA/B 15xx	Asymmetric deg	Asymmetric	92 %	0.850	Bender Wirth: 441 Typ L1
LUXEON CoB 1208	Asymmetric deg	Asymmetric	-	0.300	-
LUXEON CoB 1202/1203	asymmetric deg	Asymmetric	88 %	0.910	Bender Wirth: 438 Typ L1
CXM-18	Asymmetric deg	Asymmetric	89 %	0.460	-
CXM-14	asymmetric deg	Asymmetric	90 %	0.580	-
COB L-Type (LES 9)	Asymmetric deg	Asymmetric	90 %	0.930	Bender Wirth: 438 Typ L1
COB L-Type (LES 11)	Asymmetric deg	Asymmetric	89 %	0.720	Bender Wirth: 438 Typ L1



PRODUCT DATASHEET

STELLA series

last update 26/9/2016

OPTICAL PROPERTIES

LED	Viewing Angle	Light Beam	Efficiency	cd/lm	Connector
Soleriq S19	Asymmetric deg	Asymmetric	90 %	0.500	-
Soleriq S13	Asymmetric deg	Asymmetric	91 %	0.700	-
Soleriq P13	asymmetric deg	Asymmetric	90 %	0.610	-
Soleriq P13	Asymmetric deg	Asymmetric	94 %	0.660	Bender Wirth: 437 Typ L1
Soleriq S13	Asymmetric deg	Asymmetric	92 %	0.690	Bender Wirth: 437 Typ L1
Soleriq P9	asymmetric deg	Asymmetric	88 %	0.900	Bender Wirth: 461 Typ L1
Mega Zenigata (GW6DME)	asymmetric deg	Asymmetric	90 %	0.570	-
SLE G5 LES15	Asymmetric deg	Asymmetric	86 %	0.600	-

H G F E D C B A

NOTE: Maximum recommended tightening torque for STELLA-FRAME is 0,4Nm

Front view

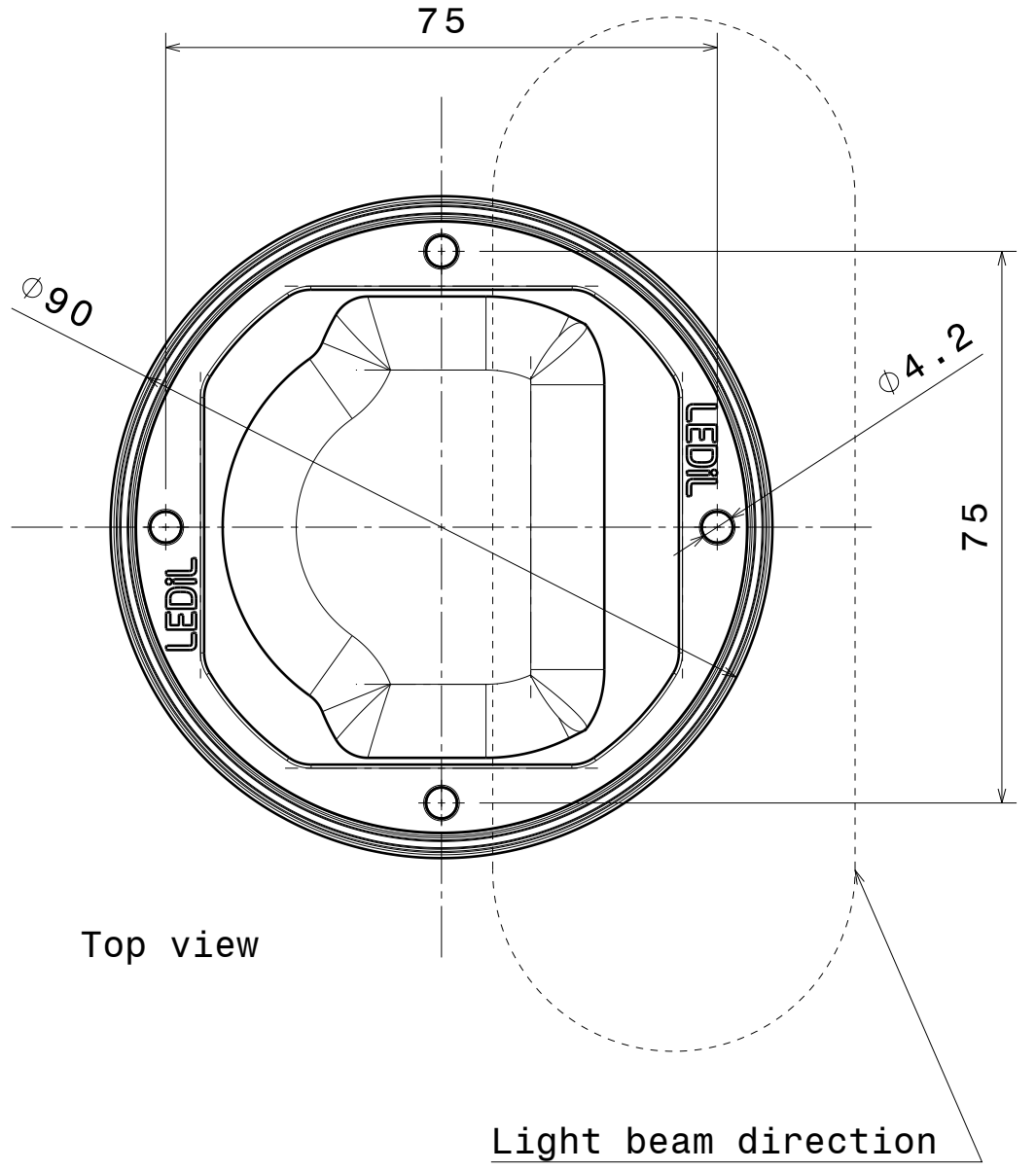
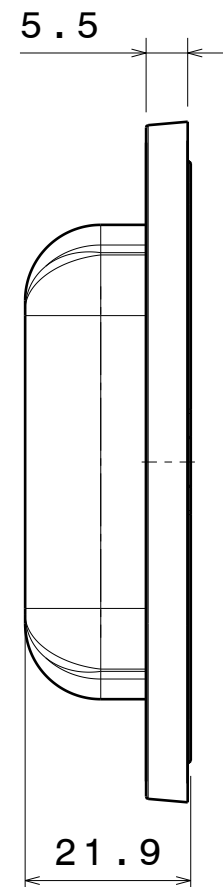
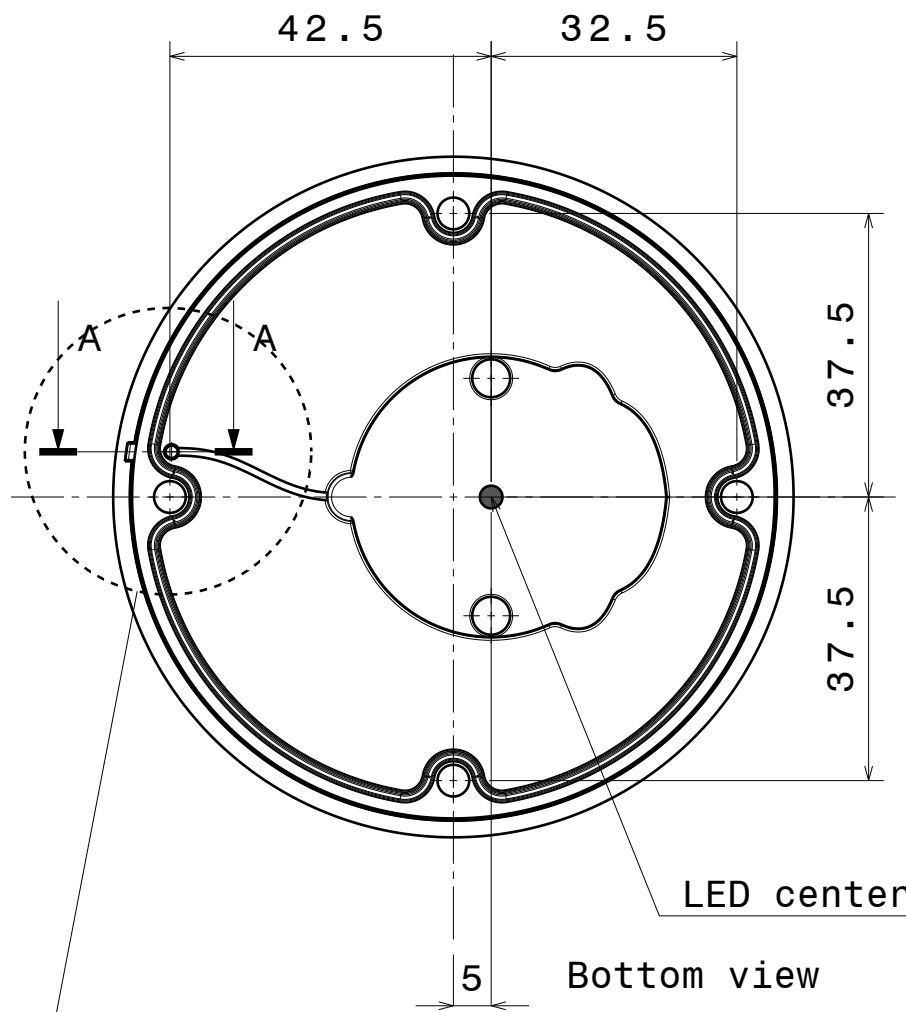

Bottom view

Top view

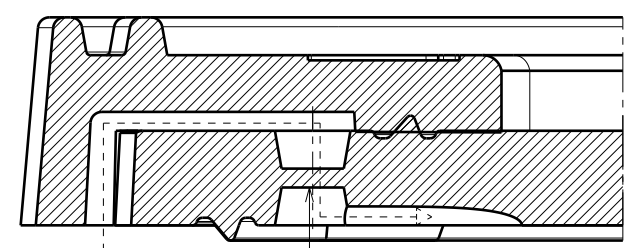

Section view A-A
Scale: 5:1



Isometric view

Venting pipe:
Piercing this membrane
will Allow lens breathing

Lens material: Optical grade LSR
Frame material: PA, black

Tolerances if not otherwise shown
According to DIN ISO 2768-1
Linear measures: class V
Please note that due to the elasticity of
products made of silicone actual measured
values may vary, and therefore typical
tolerance values may not be applied.

LEDiL Ledil Oy
Salorankatu 10
FIN 24240 SALO
Finland

THIRD ANGLE PROJECTION:

DRAWING TITLE
STELLA-A datasheet

This drawing is the property
of LEDiL Oy. It may not be
reproduced, copied or
communicated without a written
agreement with LEDiL Oy."

SIZE	PART NUMBER		
A3	FN13323		

SCALE	1:1	WEIGHT	(g)	SHEET	1/1
-------	-----	--------	-----	-------	-----

H G B A

Luminaire: LEDiL Oy FN13323_STELLA-A Eff. 92%
Lamps: 1 x VERO13 (BXRC-30E4000F) 819lm@250mA CCT=3000K P=7.5W I=250mA

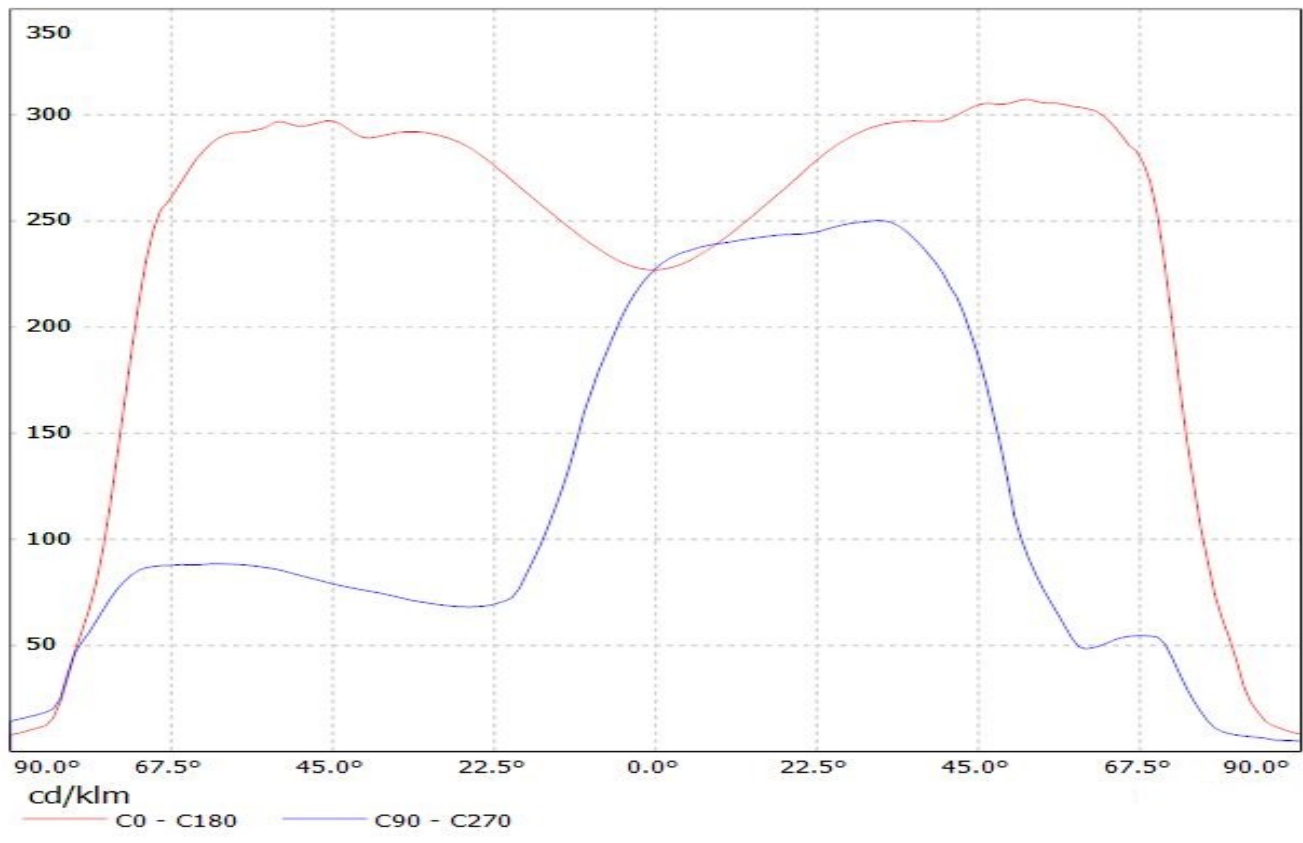

Luminaire: LEDiL Oy FN13323_STELLA-A (VERO18) Eff. 92%
Lamps: 1 x VERO18 (BXRC-30E4000F)786lm@250mA CCT=3000K P=6.84W I=250mA

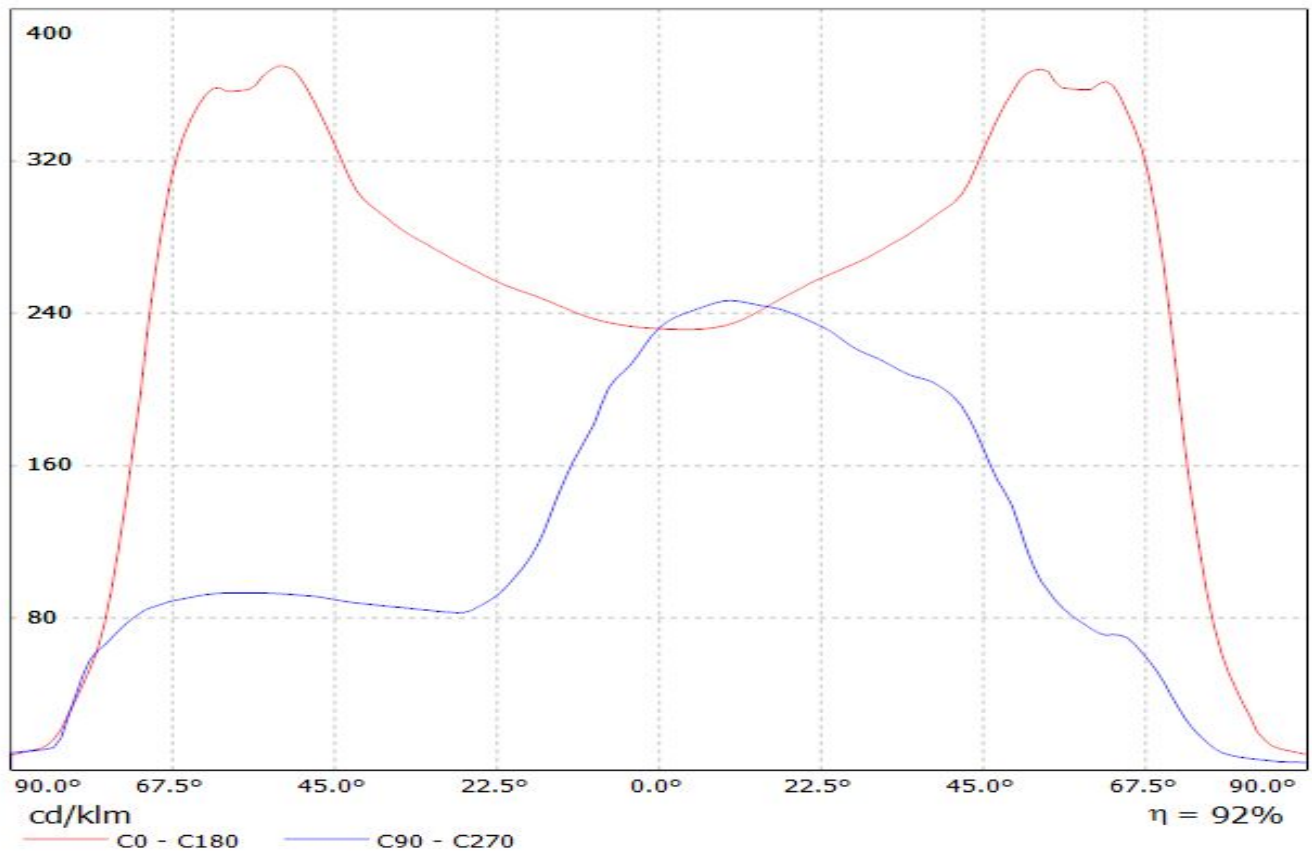

Luminaire: LEDiL Oy FN13323_STELLA-A_(V15)

Lamps: 1 x Bridgelux_V15_1050.21lm@250mA_P=8.19169W_I=249.8mA

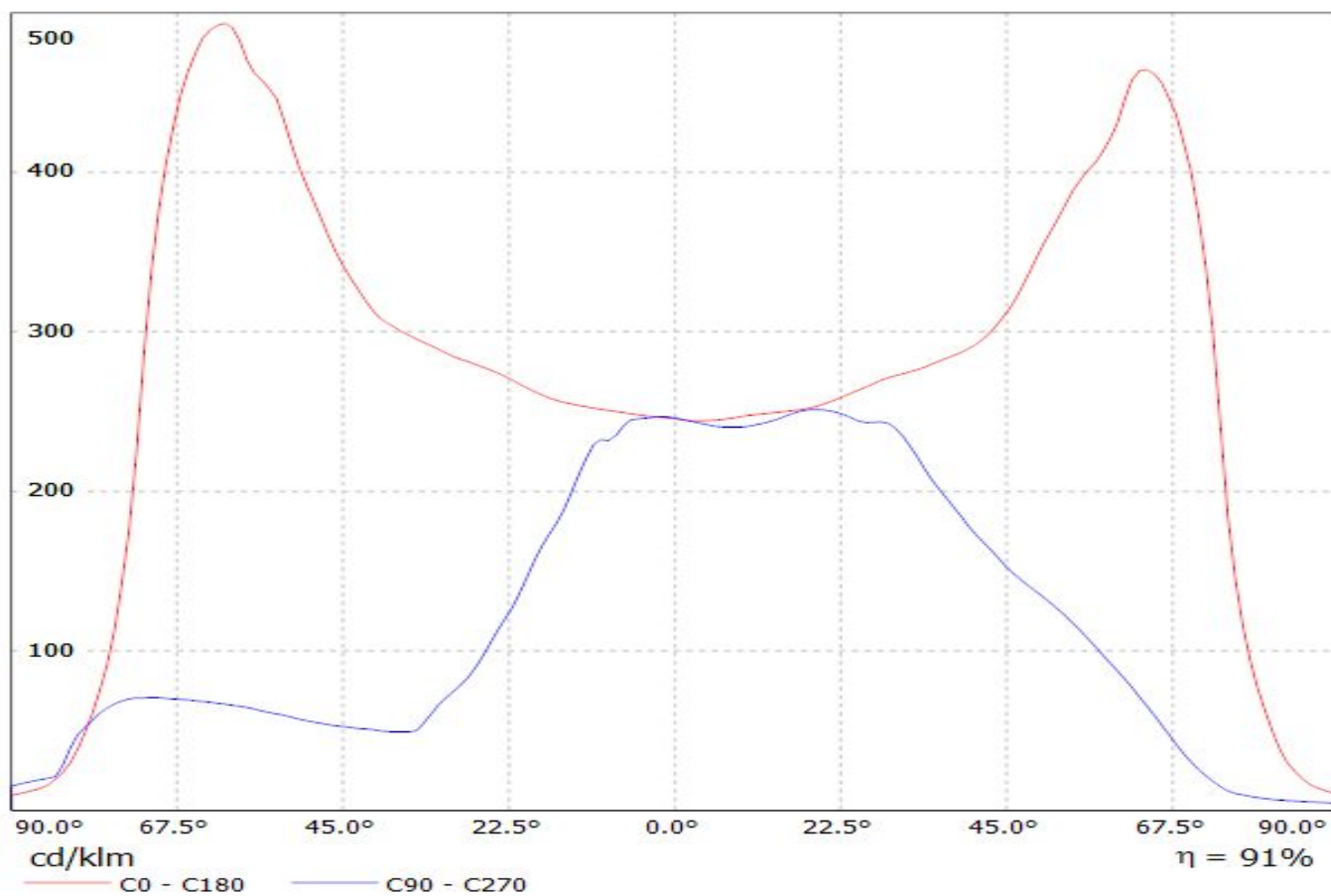

Luminaire: Ledil Oy FN13323_STELLA-A+_Bender+Wirth 434 Typ L1_BRIDGELUX_V10_Gen7_SIMULATED
Lamps: 1 x BRIDGELUX V10 Gen7

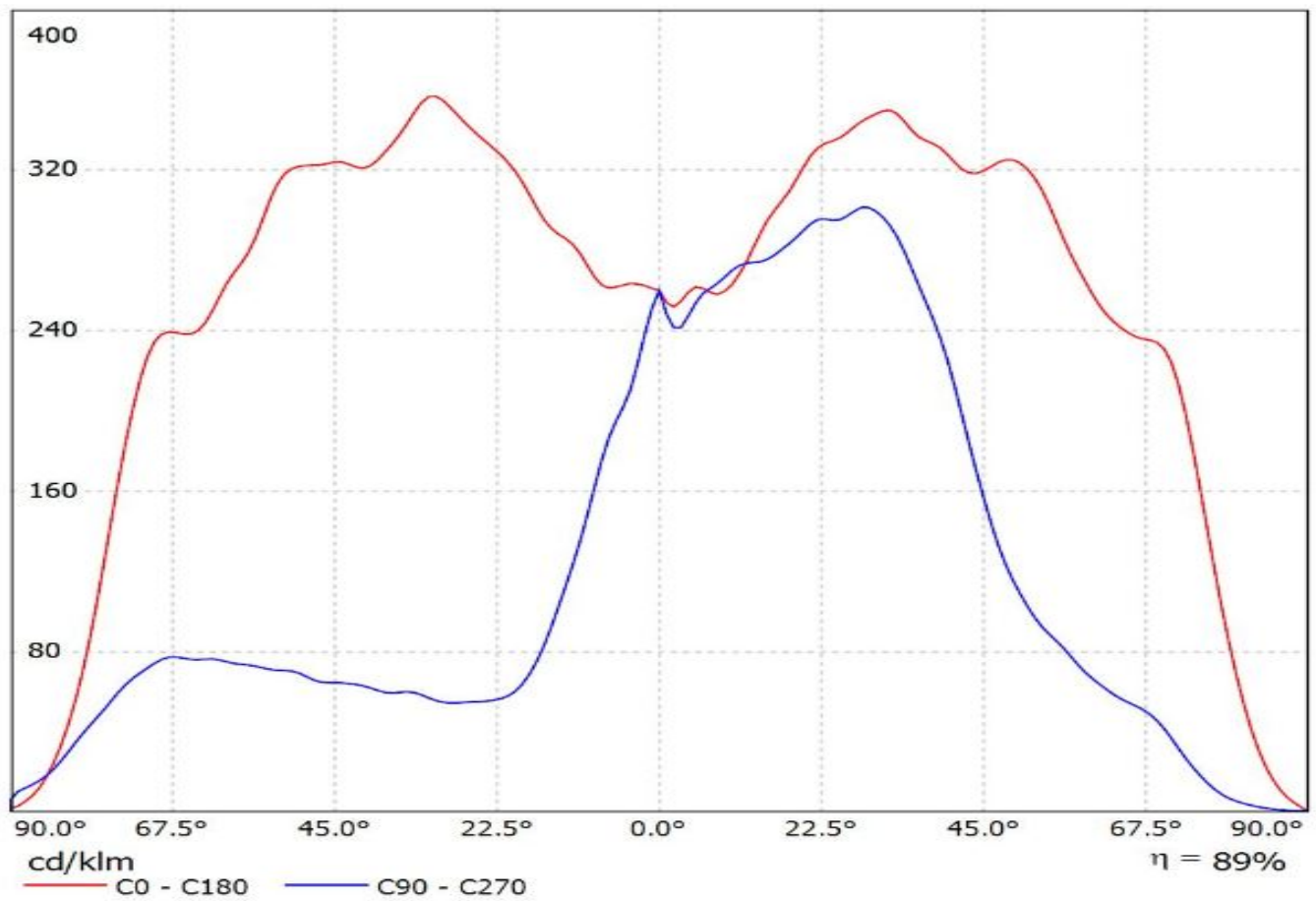

Luminaire: Ledil Oy FN13323_STELLA-A+_B+W 433 TypL1_BRIDGELUX_V13_Gen7_SIMULATED
Lamps: 1 x BRIDGELUX V13 Gen7

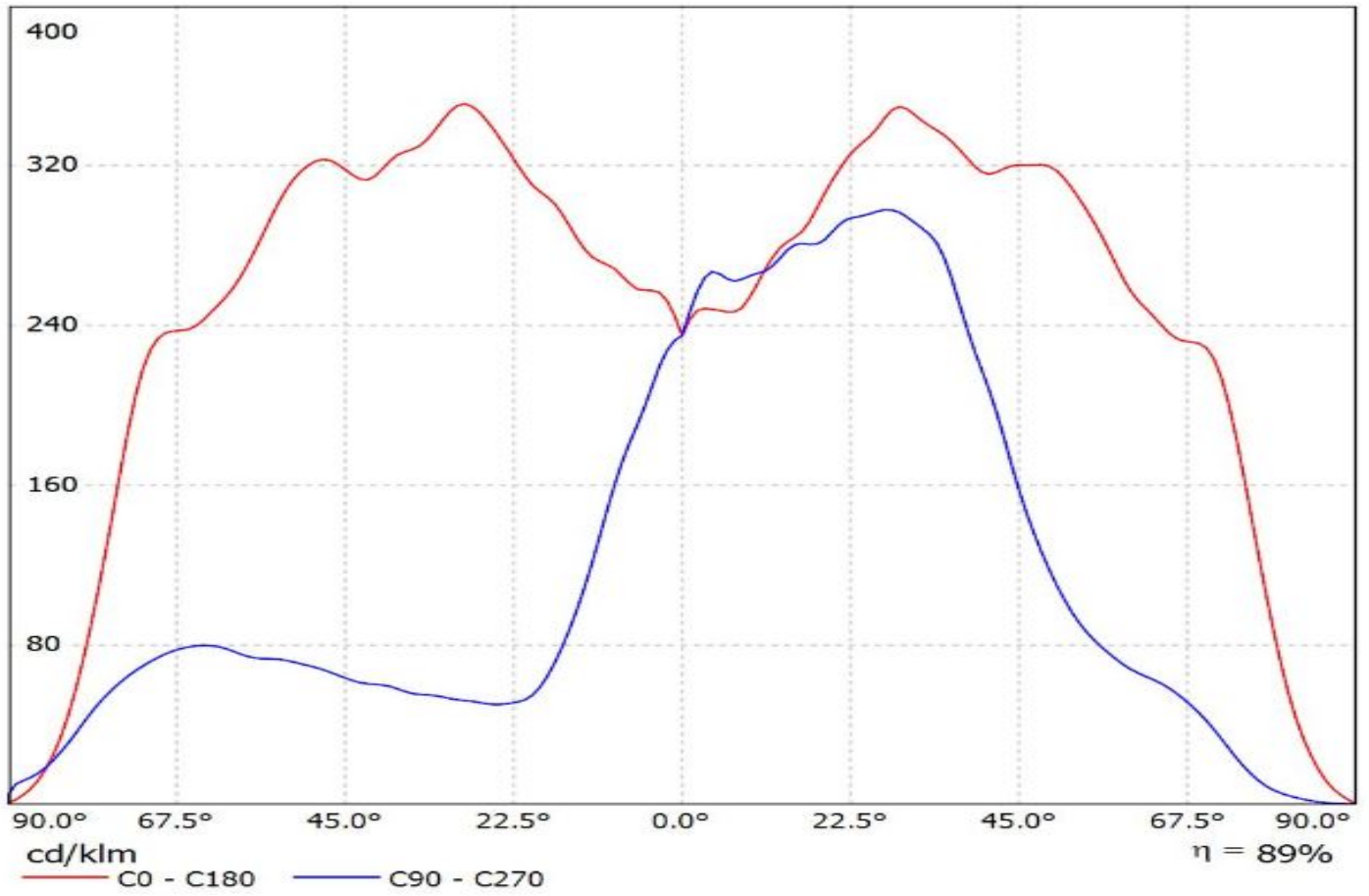

Luminaire: Ledil Oy FN13323_STELLA-A_BRIDGELUX_V18_Gen7_SIMULATED
Lamps: 1 x BRIDGELUX V18 Gen7

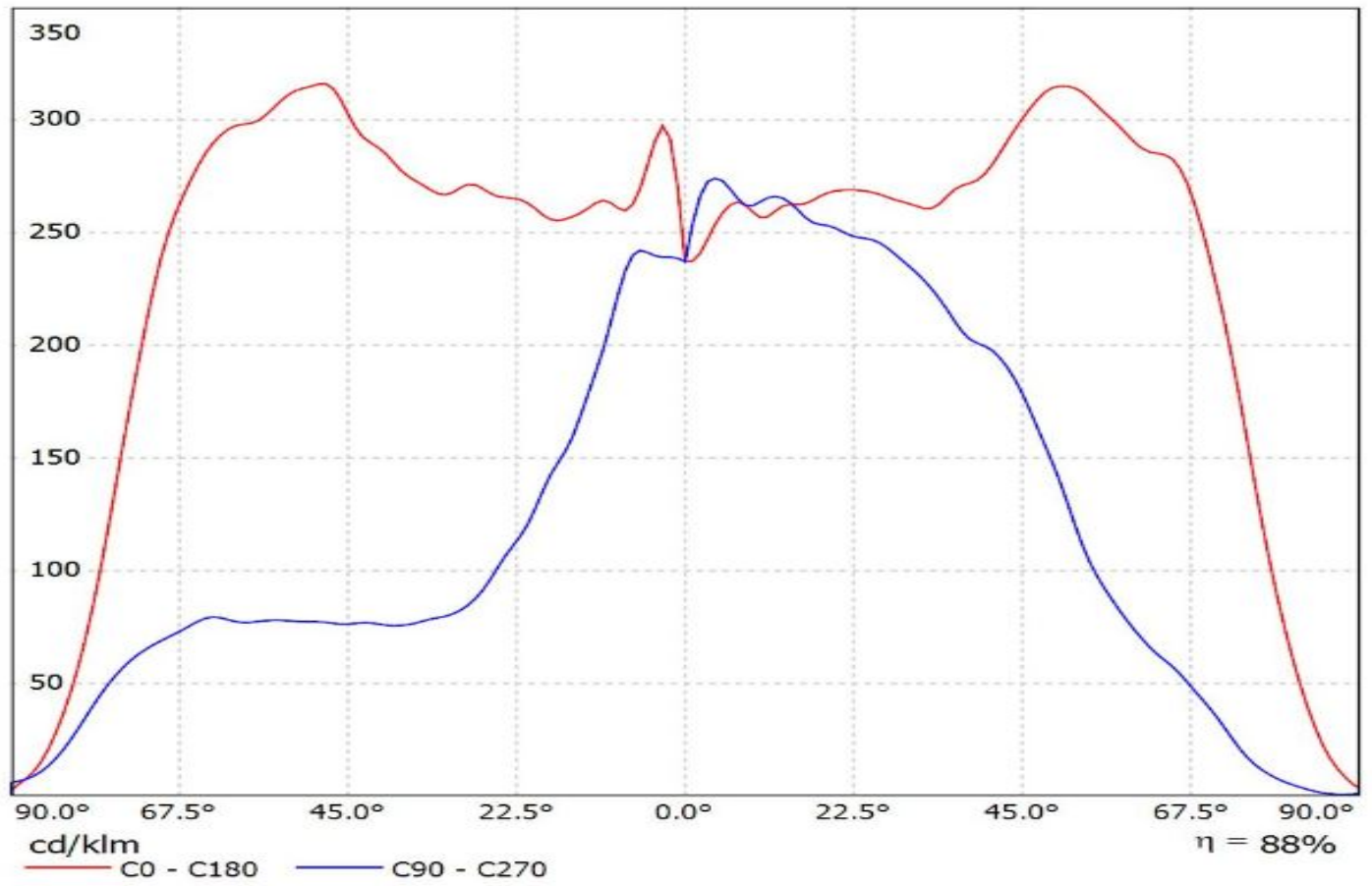

Luminaire: LEDiL Oy FN13323_STELLA-A_(CLL030) Eff. 92%
Lamps: 1 x Citizen_CLL030_(CLL030-1205A5-303H1A7) 690lm@250mA CCT=3000K P=9W I=250mA

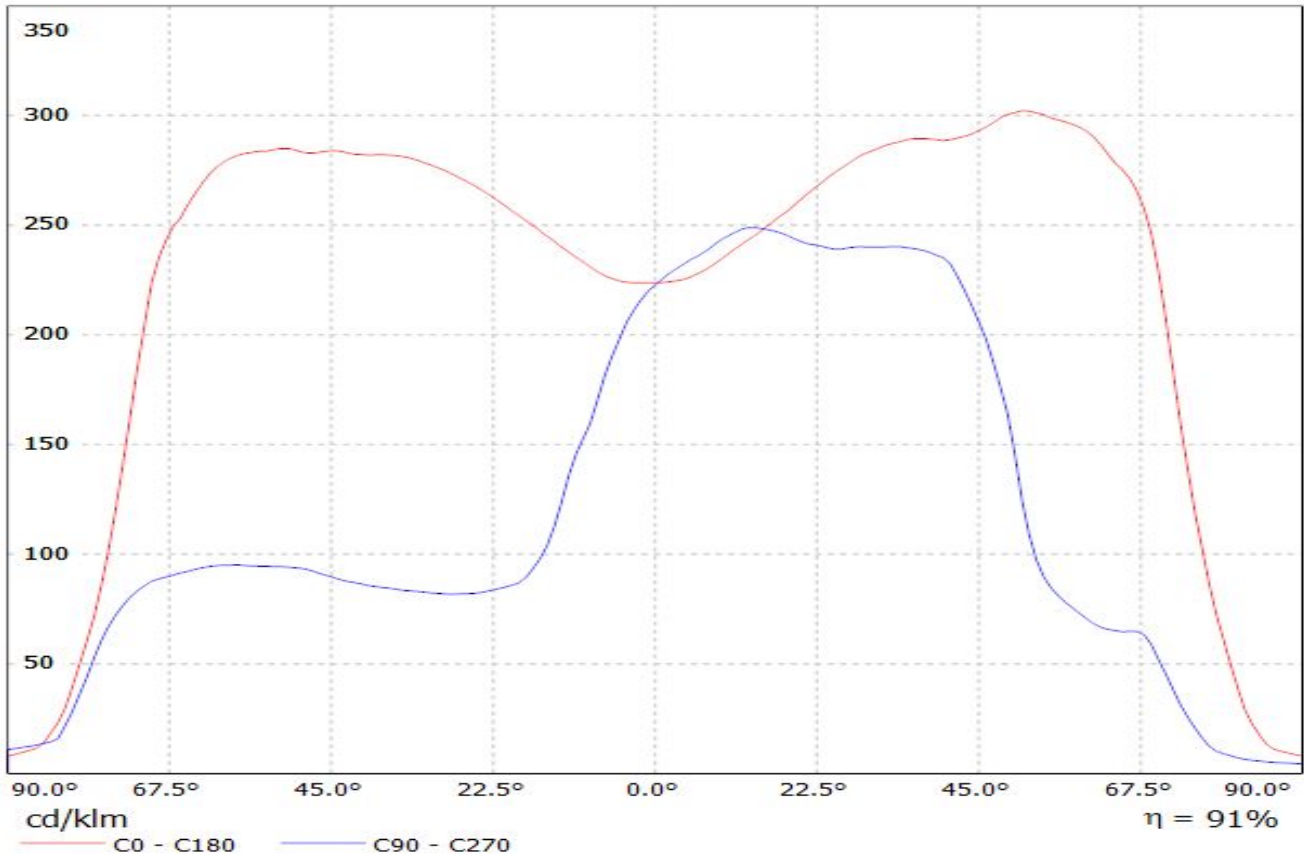

Luminaire: Ledil FN13323_STELLA-A_(CLU710)

Lamps: 1 x CITIZEN_CLU710_(CLU710-1204B8-273M2G1)_1212.66lm@250mA_P=8.5W_I=0.25A

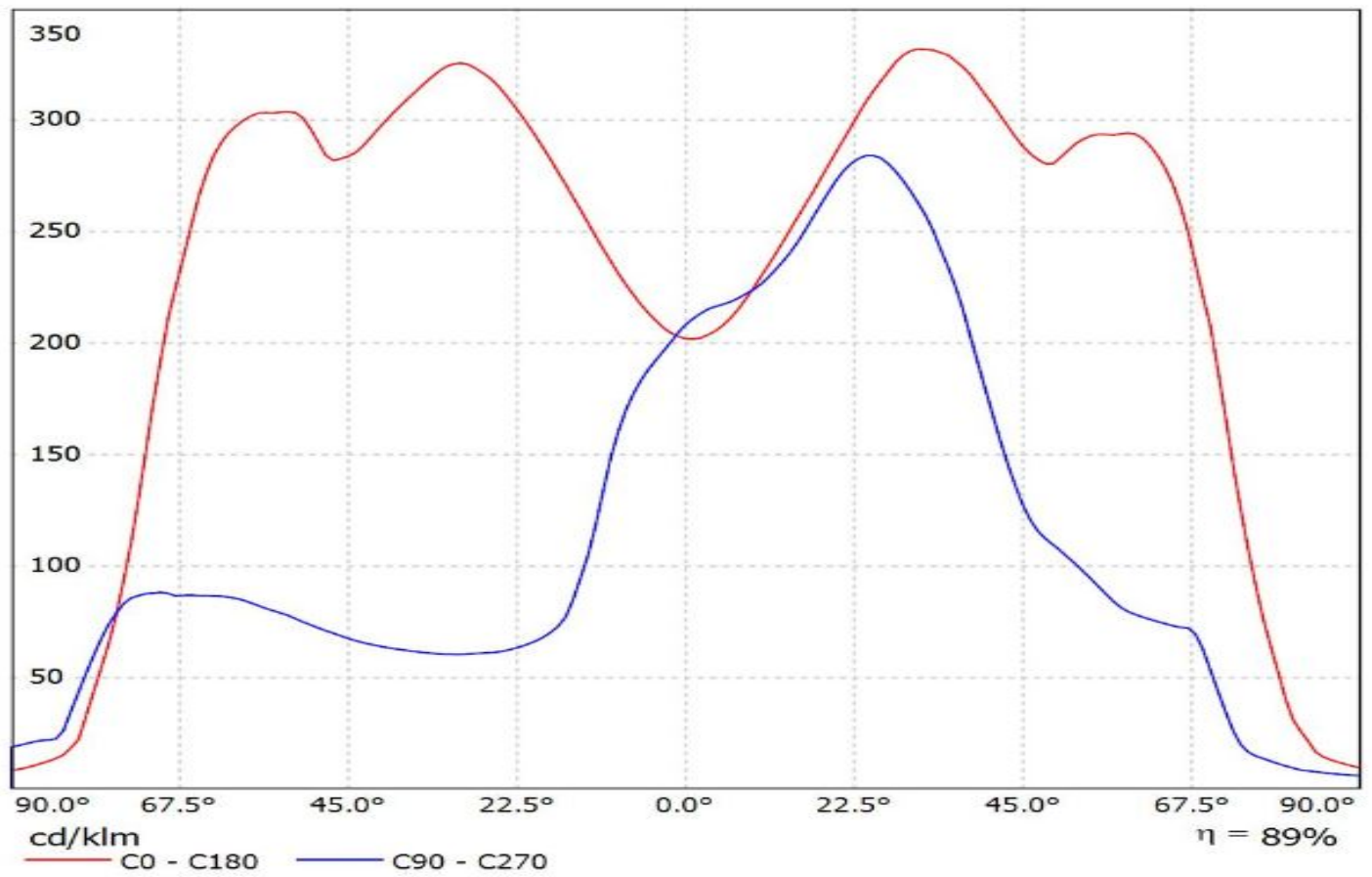

Ledil FN13323_STELLA-A_(CLU720) / LDC (Linear)

Luminaire: Ledil FN13323_STELLA-A_(CLU720)
Lamps: 1 x CITIZEN_CLU720_(CLU720-1206B8-273M2)
_1298.17lm@250mA_CCT=2700K_P=8.3W_I=0.25A

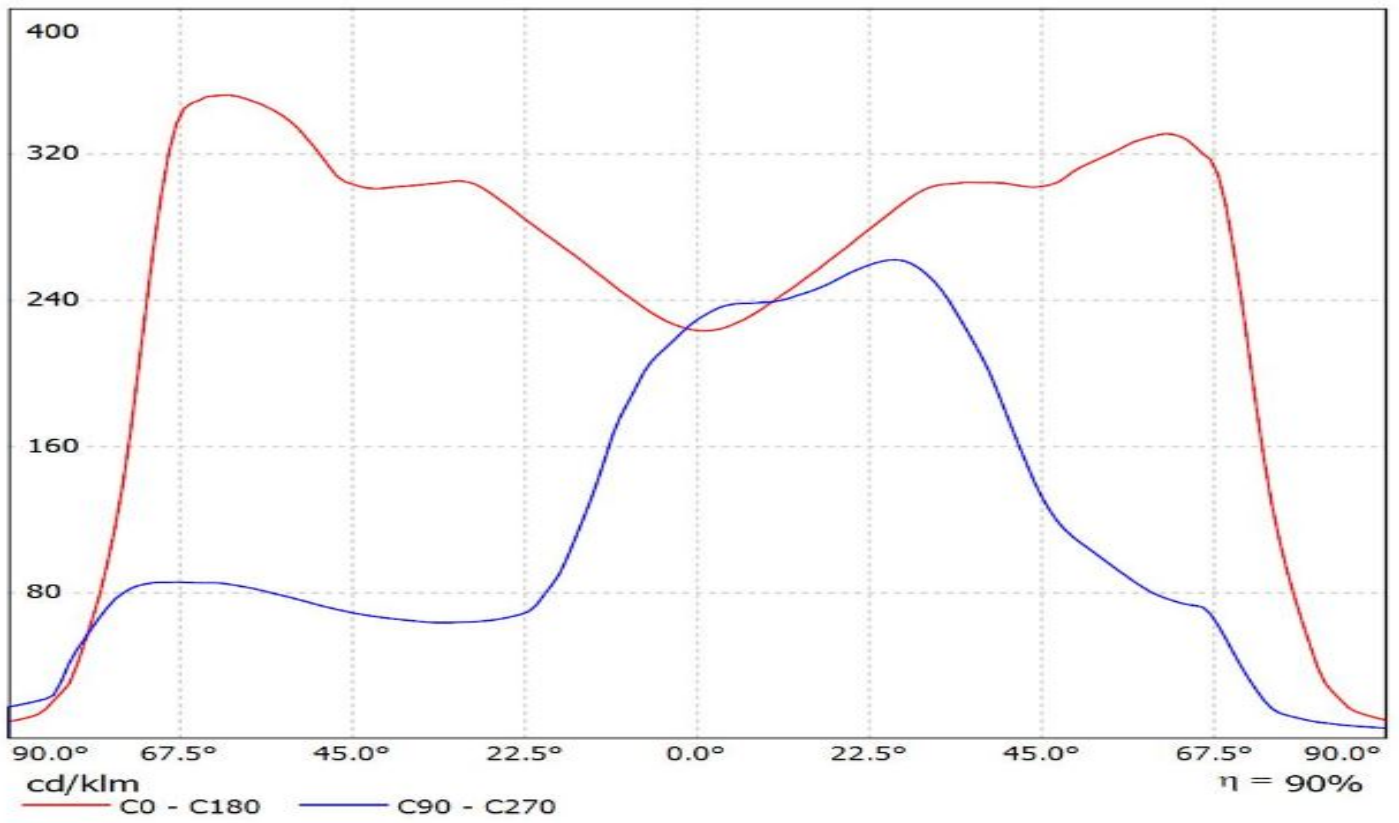

Luminaire: Ledil FN13323_STELLA-A_(CLU700)_(434_Typ_L1)

Lamps: 1 x Citizen_CLU700_(CLU700-1002B8-273M2G1)_(434_Typ_L1)_390.128lm@100mA_P=3W_I=0.10A

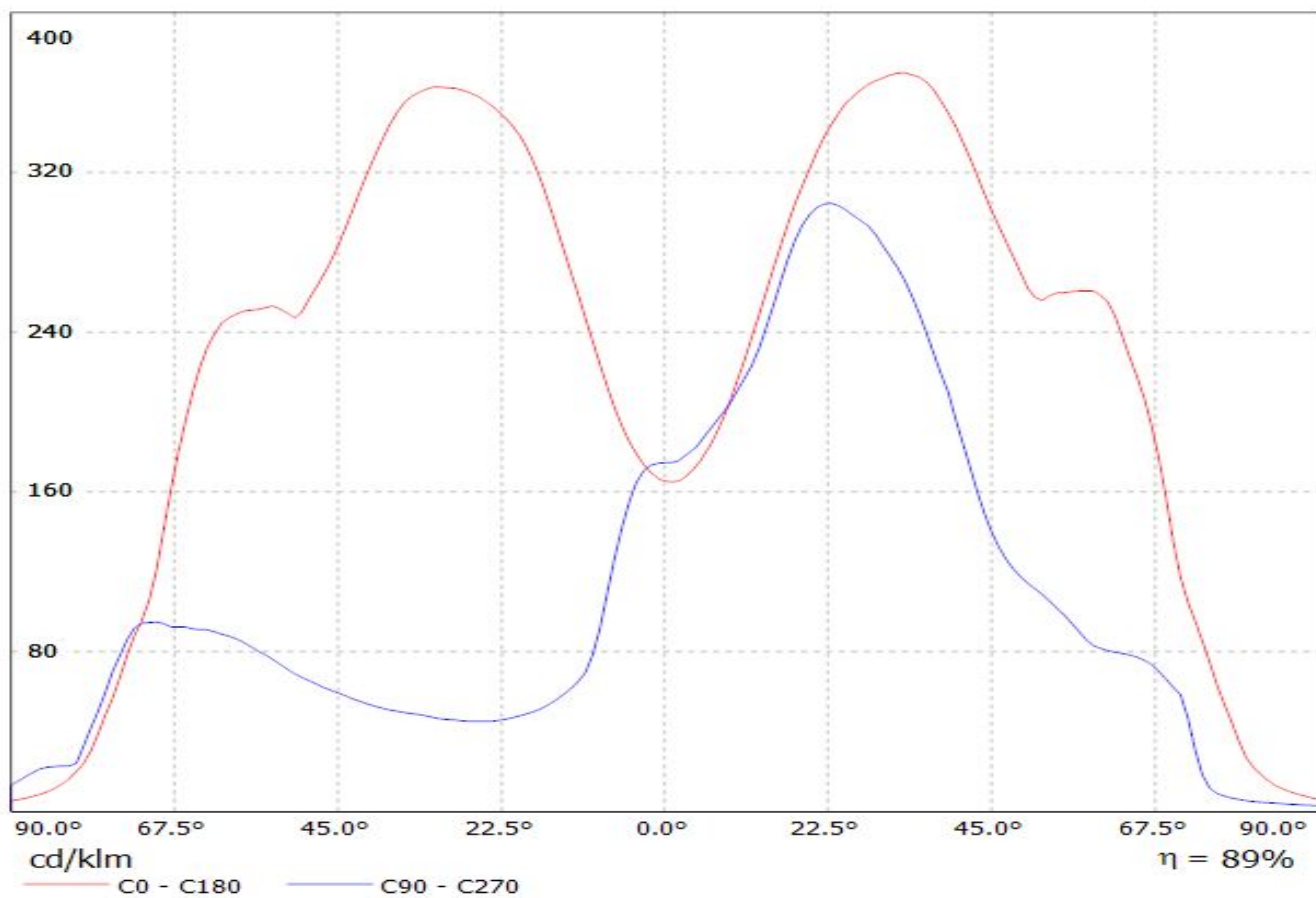

Luminaire: Ledil FN13323_STELLA-A_(CLU720)_(433_Typ_L1)

Lamps: 1 x Citizen_CLU720_(CLU720-1206B8-273M2G1)_1204.28lm@250mA_P=8.25W_I=0.25A

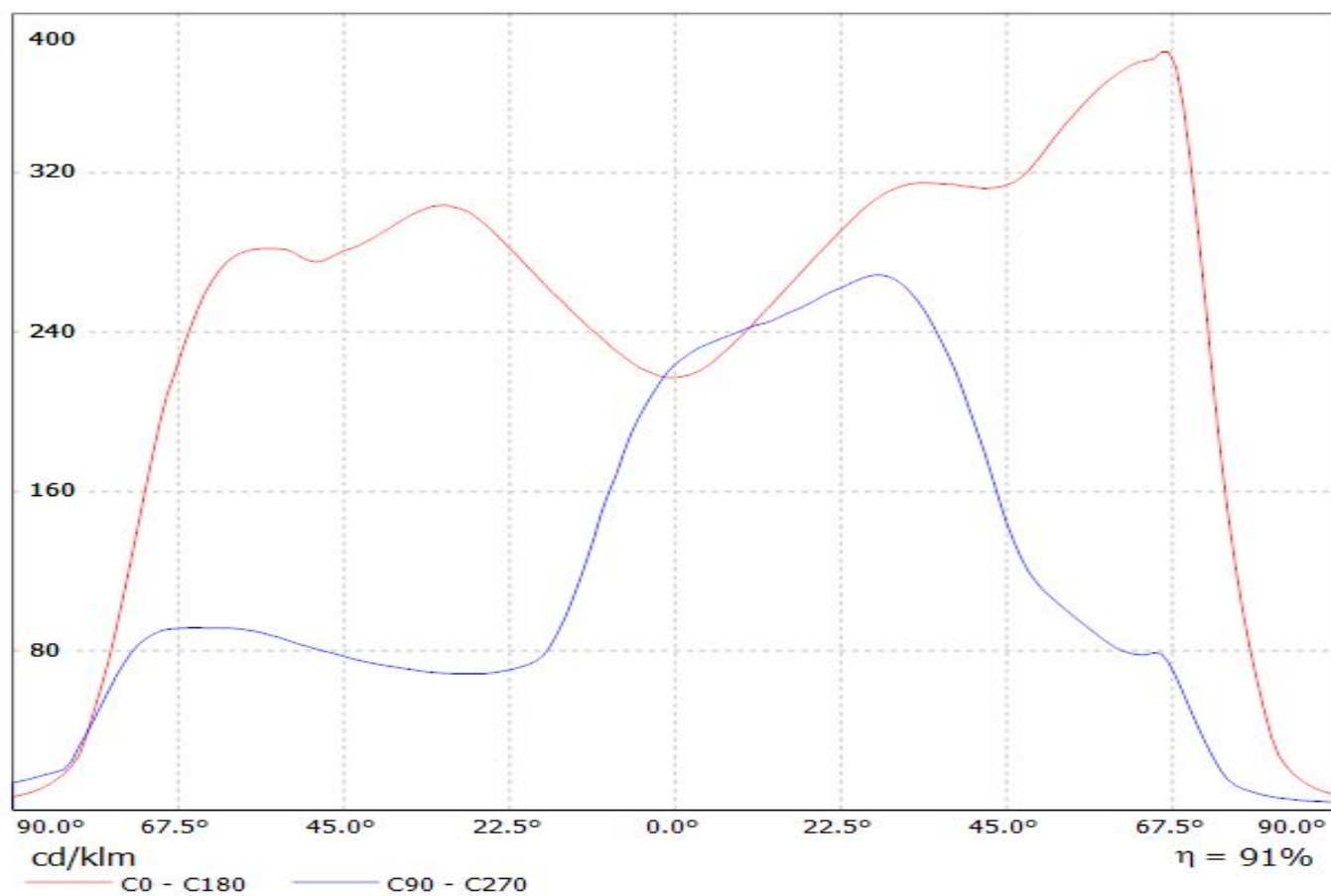

Luminaire: Ledil Oy FN14976_STELLA-DWC2_(CLU028)_SIMULATED
Lamps: 1 x Citizen CLU028-1204C4-303M2K1

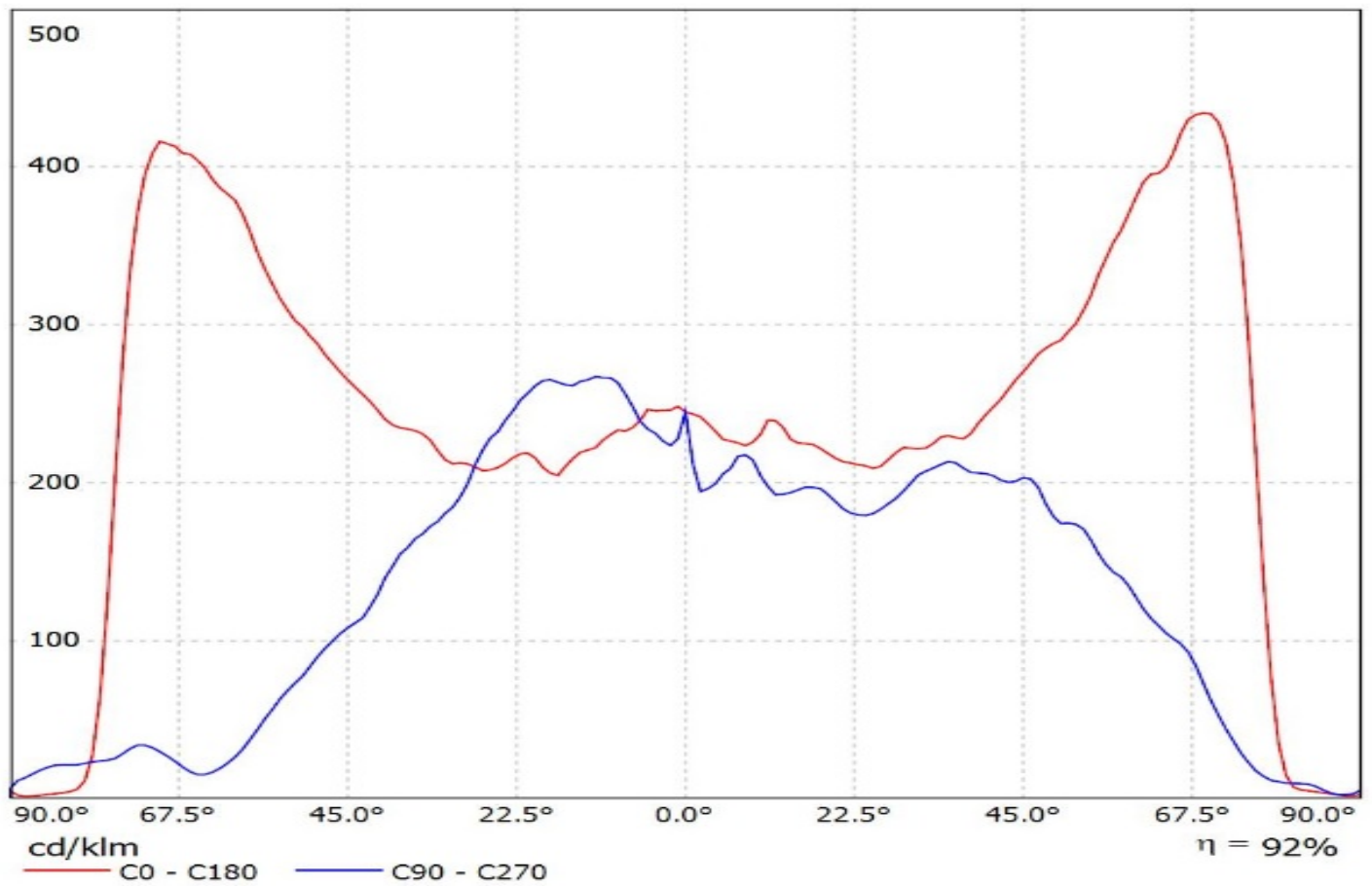

Luminaire: Ledil Oy FN13323_STELLA-A_(CLU038)_SIMULATED
Lamps: 1 x Citizen CLU038

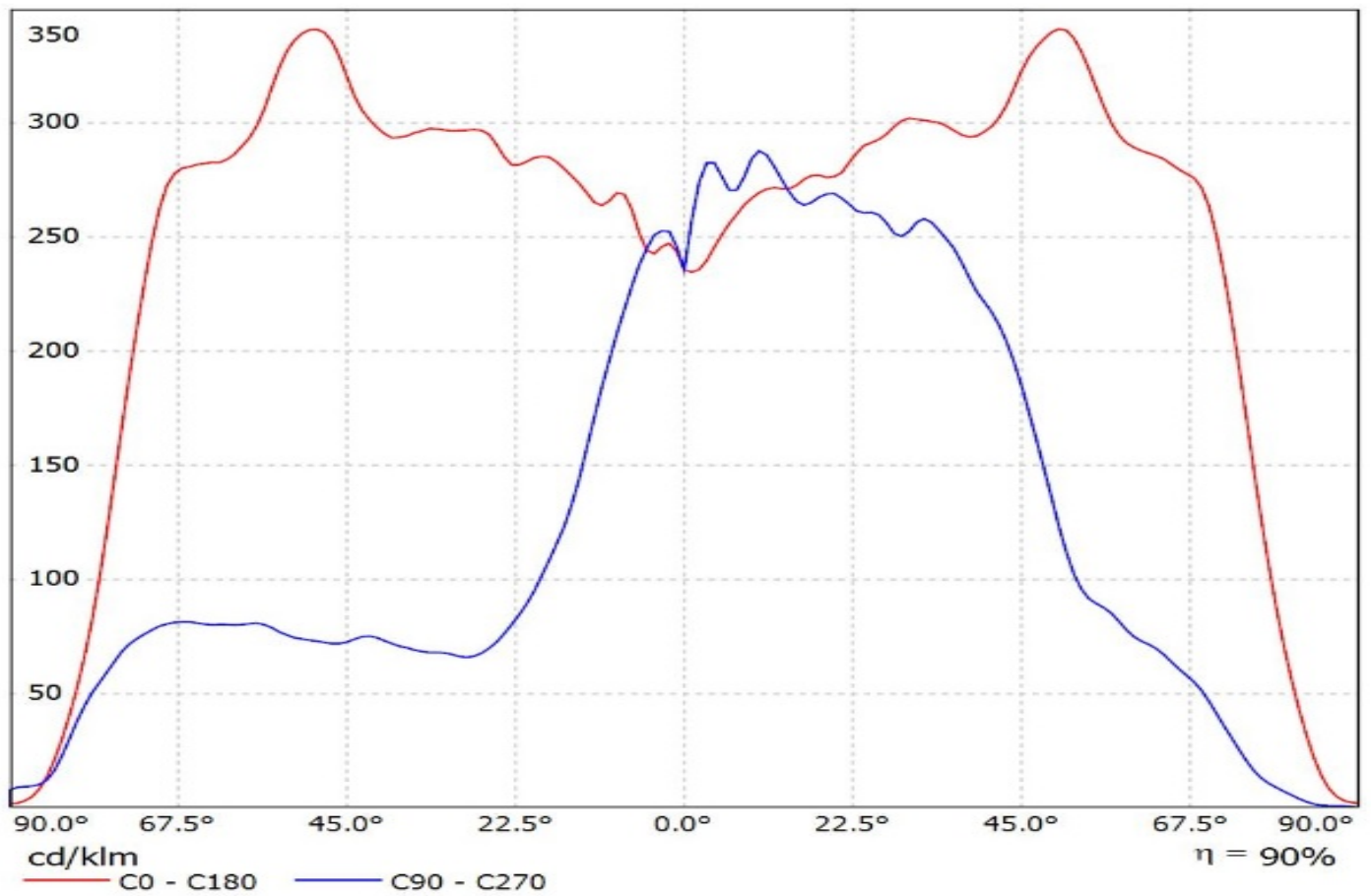

Luminaire: LEDiL Oy FN13323_STELLA-A_(CXA25) Eff. 93%
Lamps: 1 x CREE_CXA25 (CXA2530-7C0-T2-N0H)1100lm@250mA CCT=3000K P=8W I=250mA

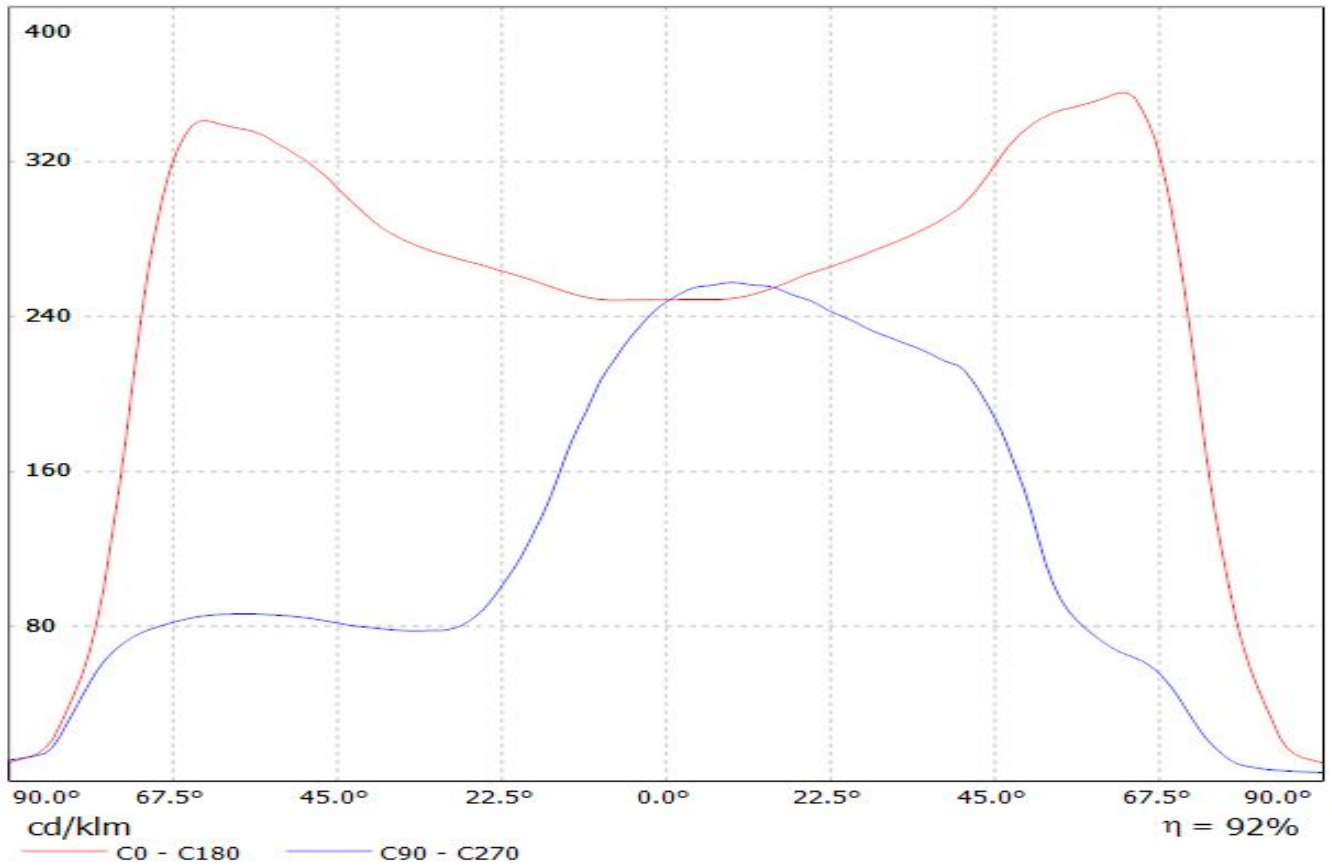

Luminaire: LEDiL Oy FN13323_STELLA-A_(CXA1507) Eff: 92%
Lamps: 1 x Cree_CXA1507_(CXA1507-30F-F2-N0A-0000) 220lm@50mA CCT=3000K P=2W I=50mA

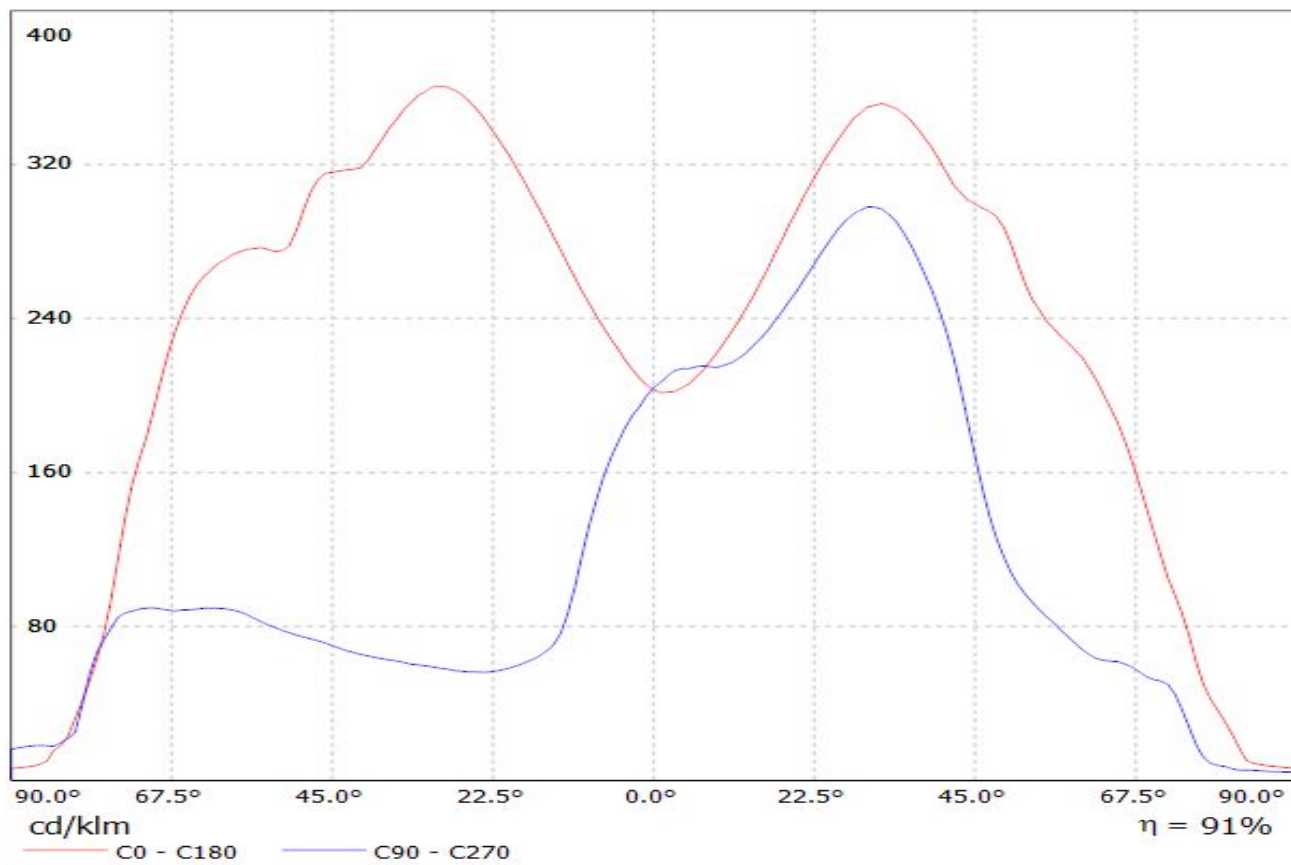

LEDiL Oy FN13323_STELLA-A_(CXA1816) Eff.87.1% / LDC (Linear)

Luminaire: LEDiL Oy FN13323_STELLA-A_(CXA1816) Eff.87.1%
Lamps: 1 x CREE_CXA1816_1075.33lm@250mA_P=8.66981W_I=249.8mA

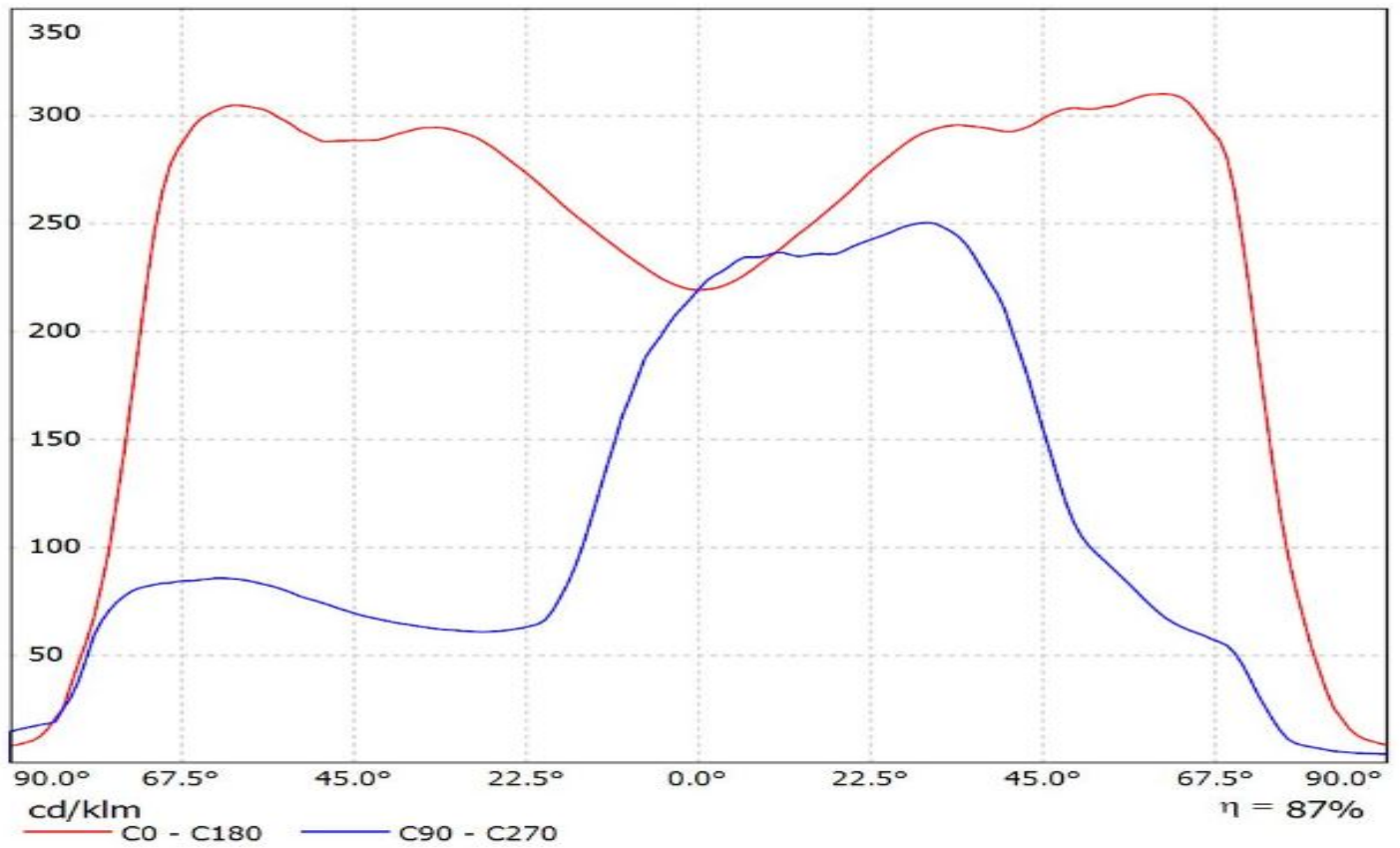

Ledil FN13323_STELLA-A_(CXA1850) / LDC (Linear)

Luminaire: Ledil FN13323_STELLA-A_(CXA1850)
Lamps: 1 x CREE_CXA1850_(CXA1850-30F-T4-N0Y-00001)
_837.004lm@250mA_CCT=3000K_P=8.24W_I=0.25A

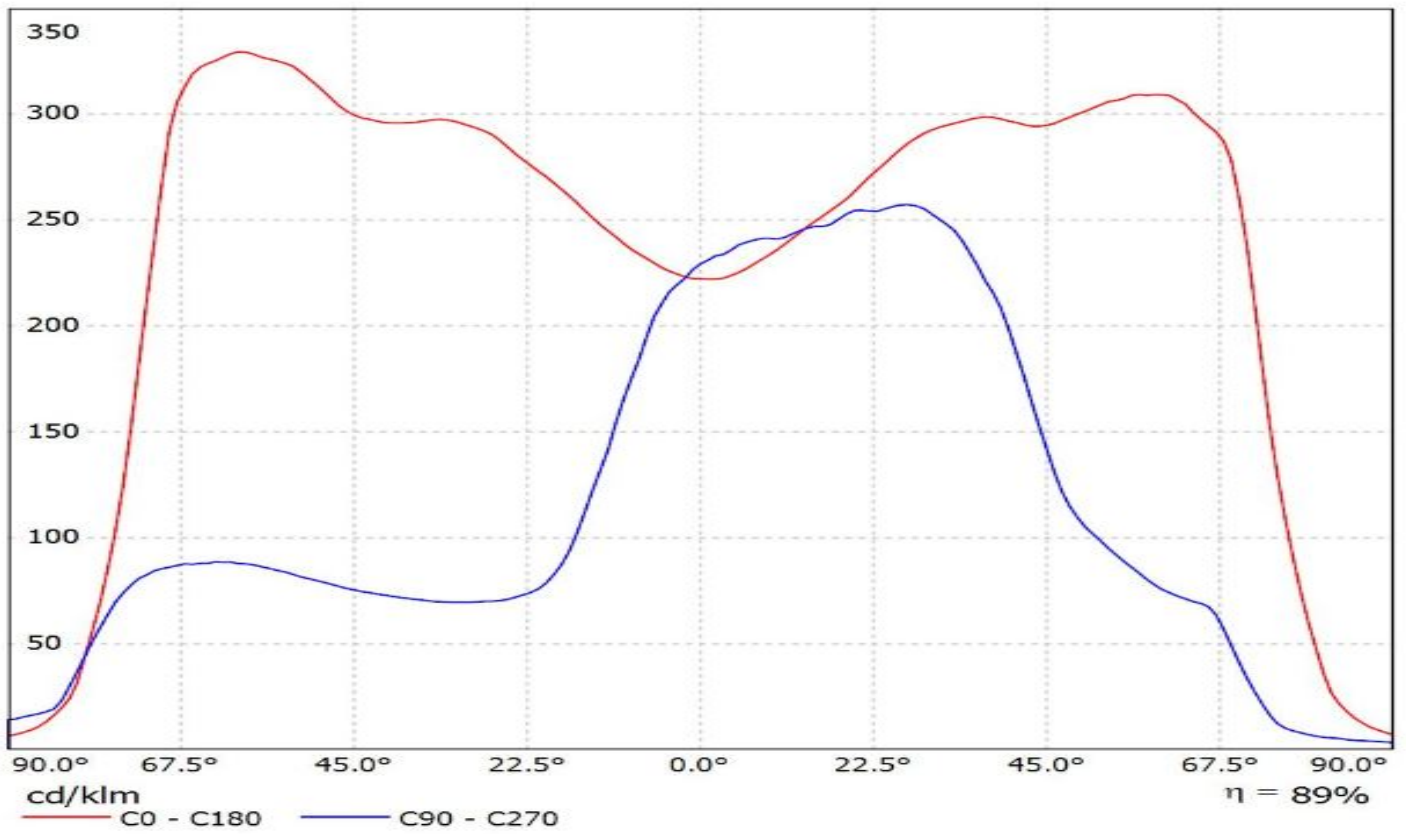

Luminaire: Ledil FN13323_STELLA-A_(CXA1520)_(441_Typ_L1) Citizen_CXA1520_(CXA1520-30F-N4-N0H-00001)_(441_Typ_L1)_1038.48lm@250mA_P=8.8025W_I=0.25A
Lamps: 1 x Citizen_CXA1520_(CXA1520-30F-N4-N0H-00001)_(441_Typ_L1)
_1038.48lm@250mA_P=8.8025W_I=0.25A

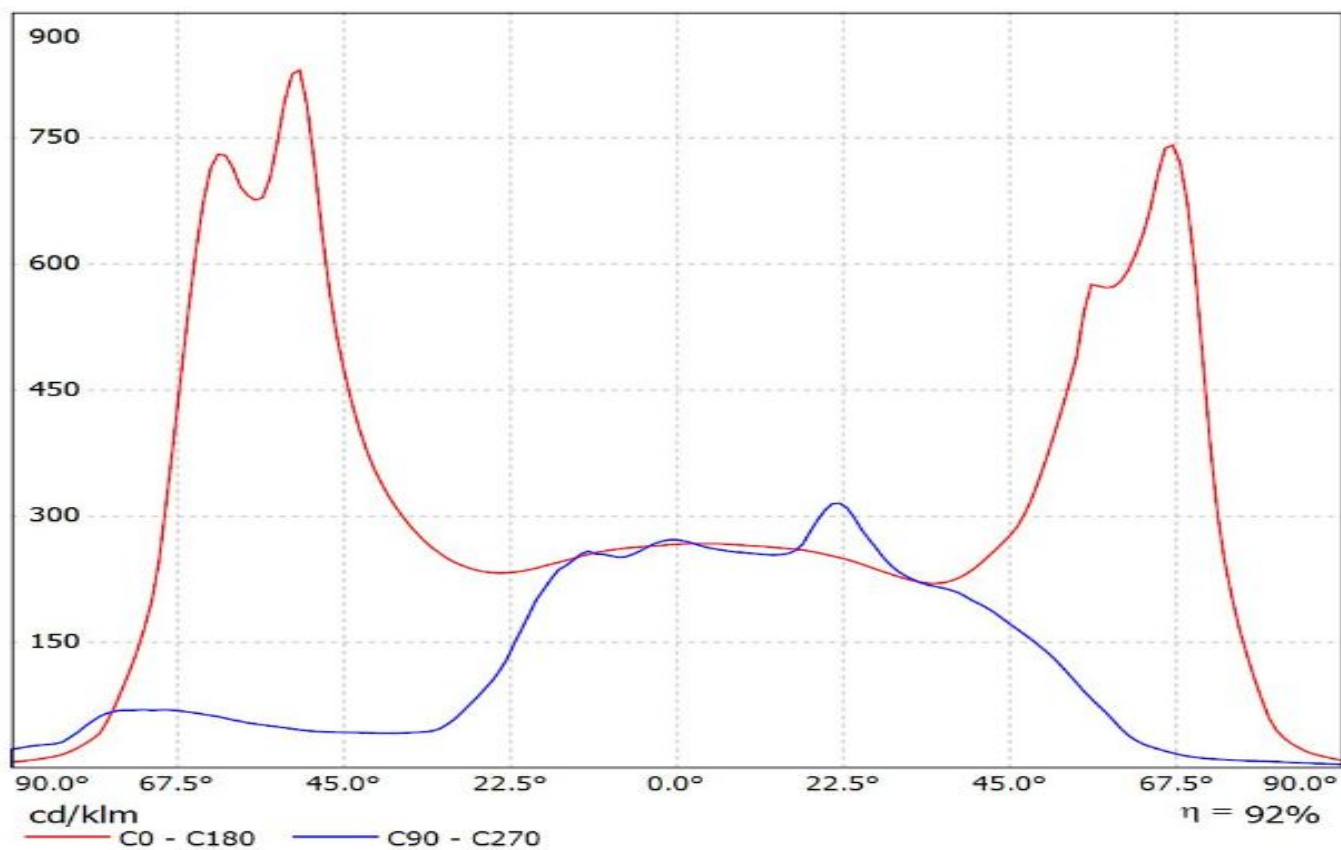

Luminaire: LEDiL Oy FN13323_STELLA-A (Luxeon_CoB_1203) (438_Typ_L1)
Lamps: 1 x Luxeon_CoB_1203_(LHC1-3080-1203)_(438_Typ_L1)_1005.18lm@250mA_P=8.69829W_I=0.2498A

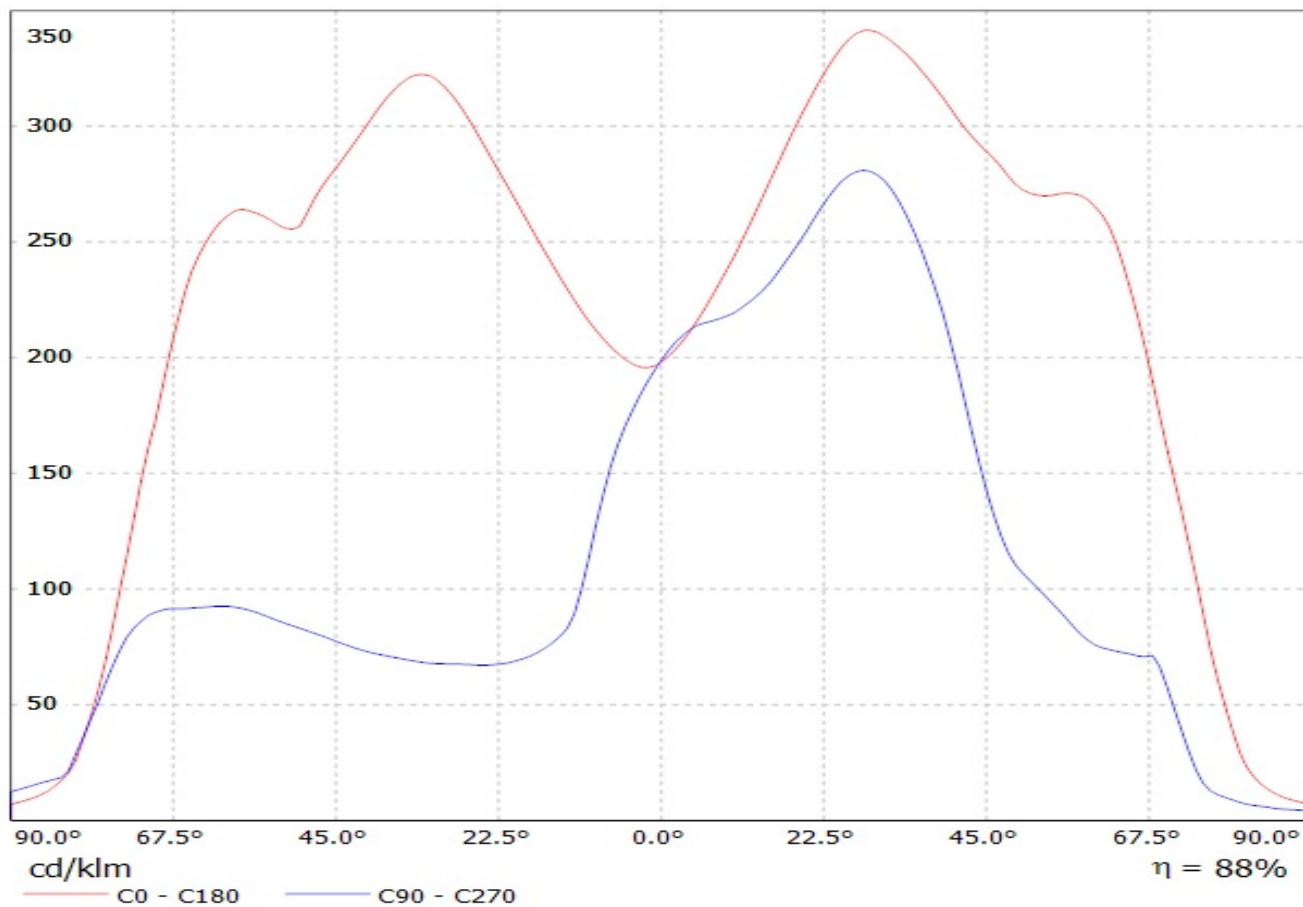

Luminaire: LEDiL Oy FN13323_STELLA-A_(CXM-18) Eff.89.2%
Lamps: 1 x LUMINUS_XNOVA_CXM-18_897.842lm@250mA_P=8.12425W_I=249.9mA

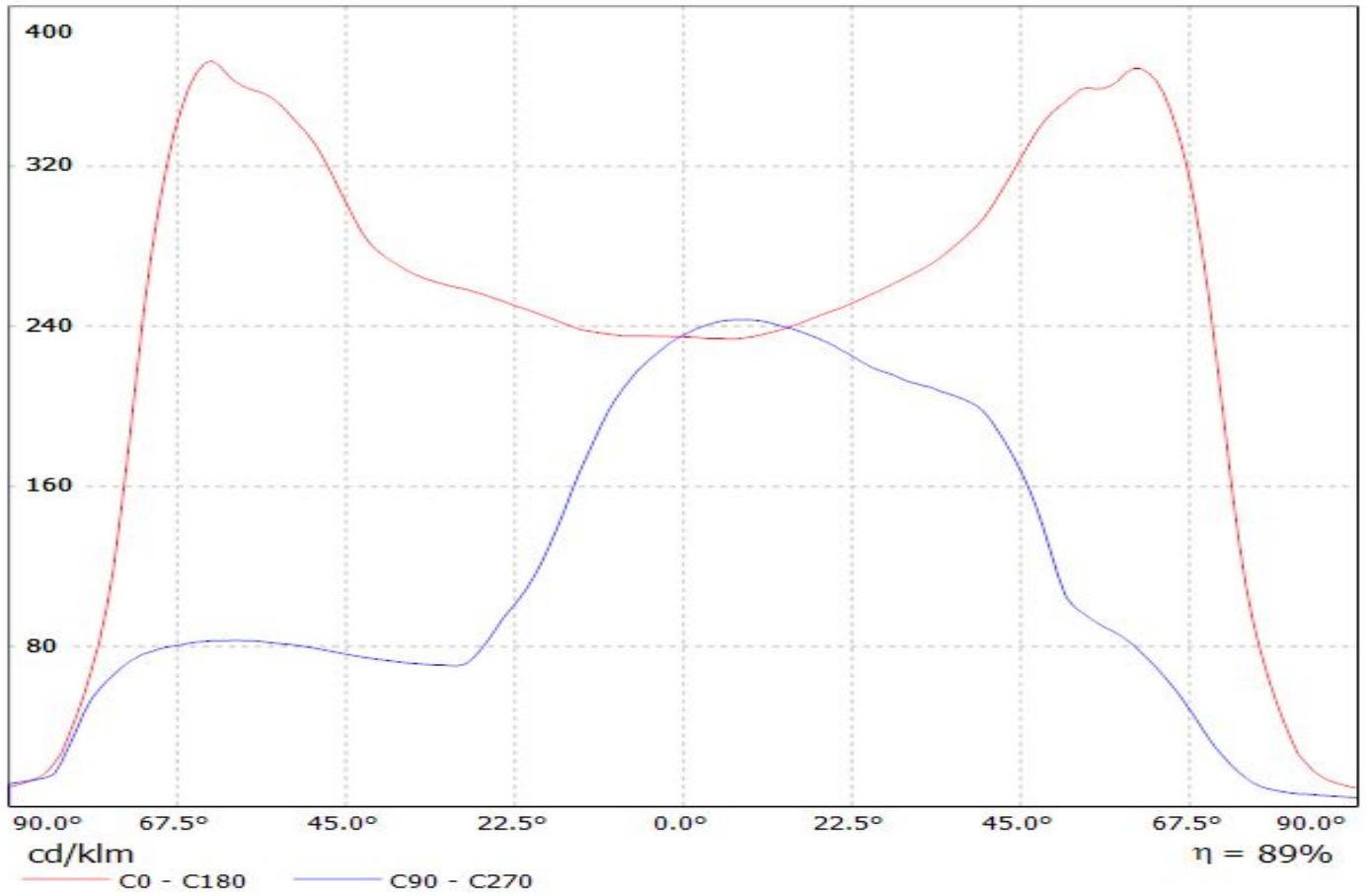

Luminaire: LEDiL Oy FN13323_STELLA-A_(CXM-14)
Lamps: 1 x LUMINUS_XNOVA_CXM-14_(AC00)
_1064.17lm@250mA_CCT=3133K_P=8.33558W_I=249.8mA

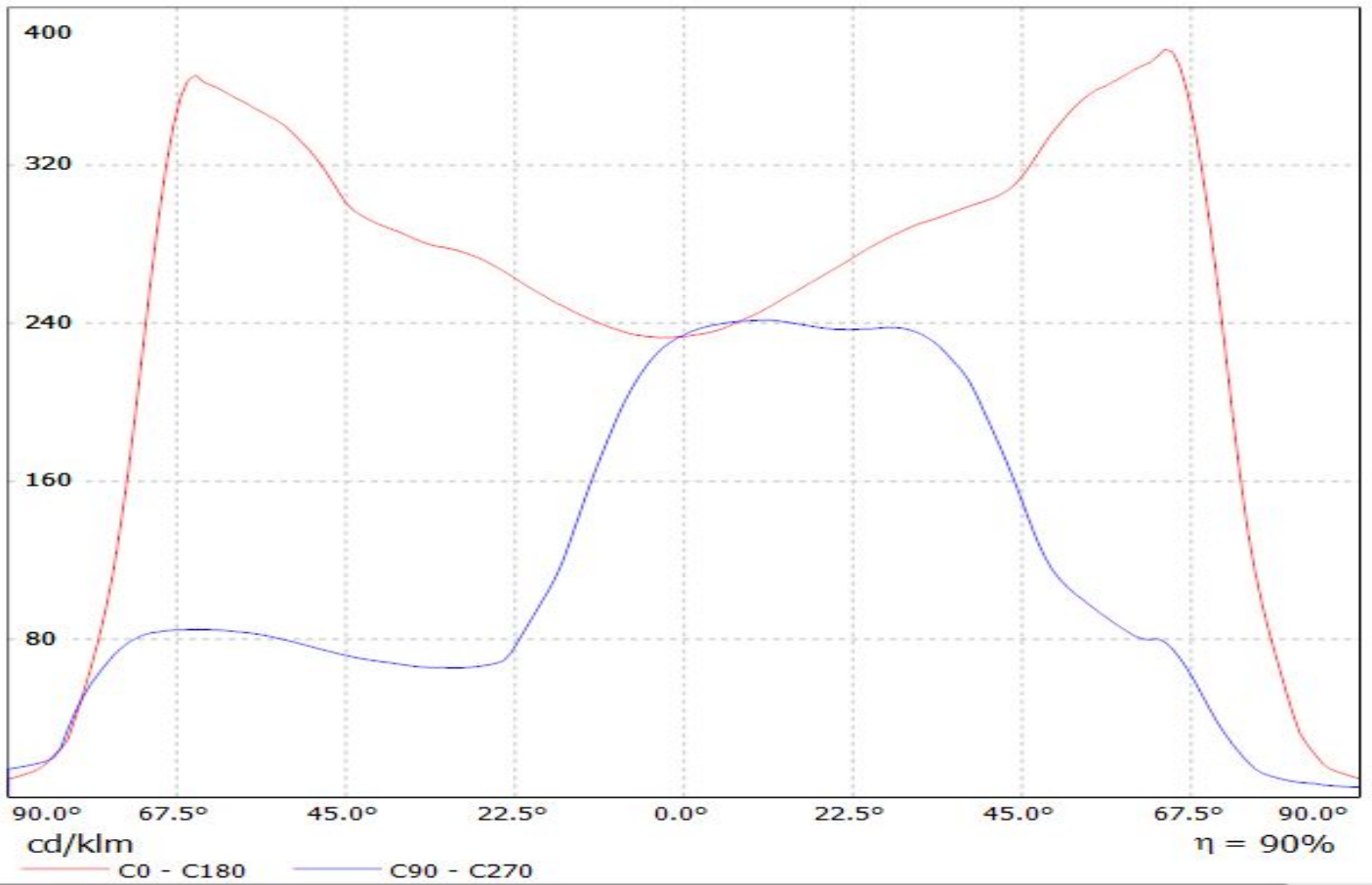

Ledil FN13323_STELLA-A_(NFCLL036B) / LDC (Linear)

Luminaire: Ledil FN13323_STELLA-A_(NFCLL036B)
Lamps: 1 x Nichia_NFCLL036B_(SM403J1300R8000)
_563.488lm@100mA_CCT=4000K_P=3.35W_I=0.100A

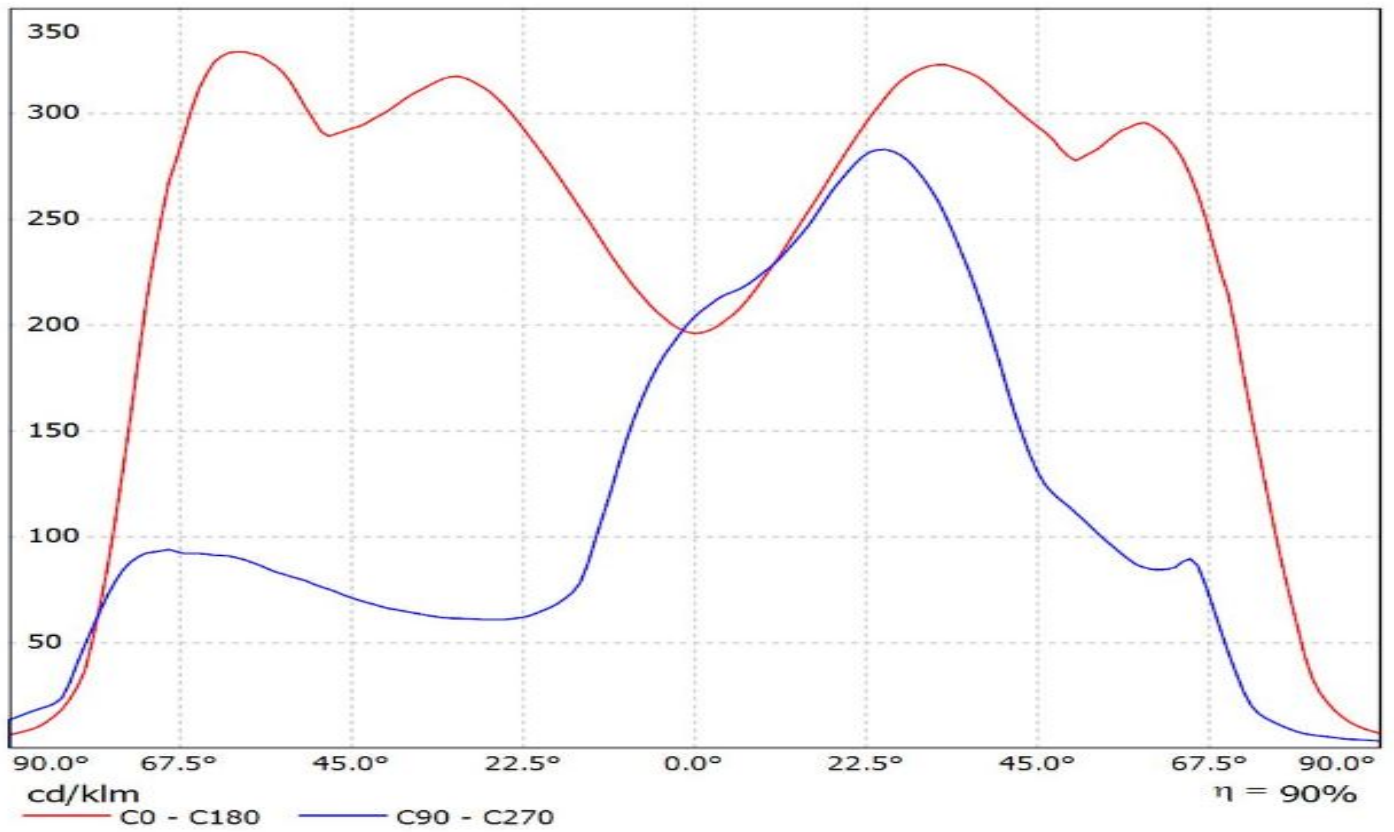

Ledil FN13323_STELLA-A_(NFCLL060B) / LDC (Linear)

Luminaire: Ledil FN13323_STELLA-A_(NFCLL060B)

Lamps: 1 x Nichia_NFCLL060B_(sm406G2450R8000)_1368.94lm@250mA_P=8.5W_I=0.25A

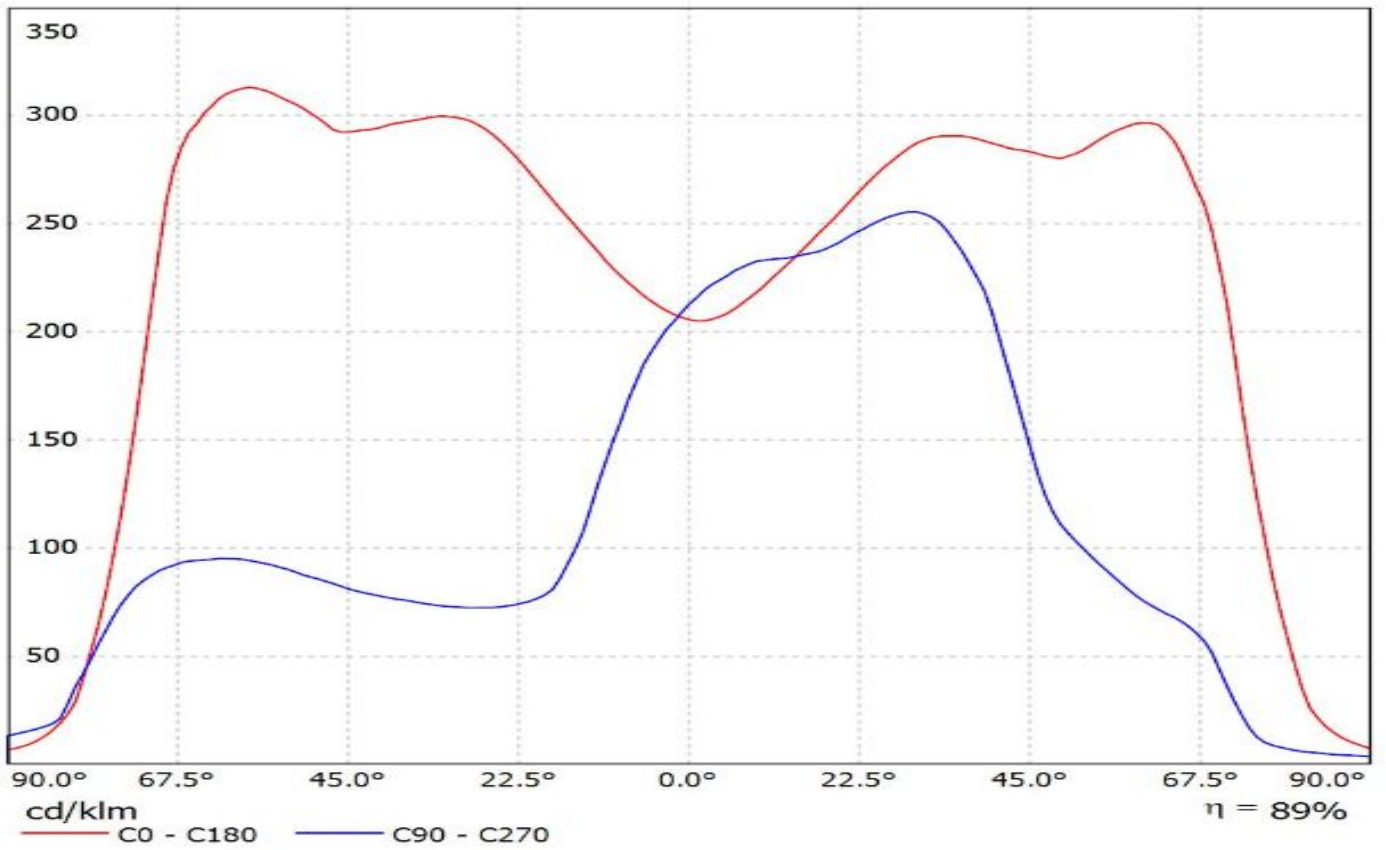

Luminaire: LEDiL Oy FN13323_STELLA-A_(SOLERIQ_S19)

Lamps: 1 x OSRAM_SOLERIQ_S19_(GW_KAHJB1.EM)_1340.3lm@250mA_CCT=3000K_P=10.4491W_I=249.8mA

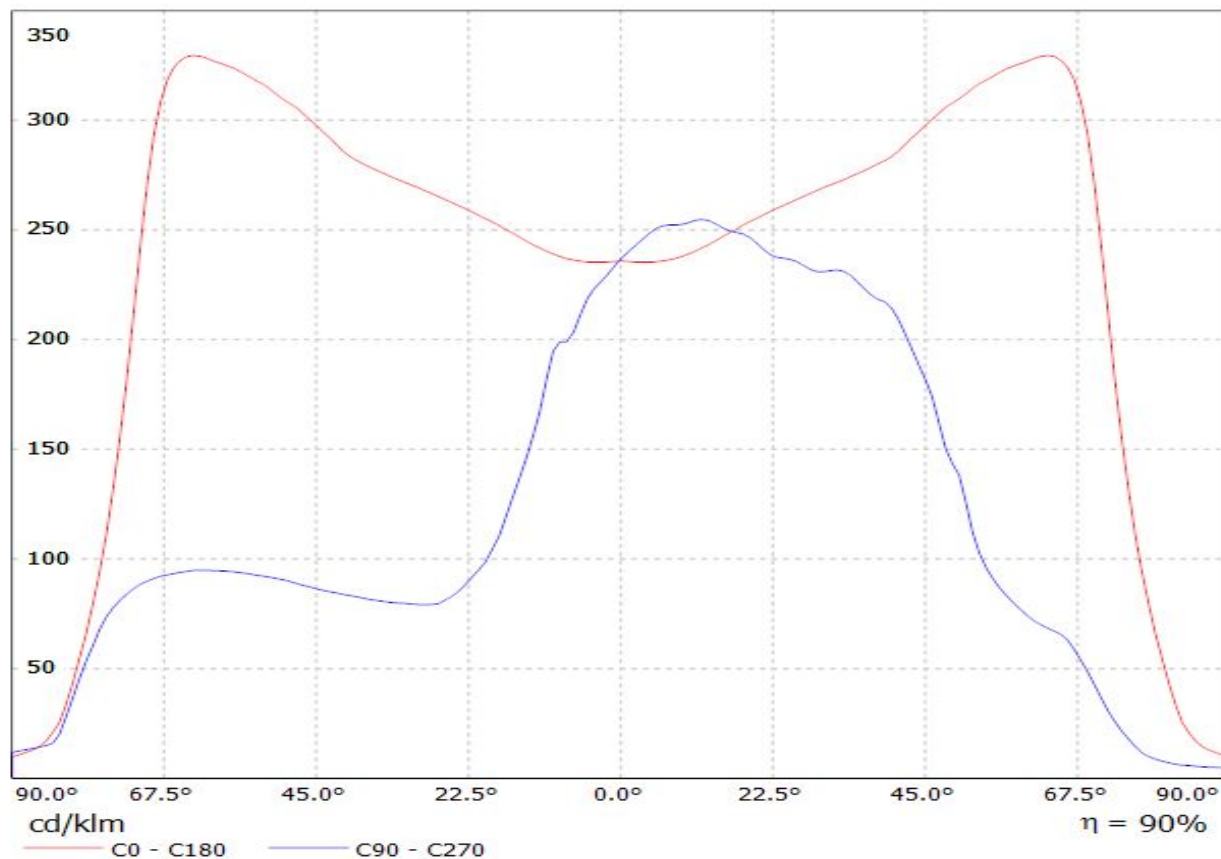

Luminaire: LEDiL Oy FN13323_STELLA-A_(Soleriq_S13)

Lamps: 1 x Osram_Soleriq_S13_802.964lm@250mA_CCT=3125K_P=7.26069W_I=249.8mA

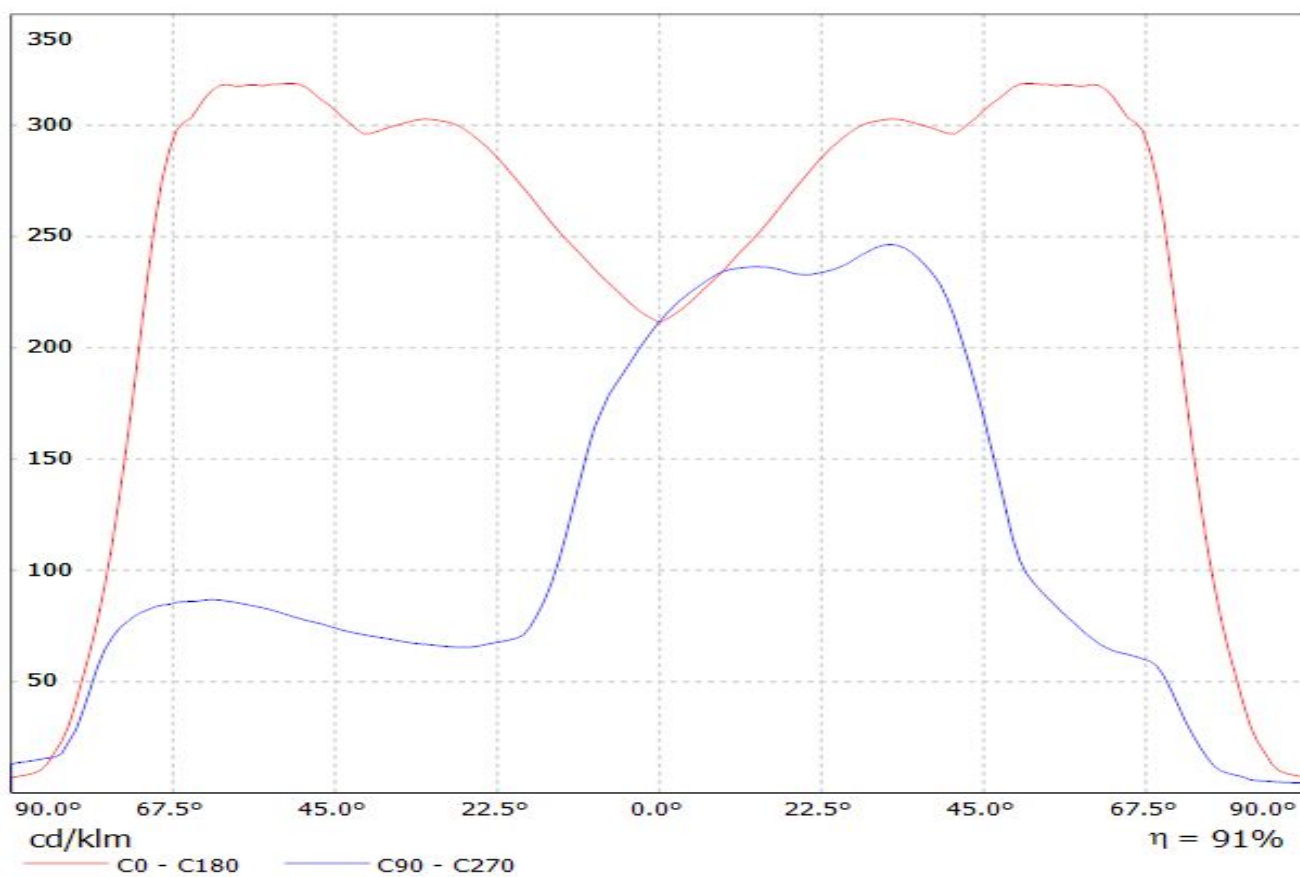

Luminaire: LEDiL Oy FN13323_STELLA-A_(SOLERIQ_P13)

Lamps: 1 x SOLERIQ_P13_(GW_MAGMB1.EM)_929.576lm@250mA_CCT=3500K_P=8.72876W_I=249.8mA

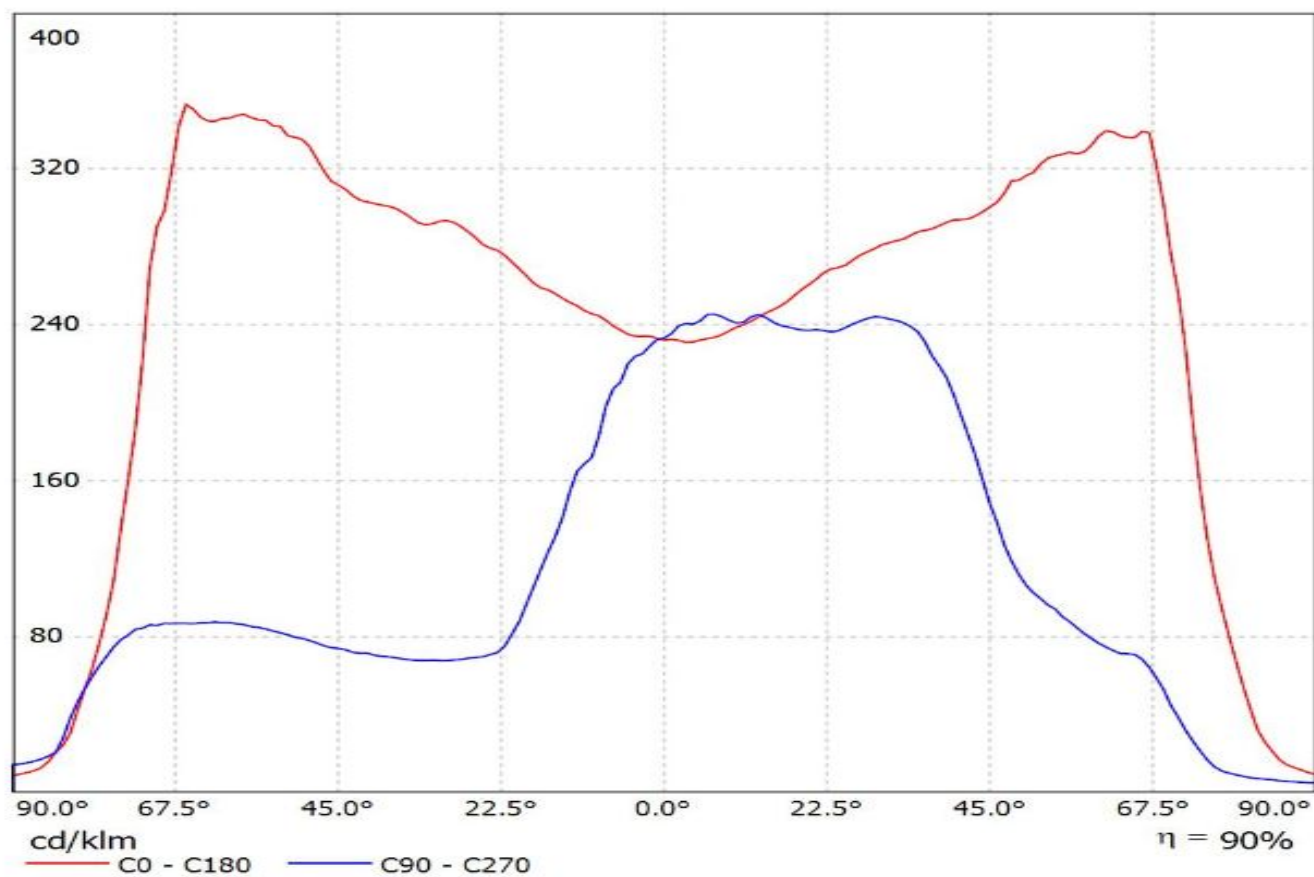

Ledil FN13323_STELLA-A_(P13) / LDC (Linear)

Luminaire: Ledil FN13323_STELLA-A_(P13)
Lamps: 1 x Osram Soleriq P13 (GW MAGMB1.EM)
_929.576lm@250mA_CCT=3500K_P=8.72876W_I=249.8mA

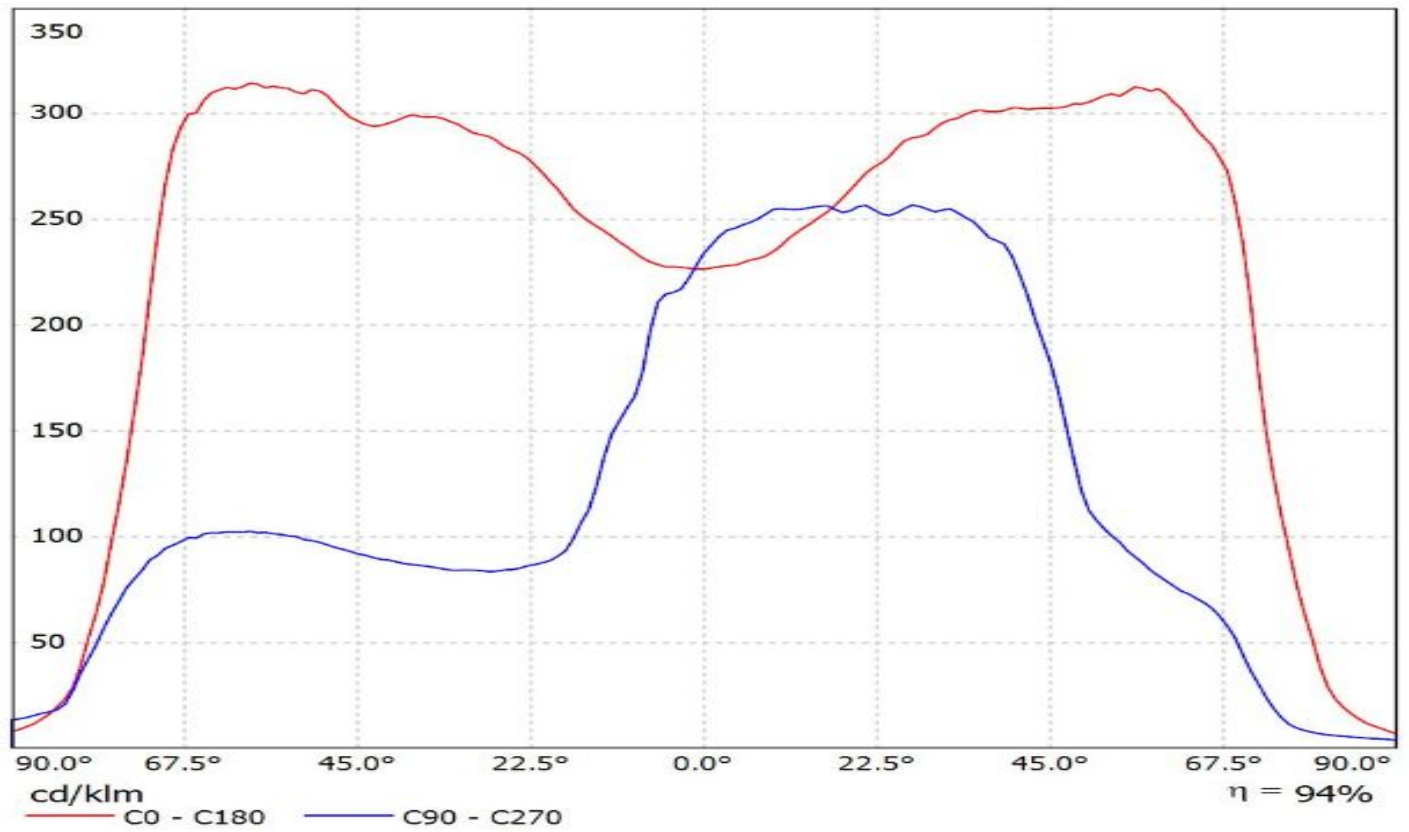

Ledil FN13323_STELLA-A_(Soleriq_S13) / LDC (Linear)

Luminaire: Ledil FN13323_STELLA-A_(Soleriq_S13)

Lamps: 1 x Osram_Soleriq_S13_(GW_KAGHB1.EM)_875.214lm@250mA_P=7.44679W_I=250mA

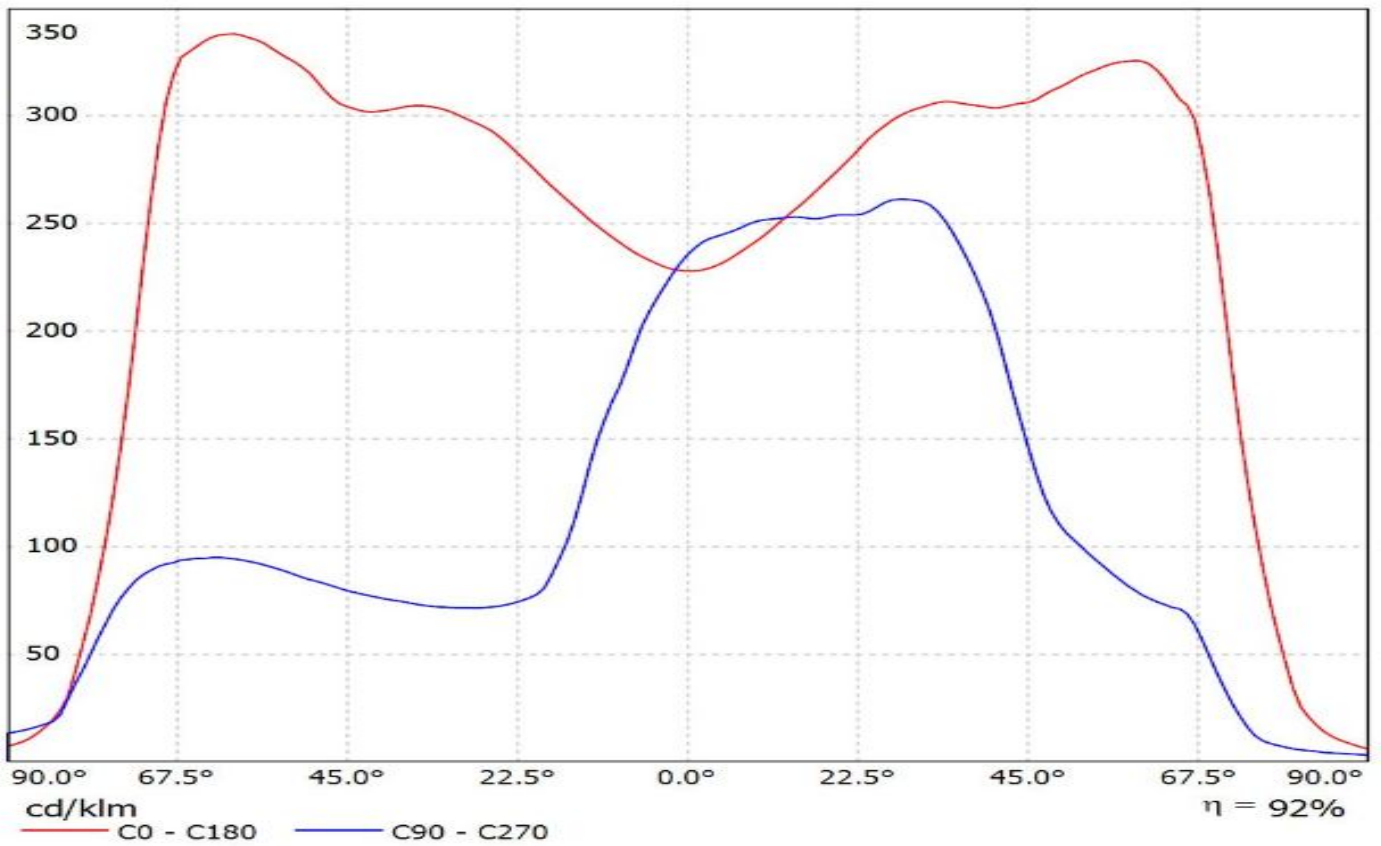

Luminaire: Ledil FN13323_STELLA-A_(Soleriq_P9)

Lamps: 1 x Osram_Soleriq_P9_(GW_MAFJB1.EM)_976.011lm@250mA_CCT=4299K_P=6.9W_I=0.25A

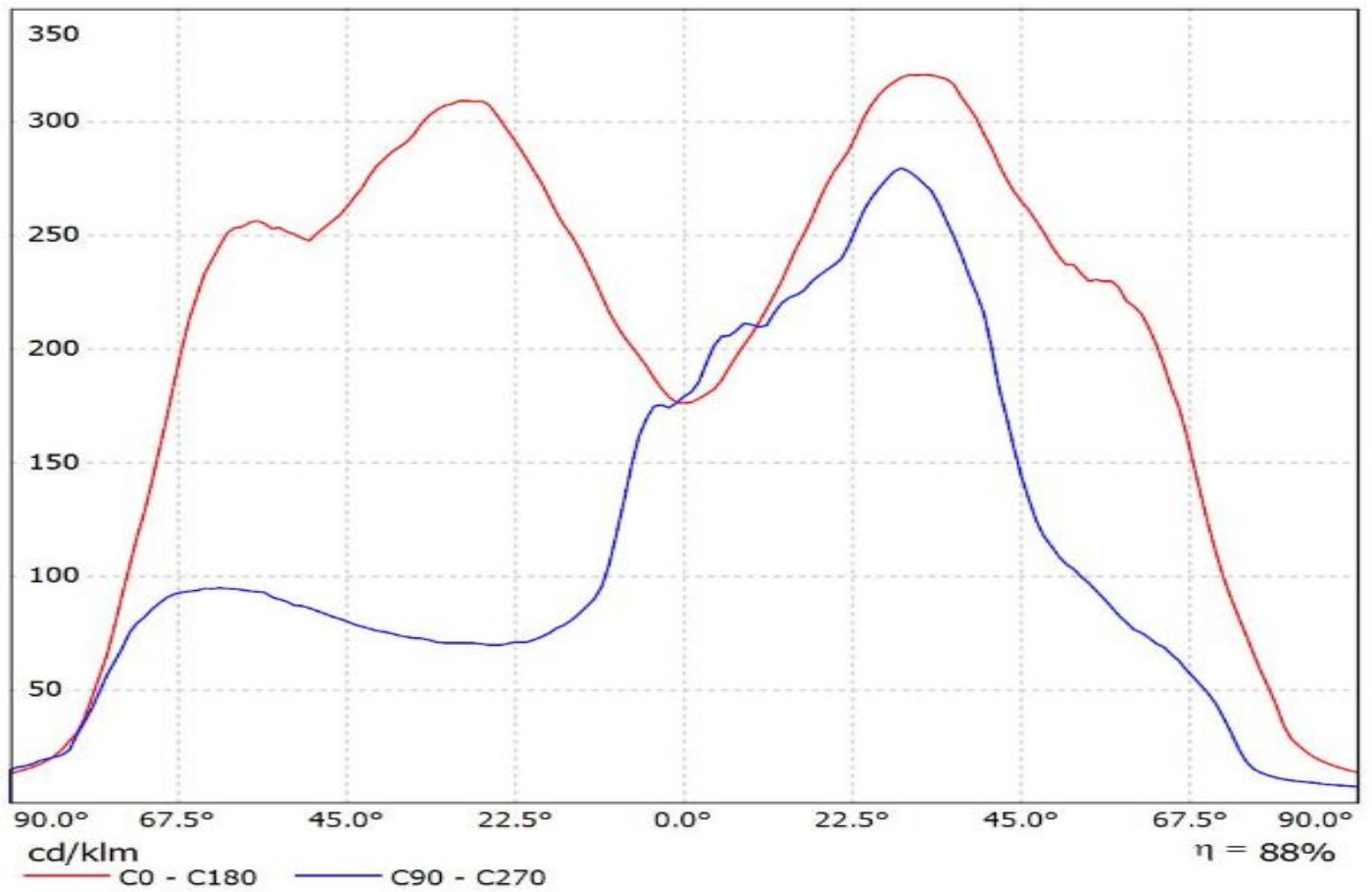

Luminaire: LEDiL Oy FN13323_STELLA-A (Megazenigata_GW6D) Eff.89.9%
Lamps: 1 x SHARP_Megazenigata_(GW6DMC40NFC)_1072.13lm@250mA_P=8.51443W_I=249.8mA

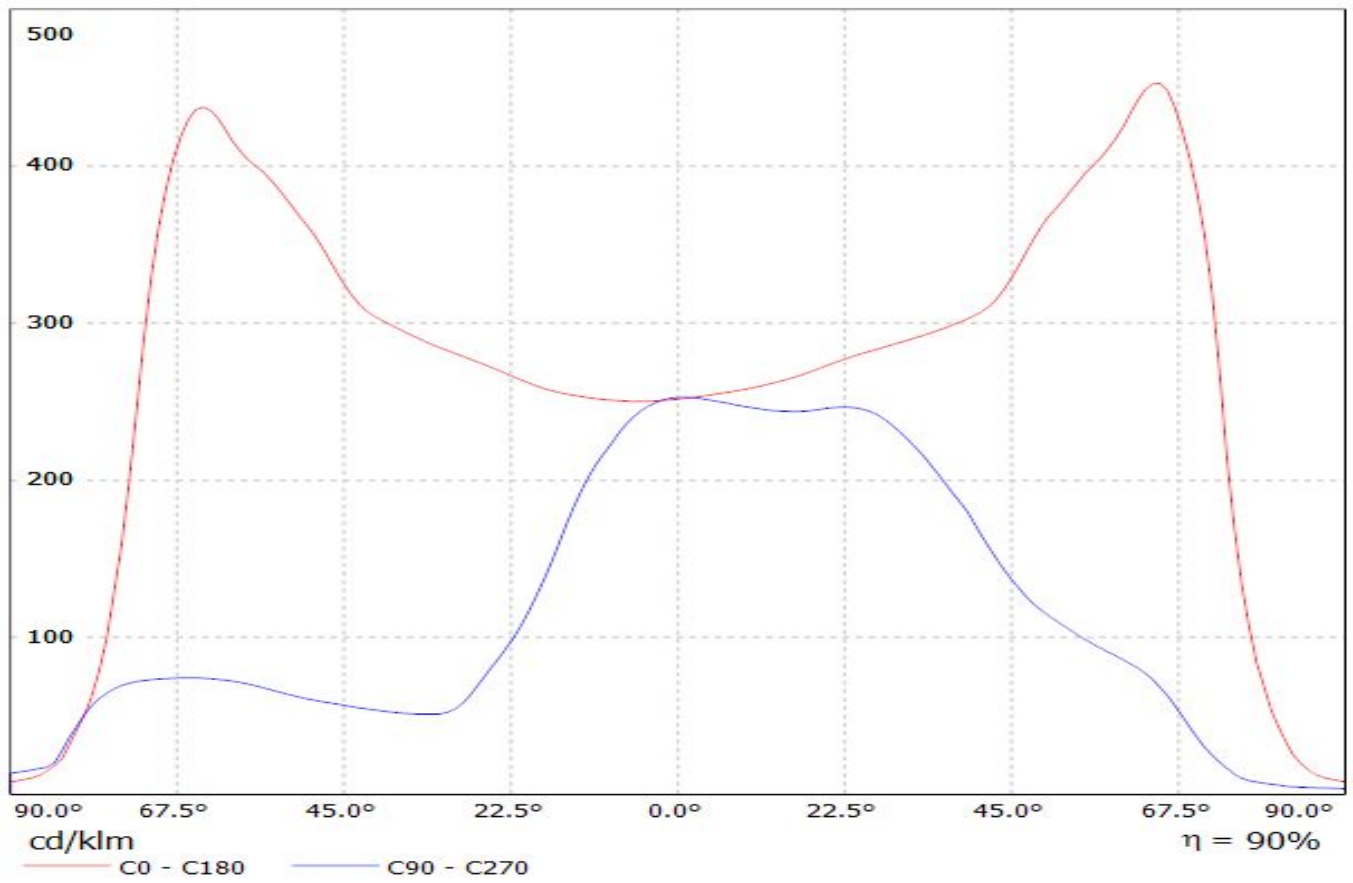

Luminaire: LEDiL Oy FN13323_STELLA-A_(SLE-G5_LES-15)

Lamps: 1 x Tridonic_SLE-G5_LES-15_1280.24lm@250mA_P=8.6273W_I=0.250A

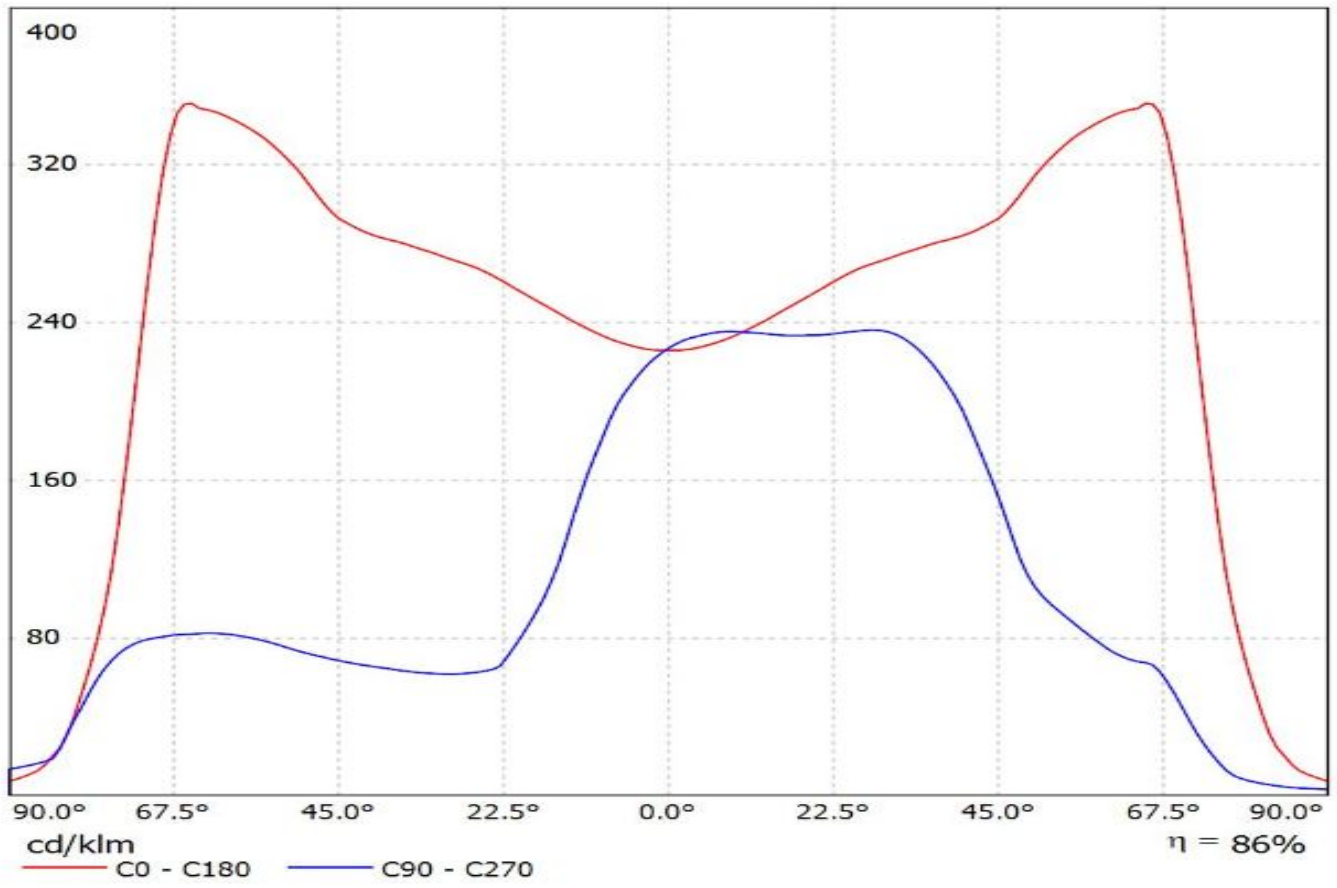

Luminaire: LEDiL Oy FN13323_STELLA-A Eff. 92%

Lamps: 1 x VERO13 (BXRC-30E4000F) 819lm@250mA CCT=3000K P=7.5W I=250mA

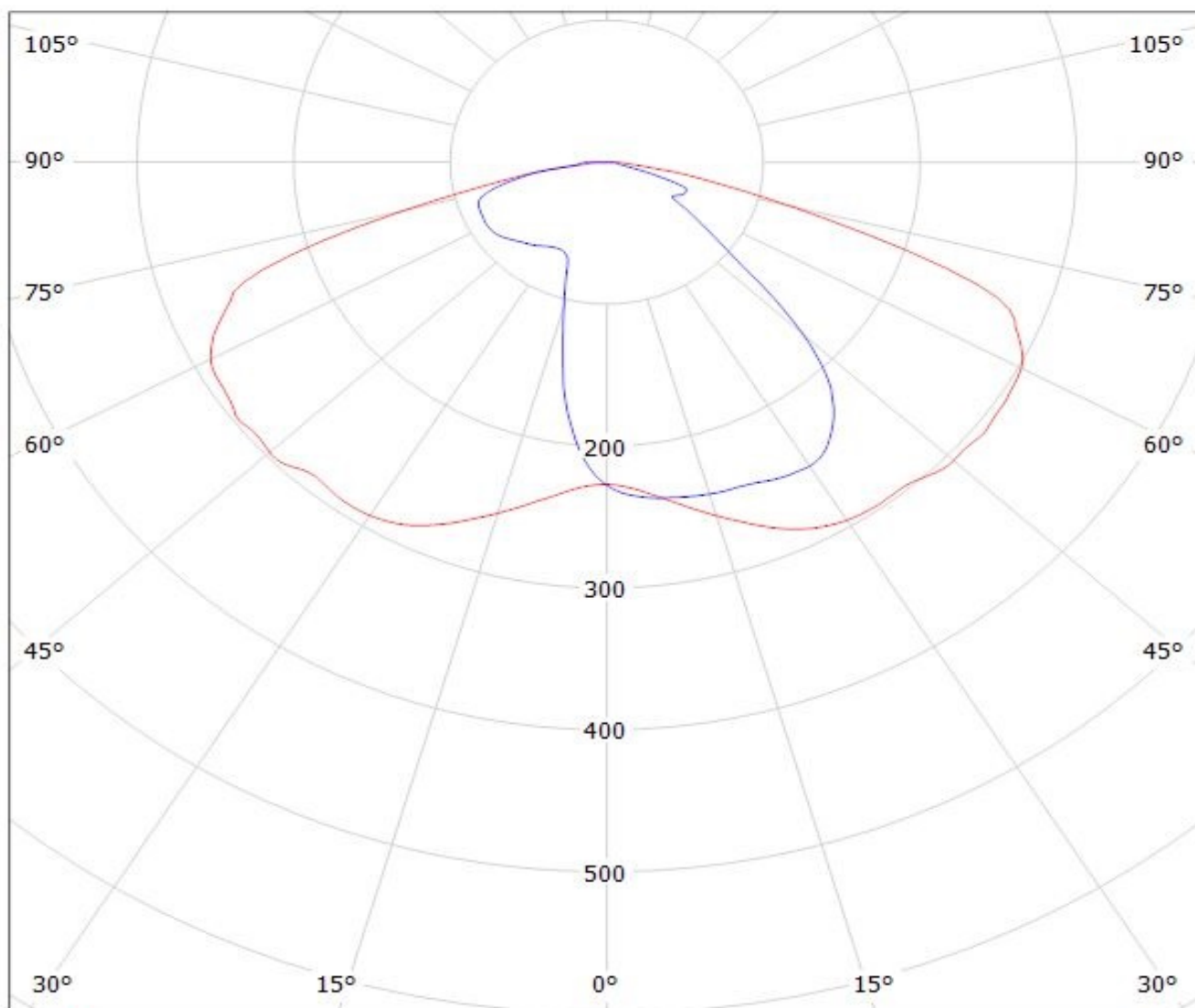

cd/klm

— C0 - C180

— C90 - C270

Luminaire: LEDiL Oy FN13323_STELLA-A (VERO18) Eff. 92%

Lamps: 1 x VERO18 (BXRC-30E4000F)786lm@250mA CCT=3000K P=6.84W I=250mA

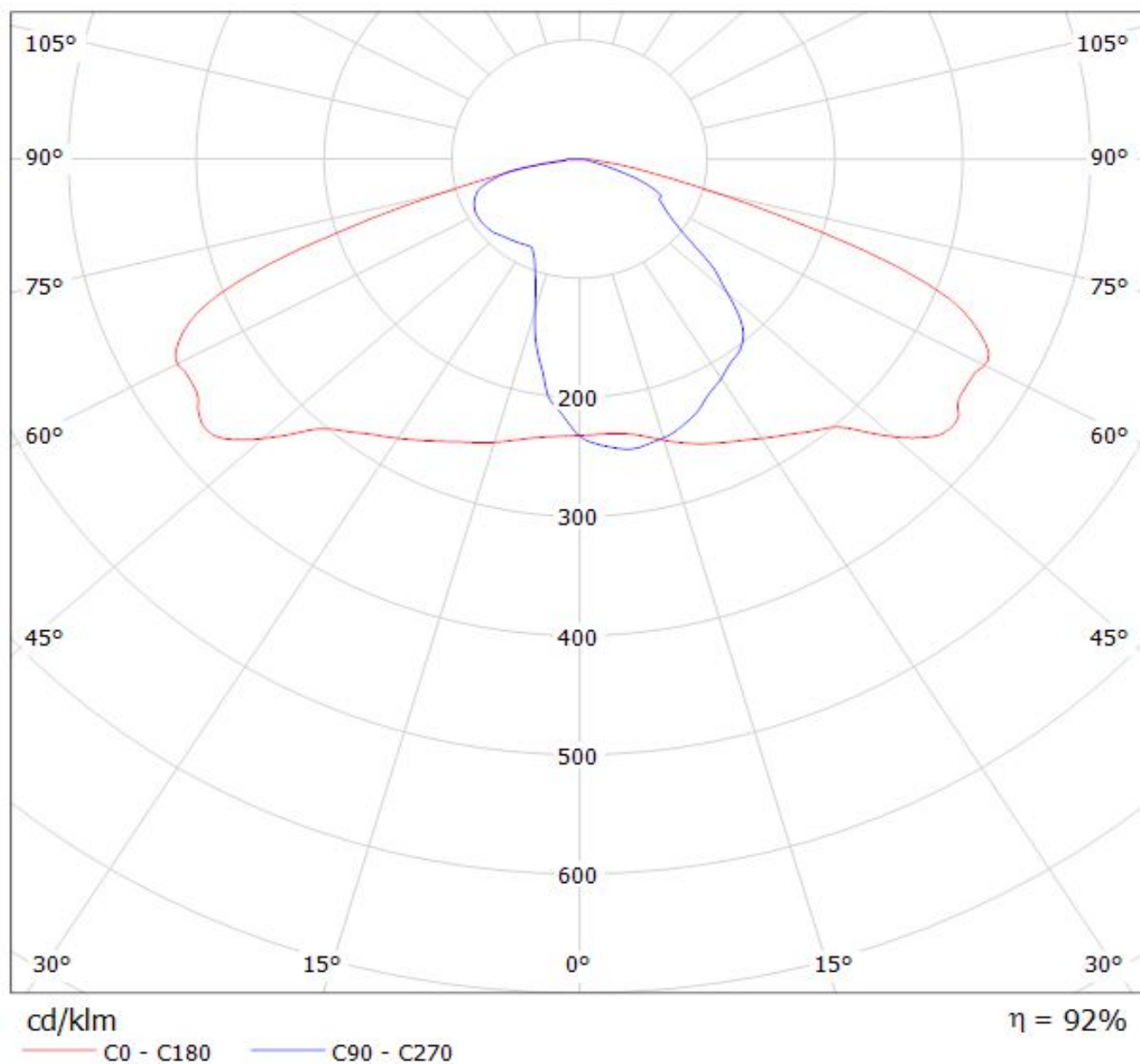

Luminaire: LEDiL Oy FN13323_STELLA-A_(V15)

Lamps: 1 x Bridgelux_V15_1050.21lm@250mA_P=8.19169W_I=249.8mA

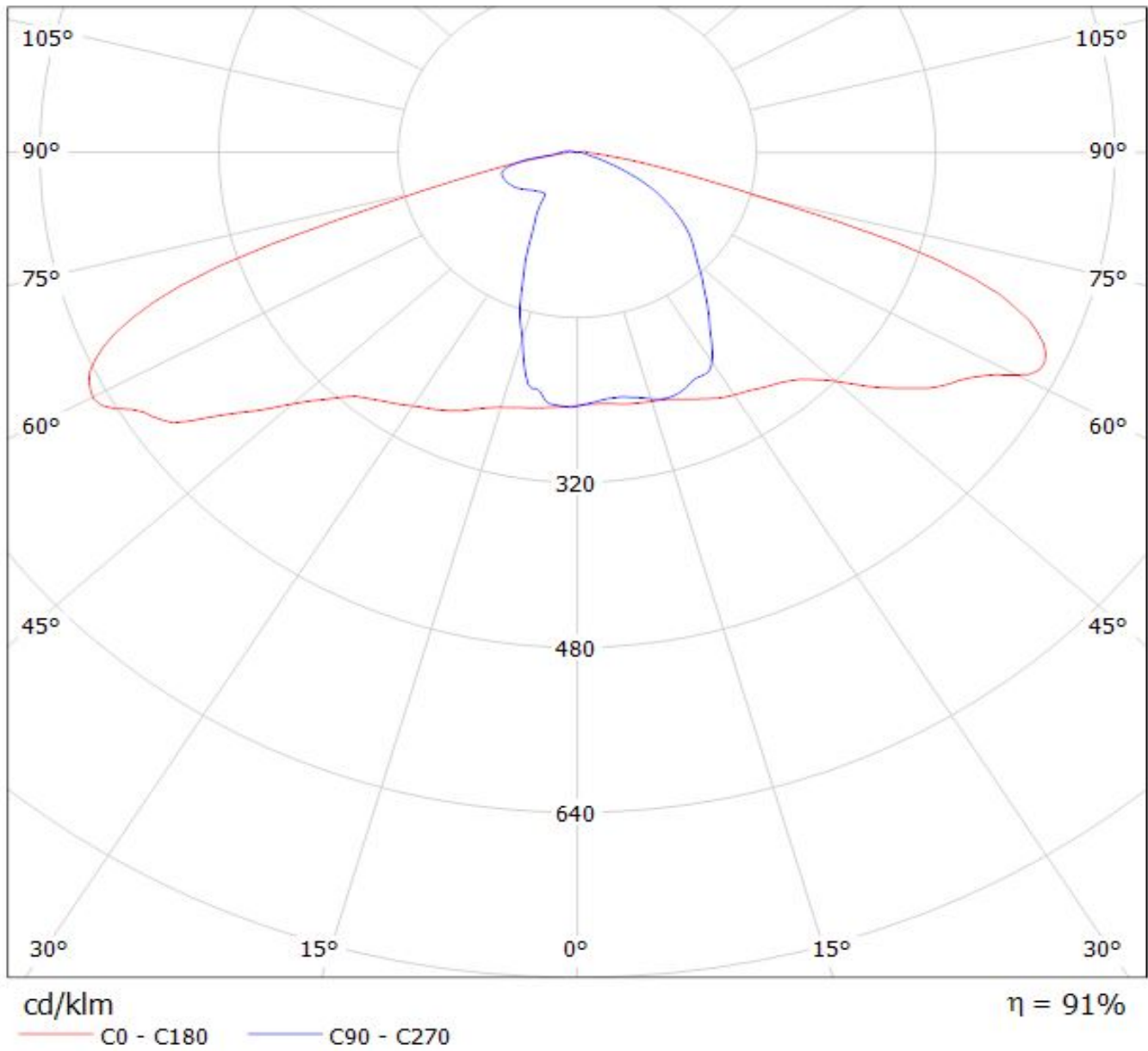

Luminaire: Ledil Oy FN13323_STELLA-A+_Bender+Wirth 434 Typ L1_BRIDGELUX_V10_Gen7_SIMULATED
Lamps: 1 x BRIDGELUX V10 Gen7

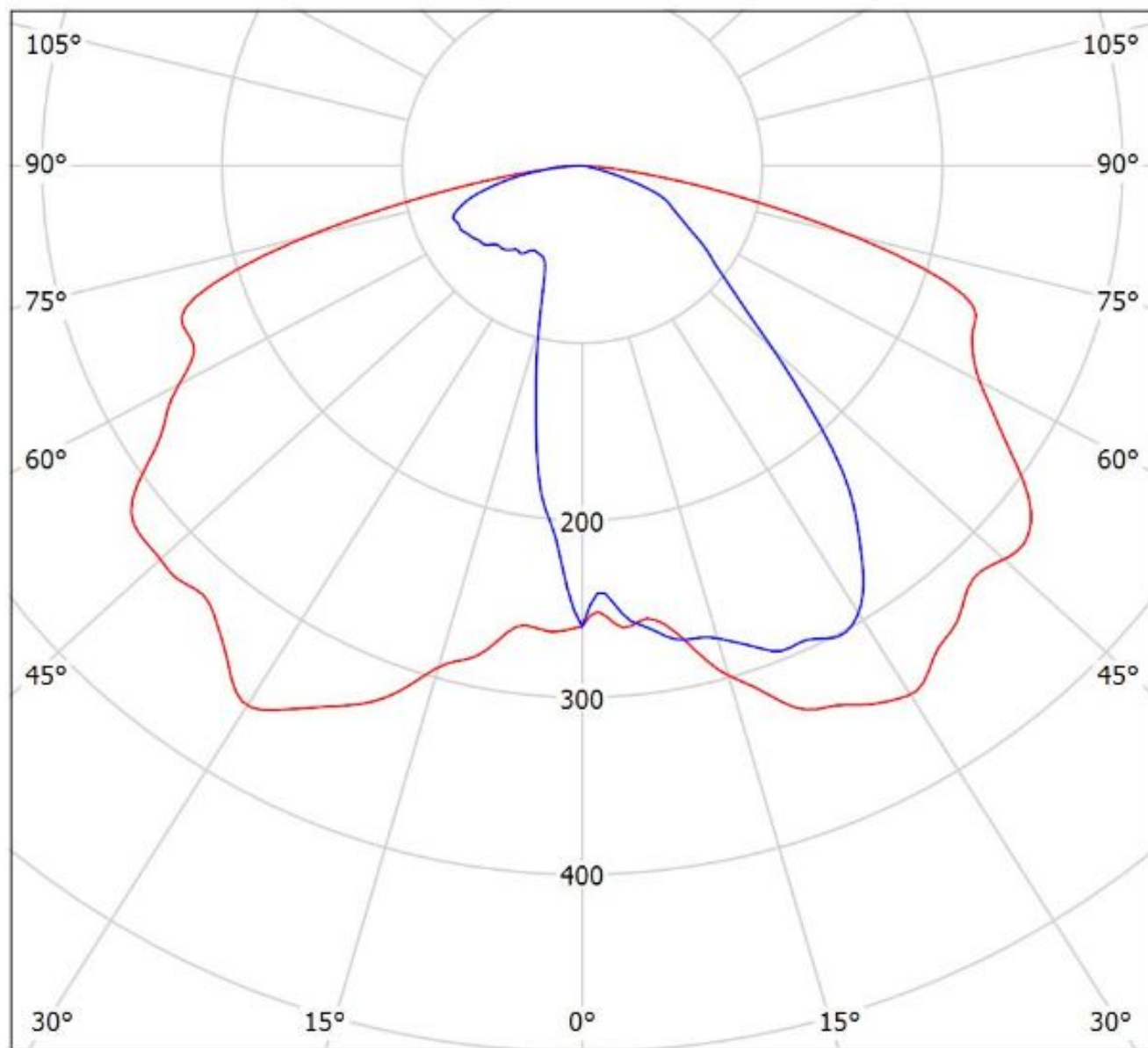

cd/klm

— C0 - C180 — C90 - C270

$\eta = 89\%$

Luminaire: Ledil Oy FN13323_STELLA-A+_B+W 433 TypL1_BRIDGELUX_V13_Gen7_SIMULATED
Lamps: 1 x BRIDGELUX V13 Gen7

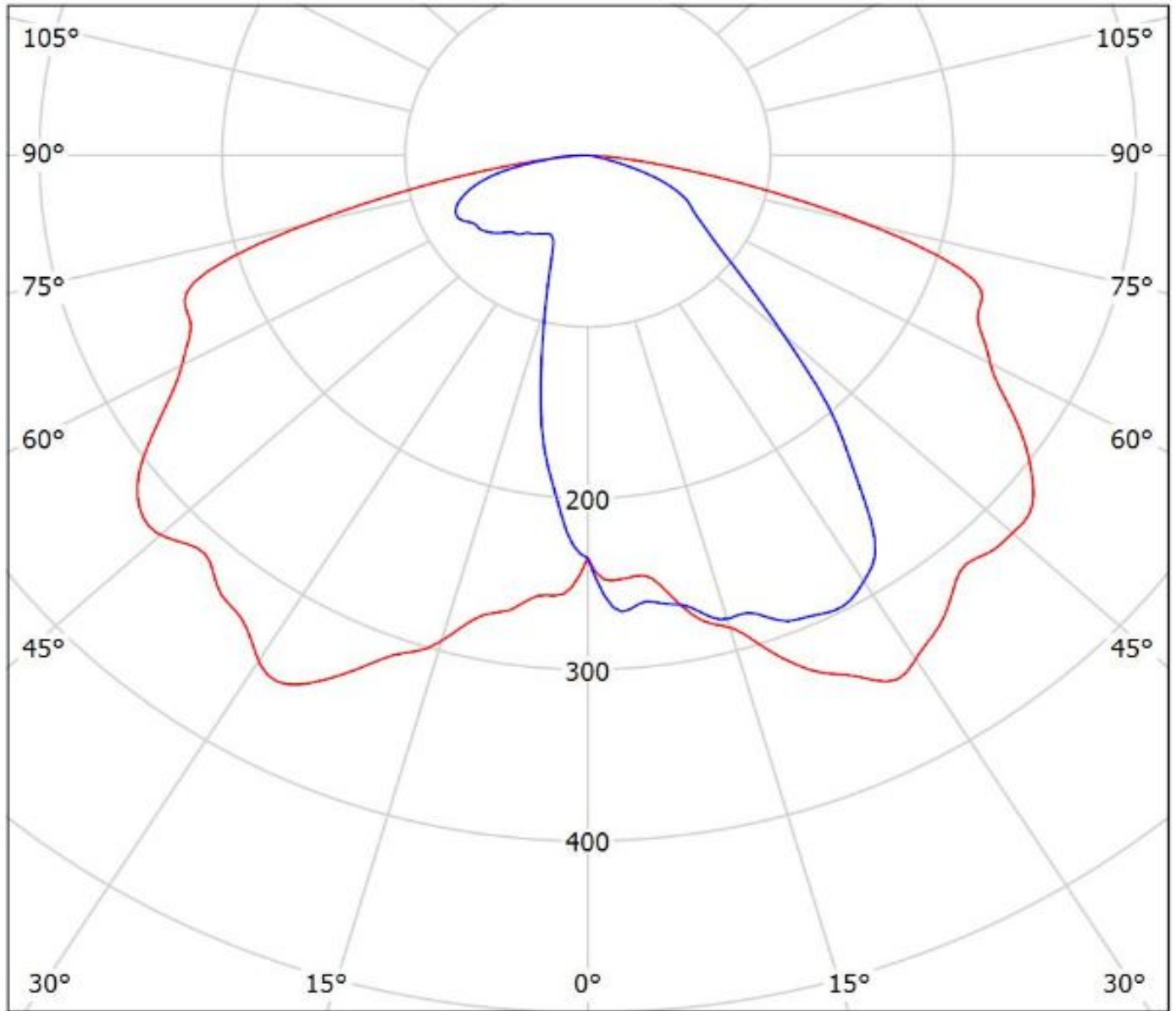

cd/klm

— C0 - C180 — C90 - C270

$\eta = 89\%$

Luminaire: Ledil Oy FN13323_STELLA-A_BRIDGELUX_V18_Gen7_SIMULATED
Lamps: 1 x BRIDGELUX V18 Gen7

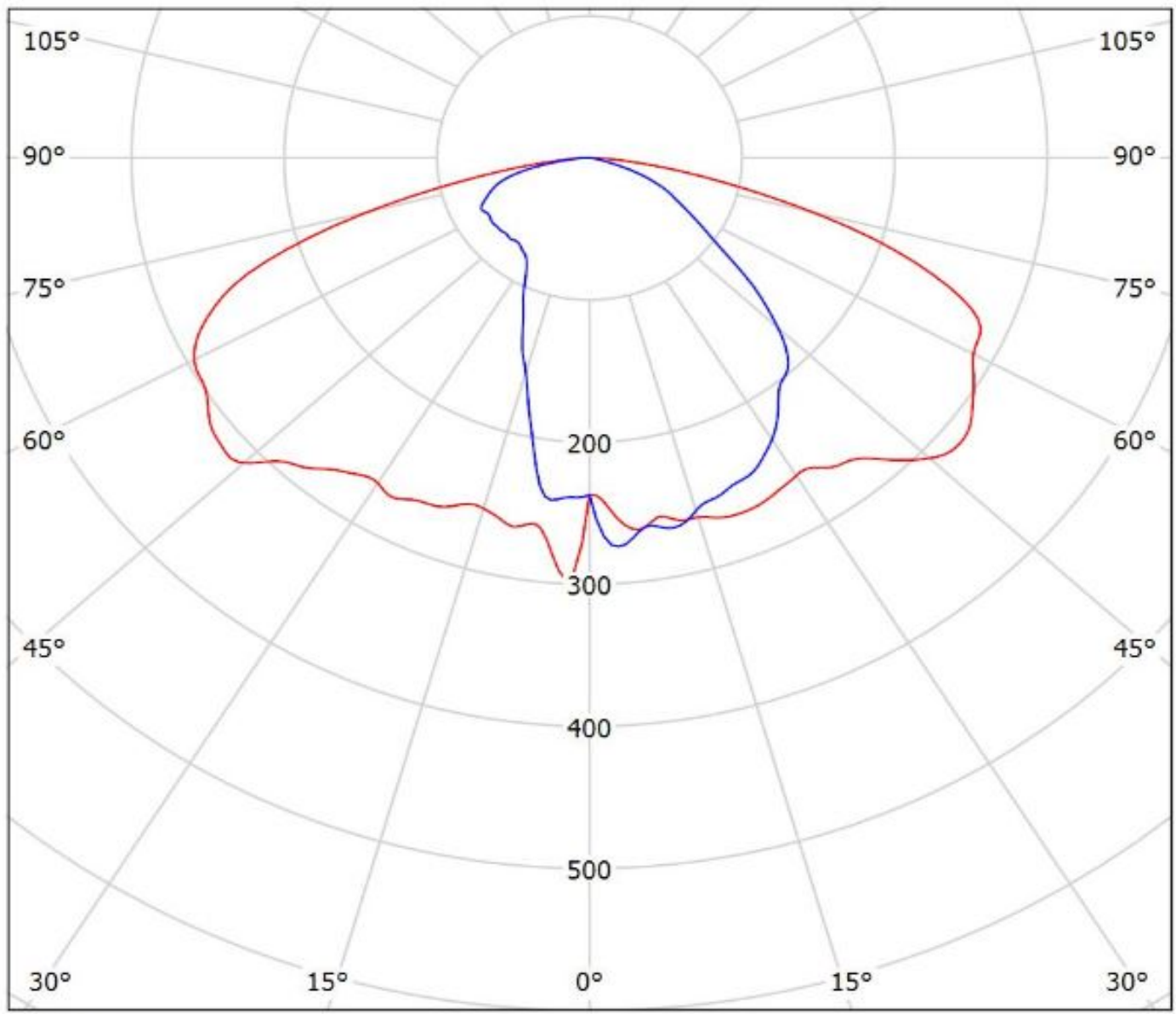

cd/klm
— C0 - C180 — C90 - C270

$\eta = 88\%$

Luminaire: LEDiL Oy FN13323_STELLA-A_(CLL030) Eff. 92%

Lamps: 1 x Citizen_CLL030_(CLL030-1205A5-303H1A7) 690lm@250mA CCT=3000K P=9W I=250mA

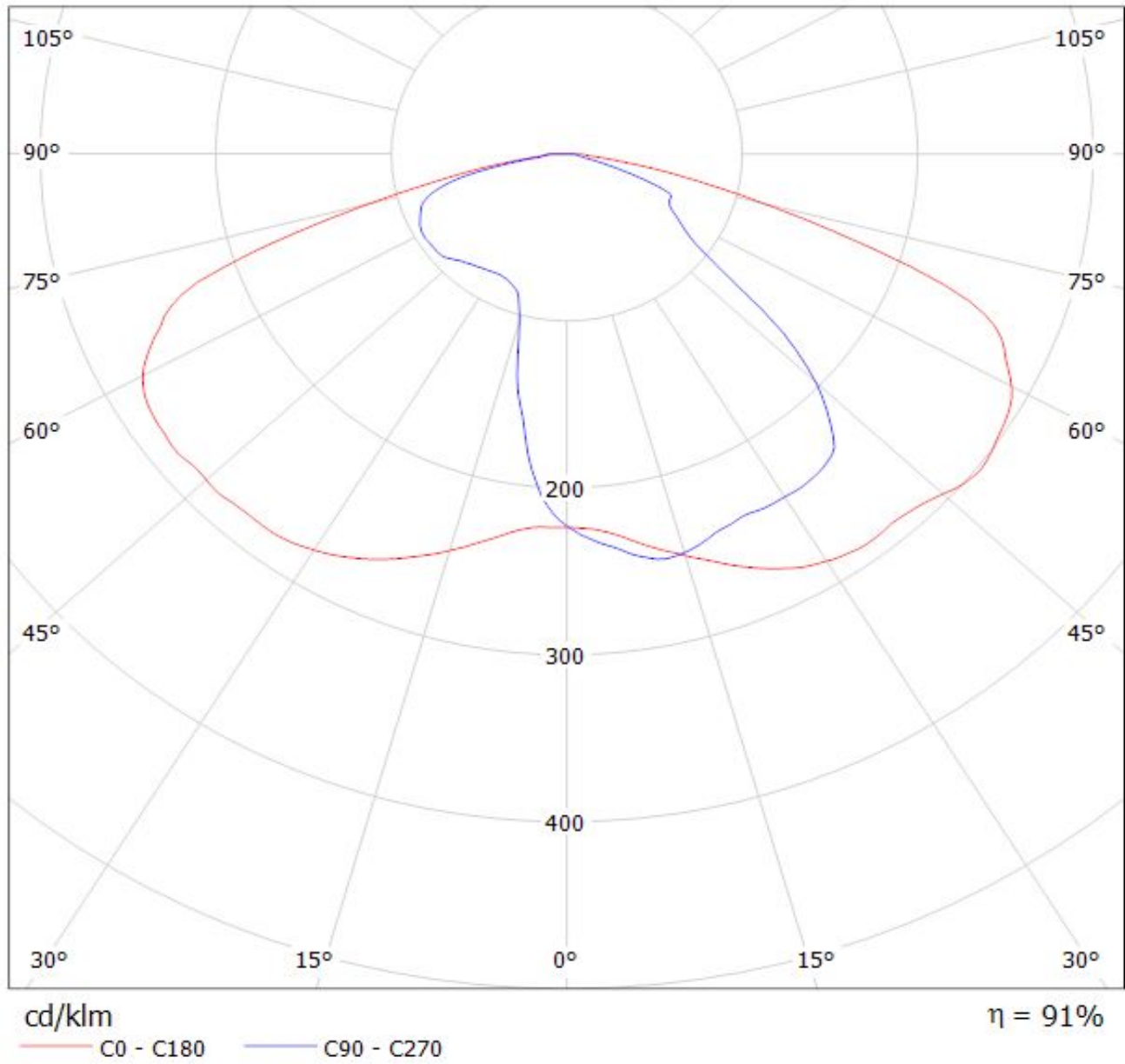

Luminaire: Ledil FN13323_STELLA-A_(CLU710)

Lamps: 1 x CITIZEN_CLU710_(CLU710-1204B8-273M2G1)_1212.66lm@250mA_P=8.5W_I=0.25A

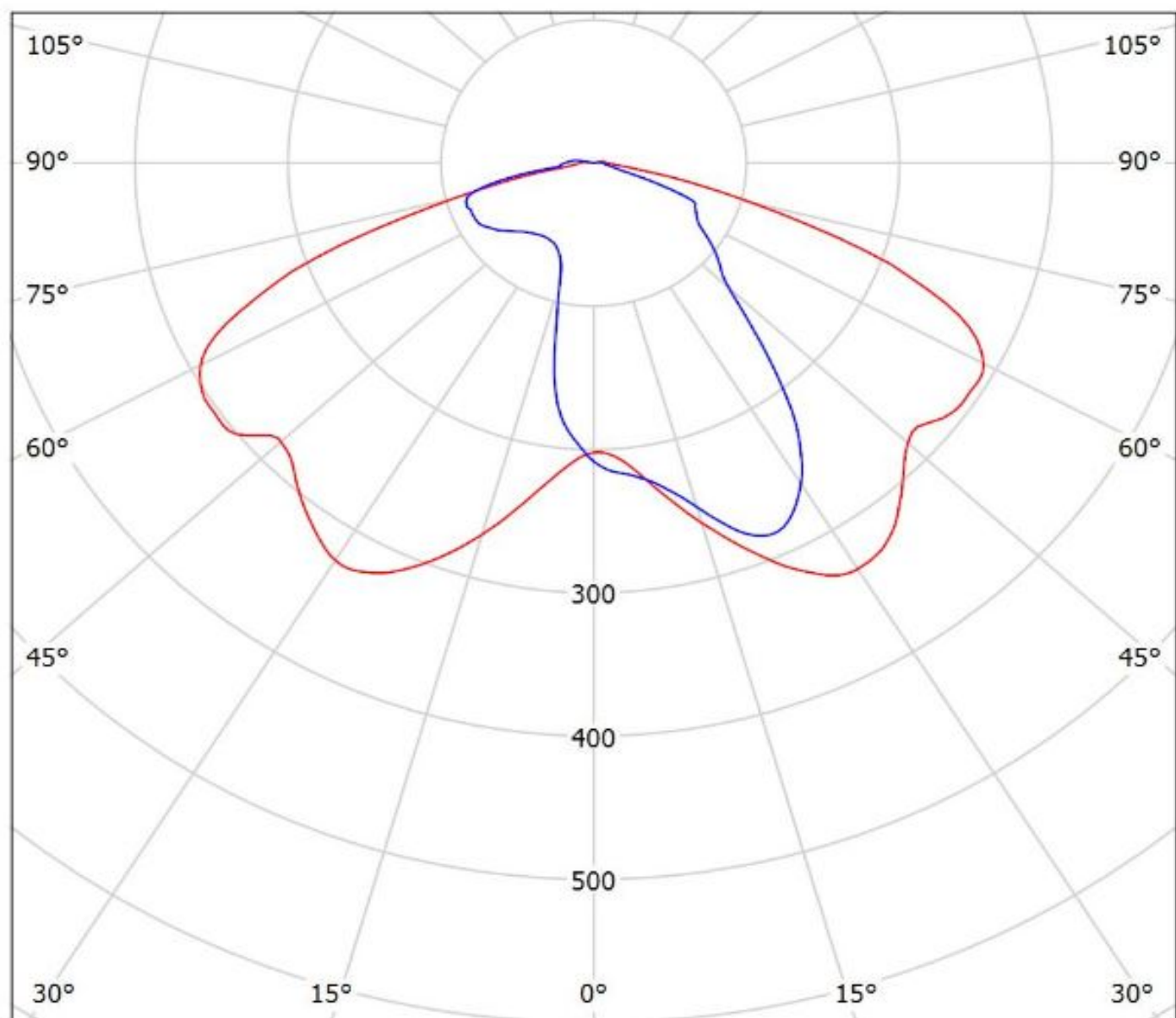

cd/klm

— C0 - C180 — C90 - C270

$\eta = 89\%$

Ledil FN13323_STELLA-A_(CLU720) / LDC (Polar)

Luminaire: Ledil FN13323_STELLA-A_(CLU720)
Lamps: 1 x CITIZEN_CLU720_(CLU720-1206B8-273M2)
_1298.17lm@250mA_CCT=2700K_P=8.3W_I=0.25A

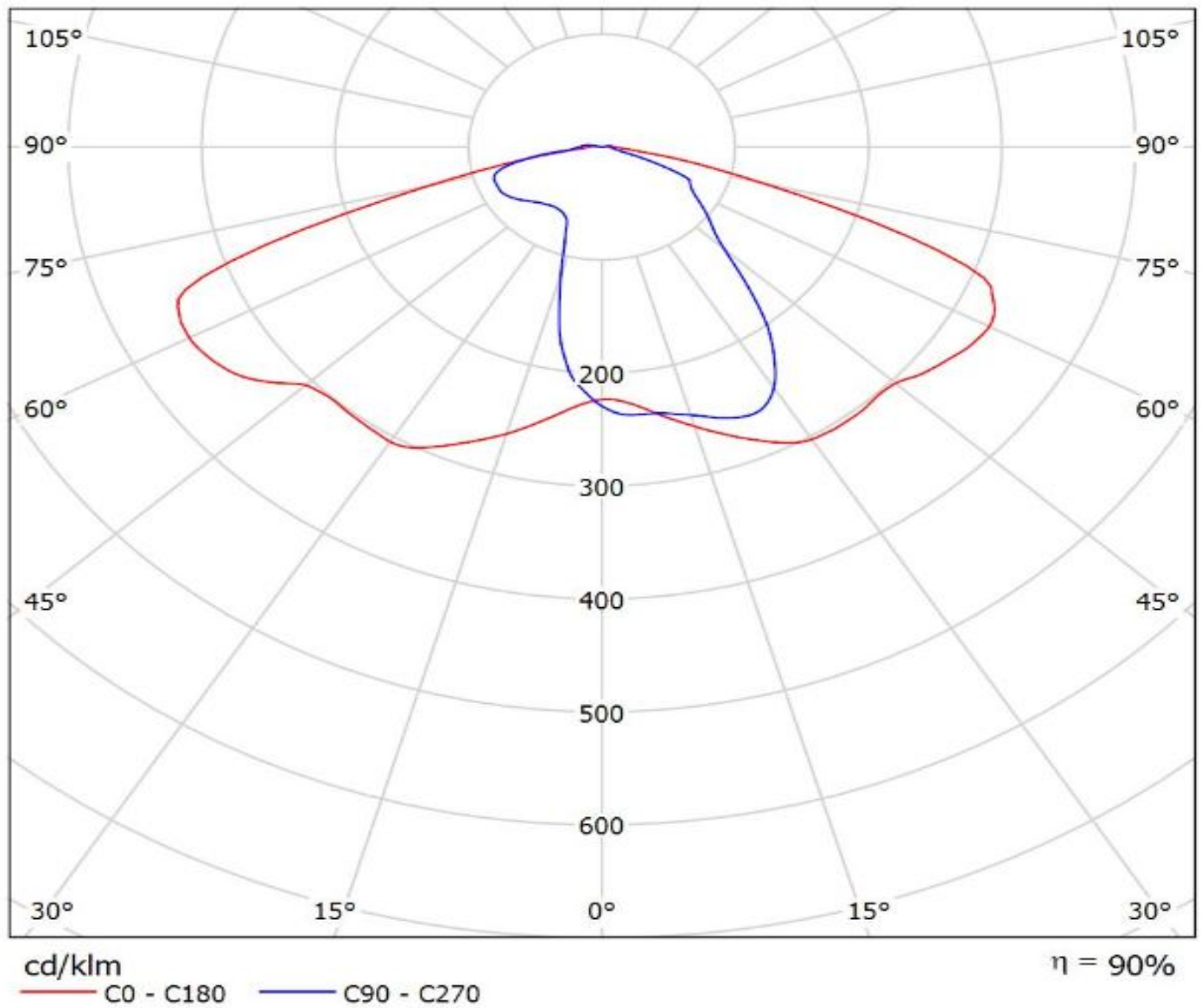

Luminaire: Ledil FN13323_STELLA-A_(CLU700)_(434_Typ_L1)

Lamps: 1 x Citizen_CLU700_(CLU700-1002B8-273M2G1)_(434_Typ_L1)_390.128lm@100mA_P=3W_I=0.10A

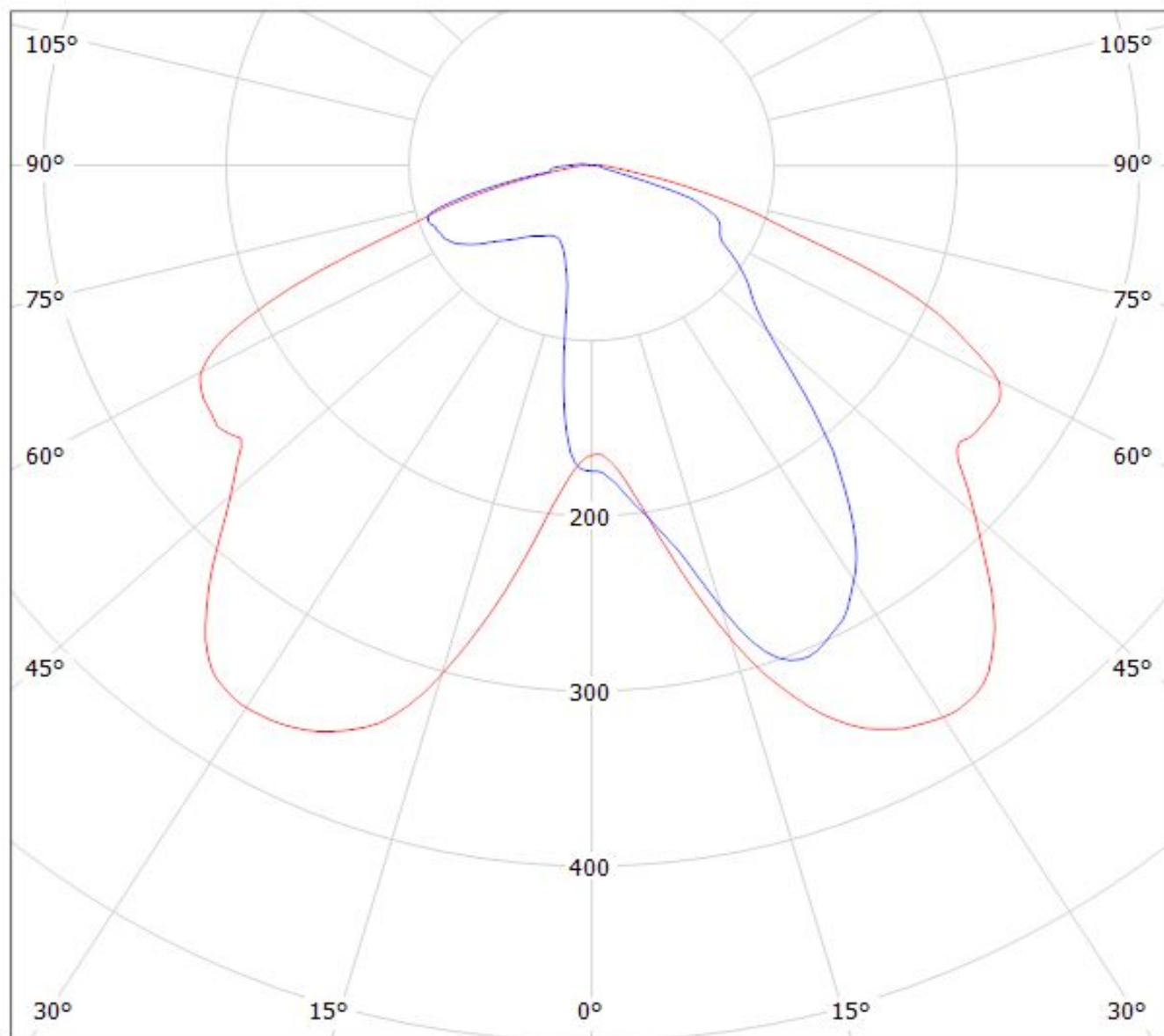

cd/klm

— C0 - C180

— C90 - C270

$\eta = 89\%$

Luminaire: Ledil FN13323_STELLA-A_(CLU720)_(433_Typ_L1)

Lamps: 1 x Citizen_CLU720_(CLU720-1206B8-273M2G1)_1204.28lm@250mA_P=8.25W_I=0.25A

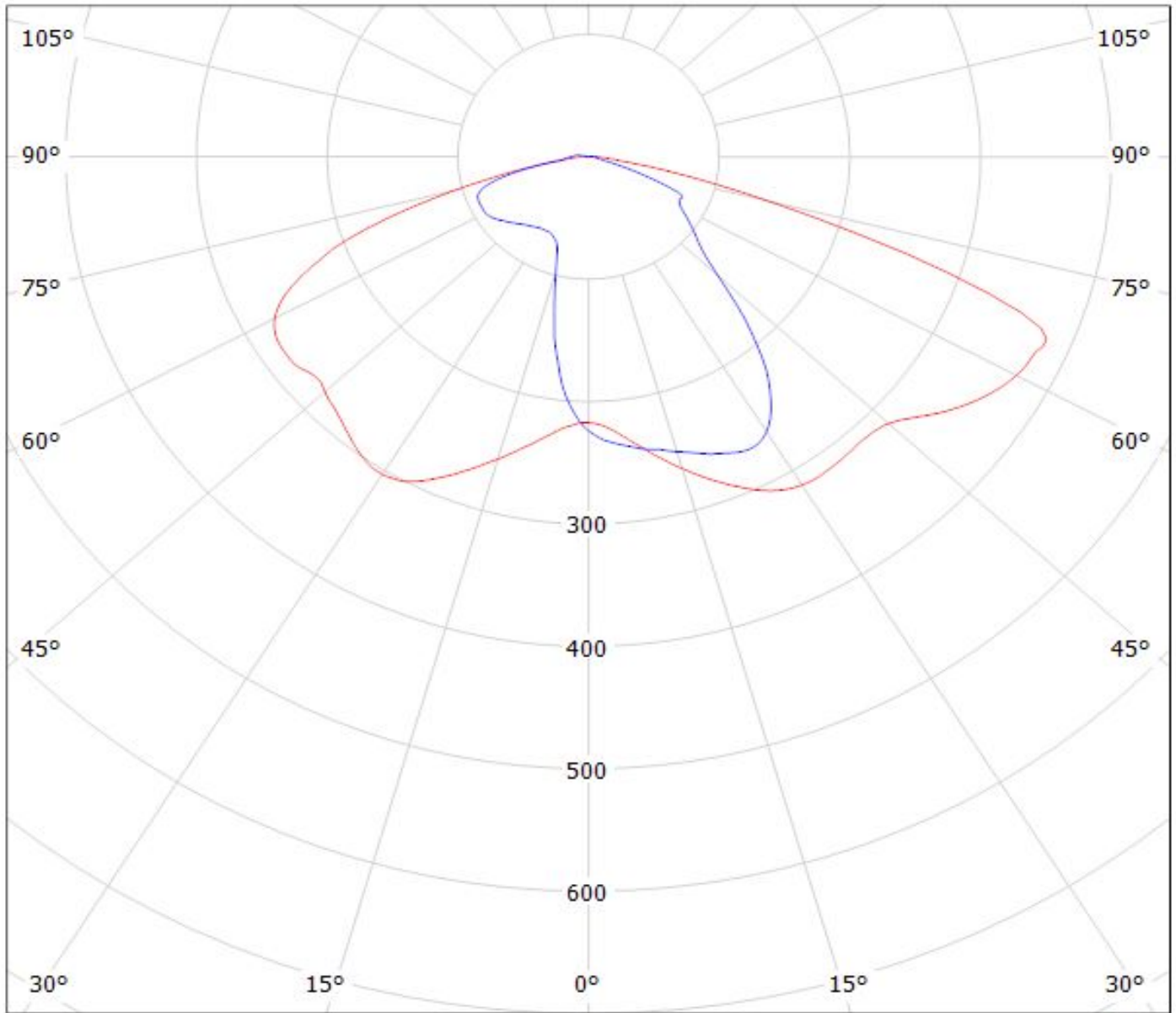

cd/klm

— C0 - C180

— C90 - C270

$\eta = 91\%$

Luminaire: Ledil Oy FN14976_STELLA-DWC2_(CLU028)_SIMULATED
Lamps: 1 x Citizen CLU028-1204C4-303M2K1

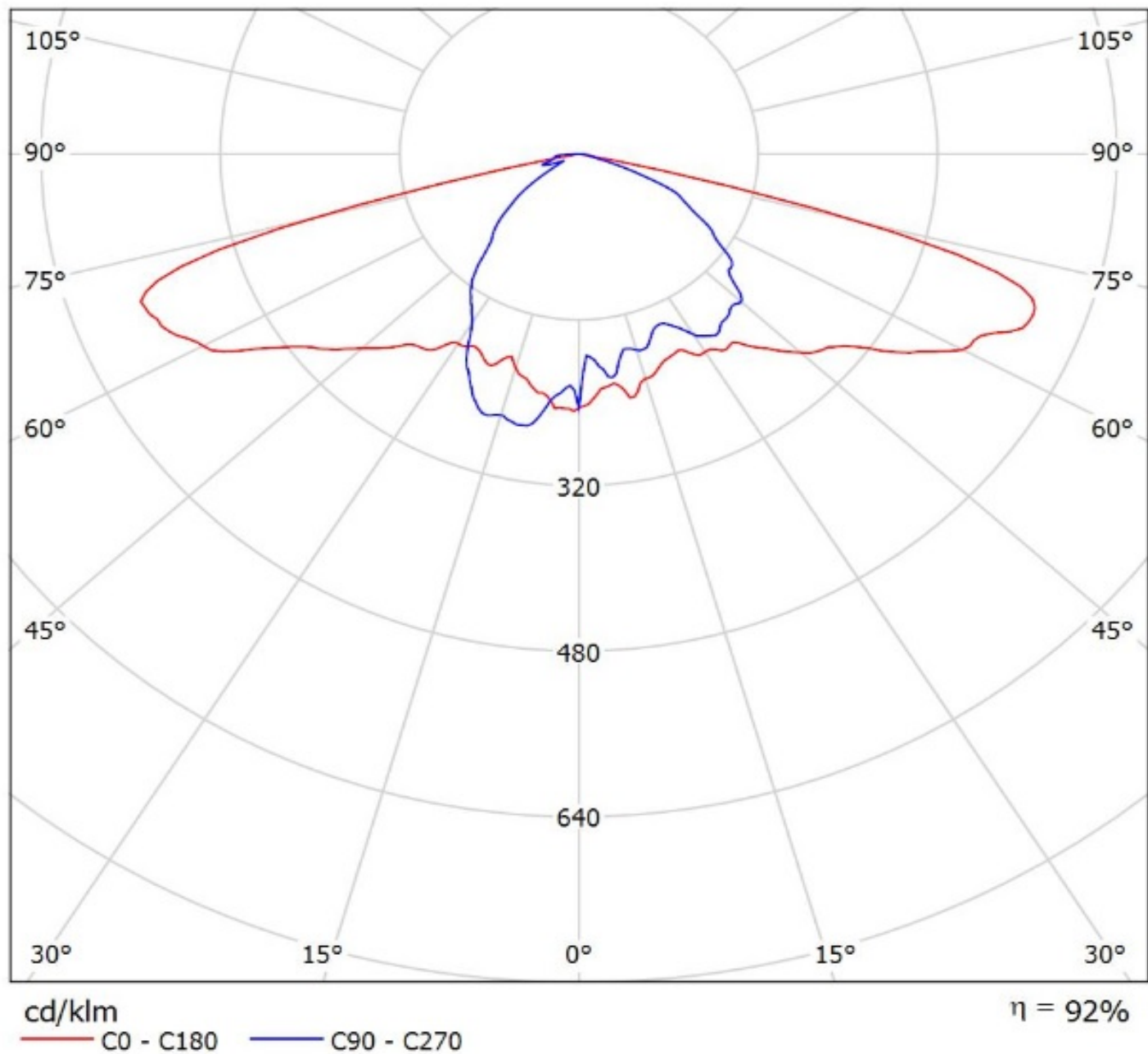

Luminaire: Ledil Oy FN13323_STELLA-A_(CLU038)_SIMULATED
Lamps: 1 x Citizen CLU038

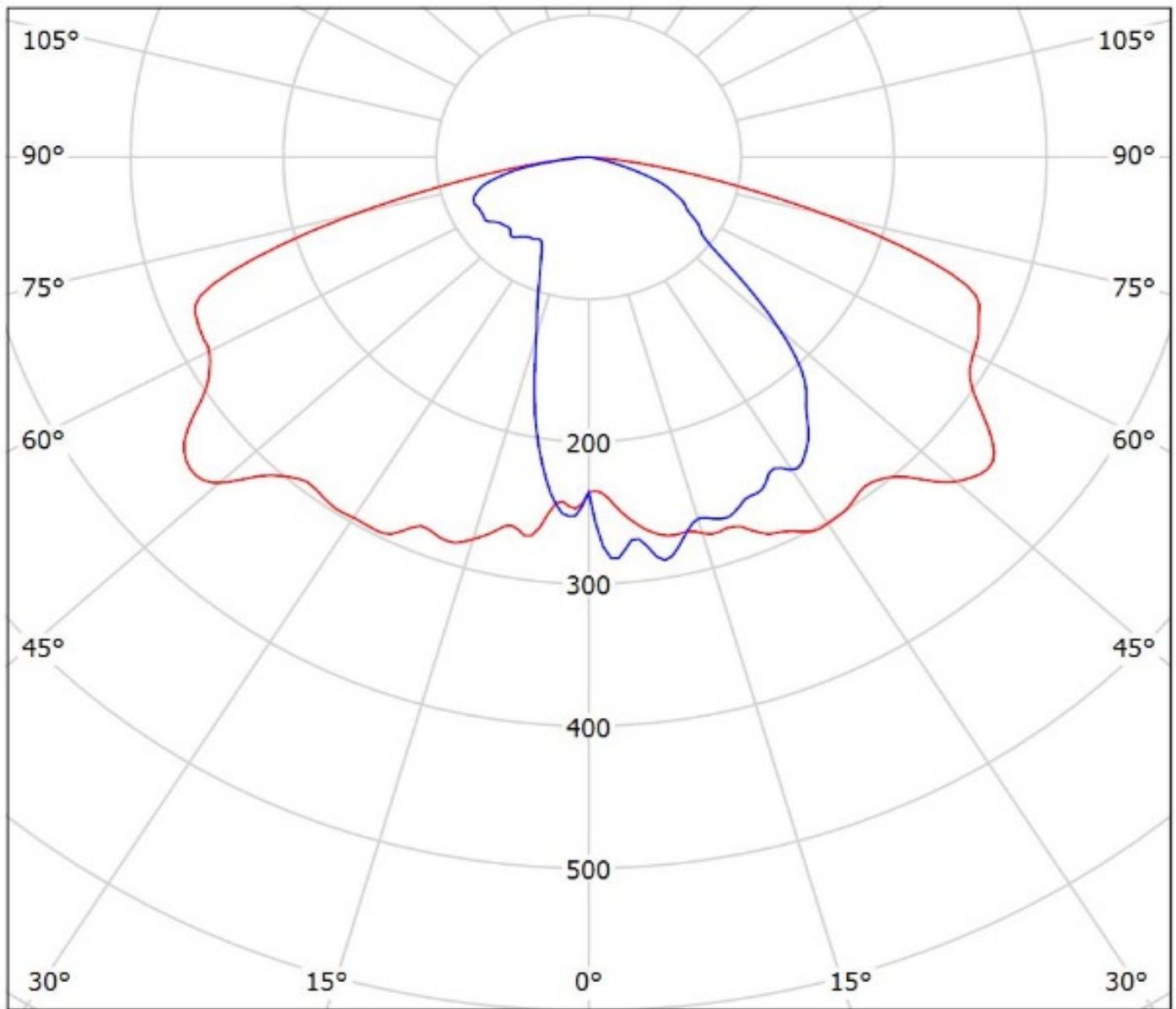

cd/klm

— C0 - C180 — C90 - C270

$\eta = 90\%$

Luminaire: LEDiL Oy FN13323_STELLA-A_(CXA25) Eff. 93%

Lamps: 1 x CREE_CXA25 (CXA2530-7C0-T2-N0H)1100lm@250mA CCT=3000K P=8W I=250mA

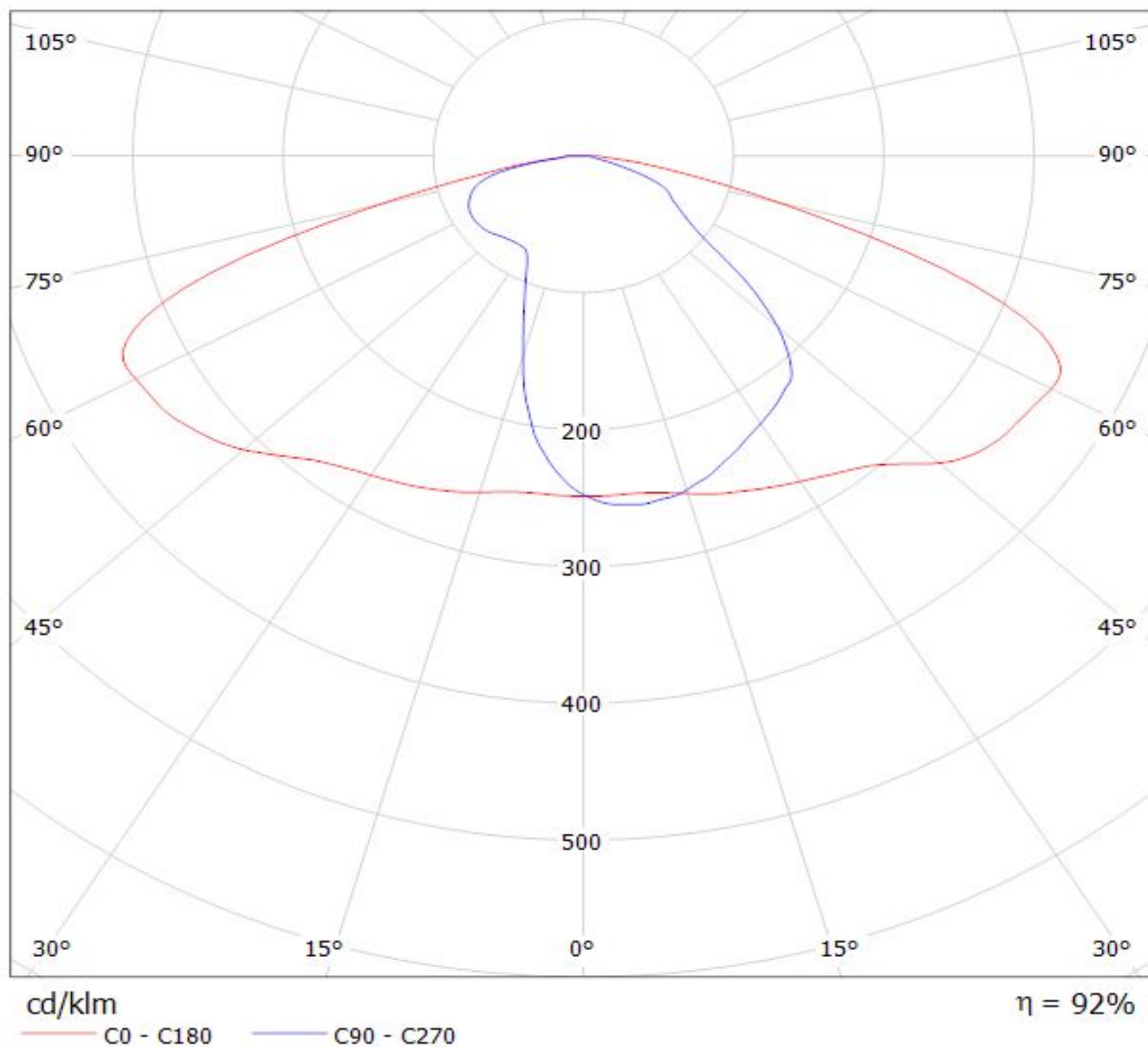

Luminaire: LEDiL Oy FN13323_STELLA-A_(CXA1507) Eff: 92%

Lamps: 1 x Cree_CXA1507_(CXA1507-30F-F2-N0A-0000) 220lm@50mA CCT=3000K P=2W I=50mA

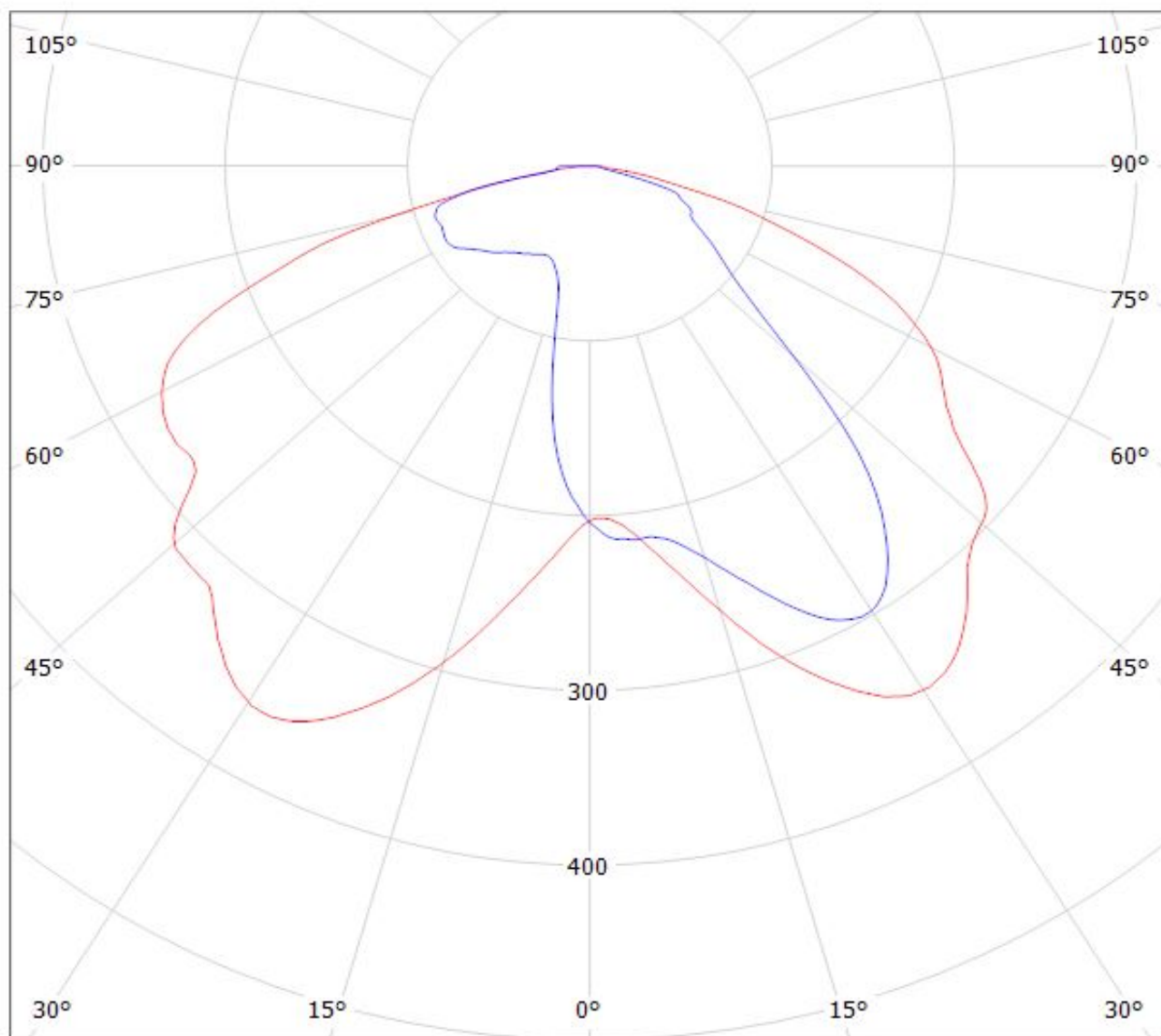

cd/klm

— C0 - C180

— C90 - C270

$\eta = 91\%$

LEDiL Oy FN13323_STELLA-A_(CXA1816) Eff.87.1% / LDC (Polar)

Luminaire: LEDiL Oy FN13323_STELLA-A_(CXA1816) Eff.87.1%

Lamps: 1 x CREE_CXA1816_1075.33lm@250mA_P=8.66981W_I=249.8mA

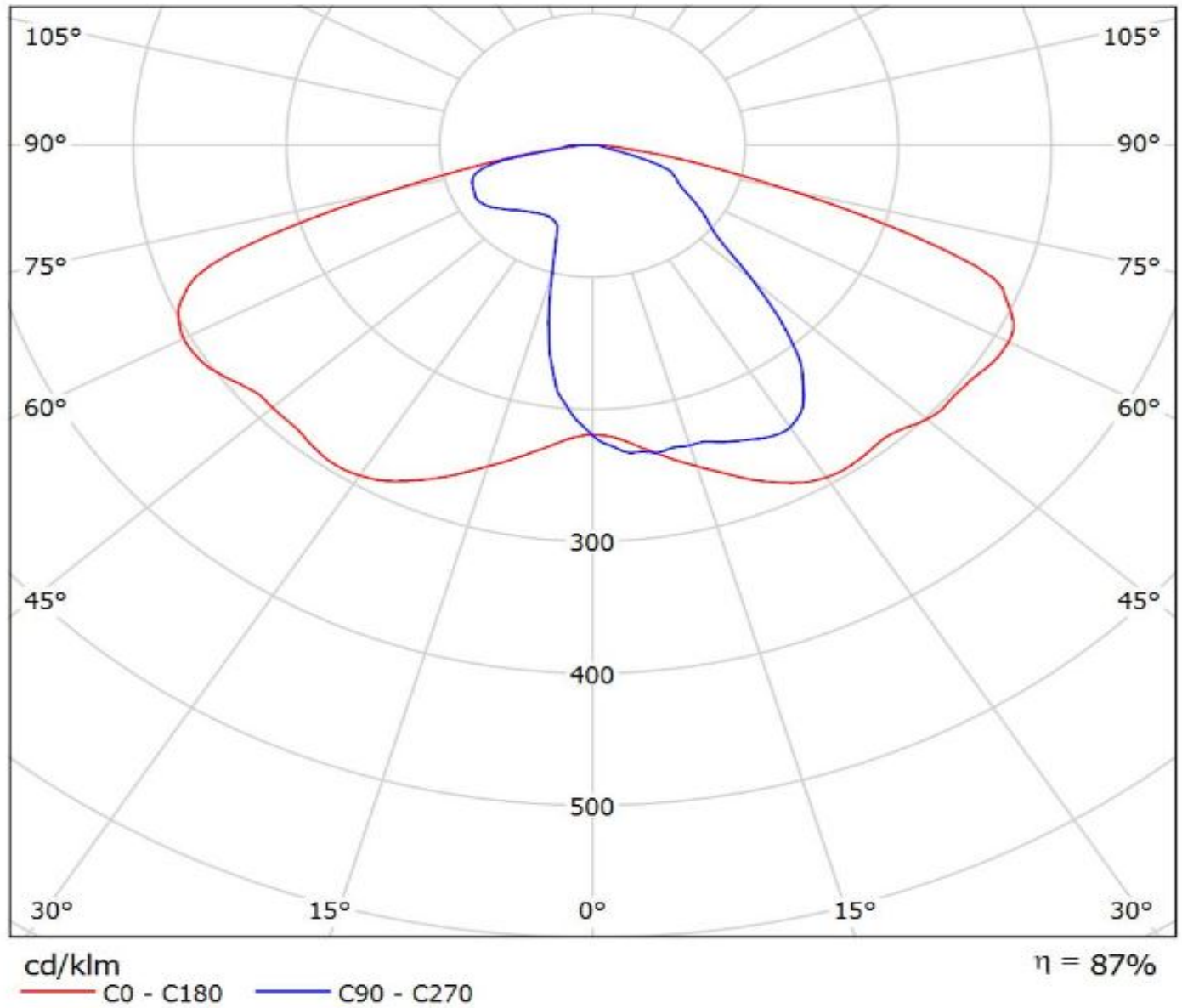

Ledil FN13323_STELLA-A_(CXA1850) / LDC (Polar)

Luminaire: Ledil FN13323_STELLA-A_(CXA1850)

Lamps: 1 x CREE_CXA1850_(CXA1850-30F-T4-N0Y-00001)

_837.004lm@250mA_CCT=3000K_P=8.24W_I=0.25A

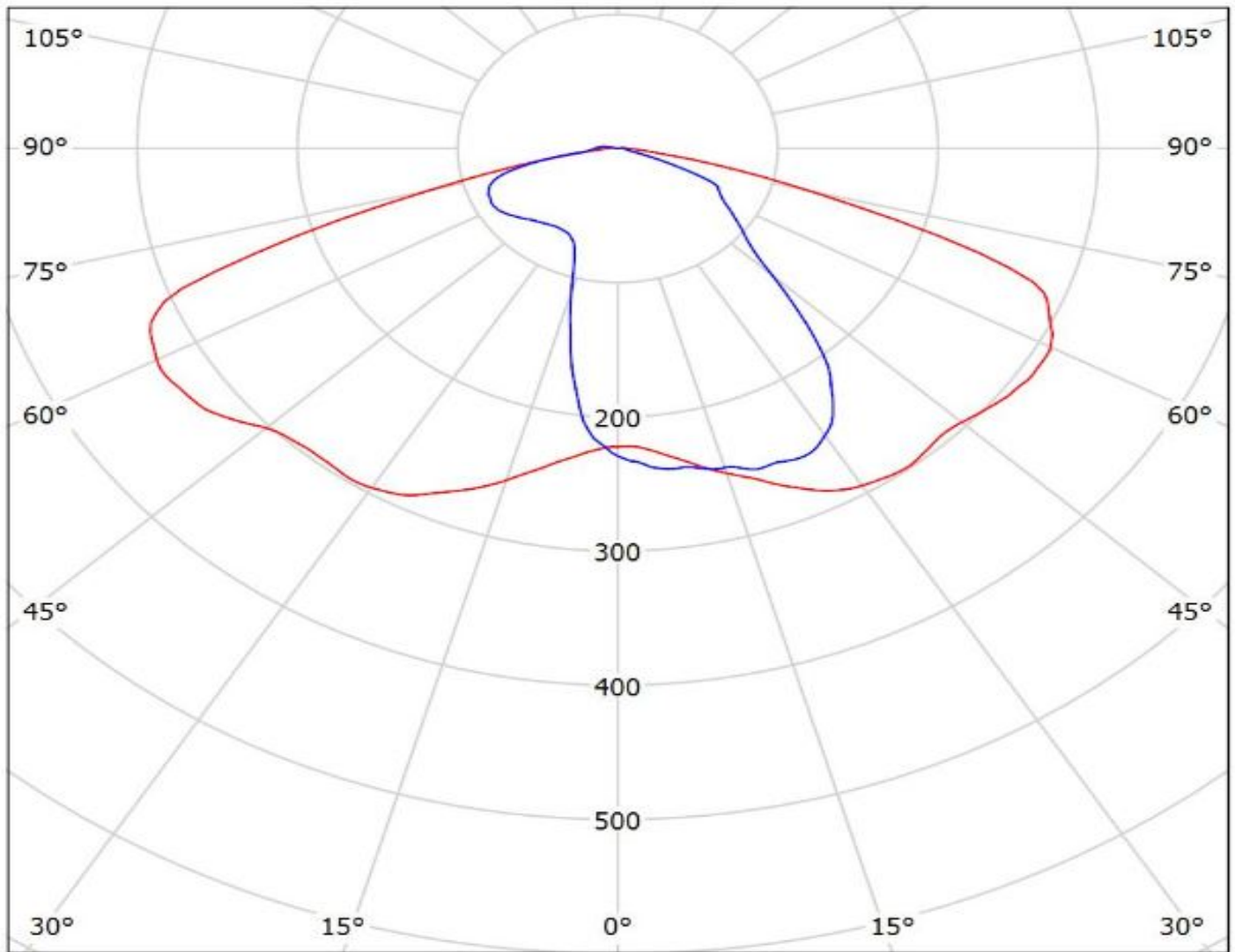

cd/klm

— C0 - C180 — C90 - C270

$\eta = 89\%$

Luminaire: Ledil FN13323_STELLA-A_(CXA1520)_(441_Typ_L1) Citizen_CXA1520_(CXA1520-30F-N4-N0H-00001)_(441_Typ_L1)_1038.48lm@250mA_P=8.8025W_I=0.25A

Lamps: 1 x Citizen_CXA1520_(CXA1520-30F-N4-N0H-00001)_(441_Typ_L1)
_1038.48lm@250mA_P=8.8025W_I=0.25A

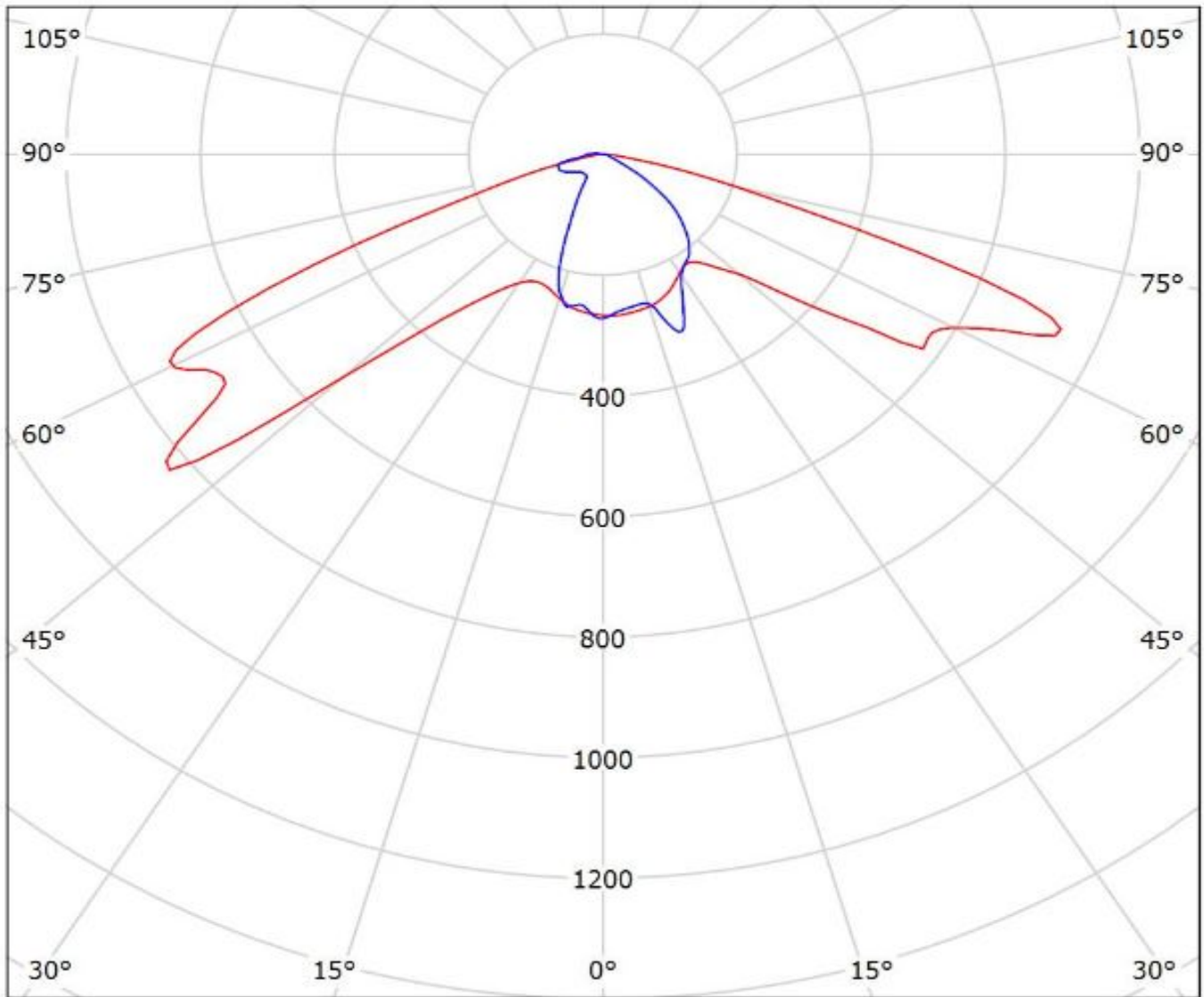

cd/klm

— C0 - C180 — C90 - C270

$\eta = 92\%$

Luminaire: LEDiL Oy FN13323_STELLA-A (Luxeon_CoB_1203)_ (438_Typ_L1)

Lamps: 1 x Luxeon_CoB_1203_(LHC1-3080-1203)_ (438_Typ_L1)_ 1005.18lm@250mA_P=8.69829W_I=0.2498A

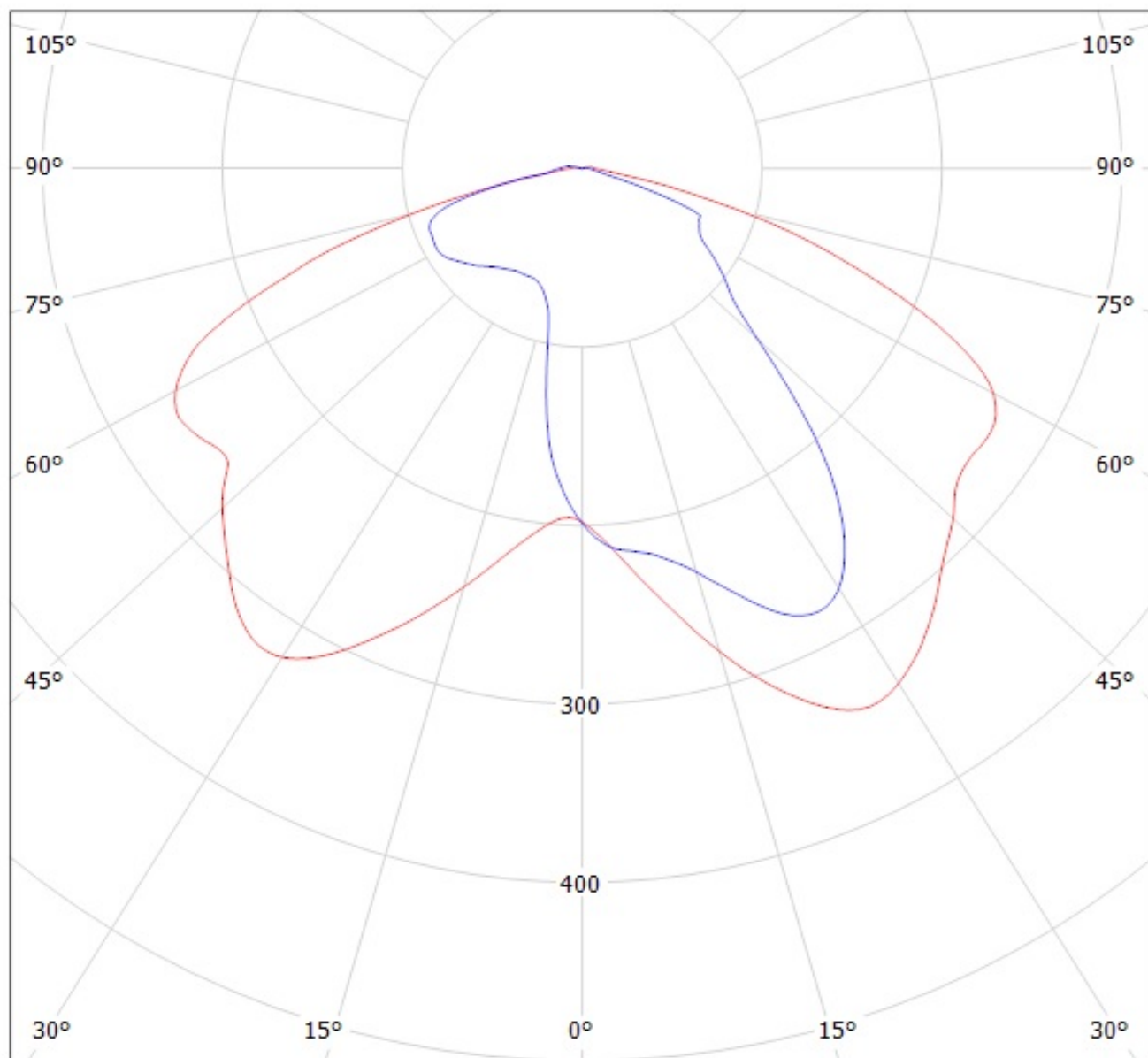

cd/klm

— C0 - C180

— C90 - C270

$\eta = 88\%$

Luminaire: LEDiL Oy FN13323_STELLA-A_(CXM-18) Eff.89.2%
Lamps: 1 x LUMINUS_XNOVA_CXM-18_897.842lm@250mA_P=8.12425W_I=249.9mA

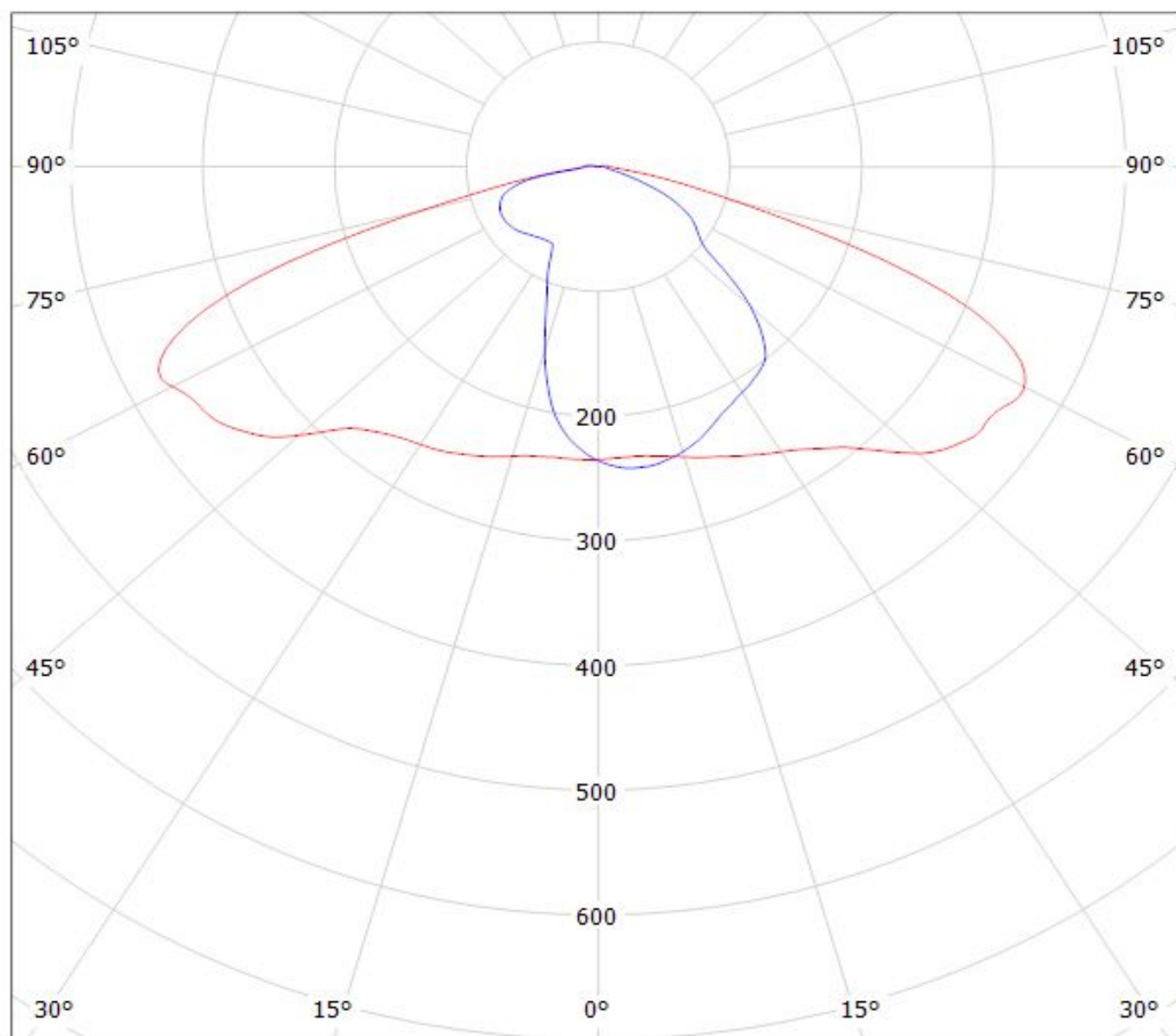

cd/klm

— C0 - C180 — C90 - C270

$\eta = 89\%$

Luminaire: LEDiL Oy FN13323_STELLA-A_(CXM-14)
Lamps: 1 x LUMINUS_XNOVA_CXM-14_(AC00)
_1064.17lm@250mA_CCT=3133K_P=8.33558W_I=249.8mA

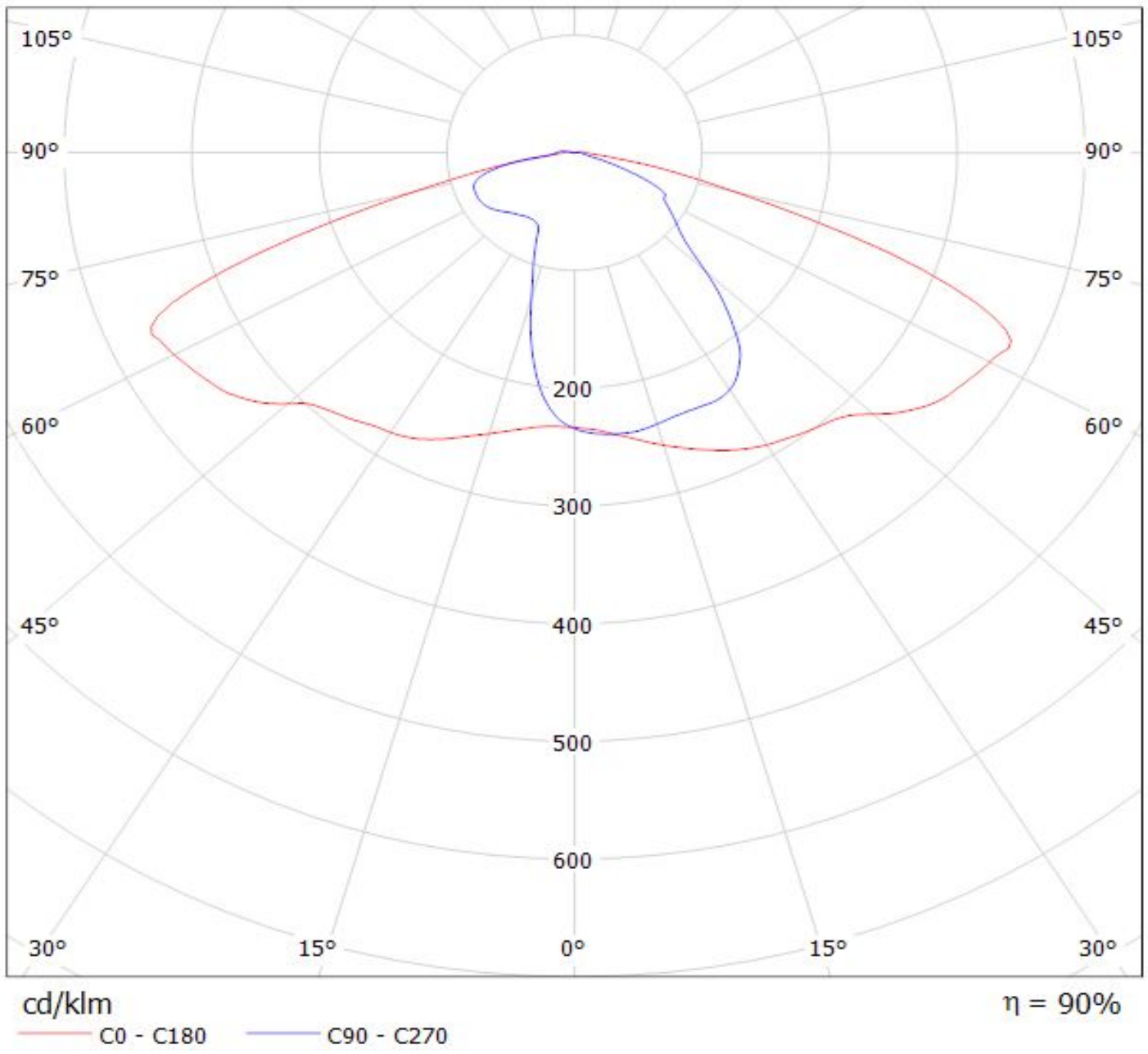

Ledil FN13323_STELLA-A_(NFCLL036B) / LDC (Polar)

Luminaire: Ledil FN13323_STELLA-A_(NFCLL036B)
Lamps: 1 x Nichia_NFCLL036B_(SM403J1300R8000)
_563.488lm@100mA_CCT=4000K_P=3.35W_I=0.100A

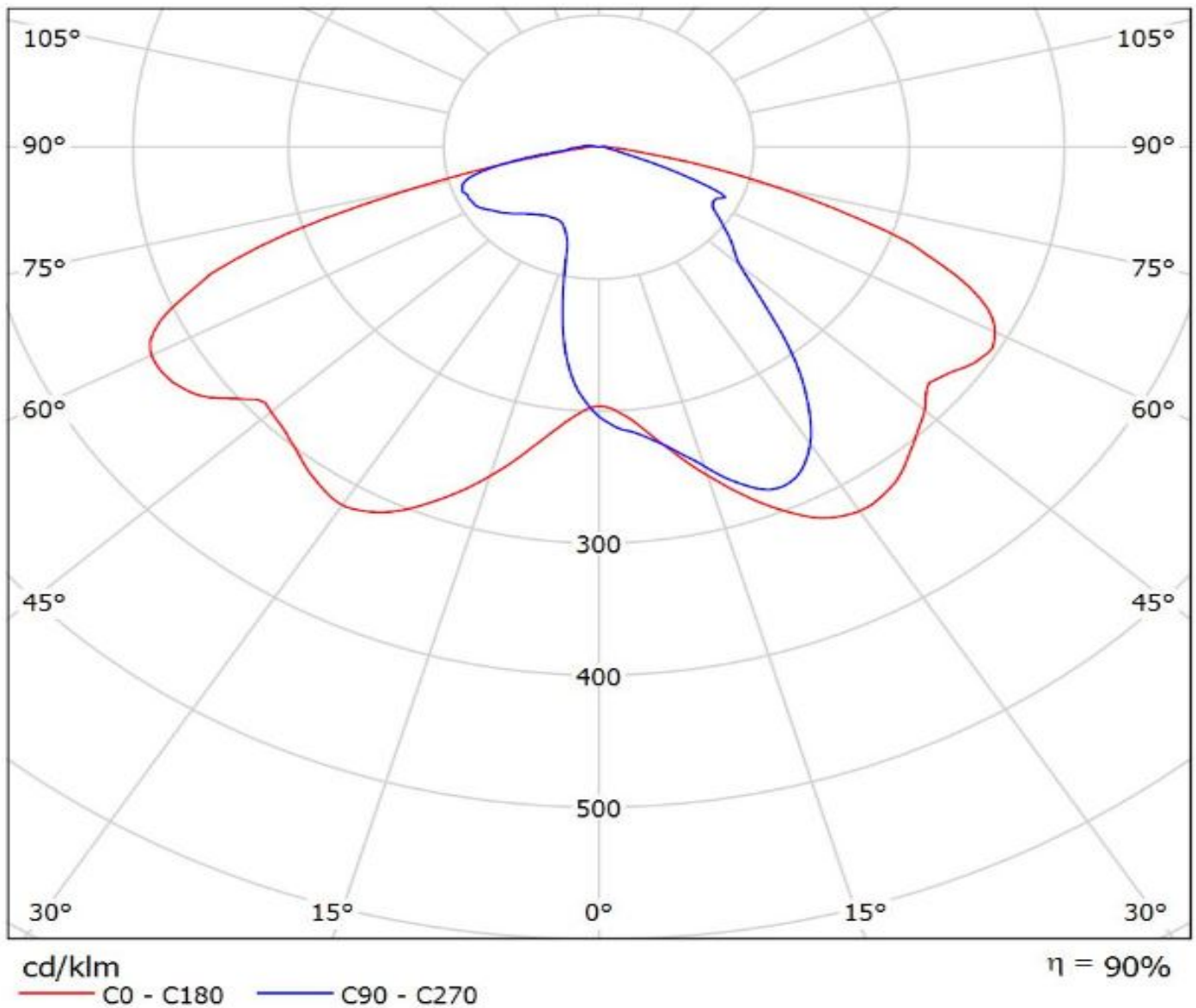

Ledil FN13323_STELLA-A_(NFCLL060B) / LDC (Polar)

Luminaire: Ledil FN13323_STELLA-A_(NFCLL060B)

Lamps: 1 x Nichia_NFCLL060B_(sm406G2450R8000)_1368.94lm@250mA_P=8.5W_I=0.25A

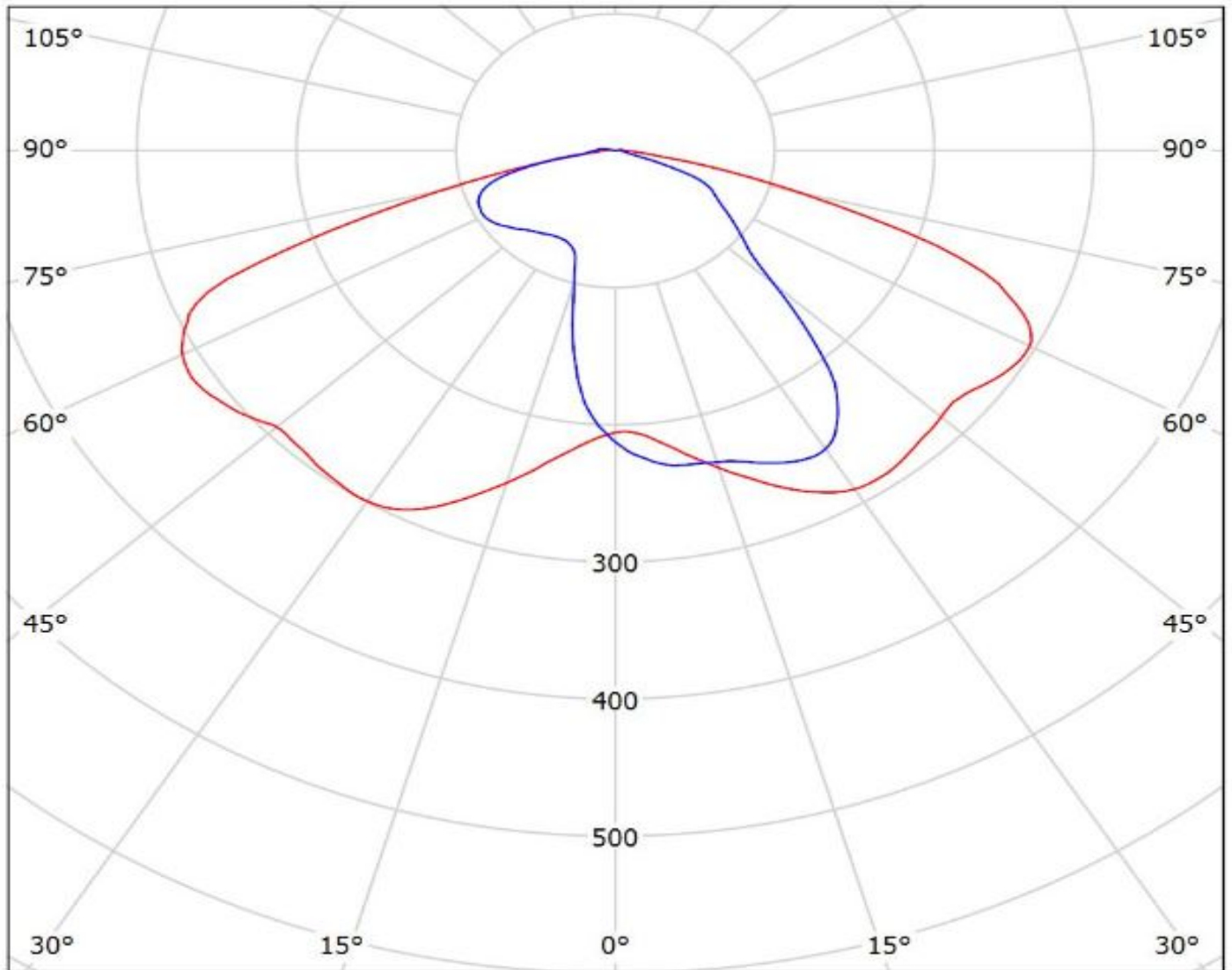

cd/klm

— C0 - C180 — C90 - C270

$\eta = 89\%$

Luminaire: LEDiL Oy FN13323_STELLA-A_(SOLERIQ_S19)

Lamps: 1 x OSRAM_SOLERIQ_S19_(GW_KAHJB1.EM)_1340.3lm@250mA_CCT=3000K_P=10.4491W_I=249.8mA

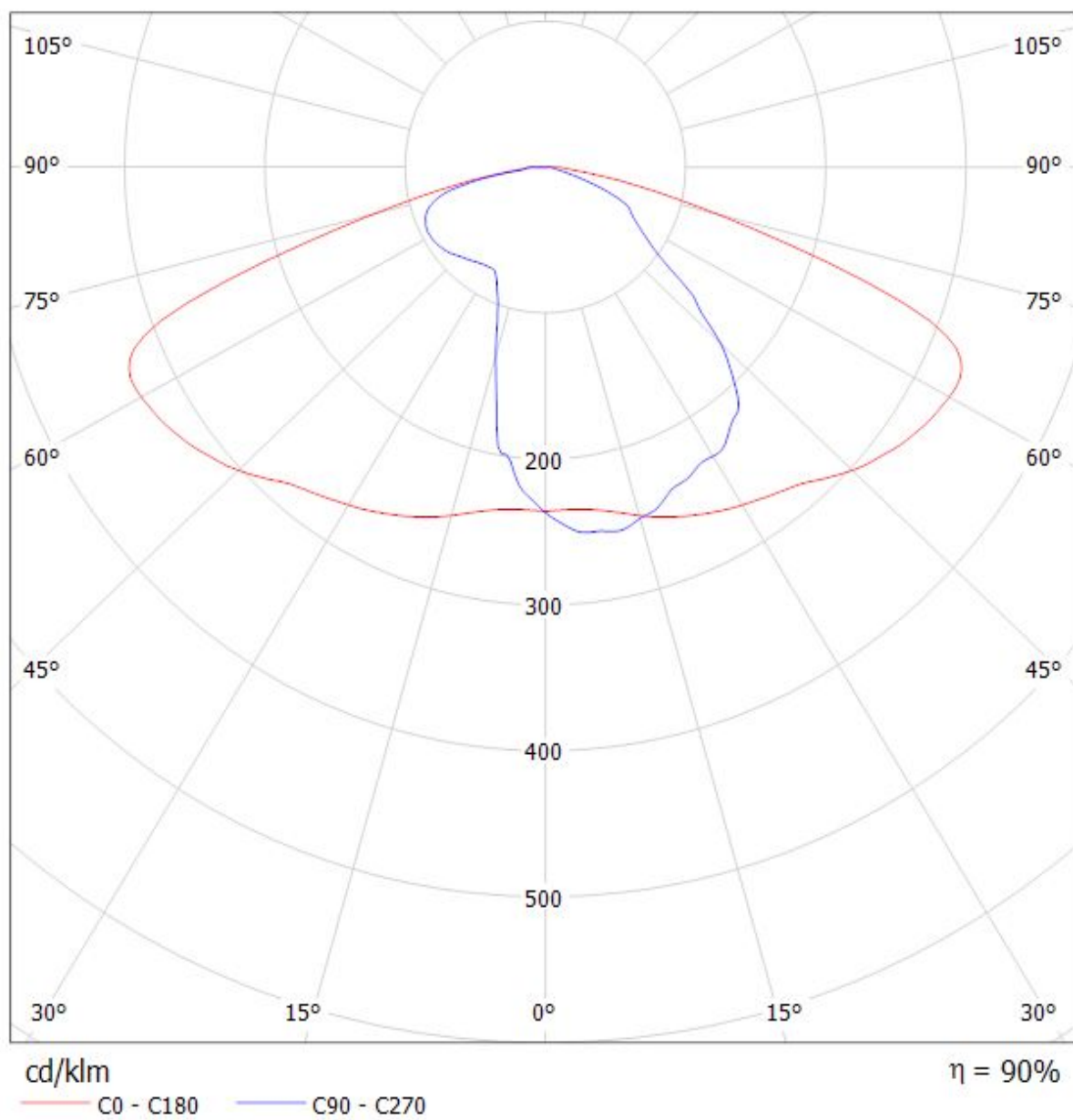

Luminaire: LEDiL Oy FN13323_STELLA-A_(Soleriq_S13)

Lamps: 1 x Osram_Soleriq_S13_802.964lm@250mA_CCT=3125K_P=7.26069W_I=249.8mA

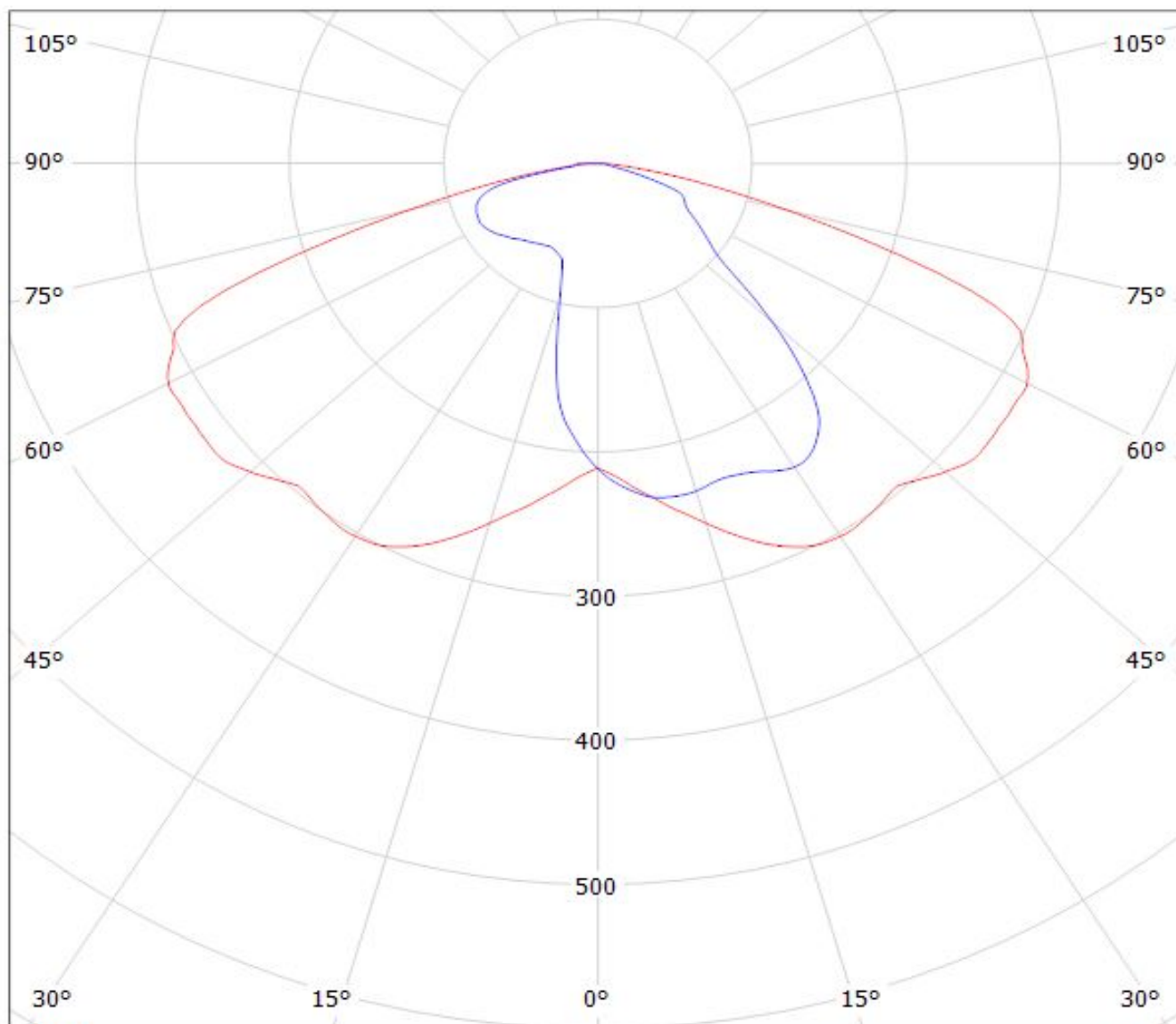

cd/klm

— C0 - C180

— C90 - C270

$\eta = 91\%$

Luminaire: LEDiL Oy FN13323_STELLA-A_(SOLERIQ_P13)

Lamps: 1 x SOLERIQ_P13_(GW_MAGMB1.EM)_929.576lm@250mA_CCT=3500K_P=8.72876W_I=249.8mA

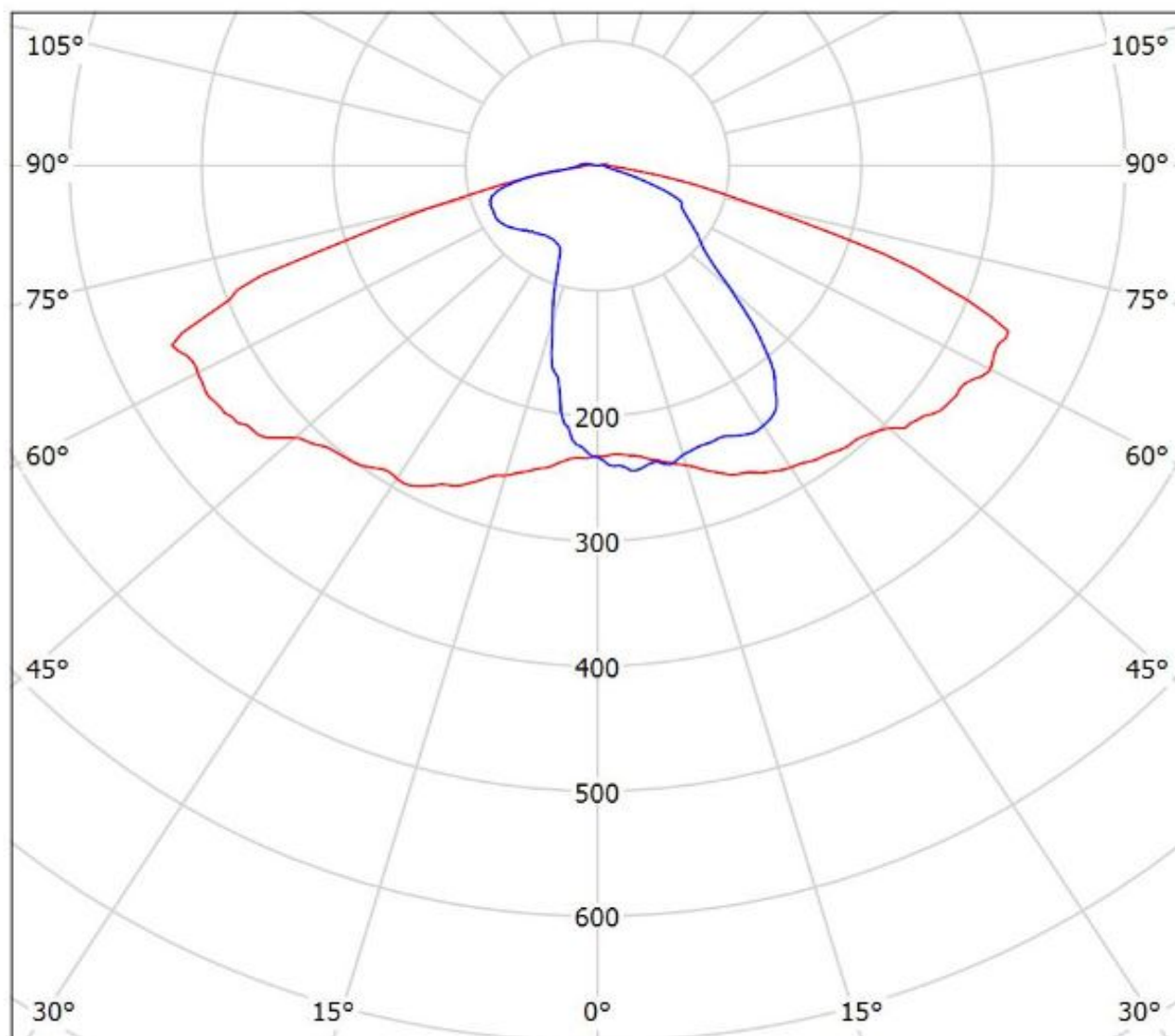

cd/klm

— C0 - C180 — C90 - C270

$\eta = 90\%$

Ledil FN13323_STELLA-A_(P13) / LDC (Polar)

Luminaire: Ledil FN13323_STELLA-A_(P13)
Lamps: 1 x Osram Soleriq P13 (GW MAGMB1.EM)
_929.576lm@250mA_CCT=3500K_P=8.72876W_I=249.8mA

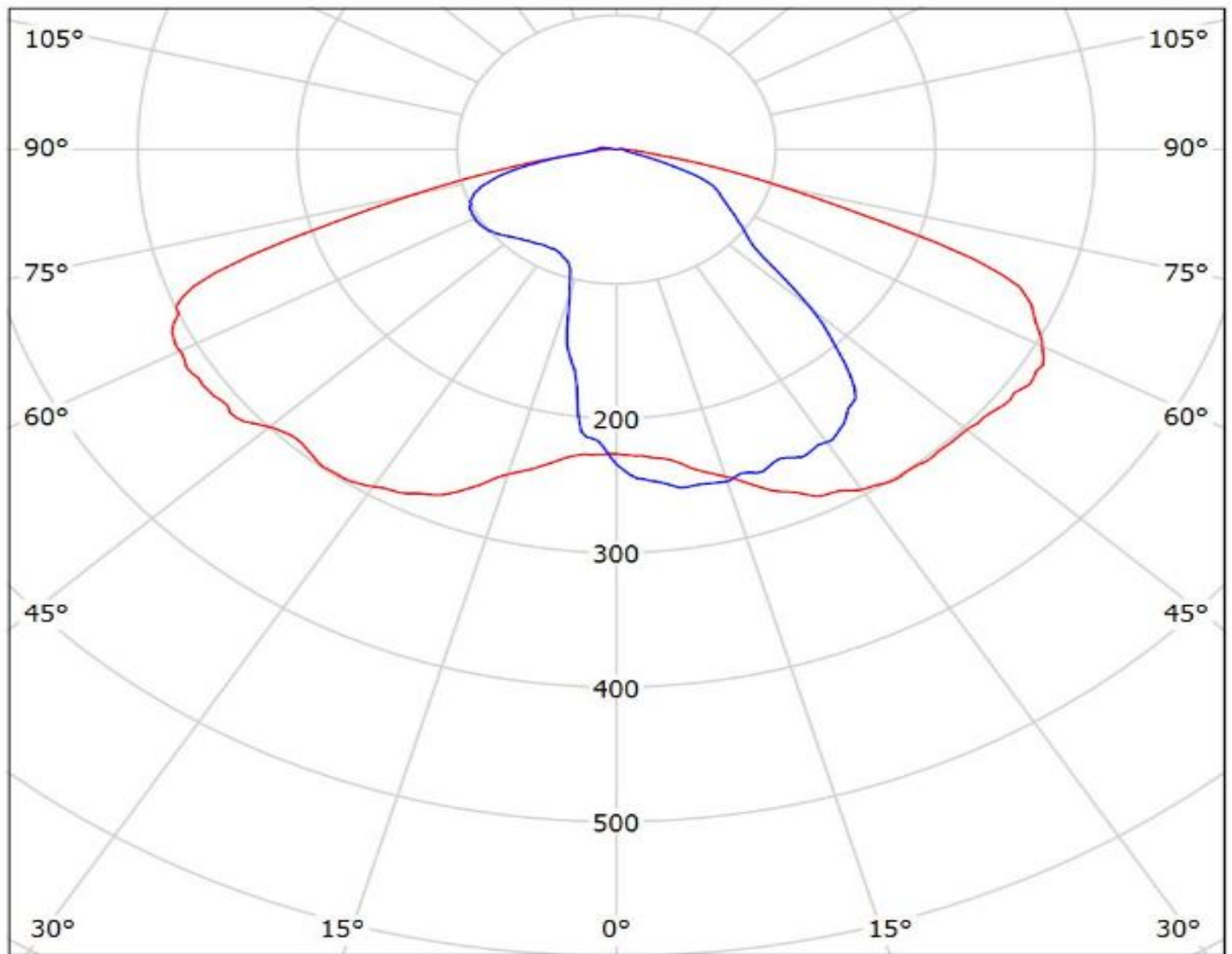

cd/klm
— C0 - C180 — C90 - C270

$\eta = 94\%$

Ledil FN13323_STELLA-A_(Soleriq_S13) / LDC (Polar)

Luminaire: Ledil FN13323_STELLA-A_(Soleriq_S13)

Lamps: 1 x Osram_Soleriq_S13_(GW_KAGHB1.EM)_875.214lm@250mA_P=7.44679W_I=250mA

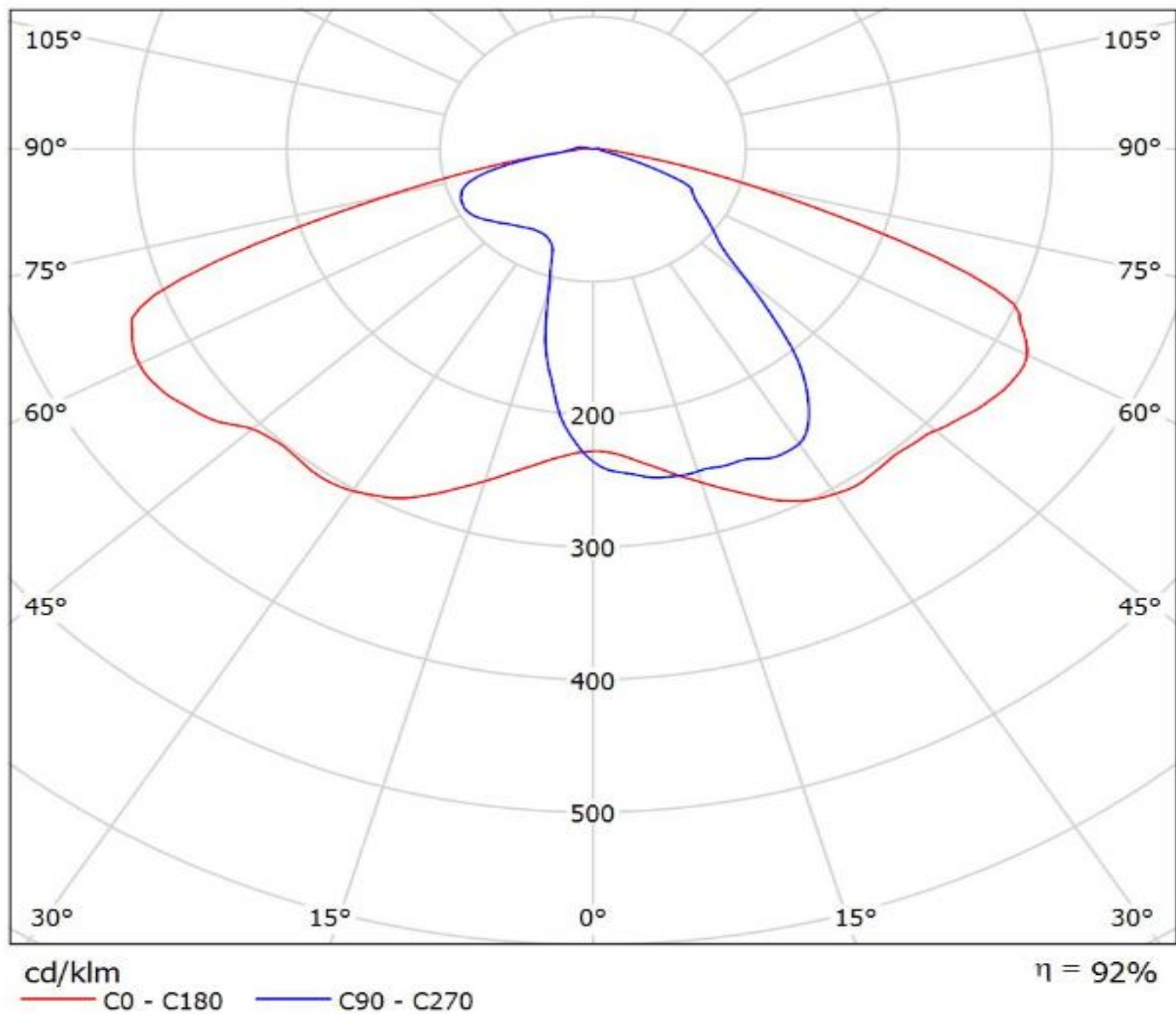

Luminaire: Ledil FN13323_STELLA-A_(Soleriq_P9)

Lamps: 1 x Osram_Soleriq_P9_(GW_MAFJB1.EM)_976.011lm@250mA_CCT=4299K_P=6.9W_I=0.25A

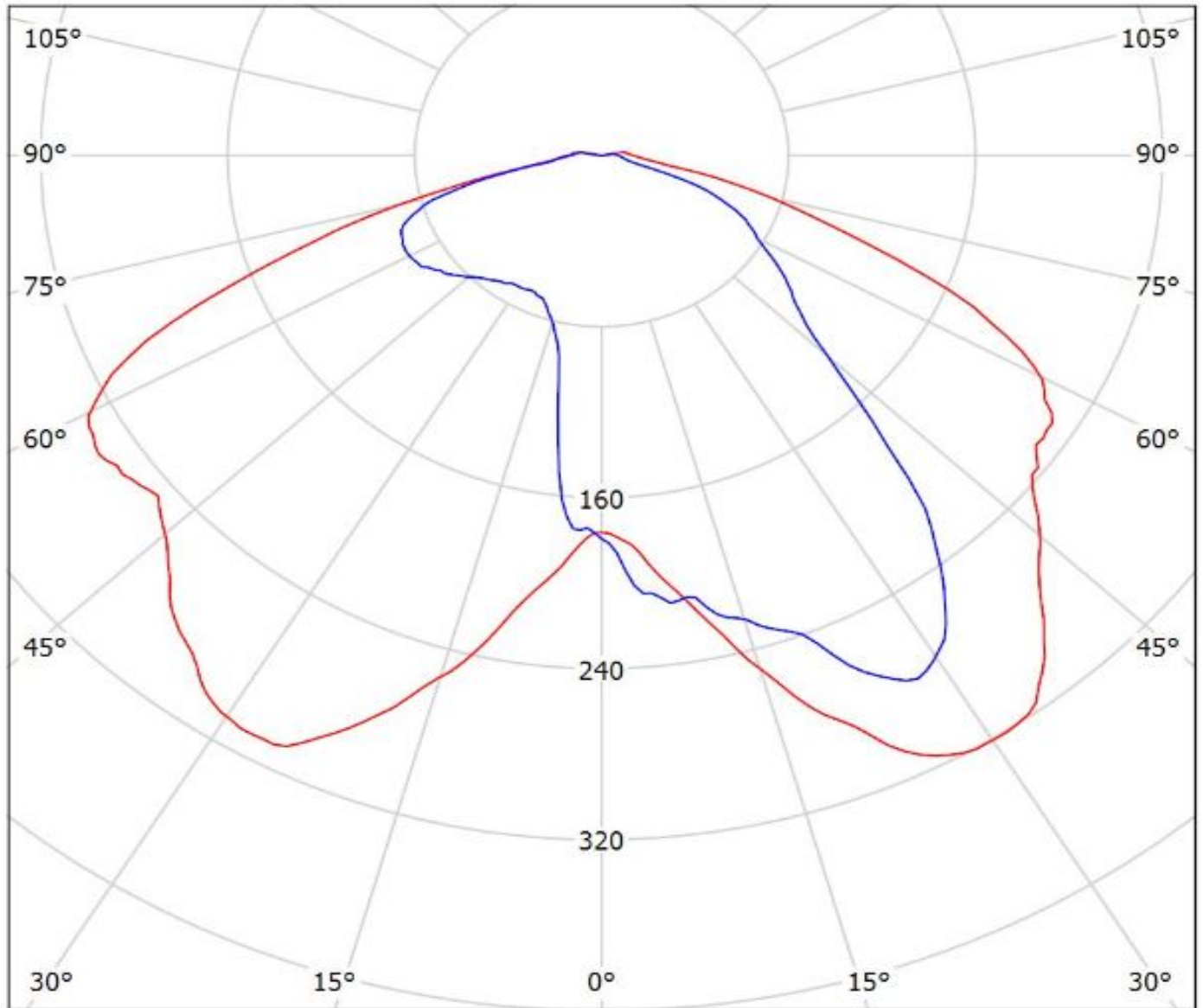

cd/klm
— C0 - C180 — C90 - C270

$\eta = 88\%$

Luminaire: LEDiL Oy FN13323_STELLA-A_(Megazenigata_GW6D) Eff.89.9%

Lamps: 1 x SHARP_Megazenigata_(GW6DMC40NFC)_1072.13lm@250mA_P=8.51443W_I=249.8mA

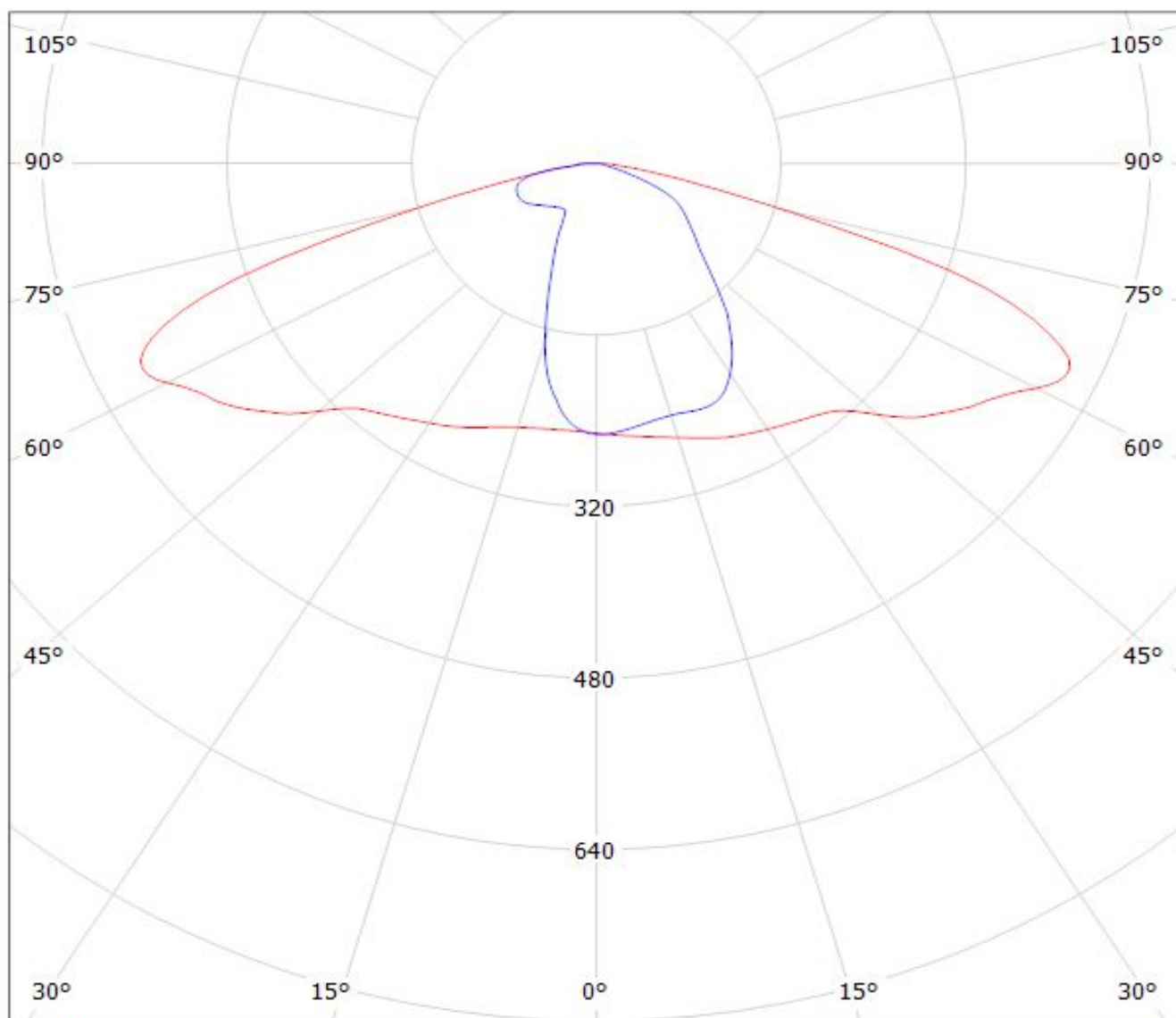

cd/klm

η = 90%

— C0 - C180

— C90 - C270

Luminaire: LEDiL Oy FN13323_STELLA-A_(SLE-G5_LES-15)

Lamps: 1 x Tridonic_SLE-G5_LES-15_1280.24lm@250mA_P=8.6273W_I=0.250A

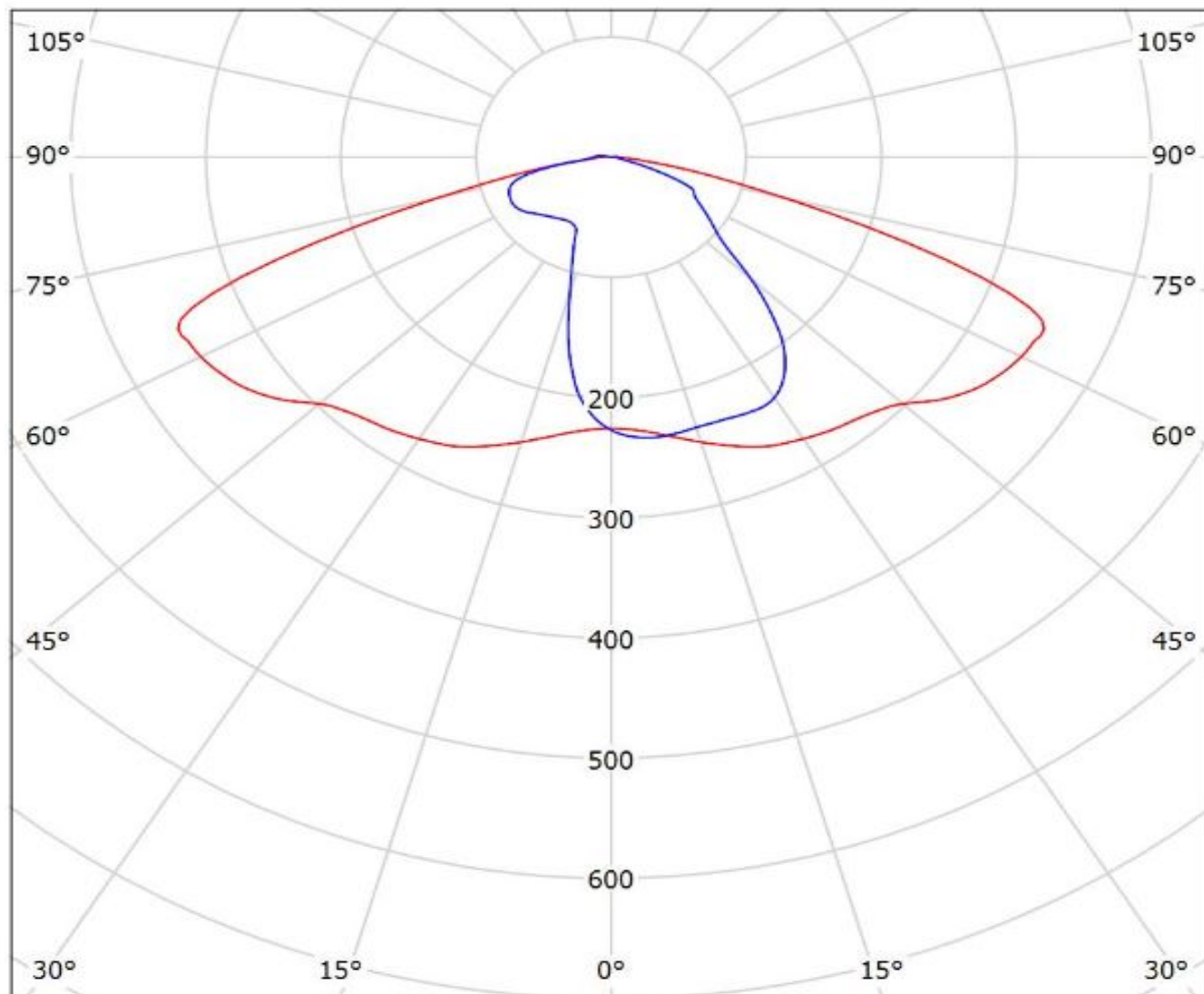

cd/klm

— C0 - C180 — C90 - C270

$\eta = 86\%$

NOTE: The typical divergence will be changed by different color, chip size and chip position tolerance. The typical total divergence is the full angle measured where the luminous intensity is half of the peak value.

GENERAL INFORMATION

- Product series especially designed & optimized for series of LEDs.
- Special care taken to make light distribution as uniform as possible.

Note! Due to use of high power COB's with this product, special attention to proper thermal design is highly recommended. LEDiL has no liability for direct, indirect or consecutive damages arising from the LEDiL products being used outside of the recommended temperature range.