



**MCP2515**  
**Development Kit**  
**User's Guide**

---

---

**Note the following details of the code protection feature on Microchip devices:**

- Microchip products meet the specification contained in their particular Microchip Data Sheet.
- Microchip believes that its family of products is one of the most secure families of its kind on the market today, when used in the intended manner and under normal conditions.
- There are dishonest and possibly illegal methods used to breach the code protection feature. All of these methods, to our knowledge, require using the Microchip products in a manner outside the operating specifications contained in Microchip's Data Sheets. Most likely, the person doing so is engaged in theft of intellectual property.
- Microchip is willing to work with the customer who is concerned about the integrity of their code.
- Neither Microchip nor any other semiconductor manufacturer can guarantee the security of their code. Code protection does not mean that we are guaranteeing the product as "unbreakable."

Code protection is constantly evolving. We at Microchip are committed to continuously improving the code protection features of our products. Attempts to break microchip's code protection feature may be a violation of the Digital Millennium Copyright Act. If such acts allow unauthorized access to your software or other copyrighted work, you may have a right to sue for relief under that Act.

---

Information contained in this publication regarding device applications and the like is intended through suggestion only and may be superseded by updates. It is your responsibility to ensure that your application meets with your specifications. No representation or warranty is given and no liability is assumed by Microchip Technology Incorporated with respect to the accuracy or use of such information, or infringement of patents or other intellectual property rights arising from such use or otherwise. Use of Microchip's products as critical components in life support systems is not authorized except with express written approval by Microchip. No licenses are conveyed, implicitly or otherwise, under any intellectual property rights.

#### Trademarks

The Microchip name and logo, the Microchip logo, dsPIC, KEELoQ, MPLAB, PIC, PICmicro, PICSTART, PRO MATE and PowerSmart are registered trademarks of Microchip Technology Incorporated in the U.S.A. and other countries.

FilterLab, microID, MXDEV, MXLAB, PICMASTER, SEEVAL and The Embedded Control Solutions Company are registered trademarks of Microchip Technology Incorporated in the U.S.A.

Accuron, Application Maestro, dsPICDEM, dsPICDEM.net, ECONOMONITOR, FanSense, FlexROM, fuzzyLAB, In-Circuit Serial Programming, ICSP, ICEPIC, microPort, Migratable Memory, MPASM, MPLIB, MPLINK, MPSIM, PICC, PICkit, PICDEM, PICDEM.net, PowerCal, PowerInfo, PowerMate, PowerTool, rLAB, rPIC, Select Mode, SmartSensor, SmartShunt, SmartTel and Total Endurance are trademarks of Microchip Technology Incorporated in the U.S.A. and other countries.

Serialized Quick Turn Programming (SQTP) is a service mark of Microchip Technology Incorporated in the U.S.A.

All other trademarks mentioned herein are property of their respective companies.

© 2003, Microchip Technology Incorporated, Printed in the U.S.A., All Rights Reserved.

 Printed on recycled paper.

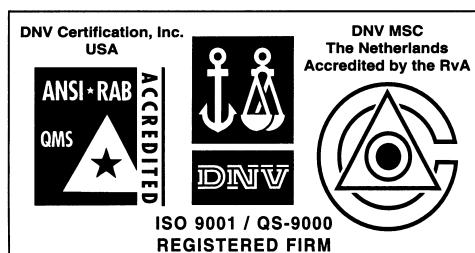

*Microchip received QS-9000 quality system certification for its worldwide headquarters, design and wafer fabrication facilities in Chandler and Tempe, Arizona in July 1999 and Mountain View, California in March 2002. The Company's quality system processes and procedures are QS-9000 compliant for its PICmicro® 8-bit MCUs, KEELoQ® code hopping devices, Serial EEPROMs, microperipherals, non-volatile memory and analog products. In addition, Microchip's quality system for the design and manufacture of development systems is ISO 9001 certified.*

---

---

**Table of Contents**

---

---

**Chapter 1. Introduction**

1.1	Introduction .....	1
1.2	Highlights .....	1
1.3	What the MCP2515 Development Kit Is .....	1
1.4	Multiple Uses for the MCP2515 Development Kit .....	2
1.5	How the MCP2515 Development Kit Helps You .....	3
1.6	Host Computer System Requirements .....	3

**Chapter 2. Installation**

2.1	Introduction .....	5
2.2	Highlights .....	5
2.3	MCP2515 Development Kit Components .....	6
2.4	Installing the Hardware .....	7
2.5	Installing the Software .....	7

**Chapter 3. Getting Started**

3.1	Introduction .....	9
3.2	Highlights .....	9
3.3	Software Overview .....	9
3.4	Starting the Program .....	12
3.5	Selecting the LPT Port .....	12
3.6	Hardware Overview .....	13

**Chapter 4. The Software Templates**

4.1	Introduction .....	15
4.2	Highlights .....	15
4.3	MCP2515 Register View Template .....	15
4.4	Basic Template .....	22
4.5	Menus .....	27

# MCP2510 Development Kit User's Guide

---

## Chapter 5. Reconfigure the Hardware

5.1	Introduction .....	29
5.2	Highlights .....	29
5.3	Node Configurations .....	29
5.4	Oscillator Configurations .....	30
5.5	The Jumper Settings .....	31

## Appendix A. Schematics

A.1	Introduction .....	33
A.2	Schematic .....	34

## Appendix B. FAQs on Configuring the MCP2515

B.1	Introduction .....	37
B.2	FAQs .....	37

---

---

## Chapter 1. Introduction

---

---

### 1.1 INTRODUCTION

This user's guide is written assuming some basic knowledge of the CAN protocol and the terms defined by the CAN protocol. Those users who do not have this basic CAN knowledge are encouraged to read Microchip's Application Note 713, "CAN Basics" (DS00713), the MCP2515 data sheet (DS21801) and/or the Bosch™ GmbH CAN specification, version 2.0. AN713 and the MCP2510 data sheet are available on Microchip's web site at [www.microchip.com](http://www.microchip.com).

### 1.2 HIGHLIGHTS

This chapter discusses:

- What the MCP2515 Development Kit is
- Multiple uses for the MCP2515 Development Kit
- How the MCP2515 Development Kit helps you
- Host computer system requirements

### 1.3 WHAT THE MCP2515 DEVELOPMENT KIT IS

The MCP2515 Development Kit is a two-node Controller Area Network (CAN) tool that can be used in the evaluation/implementation of the MCP2515 stand-alone CAN controller. The software allows manipulation of the MCP2515 at the bit and byte levels with one template, while providing high-level control with a second template.

- One node is controlled by the PC that acts as a microcontroller using the provided software. This node can be used for basic MCP2515 evaluation/development and will be referred to as "node 0" throughout this document.
- The second node is controlled by a microcontroller that is programmed by the user as part of device validation and/or system development.

The two nodes are connected via a CAN bus that is also routed off-board through a connector, allowing the target board to be connected to an external CAN bus. This node will be referred to as "node 1" throughout this document.

# MCP2515 Development Kit User's Guide

---

## 1.4 MULTIPLE USES FOR THE MCP2515 DEVELOPMENT KIT

The MCP2515 Development Kit is used for evaluation of CAN node development utilizing the MCP2515. The tool is ideal for beginner CAN designers and/or those new to the MCP2515. Basic input and output functionality can be easily demonstrated by transmitting and receiving CAN messages.

The MCP2515 Development Kit also has multiple board configurations (via cutting traces between jumper holes) that allow the user to customize as needed.

### 1.4.1 Use as an Evaluation Tool

Evaluation of the CAN protocol and the MCP2515 is easily accomplished by utilizing the software supplied with the kit. The software controls only one of the two nodes on the board. There are two templates that can be used, depending on what end result is desired. See **Chapter 3 "Getting Started"** for more details on the templates.

1. The Register template is used primarily for configuring/controlling individual registers in the MCP2515. All of the registers are modifiable, both bit-by-bit and byte-by-byte. This template allows the user to manipulate the MCP2515 registers and observe the affect on functionality. Different configurations can be set up and tested. Communication on the CAN bus is, typically, of secondary importance in this template.
2. The Basic template is designed to observe the MCP2515 while on a CAN bus. Direct register manipulation is not possible with this template, though bit rates and messages can be changed. Timed transmissions can also be achieved using this template. This template also serves as a simple bus monitor.

### 1.4.2 Use as a Development Tool

The MCP2515 Developer's Tool can assist in development of a MCP2515-based CAN node by utilizing node 1, either by itself, or in conjunction with node 0. Example, node 0 could be used as a simple bus monitor (using the Basic template) in order to monitor the development of node 1 (microcontroller node).

Node 0 may also be used to set/verify bit timings, masks and filters.

### 1.4.3 Multiple Configurations Possible

There are multiple board configurations that give the user versatility in node development/evaluation.

- The board has three oscillator sockets, allowing multiple oscillator configurations.
- The board has multiple CAN bus configurations (see **Chapter 5 “Reconfigure the Hardware”**).
- Prototyping areas are available to allow the use of other MCUs that are not supported by the provided sockets and to change the CAN’s physical layer.

Some of the configurations are achieved by trace cutting and installing jumpers. The board configurations and jumper locations are discussed in detail in Chapters 5 and 6.

## 1.5 HOW THE MCP2515 DEVELOPMENT KIT HELPS YOU

The MCP2515 Development Kit can help module and system designers get up to speed with the MCP2515 and aids in the development of the MCP2515 into a CAN bus.

By using this tool, the time to design completion can be greatly reduced. Furthermore, the multiple configurations makes development versatile and efficient.

## 1.6 HOST COMPUTER SYSTEM REQUIREMENTS

The software will run on Windows® 95/98, Windows NT<sup>SM</sup>/2000<sup>SM</sup>/XP<sup>SM</sup>. Windows XP requires drivers (`port95nt.exe`) that are downloadable from the Kvaser web site ([www.kvaser.se](http://www.kvaser.se)) or by searching the internet for “port95nt”. The port95nt software provides drivers for I/O access. The software can be installed with the minimal configuration by selecting custom install and checking only the driver install box.

# MCP2515 Development Kit User's Guide

---

NOTES:



## **Chapter 2. Installation**

---

---

### **2.1 INTRODUCTION**

This chapter describes the procedure for installing the MCP2515 Development Kit.

### **2.2 HIGHLIGHTS**

The items discussed in this chapter are:

- MCP2515 Development Kit components
- Installing the hardware
- Installing the software

# MCP2515 Development Kit User's Guide

---

## 2.3 MCP2515 DEVELOPMENT KIT COMPONENTS

The MCP2515 Development Kit consists of:

- MCP2515 Development Board (contains PICmicro® MCU with demo firmware)
- Male-to-male DB25 cable
- CD-ROM with program software, User's Guide and other supporting documents and code samples (forthcoming)
- Power cable and adapter
- Microchip Technical Library CD-ROM



**FIGURE 2-1: MCP2515 DEVELOPMENT KIT COMPONENTS**

## 2.4 INSTALLING THE HARDWARE

### 2.4.1 Required

The target board is connected to the PC via the provided 25-pin parallel cable (a standard male-to-male DB25 cable). LPT addresses supported are 0x3BC, 0x378 and 0x278.

Power to the target board is supplied by the included 9V power adapter.

### 2.4.2 Optional

There are two DB9 connectors:

One is a RS-232 interface for connecting to the PC as applications permit. This connector is connected to node 1 and is typically used during PICmicro MCU development to assist the user designing and/or debugging (e.g., it may be used to print register and/or receive buffer contents to the PC screen for debugging).

The other connector is a CAN bus interface that can be used to connect the board to an existing CAN bus. The pinout for this connector follows the defacto standard recommended pinout of pin 7 = CANH and pin 2 = CANL.

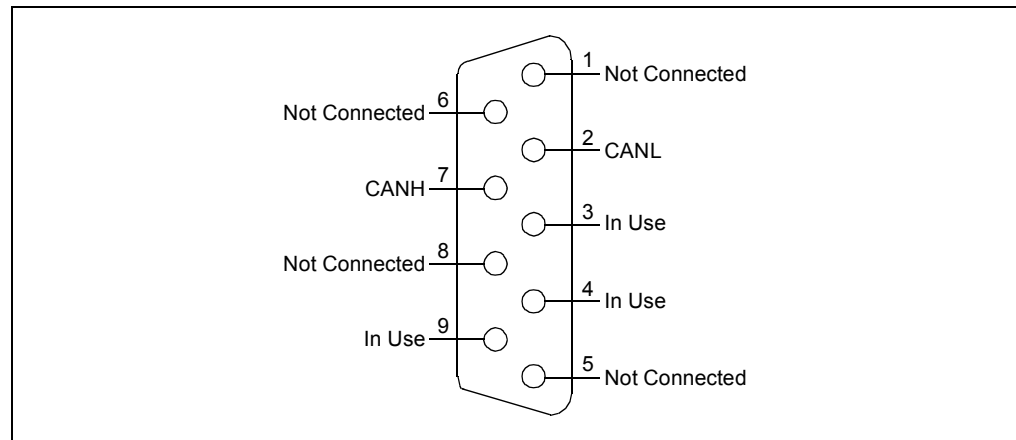

FIGURE 2-2: DB9 CAN BUS CONNECTOR

## 2.5 INSTALLING THE SOFTWARE

Insert the CD into the PC. Click the Start button and select **Run**. Enter the path to the file `wc32n.exe` or select **Browse** and find the file. Alternate method: Through Windows Explorer®, run the file named `wc32n.exe`. Follow the instructions for installing the software program.

**Note:** If installing on a Windows NT/2000/XP platform, third party drivers must be installed to allow I/O access to the parallel port. Refer to **Section 1.6 “Host Computer System Requirements”**.

# MCP2515 Development Kit User's Guide

---

NOTES:

---

---

## Chapter 3. Getting Started

---

---

### 3.1 INTRODUCTION

This chapter explains how to set up the MCP2515 Development Kit for basic evaluation operation.

### 3.2 HIGHLIGHTS

The items discussed in this chapter are:

- Software Overview
- Starting the Program
- Selecting the LPT Port
- Hardware Overview

### 3.3 SOFTWARE OVERVIEW

The software is an easy-to-use program with two templates that perform different functions. **Chapter 4 “The Software Templates”** details the operation of the templates and menu functions.

There are a couple of symbols that need explanation:

- A '\$' in front of the numbers represent hexadecimal.
- An 'x' after the number indicates a CAN protocol extended message. To type in an extended message, put the 'x' before the numbers to indicate that an extended message is being entered.

#### 3.3.1 MCP2515 Register View Template

This template allows low-level control of the MCP2515 and would typically be used to evaluate/test the MCP2515 at the bit level. All registers required for complete configuration are available in this template.

# MCP2515 Development Kit User's Guide

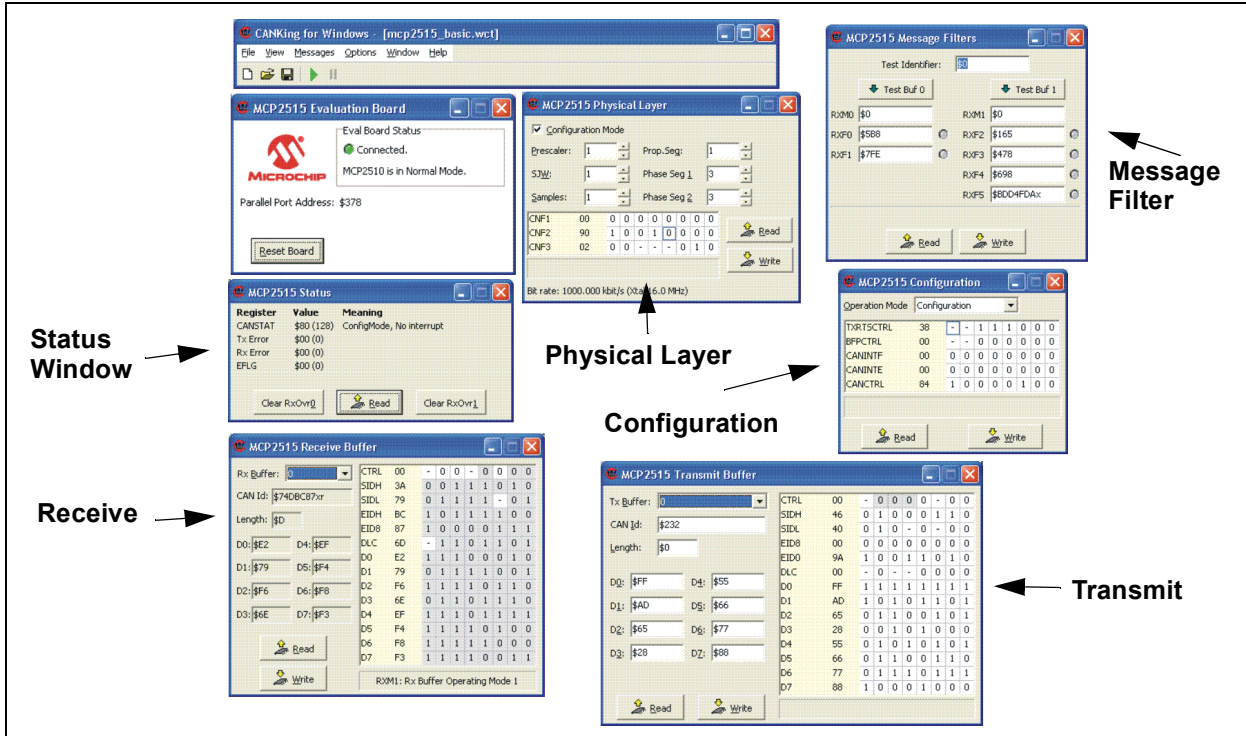

**FIGURE 3-3: MCP2515 REGISTER VIEW TEMPLATE**

The following windows are available in this template:

- Status** The status window shows the contents of the CANSTAT register (operation mode and interrupt flag codes), TX and RX error counts and EFLG register contents. Additionally, there are buttons to clear the overflow flag bits in the EFLG register.
- Message Filters** The masks and filters are configurable in this window, allowing the user to set up and test for message acceptance. The Message Filters window allows messages to be tested against the masks and filters without physically going on a bus.
- Physical Layer** The three CNF registers used for all CAN bit timings are configured in this window.
- Configuration** TXRTSCTRL, BFPCTRL, CANINTF, CANINTE and CANCTRL are all modified from this window. These are the control and flag registers.
- Transmit** The transmit window controls the buffer contents for the transmit registers, including TXBnCTRL, the identifier registers and the data registers.
- Receive** This window contains all of the buffer contents for the receive buffers, including RXBnCTRL, the identifier registers and the data registers.

## 3.3.2 Basic Template

The Basic template is a high-level tool that focuses on CAN bus traffic. This template would typically be used to observe the MCP2515 while on the bus. Node 1 development can be evaluated by using the basic template with node 0.

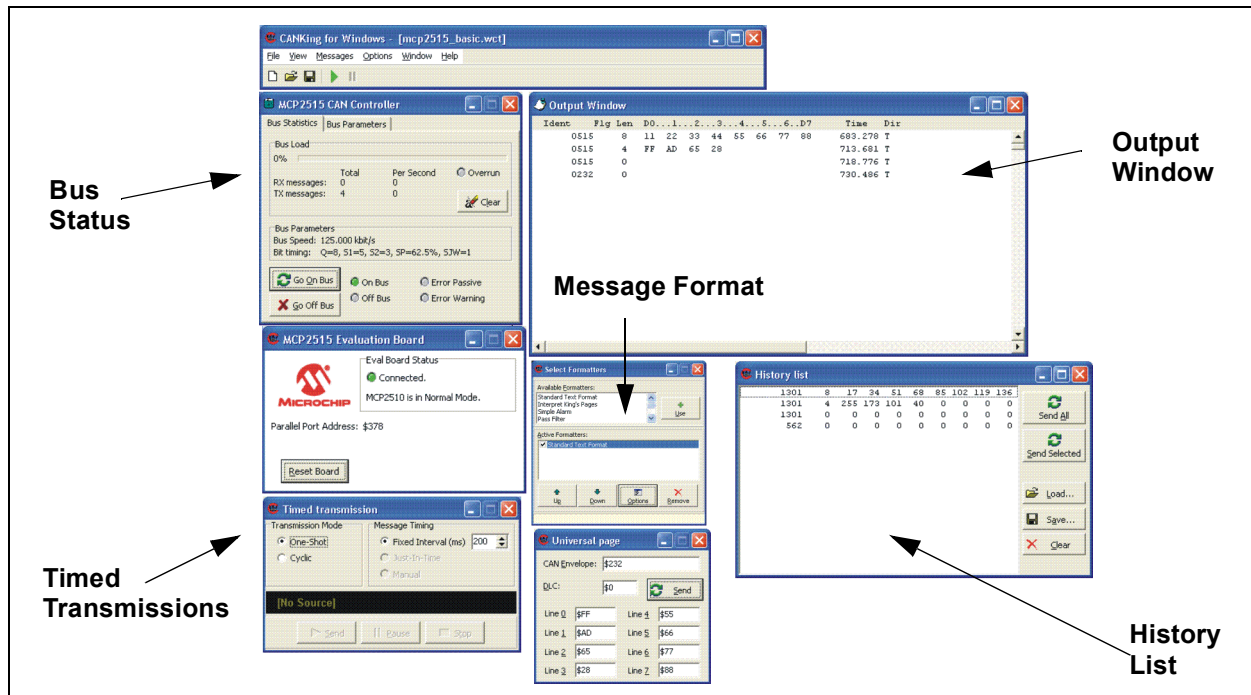

**FIGURE 3-4: BASIC TEMPLATE**

The following windows are associated with the Basic Template:

- Bus Status** This window, labeled MCP2515 CAN Controller, provides several pieces of information about the status of the bus, including nominal bus loading, status of the node (on or off the bus) and bus bit rate.
- Output** The Output window displays the messages that are received and transmitted. A time stamp indicates either delta times or running times between messages.
- History List** The History List window is used to collect transmitted messages for saving to a file. This file can be opened later and messages can be selected for retransmission. Some or all messages can be selected for transmission. This window works in conjunction with the Timed Transmissions window.
- Timed Transmissions** The Timed Transmissions window is used to send the messages in the History List window. The messages can be sent either one time (one shot) or repeatedly at regular intervals (cyclic).
- Message Format Window** The Message Format window determines the format of the displayed data in the output window. The default is Standard Text Format, which displays the message data as normal data.

# MCP2515 Development Kit User's Guide

---

## 3.4 STARTING THE PROGRAM

1. To run the software, either select *Start > Programs > Microchip > CANKing* or find *WC32.exe* using Windows Explorer.
2. A dialog box will appear stating that putting this system on a CAN bus without proper configuration may adversely affect the bus. Click **Okay**.
3. A window will appear prompting to open a template or a project. If this is the first time running the program, select **Template** (no projects exist yet).
4. Select a template to open (Basic or MCP2515 Register View).

## 3.5 SELECTING THE LPT PORT

When starting the program for the first time after installation, it may be necessary to select the proper LPT port address from the available list (*Options > MCP2515...*).



## 3.6 HARDWARE OVERVIEW

The target board consists of two CAN nodes (MCU, MCP2515), a transceiver, an embedded CAN bus and support components.

The two nodes are connected to the embedded bus. By default, the embedded CAN bus is connected to the CAN connector (DB9), which is a link to an external CAN bus.

The support components are defined as all of the components that interface with the nodes as controls, indicators and other peripherals.

Figure 3-5 shows the main components of the board.

<b>LPT Port</b>	The link between the MCP2515 and the PC that acts as the MCU for node0. The parallel port is used to allow the PC to communicate with MCP2515 via SPI.
<b>COM Port</b>	The communications port (COM) is connected to the PICmicro MCU sockets (USART pins) via a MAX-232 device so that serial communication is possible between the PICmicro MCU and PC.
<b>Oscillators</b>	The three oscillator socket's outputs are connected together by default, so only one oscillator is needed to clock both MCP2515s and the PICmicro MCU. By cutting traces and installing jumpers, other oscillator configurations can be achieved. See <b>Chapter 5 "Reconfigure the Hardware"</b> for more detail on configuring the oscillator sockets.
<b>PICmicro MCU Sockets</b>	Three sockets are provided to give the user a wide range of PICmicro MCUs to choose from when developing firmware.
<b>MCU Prototype Area</b>	This area was created for prototyping MCUs that are not supported with the sockets or for prototyping complete CAN nodes.
<b>Nonvolatile Memory</b>	Use of the 64-kbit SPI EEPROM is defined by the user. Since it is on the same SPI bus as the MCP2515, care has to be taken to utilize the chip selects properly.
<b>MCP2515</b>	The MCP2515 is the interface between the CAN bus and the MCU.
<b>CAN Transceiver</b>	The CAN transceiver converts the differential signal on the bus to digital levels for the CAN controller and vice versa.
<b>LED Banks</b>	The LED banks reflect the state of many of the pins on the MCP2515.
<b>RTS Buttons</b>	These buttons are used to request transmission of the corresponding MCP2515's transmit buffer if the pin is configured as RTS inputs or used as digital inputs.
<b>CAN Connector</b>	The CAN connector is used to connect the MCP2515 Development Kit to an external bus.

# MCP2515 Development Kit User's Guide

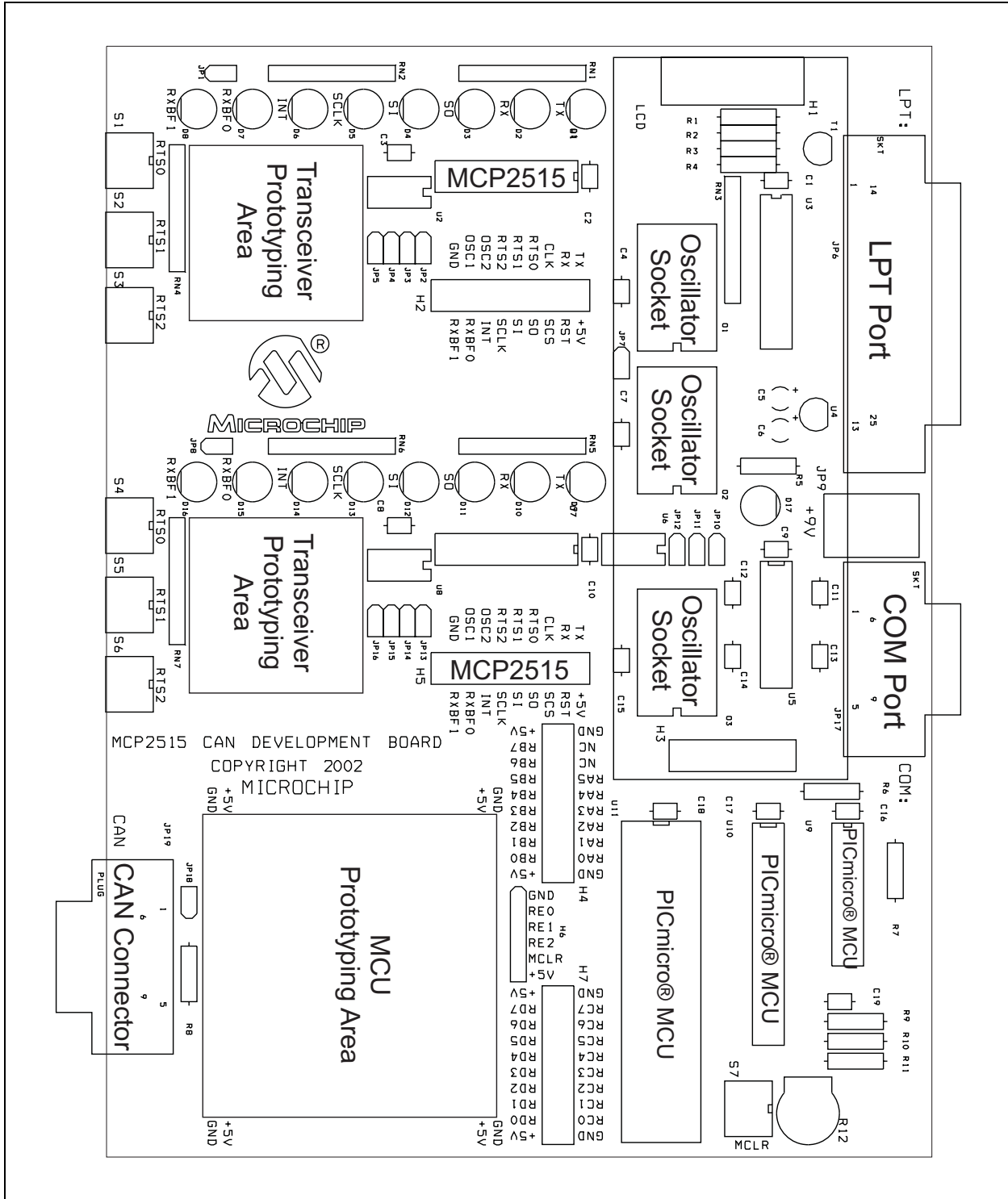

**FIGURE 3-5: MCP2515 CAN DEVELOPMENT BOARD**

---

---

## Chapter 4. The Software Templates

---

---

### 4.1 INTRODUCTION

There are two templates included with the MCP2515 Development Kit that give the user low-level bit control, or high-level message control, of the MCP2515.

### 4.2 HIGHLIGHTS

The items discussed in this chapter are:

- MCP2515 Register View template
- Basic template
- Menus

### 4.3 MCP2515 REGISTER VIEW TEMPLATE

This template allows low-level control of the MCP2515 and is typically used to evaluate/test the MCP2515 at the bit level. All registers required for complete configuration are available in this template.

Register values can be changed on both a byte level and a bit level. To modify the register on a byte level, simply enter the value in the boxes next to the register names. Notice that the bit values will reflect the entered byte values.

To modify the registers at the bit level, double-click the desired bit. The bit will toggle for each double-click and the byte representation will be reflected next to the register name.

The bit boxes are only modifiable when unshaded. Shaded bit boxes are read-only bits.

# MCP2515 Development Kit User's Guide

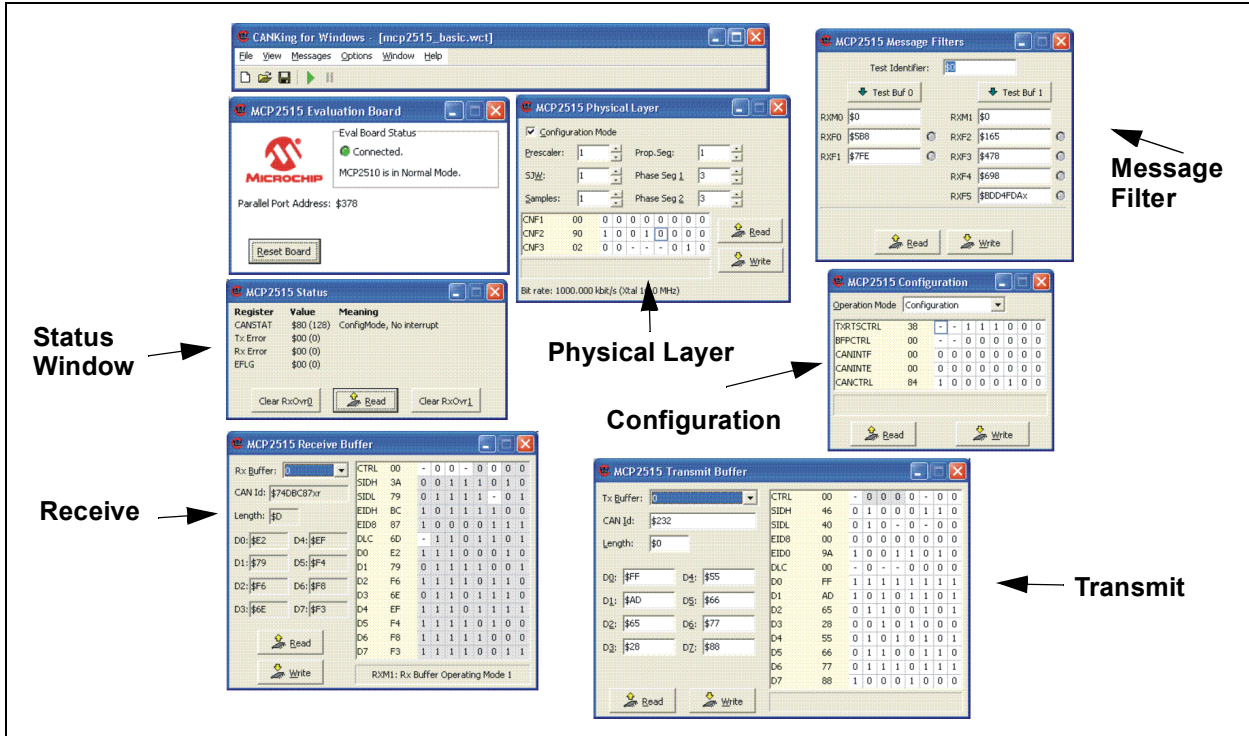

**FIGURE 4-6: MCP2515 REGISTER VIEW TEMPLATE**

This section discusses each of the template windows in detail.

### 4.3.1 Status Window

The Status window displays the contents of the CANSTAT register, the EFLG register and the counts for the receive and transmit error counters. In addition, it contains buttons to clear each of the receive buffers' overrun conditions.

The condition of the registers are also shown (e.g., CANSTAT = 80h displays the condition as Configuration mode with no interrupts pending).

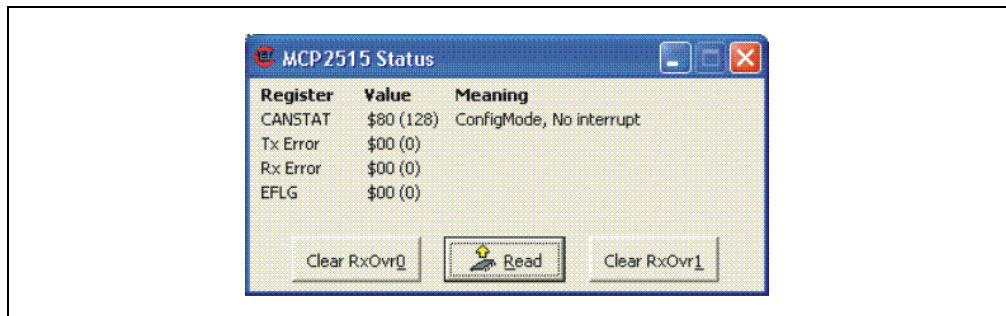

**FIGURE 4-7: STATUS WINDOW**

## 4.3.2 Message Filters Window

This window is used to set up and test mask and filter combinations with different message identifiers. Each mask and filter can be tested without actually writing the configuration to the MCP2515. This is done to allow the user to test different configurations against message identifiers that would appear on the bus.

For example, Figure 4-8 shows an identifier of 155h matching up against filter RXF1 and shows that the message would be accepted into receive buffer 0.

When the desired mask and filter combinations are achieved, the values can be written to the MCP2515 by clicking the **Write** button.

**Note:** The masks and filters can be written only when the MCP2515 is in Configuration mode.

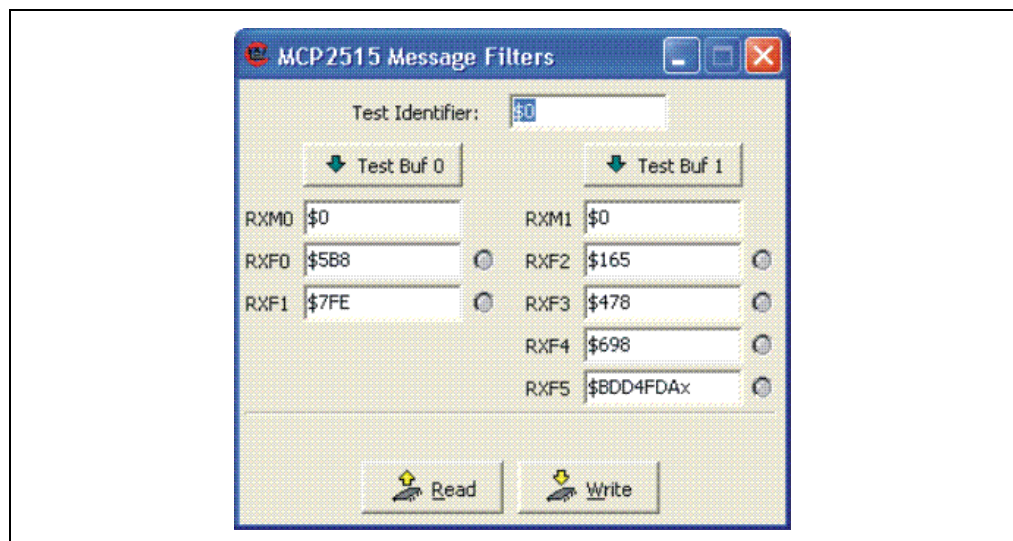

FIGURE 4-8: MESSAGE FILTER WINDOW

# MCP2515 Development Kit User's Guide

## 4.3.3 Physical Layer Window

The Physical Layer window is where the CAN bus rate is configured. The user has bit-level control of the three CNF registers (CNF1, CNF2 and CNF3) that set up all items required for CAN bit timing, including the time quanta (TQ), bit segments, the synchronization jump width (SJW) and the baud rate prescaler (BRP).

The calculated bit rate is shown at the bottom of the window. For this calculation to be correct, the oscillator value must be correct. To change oscillator values, select Options > MCP2515... from the menu bar.

**Note:** The CNF registers can be modified only when the MCP2515 is in Configuration mode and will display shaded in all other modes of operation.

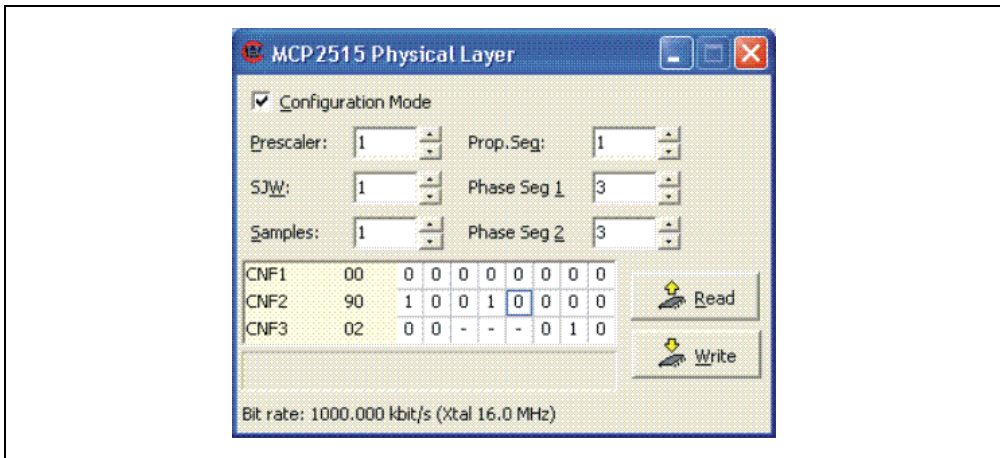

FIGURE 4-9: PHYSICAL LAYER WINDOW

## 4.3.4 Configuration Window

TXRTSCTRL, BFPCTRL, CANINTF, CANINTE and CANCTRL are all modified from this window. These are the control and flag registers for the MCP2515.

### 4.3.4.1 TXRTSCTRL

This register configures the RTS pins ( $\overline{\text{TXnRTS}}$ ) as either request-to-send or as digital inputs. The pin values are displayed in the register if configured as digital inputs.

### 4.3.4.2 BFPCTRL

This register configures the receive buffer full pins ( $\overline{\text{RXnBF}}$ ) as buffer full interrupts or digital outputs. The value of the pins are displayed if configured as digital outputs.

### 4.3.4.3 CANINTF

CANINTF is the flag register for the eight sources of interrupts.

### 4.3.4.4 CANINTE

This register is the interrupt-enable for the eight interrupt sources. Enabled interrupts are mapped to the  $\overline{\text{INT}}$  pin.

### 4.3.4.5 CANCTRL

CANCTRL sets the modes of operation and the clock out enable and prescaler (CLKOUT pin).

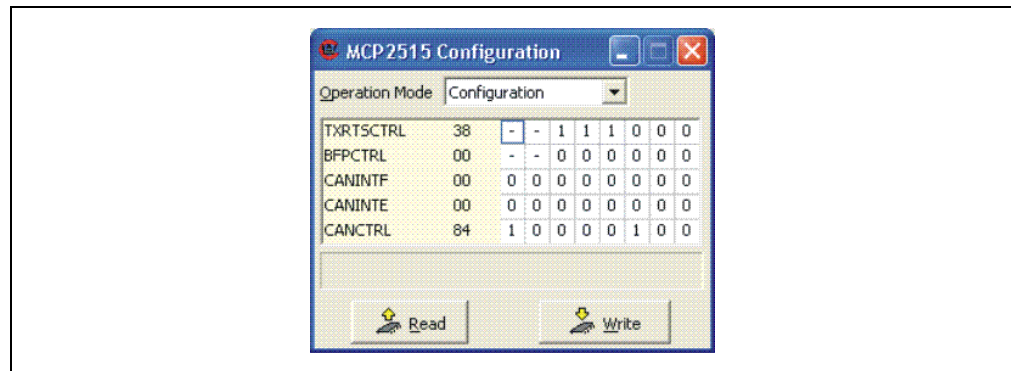

FIGURE 4-10: CONFIGURATION WINDOW

# MCP2515 Development Kit User's Guide

## 4.3.5 Transmit Window

The Transmit window controls the buffer contents for the three transmit registers, including TXBnCTRL, the identifier registers and the data registers. The transmit buffers are selected using the Tx Buffer pull-down box.

Like the other register windows, the Transmit window maps the byte values to the bit boxes. Entering data into the CAN ID box maps to multiple registers (SIDH, SIDL, EID8 and EID0). **Example:** Entering 1FFFFFFFh in the CAN ID box maps all '1s' to SIDH, SIDL, EID8 and EID0.

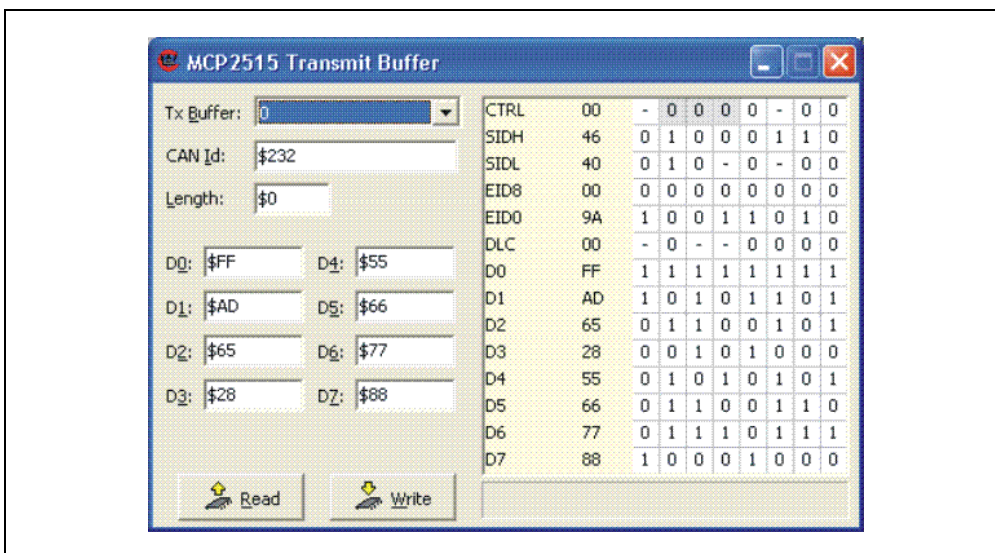

FIGURE 4-11: TRANSMIT WINDOW



## 4.3.6 Receive Window

This window contains all buffer contents for the receive buffers, including RXBnCTRL, the identifier registers and the data registers.

RXB0CTRL and RXB1CTRL are the only registers in this window that are not read-only, as indicated by the unshaded bit locations. These two registers set up the receive modes and enables/disables the rollover function.

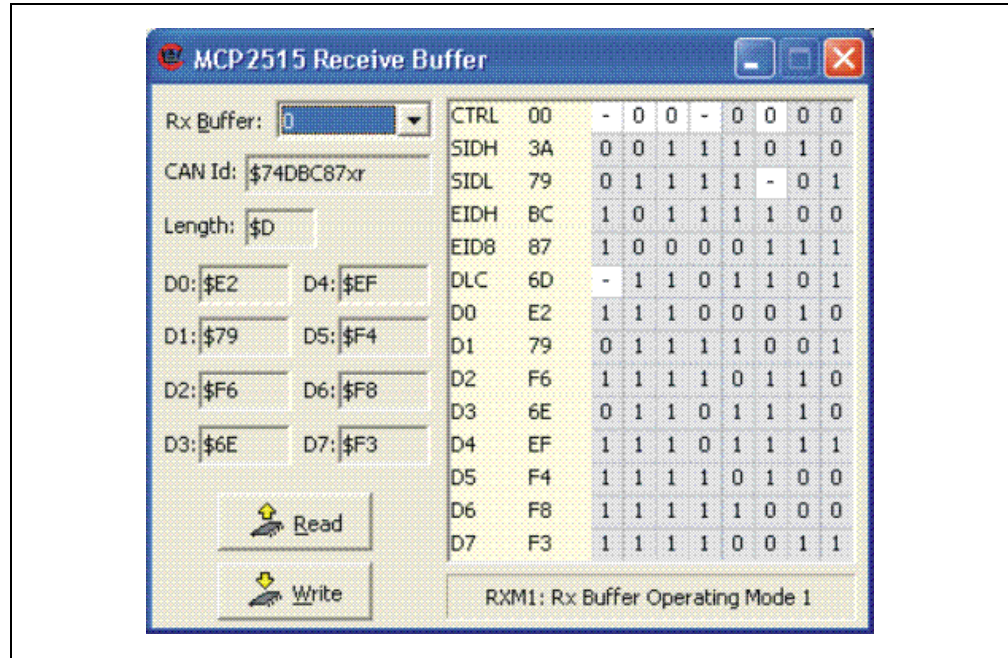

**FIGURE 4-12: RECEIVE WINDOW**

**Note:** Selecting *Messages > MCP2515 Eval Board > Receive Buffer* (or Transmit Buffer) while holding down the shift key will open up duplicate windows so multiple transmit or receive windows can be monitored simultaneously.

# MCP2515 Development Kit User's Guide

## 4.4 BASIC TEMPLATE

The Basic template is a high-level tool that focuses on CAN bus traffic. The user only has high-level control of the MCP2515 (i.e., no direct register control) that includes:

- Configuring the bus rate
- Changing modes of operation (Configuration and Normal)
- Configuring a transmit register (the register number is predefined)
- Transmitting messages
- Resetting the MCP2515

Other functions of the Basic template include receiving messages, saving transmitted messages, starting timed transmissions and observing the bus loading. Details of these functions can be found later in this section under the details of the individual windows.

**Note:** Node 0 is configured to receive ALL messages by default while in the Basic template. The user has the option to maintain MCP2515 configurations when switching templates by selecting *Options > MCP2515...* and deselecting the Reset MCP2515 on Opening box. Keep in mind that deselecting this box may create unforeseen problems if the MCP2515 was not previously configured properly.

This template would typically be used as a simple bus monitor for evaluating the MCP2515 on a CAN bus or in assisting development by monitoring how node 1 is operating.

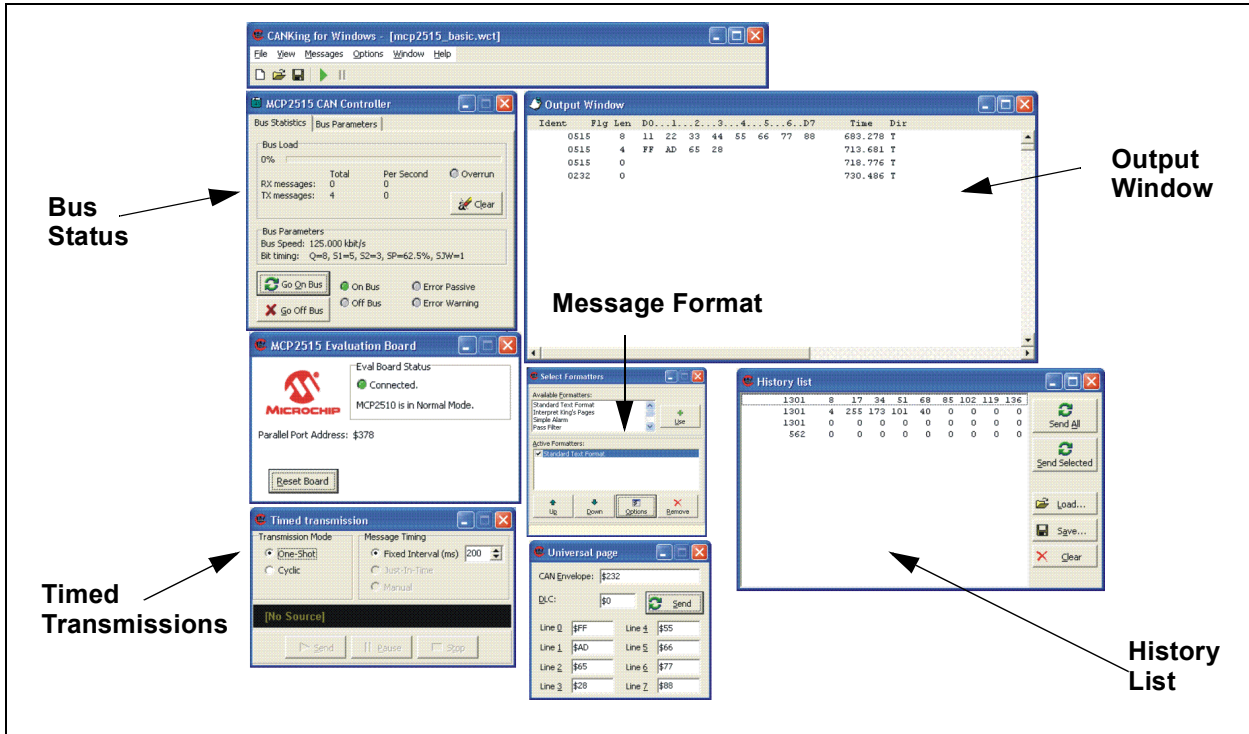

FIGURE 4-13: THE BASIC TEMPLATE

## 4.4.1 Bus Status Window

This window, labeled “MCP2515 CAN Controller”, provides several pieces of information about the status of the bus, including nominal bus loading, status of node (on or off the bus) and bus bit rate. The tabs at the top of the window toggle between the Bus Statistics and Bus Parameters view.

In the Bus Statistics view, the bus loading, bus parameters and bus status may be viewed. The bus loading shows the nominal load on the CAN bus as a percentage and as a number, as well as the total number of messages sent and received. The bus parameters simply reflect the parameters that were set in the Bus Parameters view (i.e., bit rate, number of TQ, bit segment lengths and the location of the sample point). The bus status shows the mode of operation, error states and gives the user the ability to switch modes of operation between Normal and Configuration.

The Bus Parameters view allows configuration of the bus rate, the sample point, the synchronizing jump width (SJW) and switching between Normal and Listen-Only modes of operation.

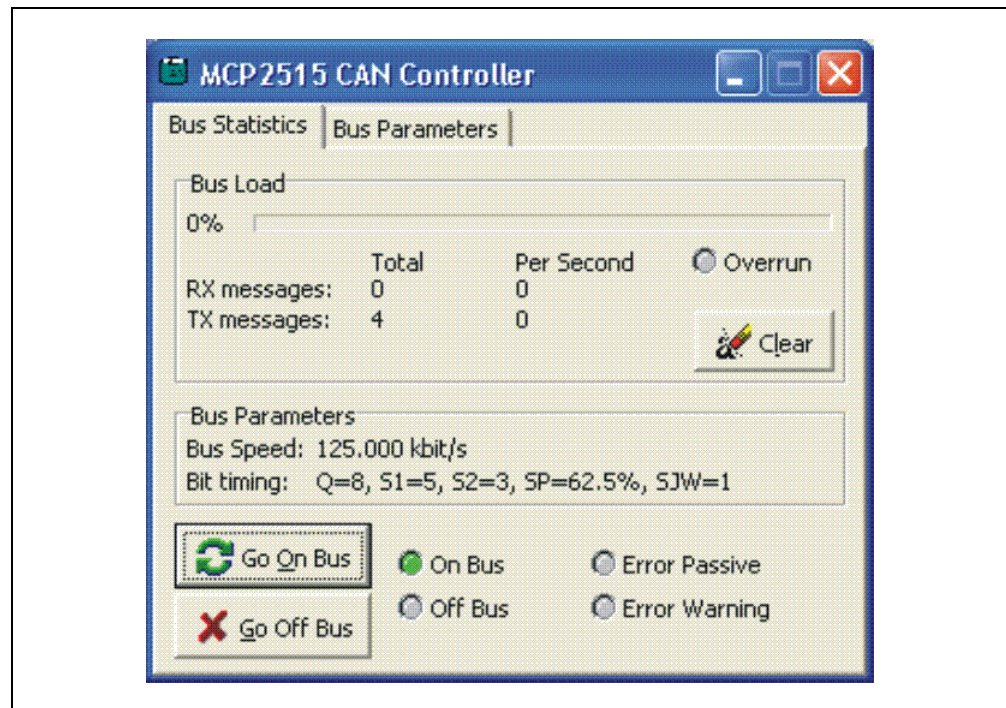

FIGURE 4-14: BUS STATUS

# MCP2515 Development Kit User's Guide

## 4.4.2 Output Window

The output window displays the messages that are received and transmitted by node 0. This window can be reconfigured to display messages in different formats. The formats are changed using a combination of the Message Format window and the right mouse button.

Changing the format type and/or the properties in the Message Format window alters the display in the output window. The numeric base (base 8, base 10 or base 16) can be changed. The time stamping function can also be changed to either a running time or a delta time. See Section 4.4.5 “**Message Formats Window**” for more details.

Clicking the right mouse button while in this window brings up a menu that includes auto-scroll, fixed positions and cut/paste functions.

Auto-Scroll appends new messages to the bottom of the displayed messages so all messages are captured in the window. This feature allows the user to observe the order and frequency of messages on the bus.

Selecting Fixed Positions effectively assigns a slot for each message identifier. As messages with the same ID are received or transmitted, they overwrite the data contents of the previous message with the same ID. Used in conjunction with the delta time feature, the frequency of each message type can be observed.

The cut and paste menu items are standard operating system features.

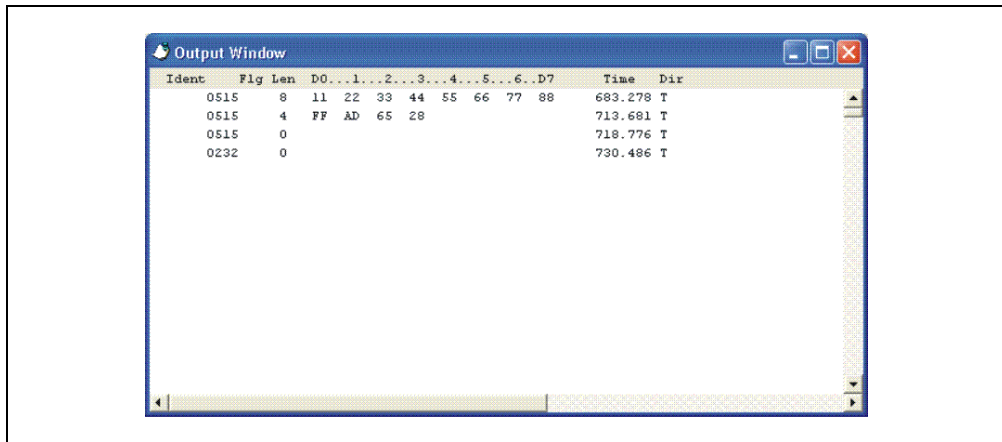

FIGURE 4-15: OUTPUT WINDOW

## 4.4.3 History List Window

The History List window is used to collect transmitted messages for saving to a file. This window is not opened by default when opening a new template and is opened by selecting *View > History List*. Once opened, every transmitted message is captured in the History List window for saving to a file, if desired.

One or more messages can be selected for retransmission. There is also a button for sending all the captured messages.

**Note:** The History List window works in conjunction with the Timed Transmission window. Messages can be retransmitted once or continually at defined intervals. See the Timed Transmission description for more details.

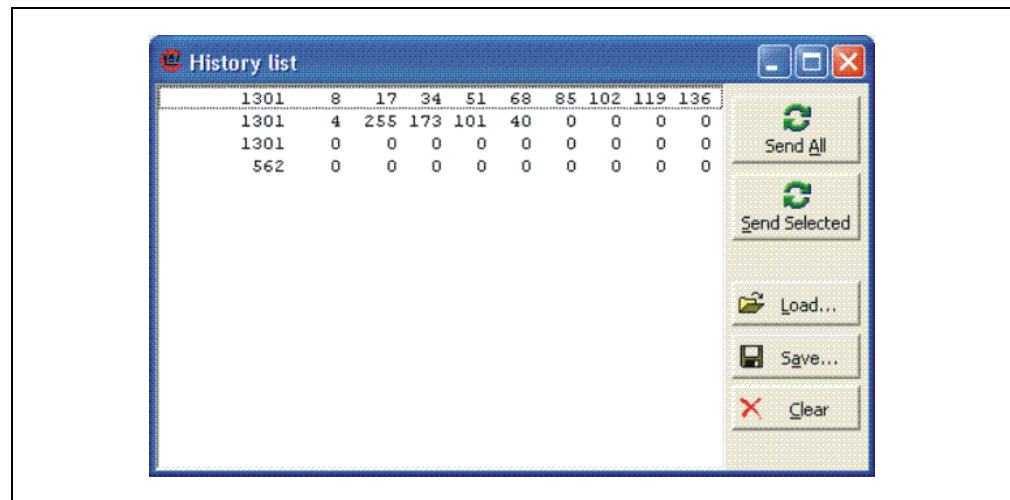

FIGURE 4-16: HISTORY LIST WINDOW

# MCP2515 Development Kit User's Guide

## 4.4.4 Timed Transmissions Window

The Timed Transmissions window is used to send the messages in the History List window, either one time or continually at timed intervals.

The One Shot mode sends the selected (in the History List window) messages once each time the send buttons are pressed in the History List window.

The Cyclic selection sends the selected messages at regular selectable intervals (100 ms – 10 s). The other selections, Just-in-Time and Manual are not available in this software.

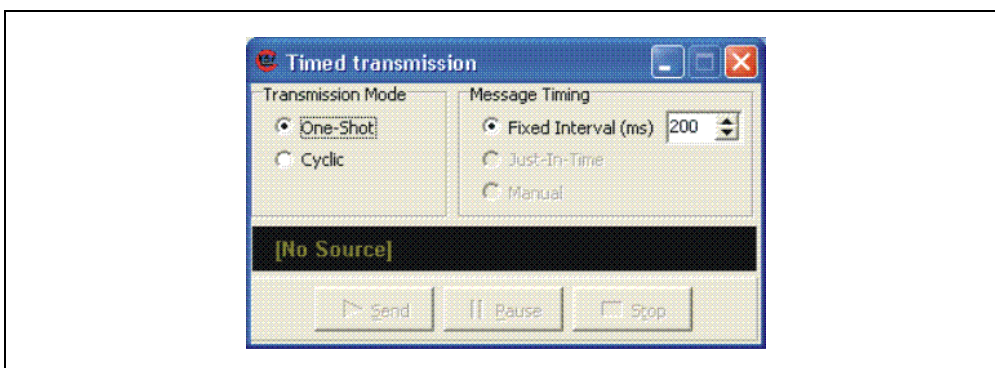

FIGURE 4-17: TIMED TRANSMISSION WINDOW

## 4.4.5 Message Formats Window

This window determines the format of the displayed data in the output window. The default is Standard Text Format, which displays the message data as normal data. The properties of the Standard Text format can be changed by pressing the **Properties** button while highlighted. The properties are the numeric base and whether or not to display the message time stamp as a running total or as a delta.

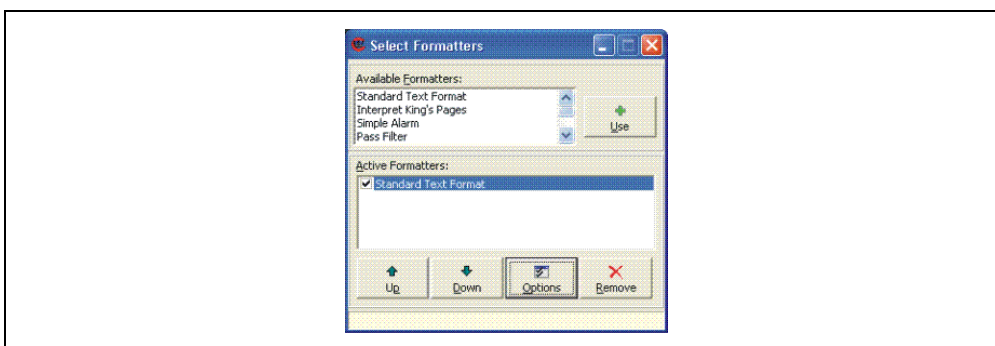

FIGURE 4-18: MESSAGE FORMATS WINDOW

## 4.5 MENUS

The menu items, for the most part, are identical in both the Register and Basic template views. The few exceptions will be indicated in the descriptions below. Only two menu items will be discussed in this section, as the others are self-explanatory.

### 4.5.1 Messages menu

In the Basic template, this menu contains the message types to be transmitted. Selecting message types opens a window that the user can configure to transmit a message. Example, selecting *Messages > Universal > Universal* opens a window for transmitting a normal (up to eight bytes) message.

The CAN Kingdom message-type menu items are for transmitting messages that adhere to the CAN Kingdom higher-layer protocol (HLP).

### 4.5.2 Options menu

The options menu contains the configurable properties of both the hardware and the software.

The default numeric base is selected by *Options > Global*. Auto-save switches are also contained here.

*Options > MCP2515...* is where the LPT port address is selected. It is also where the oscillator frequency is set in software. Additionally, this menu contains a switch that determines whether or not the MCP2515 will be reset on file open. This feature is for those users who want to switch between templates without changing the MCP2515 configuration (e.g., masks and filters are set to receive ALL messages in the Basic template, unless this box is deselected).

**Note:** The oscillator frequency must be set in software to match the hardware so the software can configure the bit timing registers correctly. The formulas for bit timing contain an oscillator frequency.



FIGURE 4-19: MENU BAR

# MCP2515 Development Kit User's Guide

---

NOTES:



---

---

## Chapter 5. Reconfigure the Hardware

---

---

### 5.1 INTRODUCTION

The MCP2515 Development Kit has several different configurations that make it a versatile tool.

### 5.2 HIGHLIGHTS

The items discussed in this chapter are:

- Node Configurations
- Oscillator Routing
- The Jumper Settings

### 5.3 NODE CONFIGURATIONS

The versatility of the MCP2515 Development Kit is possible by changing the configuration of the board. Refer to **Section 5.5 “The Jumper Settings”** for a list of the various jumper settings required to change board configurations. There are five common configurations.

<p><b>Note:</b> All jumper locations are shorted by default, unless otherwise specified. The traces must be cut if the installed jumpers are to function properly.</p>
--

#### 5.3.1 PC Node Non-Distributed (one node, no CAN bus)

This is a default configuration in which the PC acts as a microcontroller for node 0. This configuration does not have to be connected to the CAN bus because no CAN communication occurs. This configuration is used for evaluation of, or familiarization with, the MCP2515. The Register template would be used. The masks, filters and register functions can easily be evaluated in this configuration.

# MCP2515 Development Kit User's Guide

---

## 5.3.2 PC Node Distributed (one node, on CAN bus)

This configuration is the same as above, with the exception that it is connected to an external CAN bus via the CAN connector (DB9).

Typically, this configuration would be used to further evaluate the MCP2515 by observing how it functions on an external CAN bus. Experimentation with bit timings, masks and filters, interrupts, RTS pins, etc. can be performed while using the Register template. While in the configuration, simple bus monitoring can be achieved using the Basic template.

## 5.3.3 Two Node Embedded System

This configuration utilizes node 0 and node 1 to create a two node, embedded system (no external bus).

This configuration can be used for evaluation or development. The microcontroller firmware is being developed at this point. As an example, the firmware may be written to observe how the MCP2515 uses masks and filters to accept/reject messages. SPI modules and interrupt handlers may be under development at this stage.

## 5.3.4 Two Node Distributed System

This configuration places both nodes on the CAN bus.

One scenario utilizes the microcontroller node as the node under development, while the PC node is simply a bus monitor to assist in debugging.

## 5.3.5 Microcontroller Distributed System (One Node)

This configuration places the microcontroller node (node 1) on the CAN bus.

## 5.4 OSCILLATOR CONFIGURATIONS

There are three oscillator sockets. By default, both MCP2515s and the PICmicro<sup>®</sup> MCU sockets use a common oscillator. Since all three socket outputs are tied together, the oscillator can be placed in any socket.

**Warning:** Care must be taken when installing more than one oscillator. The jumper settings must be correct or contention will occur at some or all of the device oscillator inputs. This could have catastrophic results.

It is possible for each node and the microcontrollers to have their own oscillator by configuring the jumpers as described later in this chapter.

## 5.5 THE JUMPER SETTINGS

There are multiple jumper settings that allow the MCP2515 Development Kit to be configured in different ways.

There are jumpers that allow the transceivers to be disconnected so another physical layer can be added either in the prototyping area or by adding a daughter board that is manufactured by a third party. Contact Kvaser™ AB for more information ([www.kvaser.se](http://www.kvaser.se)).

There are also jumpers that disconnect the three oscillators from each other. A CAN bus-terminating resistor (120 ohm) can be jumpered in. Finally, the LED banks can be disconnected, if so desired.

**Note:** All jumpers are shorted with a copper trace (bottom-side of board) by default and require cutting to open. Jumper pins can be soldered in the holes to allow jumper connectors to be used.

**TABLE 5-1: JUMPER DESCRIPTION**

Jumper	Description
JP1	Connects LEDs for Node 0
JP2	Connects Node0 MCP2551 RS pin to external bus (DB9 J4)†
JP3	Connects Node0 MCP2551 CANH pin to external bus (DB9 J4)†
JP4	Connects Node0 MCP2551 CANL pin to external bus (DB9 J4)†
JP5	Connects Node0 MCP2551 RXD pin to external bus (DB9 J4)†
JP6	Connects oscillator O2 to oscillator O1
JP7	Connects LEDs for Node 1
JP8	Connects oscillator O3 to oscillator O1
JP9	Connects oscillator O3 to oscillator O2
JP10	Connects Node 1 MCP2515 INT pin to PICmicro® MCU RB0 pin
JP11	Connects Node 1 MCP2551 RS pin to external bus (DB9 J4)†
JP12	Connects Node 1 MCP2551 CANH pin to external bus (DB9 J4)†
JP13	Connects Node 1 MCP2551 CANL pin to external bus (DB9 J4)†
JP14	Connects Node 1 MCP2551 RXD pin to external bus (DB9 J4)†
JP15	Connects 120 ohm terminating resistor to the CAN bus

† These jumpers are provided to disconnect the MCP2551 device from the bus so other physical layers can be used, including a third-party daughter card available from Kvaser AB.

# MCP2515 Development Kit User's Guide

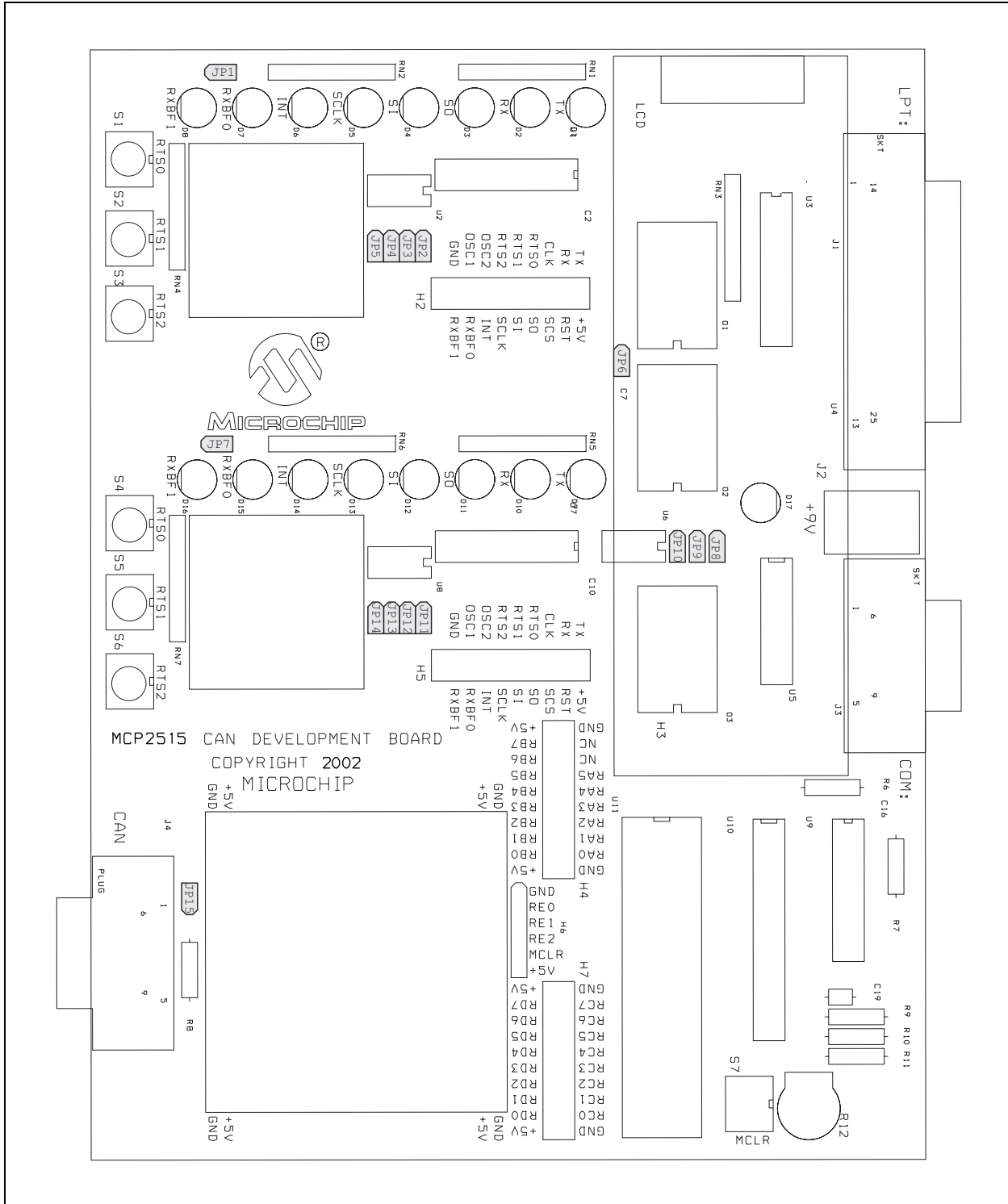

**FIGURE 5-20: JUMPER LOCATIONS**



# MCP2515 DEVELOPMENT KIT USER'S GUIDE

---

---

## Appendix A. Schematics

---

---

### A.1 INTRODUCTION

This section contains schematics, which are also available on the included CD-ROM.

# MCP2515 Development Kit User's Guide

## A.2 SCHEMATIC

**Note:** This schematic is available on the included CD-ROM (03-01522r2-S1.pdf).

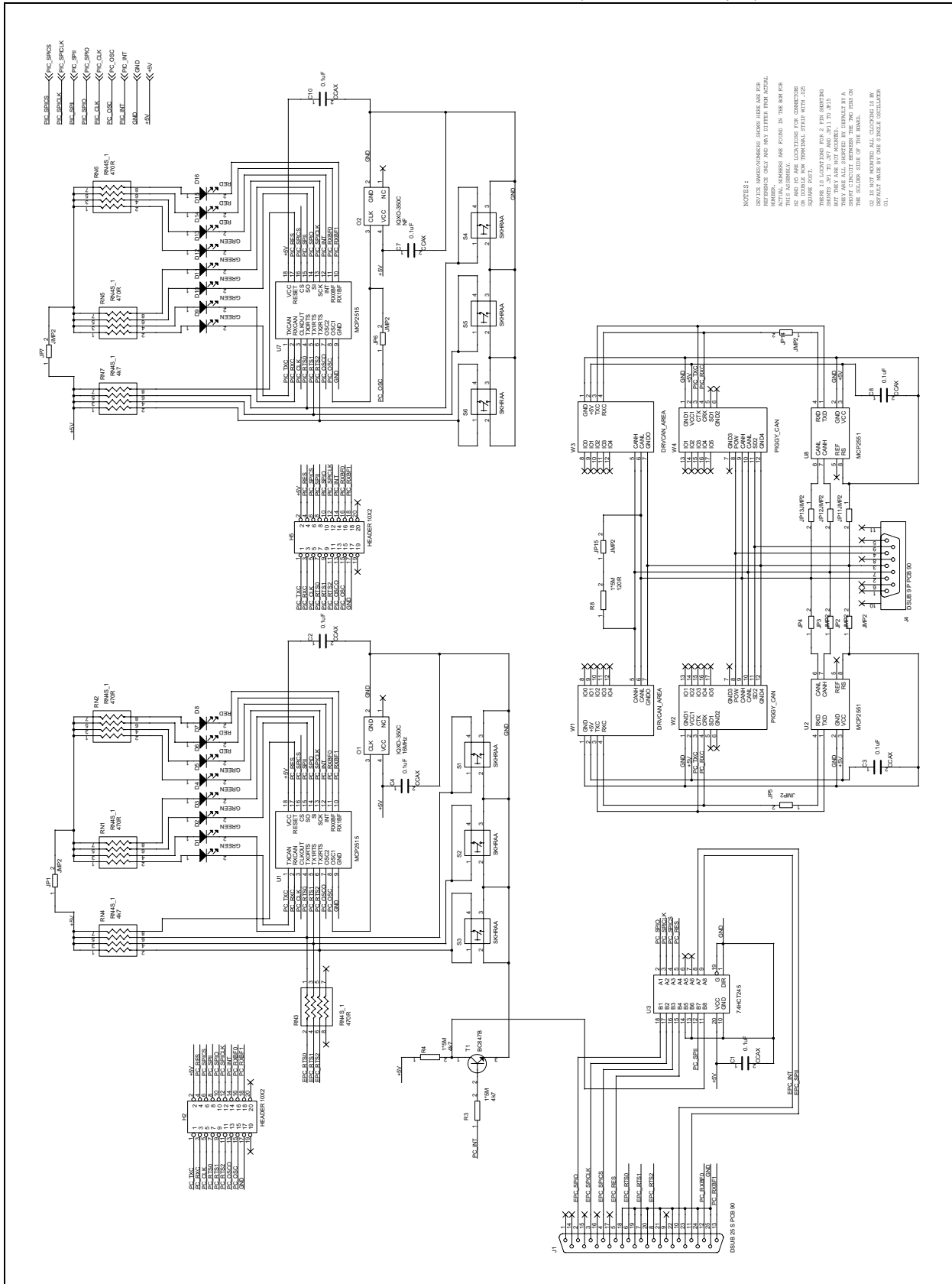

**Note:** This schematic is available on the included CD-ROM (03-01522r2-S2.pdf).

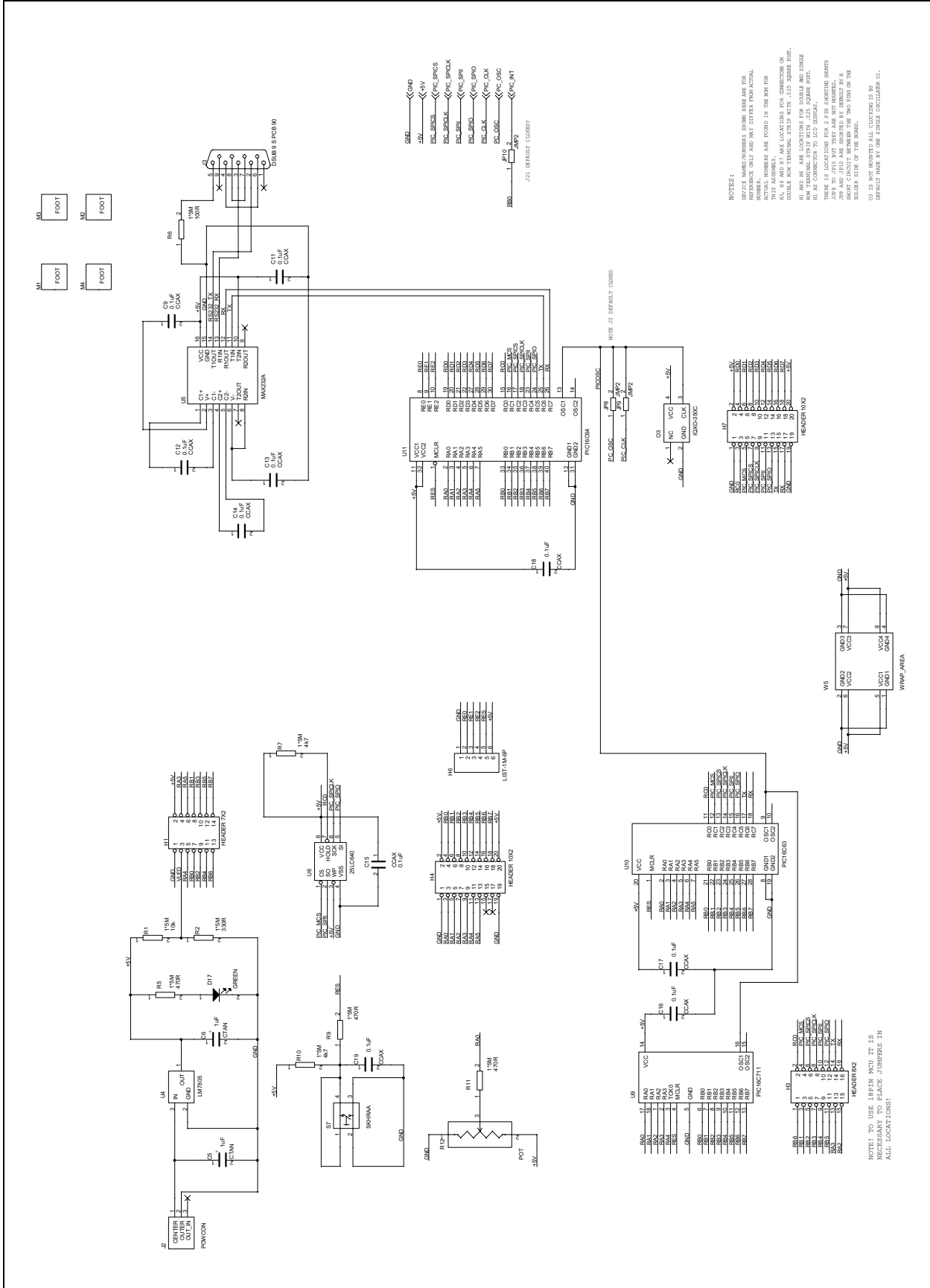

# MCP2515 Development Kit User's Guide

---

NOTES:



**Appendix B. FAQs on Configuring the MCP2515**

**B.1 INTRODUCTION**

This section answers some frequently asked questions concerning the configuration of the MCP2515 to assist those who are new to the device.

**B.2 FAQs**

**1. Why doesn't the development tool successfully communicate on an external bus?**

There are several possible reasons why this is the case. The following are the most common problems:

**TABLE B-1: COMMON BUS COMMUNICATION PROBLEMS**

Condition	Fix
The MCP2515 is off the bus (not in Normal mode).	Basic template – <b>Go on Bus</b> button in the "Bus Status" window.
The LPT port is not configured correctly.	Make sure LPT address is correct ( <i>Options &gt; MCP2515</i> ).
The bus rate is not set to match the bus.	Basic template – Set the bus rate in the Bus Status window. Register template – change CNF registers.
Oscillator frequency not set to match hardware (FOSC is required in bit rate formula).	Set the oscillator frequency ( <i>Options &gt; MCP2515...</i> ).
Board is not connected to the external bus.	Connect to the external bus using the DB9 labeled CAN. Pinouts: CANH – pin 7, CANL – pin 2.

**2. The node is acknowledging messages in the Basic template but not displaying them.**

The MCP2515 filters are not matching the incoming messages. This can occur because the Reset MCP2515 on Open is deselected, causing the old register contents (masks and filters) to remain unchanged when switching templates.

Press reset, or select the Reset MCP2515 on Open box and reopen the template.

# MCP2515 Development Kit User's Guide

---

**3. I cannot enter values in the Physical Layer window.**

The MCP2515 is not in Configuration mode. The three CNF registers are only modifiable while in Configuration mode. Change modes.

**4. The mask and filter registers do not change when pressing the Write button.**

The MCP2515 is not in Configuration mode. Masks and filters are changeable only in Configuration mode. Change mode.

**5. How do I enter extended IDs into a field?**

Lead off the number with an 'x', which indicates extended frame (e.g., x12345).

**6. Are there daughter boards available that change the physical layer?**

Yes. Contact Kvaser AB for details ([www.kvaser.se](http://www.kvaser.se)).

# FAQs on Configuring the MCP2515

---

NOTES:



## WORLDWIDE SALES AND SERVICE

### AMERICAS

#### Corporate Office

2355 West Chandler Blvd.  
Chandler, AZ 85224-6199  
Tel: 480-792-7200  
Fax: 480-792-7277  
Technical Support: 480-792-7627  
Web Address: <http://www.microchip.com>

#### Atlanta

3780 Mansell Road, Suite 130  
Alpharetta, GA 30022  
Tel: 770-640-0034  
Fax: 770-640-0307

#### Boston

2 Lan Drive, Suite 120  
Westford, MA 01886  
Tel: 978-692-3848  
Fax: 978-692-3821

#### Chicago

333 Pierce Road, Suite 180  
Itasca, IL 60143  
Tel: 630-285-0071  
Fax: 630-285-0075

#### Dallas

4570 Westgrove Drive, Suite 160  
Addison, TX 75001  
Tel: 972-818-7423  
Fax: 972-818-2924

#### Detroit

Tri-Atria Office Building  
32255 Northwestern Highway, Suite 190  
Farmington Hills, MI 48334  
Tel: 248-538-2250  
Fax: 248-538-2260

#### Kokomo

2767 S. Albright Road  
Kokomo, IN 46902  
Tel: 765-864-8360  
Fax: 765-864-8387

#### Los Angeles

18201 Von Karman, Suite 1090  
Irvine, CA 92612  
Tel: 949-263-1888  
Fax: 949-263-1338

#### Phoenix

2355 West Chandler Blvd.  
Chandler, AZ 85224-6199  
Tel: 480-792-7966  
Fax: 480-792-4338

#### San Jose

2107 North First Street, Suite 590  
San Jose, CA 95131  
Tel: 408-436-7950  
Fax: 408-436-7955

#### Toronto

6285 Northam Drive, Suite 108  
Mississauga, Ontario L4V 1X5, Canada  
Tel: 905-673-0699  
Fax: 905-673-6509

### ASIA/PACIFIC

#### Australia

Suite 22, 41 Rawson Street  
Epping 2121, NSW  
Australia  
Tel: 61-2-9868-6733  
Fax: 61-2-9868-6755

#### China - Beijing

Unit 915  
Bei Hai Wan Tai Bldg.  
No. 6 Chaoyangmen Beidajie  
Beijing, 100027, No. China  
Tel: 86-10-85282100  
Fax: 86-10-85282104

#### China - Chengdu

Rm. 2401-2402, 24th Floor,  
Ming Xing Financial Tower  
No. 88 TIDU Street  
Chengdu 610016, China  
Tel: 86-28-86766200  
Fax: 86-28-86766599

#### China - Fuzhou

Unit 28F, World Trade Plaza  
No. 71 Wusi Road  
Fuzhou 350001, China  
Tel: 86-591-7503506  
Fax: 86-591-7503521

#### China - Hong Kong SAR

Unit 901-6, Tower 2, Metroplaza  
223 Hing Fong Road  
Kwai Fong, N.T., Hong Kong  
Tel: 852-2401-1200  
Fax: 852-2401-3431

#### China - Shanghai

Room 701, Bldg. B  
Far East International Plaza  
No. 317 Xian Xia Road  
Shanghai, 200051  
Tel: 86-21-6275-5700  
Fax: 86-21-6275-5060

#### China - Shenzhen

Rm. 1812, 18/F, Building A, United Plaza  
No. 5022 Binhe Road, Futian District  
Shenzhen 518033, China  
Tel: 86-755-82901380  
Fax: 86-755-8295-1393

#### China - Shunde

Room 401, Hongjian Building  
No. 2 Fengxiangnan Road, Ronggui Town  
Shunde City, Guangdong 528303, China  
Tel: 86-765-8395507 Fax: 86-765-8395571

#### China - Qingdao

Rm. B505A, Fullhope Plaza,  
No. 12 Hong Kong Central Rd.  
Qingdao 266071, China  
Tel: 86-532-5027355 Fax: 86-532-5027205

#### India

Divyasree Chambers  
1 Floor, Wing A (A3/A4)  
No. 11, O'Shaughnessy Road  
Bangalore, 560 025, India  
Tel: 91-80-2290061 Fax: 91-80-2290062

#### Japan

Benex S-1 6F  
3-18-20, Shinyokohama  
Kohoku-Ku, Yokohama-shi  
Kanagawa, 222-0033, Japan  
Tel: 81-45-471-6166 Fax: 81-45-471-6122

### Korea

168-1, Youngbo Bldg. 3 Floor  
Samsung-Dong, Kangnam-Ku  
Seoul, Korea 135-882  
Tel: 82-2-554-7200 Fax: 82-2-558-5932 or  
82-2-558-5934

### Singapore

200 Middle Road  
#07-02 Prime Centre  
Singapore, 188980  
Tel: 65-6334-8870 Fax: 65-6334-8850

### Taiwan

Kaohsiung Branch  
30F - 1 No. 8  
Min Chuan 2nd Road  
Kaohsiung 806, Taiwan  
Tel: 886-7-536-4818  
Fax: 886-7-536-4803

### Taiwan

Taiwan Branch  
11F-3, No. 207  
Tung Hua North Road  
Taipei, 105, Taiwan  
Tel: 886-2-2717-7175 Fax: 886-2-2545-0139

### EUROPE

#### Austria

Durisolstrasse 2  
A-4600 Wels  
Austria  
Tel: 43-7242-2244-399  
Fax: 43-7242-2244-393

#### Denmark

Regus Business Centre  
Lautrup høj 1-3  
Ballerup DK-2750 Denmark  
Tel: 45-4420-9895 Fax: 45-4420-9910

#### France

Parc d'Activite du Moulin de Massy  
43 Rue du Saule Trapu  
Batiment A - ler Etage  
91300 Massy, France  
Tel: 33-1-69-53-63-20  
Fax: 33-1-69-30-90-79

#### Germany

Steinheilstrasse 10  
D-85737 Ismaning, Germany  
Tel: 49-89-627-144-0  
Fax: 49-89-627-144-44

#### Italy

Via Quasimodo, 12  
20025 Legnano (MI)  
Milan, Italy  
Tel: 39-0331-742611  
Fax: 39-0331-466781

#### Netherlands

P. A. De Biesbosch 14  
NL-5152 SC Drunen, Netherlands  
Tel: 31-416-690399  
Fax: 31-416-690340

#### United Kingdom

505 Eskdale Road  
Winnersh Triangle  
Wokingham  
Berkshire, England RG41 5TU  
Tel: 44-118-921-5869  
Fax: 44-118-921-5820

07/28/03