

## FLLD3055AMHT5

Aliases (LLD3055AMHT5)

KEMET, FLLD3-MH, EMI/RFI Filters, Noise Suppression, 530 VAC, 55 A, 220x85x90mm

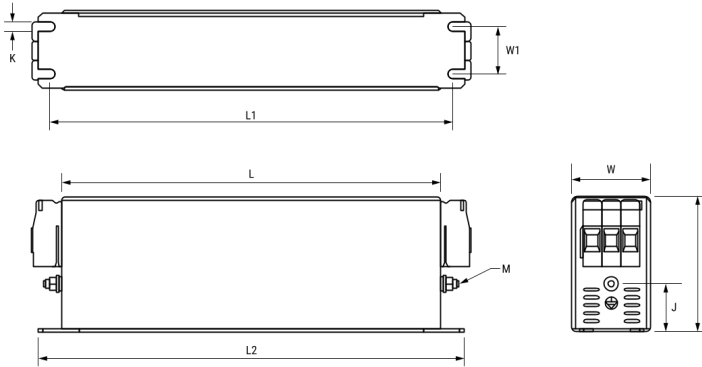

Click [here](#) for the 3D model.

### Dimensions

L	220mm NOM
W	85mm NOM
H	90mm NOM
L1	235mm NOM
L2	250mm NOM
W1	60mm NOM
J	26mm NOM
K	5.5mm NOM
M (Earth)	Threaded Studs M6

### Packaging Specifications

Packaging	Bulk
Packaging Quantity	1
Component Weight	2000 g

### General Information

Series	FLLD3-MH
Style	Chassis Mount
Description	EMI Filter, Chassis Mount, Motor Drives
Features	Three Phase, High Performance, High Voltage
Phase	Three-phase
RoHS	Yes
Qualifications	IEC/EN 60939, UL 1283
Terminal Type	Threaded Studs M6

### Specifications

Voltage AC	530 VAC, 305 VAC
Rated Frequency	50-60 Hz
Rated Current	55 A (50°C)
Rated Temperature	50°C
Temperature Range	-25/+100°C
Climate Category	25/100/21
Test Voltage DC (P to P)	2250 VDC
Test Voltage DC (P to E)	3000 VDC
Power Loss	20 W (25°C 50 Hz)
Leakage Current	4.7 mA