

CSD16321Q5 25-V N-Channel NexFET™ Power MOSFET

1 Features

- Optimized for 5-V Gate Drive
- Ultra-Low Q_g and Q_{gd}
- Low-Thermal Resistance
- Avalanche Rated
- Lead-Free Terminal Plating
- RoHS Compliant
- SON 5-mm x 6-mm Plastic Package

2 Applications

- Point-of-Load Synchronous Buck Converter for Applications in Networking, Telecom, and Computing Systems
- Optimized for Synchronous FET Applications

3 Description

This 25-V, 1.9-m Ω , 5-mm x 6-mm SON NexFET™ power MOSFET has been designed to minimize losses in power conversion and optimized for 5-V gate drive applications.

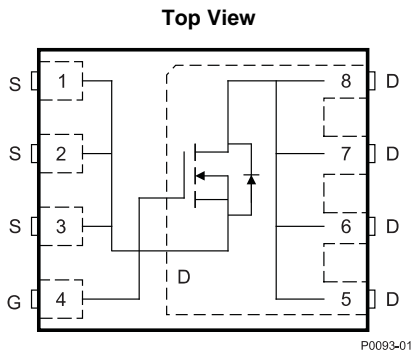

Product Summary

$T_A = 25^\circ\text{C}$		TYPICAL VALUE		UNIT
V_{DS}	Drain-to-Source Voltage	25		V
Q_g	Gate Charge Total (4.5 V)	14		nC
Q_{gd}	Gate Charge Gate-to-Drain	2.5		nC
$R_{DS(on)}$	Drain-to-Source On Resistance	$V_{GS} = 3\text{ V}$	2.8	m Ω
		$V_{GS} = 4.5\text{ V}$	2.1	
		$V_{GS} = 8\text{ V}$	1.9	
$V_{GS(th)}$	Threshold Voltage	1.1		V

Device Information⁽¹⁾

DEVICE	MEDIA	QTY	PACKAGE	SHIP
CSD16321Q5	13-Inch Reel	2500	SON	Tape and Reel
CSD16321Q5T	7-Inch Reel	250	5.00-mm x 6.00-mm Plastic Package	Tape and Reel

(1) For all available packages, see the orderable addendum at the end of the data sheet.

Absolute Maximum Ratings

$T_A = 25^\circ\text{C}$		VALUE	UNIT
V_{DS}	Drain-to-Source Voltage	25	V
V_{GS}	Gate-to-Source Voltage	+10 / -8	V
I_D	Continuous Drain Current (Package Limited)	100	A
	Continuous Drain Current (Silicon Limited), $T_C = 25^\circ\text{C}$	177	
	Continuous Drain Current ⁽¹⁾	29	
I_{DM}	Pulsed Drain Current ⁽²⁾	400	A
P_D	Power Dissipation ⁽¹⁾	3.1	W
	Power Dissipation, $T_C = 25^\circ\text{C}$	113	
T_J, T_{stg}	Operating Junction, Storage Temperature	-55 to 150	$^\circ\text{C}$
E_{AS}	Avalanche Energy, Single Pulse $I_D = 66\text{ A}, L = 0.1\text{ mH}, R_G = 25\ \Omega$	218	mJ

(1) Typical $R_{\theta JA} = 40^\circ\text{C/W}$ on 1-in², 2-oz Cu pad on 0.06-in thick FR4 PCB.

(2) Max $R_{\theta JC} = 1.1^\circ\text{C/W}$, pulse duration $\leq 100\ \mu\text{s}$, duty cycle $\leq 1\%$.

$R_{DS(ON)}$ vs V_{GS}

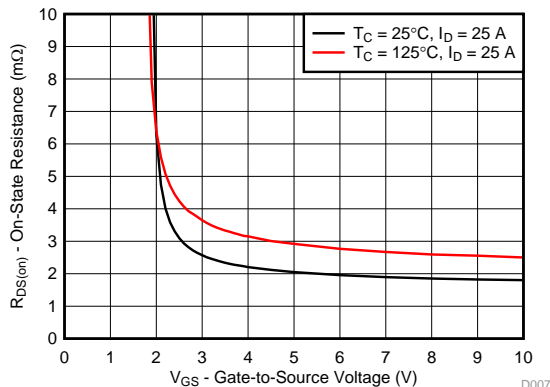

Gate Charge

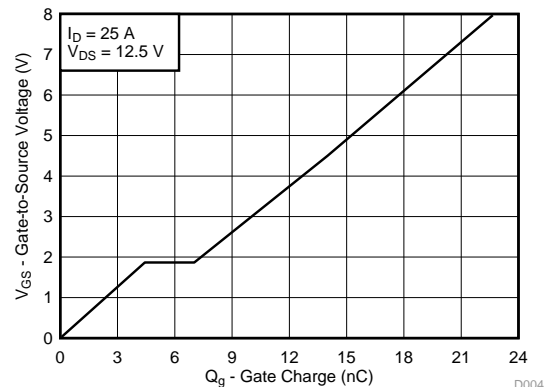

Table of Contents

1 Features 1 2 Applications 1 3 Description 1 4 Revision History 2 5 Specifications 3 5.1 Electrical Characteristics 3 5.2 Thermal Information 3 5.3 Typical MOSFET Characteristics 4 6 Device and Documentation Support 7	6.1 Receiving Notification of Documentation Updates 7 6.2 Community Resources 7 6.3 Trademarks 7 6.4 Electrostatic Discharge Caution 7 6.5 Glossary 7 7 Mechanical, Packaging, and Orderable Information 8 7.1 Q5 Package Dimensions 8 7.2 Recommended PCB Pattern 9 7.3 Q5 Tape and Reel Information 10
--	--

4 Revision History

NOTE: Page numbers for previous revisions may differ from page numbers in the current version.

Changes from Revision C (December 2016) to Revision D Page

<ul style="list-style-type: none"> • Changed the $R_{DS(ON)}$ values at 3 V, 4.5 V, 8 V & the <i>Description</i> to match the values on the <i>Electrical Characteristics</i> table. 	1
---	---

Changes from Revision B (May 2010) to Revision C Page

<ul style="list-style-type: none"> • Changed <i>Description</i> text • Added silicon limited continuous drain current to <i>Absolute Maximum Ratings</i> table • Added max power dissipation at $T_C = 25^\circ\text{C}$ to <i>Absolute Maximum Ratings</i> table • Changed Note 2 in <i>Absolute Maximum Ratings</i> table • Changed $R_{\theta JA}$ max from 48°C/W : to 50°C/W • Changed the SOA in Figure 10 to reflect measured data • Added <i>Device and Documentation Support</i> section • Changed <i>MECHANICAL DATA</i> section to <i>Mechanical, Packaging, and Orderable Information</i> section 	1 1 1 1 3 6 7 8
---	--------------------------------------

Changes from Revision A (January 2010) to Revision B Page

<ul style="list-style-type: none"> • Changed $R_{DS(on)} - V_{GS} = 3\text{ V}, I_D = 25\text{ A}$ MAX value From: 3.5 To: 3.8 • Deleted the Package Marking Information section 	3 10
---	---------

Changes from Original (August 2009) to Revision A Page

<ul style="list-style-type: none"> • Changed the labels on the Top View pinout image • Changed Note 1 of the From: $R_{\theta JA} = 39^\circ\text{C/W}$ To: Typical $R_{\theta JA} = 39^\circ\text{C/W}$ • Changed Figure 1 text From: $R_{\theta JA} = 92^\circ\text{C/W}$ To: Typical $R_{\theta JA} = 93^\circ\text{C/W}$ • Changed Figure 10 text From: $R_{\theta JA} = 92^\circ\text{C/W}$ To: Typical $R_{\theta JA} = 93^\circ\text{C/W}$ • Changed Figure 11 X-axis values 	1 1 4 5 5
--	-----------------------

5 Specifications

5.1 Electrical Characteristics

 $T_A = 25^\circ\text{C}$ (unless otherwise stated)

PARAMETER		TEST CONDITIONS	MIN	TYP	MAX	UNIT
STATIC CHARACTERISTICS						
BV_{DSS}	Drain-to-source voltage	$V_{GS} = 0\text{ V}, I_D = 250\ \mu\text{A}$	25			V
I_{DSS}	Drain-to-source leakage current	$V_{GS} = 0\text{ V}, V_{DS} = 20\text{ V}$			1	μA
I_{GSS}	Gate-to-source leakage current	$V_{DS} = 0\text{ V}, V_{GS} = +10 / -8\text{ V}$			100	nA
$V_{GS(th)}$	Gate-to-source threshold voltage	$V_{DS} = V_{GS}, I_D = 250\ \mu\text{A}$	0.9	1.1	1.4	V
$R_{DS(on)}$	Drain-to-source on resistance	$V_{GS} = 3\text{ V}, I_D = 25\text{ A}$		2.8	3.8	m Ω
		$V_{GS} = 4.5\text{ V}, I_D = 25\text{ A}$		2.1	2.6	
		$V_{GS} = 8\text{ V}, I_D = 25\text{ A}$		1.9	2.4	
g_{fs}	Transconductance	$V_{DS} = 12.5\text{ V}, I_D = 25\text{ A}$		150		S
DYNAMIC CHARACTERISTICS						
C_{iss}	Input capacitance	$V_{GS} = 0\text{ V}, V_{DS} = 12.5\text{ V}, f = 1\text{ MHz}$		2360	3100	pF
C_{oss}	Output capacitance			1700	2200	pF
C_{rss}	Reverse transfer capacitance			115	150	pF
R_G	Series gate resistance			1.5	3	Ω
Q_g	Gate charge total (4.5 V)	$V_{DS} = 12.5\text{ V}, I_D = 25\text{ A}$		14	19	nC
Q_{gd}	Gate charge gate-to-drain			2.5		nC
Q_{gs}	Gate charge gate-to-source			4		nC
$Q_{g(th)}$	Gate charge at V_{th}			2.1		nC
Q_{oss}	Output charge	$V_{DS} = 15\text{ V}, V_{GS} = 0\text{ V}$		36		nC
$t_{d(on)}$	Turnon delay time	$V_{DS} = 12.5\text{ V}, V_{GS} = 4.5\text{ V}, I_D = 25\text{ A}, R_G = 2\ \Omega$		9		ns
t_r	Rise time			15		ns
$t_{d(off)}$	Turnoff delay time			27		ns
t_f	Fall time			17		ns
DIODE CHARACTERISTICS						
V_{SD}	Diode forward voltage	$I_{SD} = 25\text{ A}, V_{GS} = 0\text{ V}$		0.8	1	V
Q_{rr}	Reverse recovery charge	$V_{DD} = 13\text{ V}, I_F = 25\text{ A}, di/dt = 300\text{ A}/\mu\text{s}$		33		nC
t_{rr}	Reverse recovery time	$V_{DD} = 13\text{ V}, I_F = 25\text{ A}, di/dt = 300\text{ A}/\mu\text{s}$		32		ns

5.2 Thermal Information

 $T_A = 25^\circ\text{C}$ (unless otherwise stated)

PARAMETER		MIN	TYP	MAX	UNIT
$R_{\theta JC}$	Junction-to-case thermal resistance ⁽¹⁾			1.1	$^\circ\text{C}/\text{W}$
$R_{\theta JA}$	Junction-to-ambient thermal resistance ^{(1) (2)}			50	$^\circ\text{C}/\text{W}$

- (1) $R_{\theta JC}$ is determined with the device mounted on a 1-in², 2-oz Cu pad on a 1.5-in × 1.5-in, 0.06-in thick FR4 board. $R_{\theta JC}$ is specified by design while $R_{\theta JA}$ is determined by the user's board design.
- (2) Device mounted on FR4 Material with 1 in² of 2-oz Cu.

CSD16321Q5

SLPS220D – AUGUST 2009 – REVISED MAY 2017

www.ti.com



M0137-01

Max $R_{\theta JA} = 50^{\circ}\text{C/W}$
when mounted on 1 in²
of 2-oz Cu.



M0137-02

Max $R_{\theta JA} = 125^{\circ}\text{C/W}$
when mounted on
minimum pad area of
2-oz Cu.

5.3 Typical MOSFET Characteristics

$T_A = 25^{\circ}\text{C}$ (unless otherwise stated)

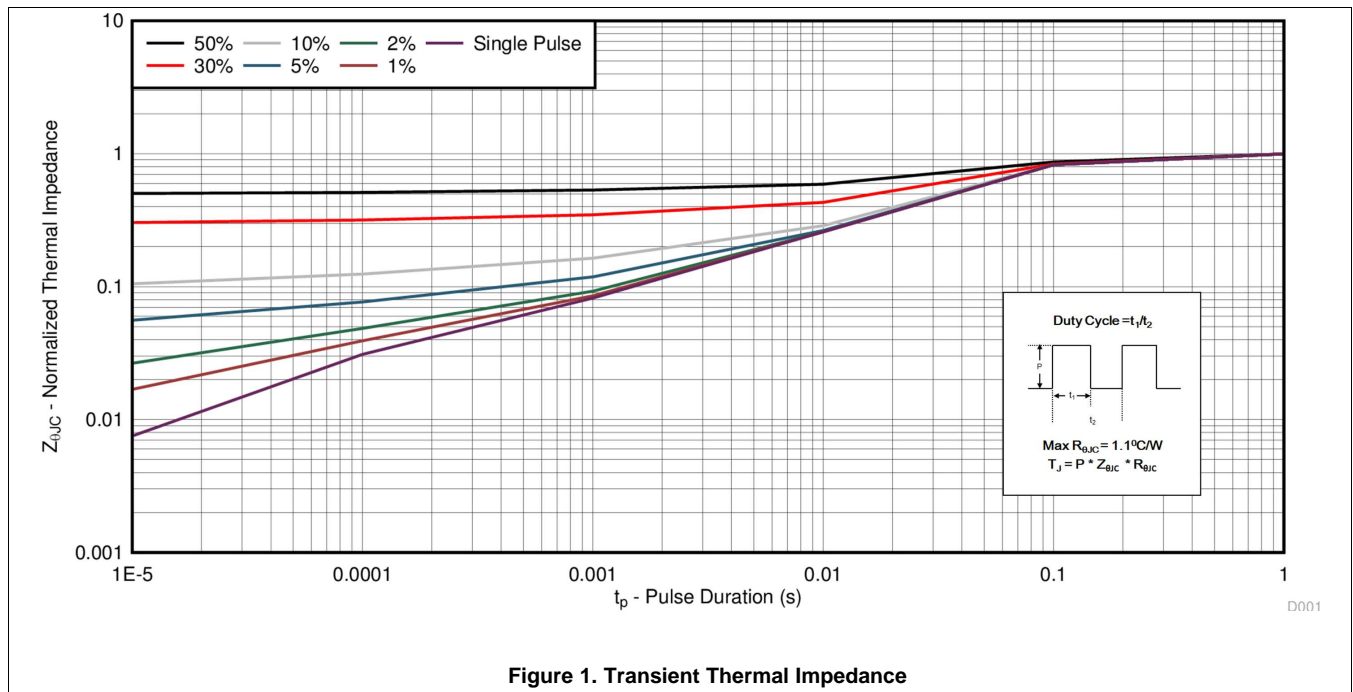
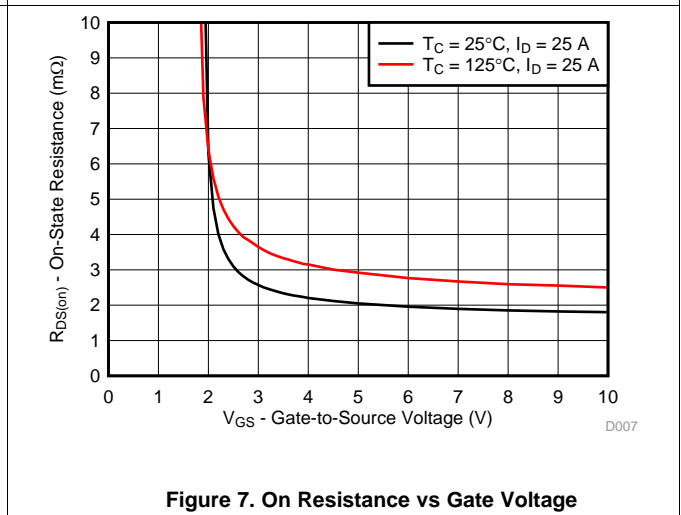
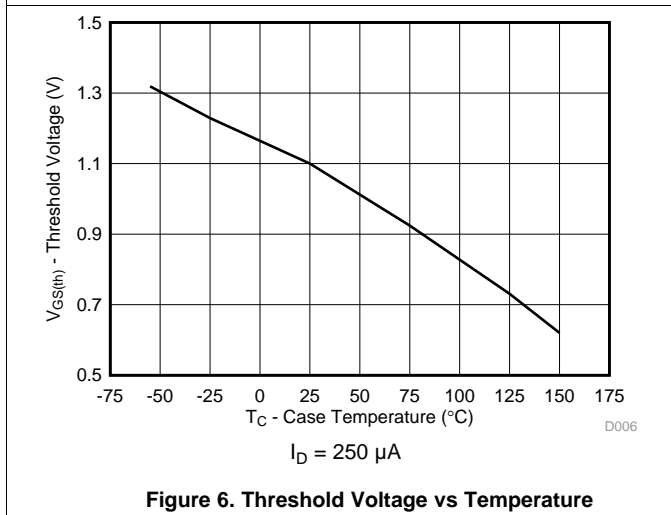
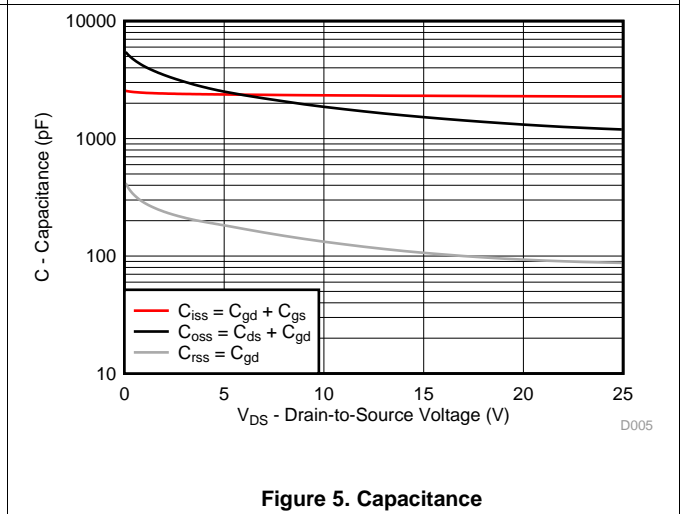
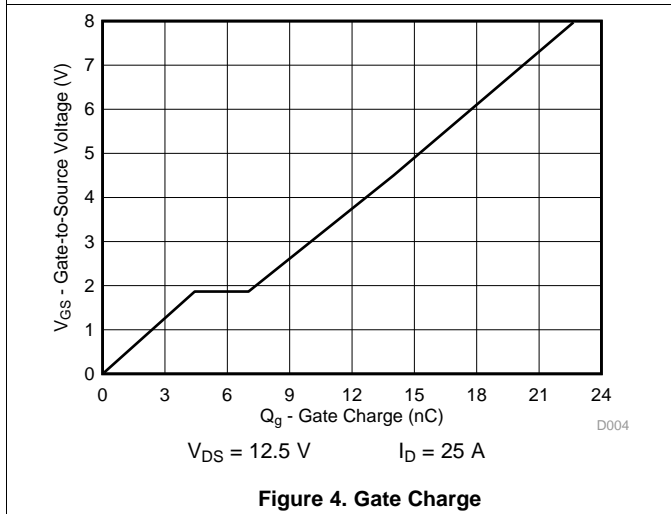
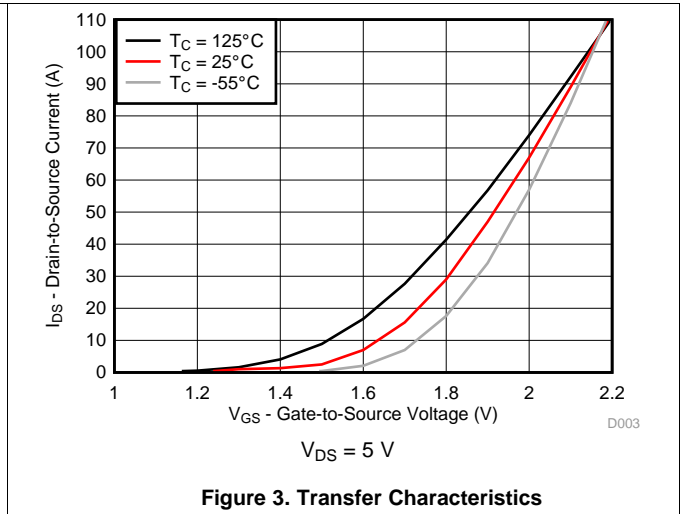
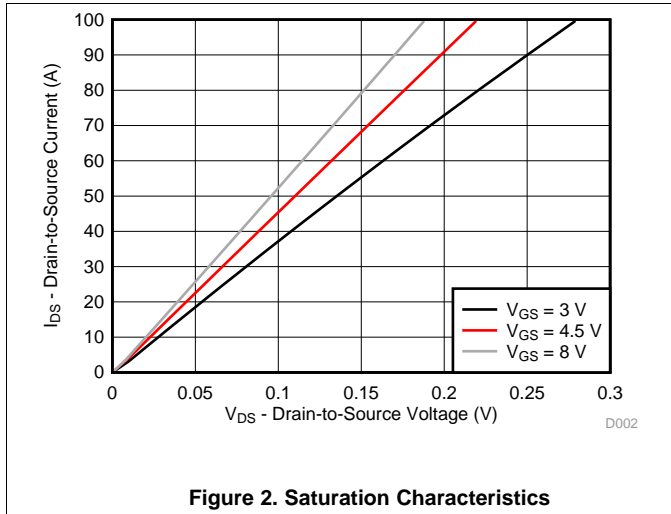

Figure 1. Transient Thermal Impedance

Typical MOSFET Characteristics (continued)

$T_A = 25^\circ\text{C}$ (unless otherwise stated)



Typical MOSFET Characteristics (continued)

$T_A = 25^\circ\text{C}$ (unless otherwise stated)

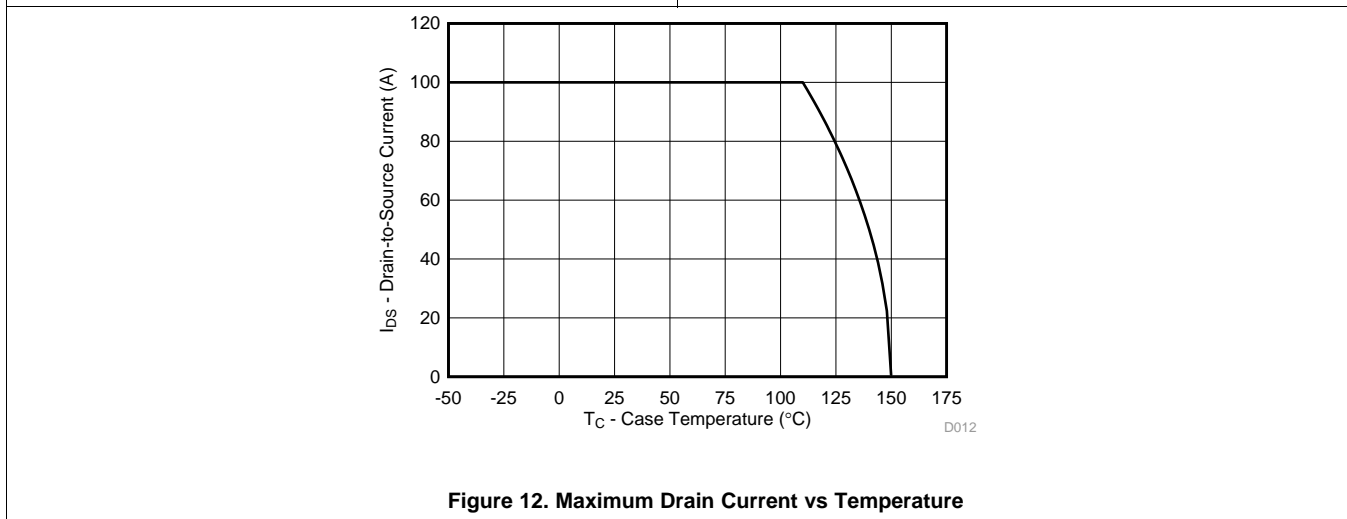
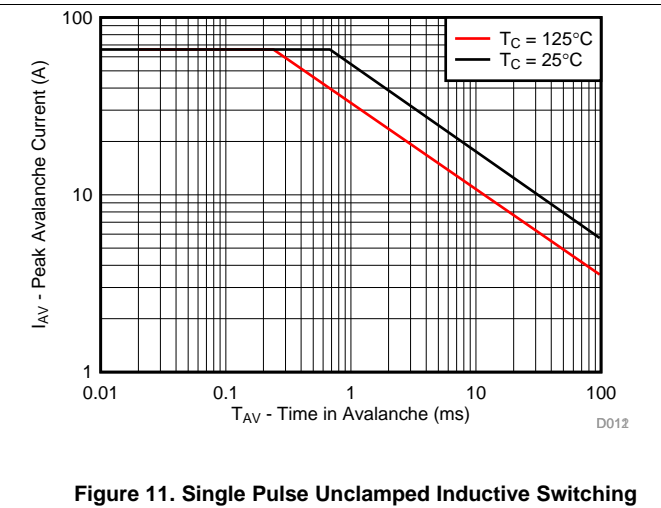
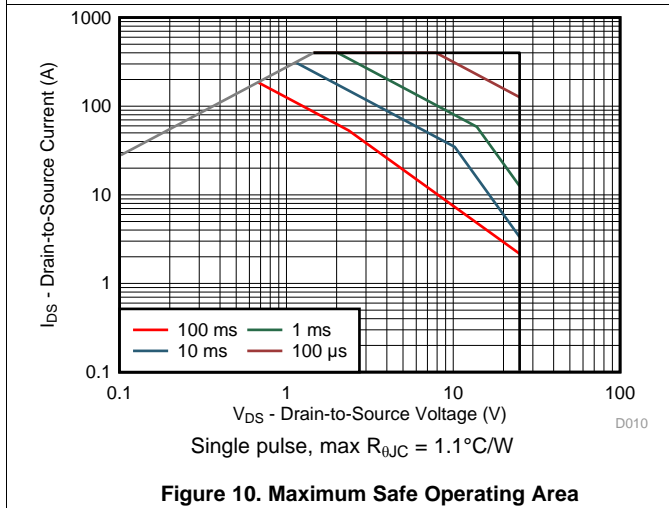
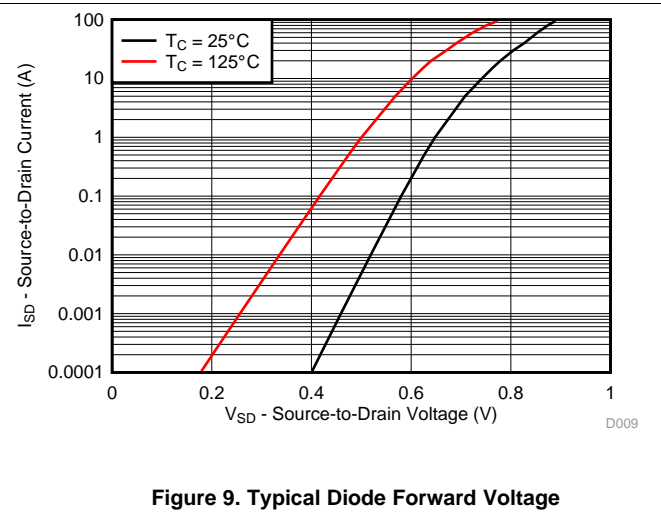
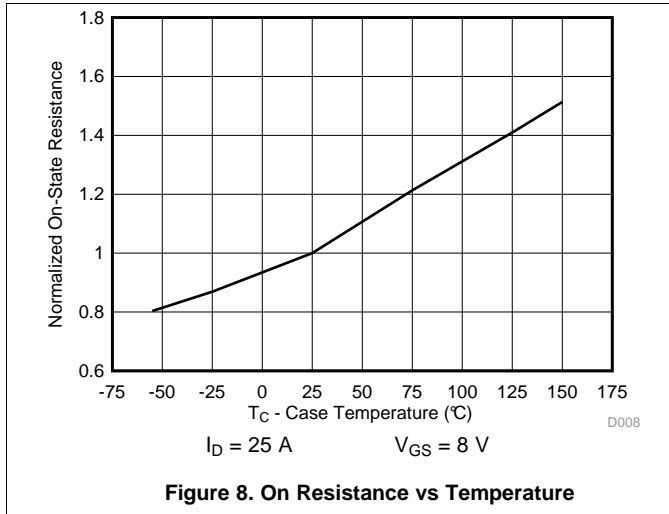

6 Device and Documentation Support

6.1 Receiving Notification of Documentation Updates

To receive notification of documentation updates, navigate to the device product folder on ti.com. In the upper right corner, click on *Alert me* to register and receive a weekly digest of any product information that has changed. For change details, review the revision history included in any revised document.

6.2 Community Resources

The following links connect to TI community resources. Linked contents are provided "AS IS" by the respective contributors. They do not constitute TI specifications and do not necessarily reflect TI's views; see TI's [Terms of Use](#).

TI E2E™ Online Community *TI's Engineer-to-Engineer (E2E) Community*. Created to foster collaboration among engineers. At e2e.ti.com, you can ask questions, share knowledge, explore ideas and help solve problems with fellow engineers.

Design Support *TI's Design Support* Quickly find helpful E2E forums along with design support tools and contact information for technical support.

6.3 Trademarks

NexFET, E2E are trademarks of Texas Instruments.
All other trademarks are the property of their respective owners.

6.4 Electrostatic Discharge Caution



These devices have limited built-in ESD protection. The leads should be shorted together or the device placed in conductive foam during storage or handling to prevent electrostatic damage to the MOS gates.

6.5 Glossary

[SLYZ022](#) — *TI Glossary*.

This glossary lists and explains terms, acronyms, and definitions.

7 Mechanical, Packaging, and Orderable Information

The following pages include mechanical, packaging, and orderable information. This information is the most current data available for the designated devices. This data is subject to change without notice and revision of this document. For browser-based versions of this data sheet, refer to the left-hand navigation.

7.1 Q5 Package Dimensions

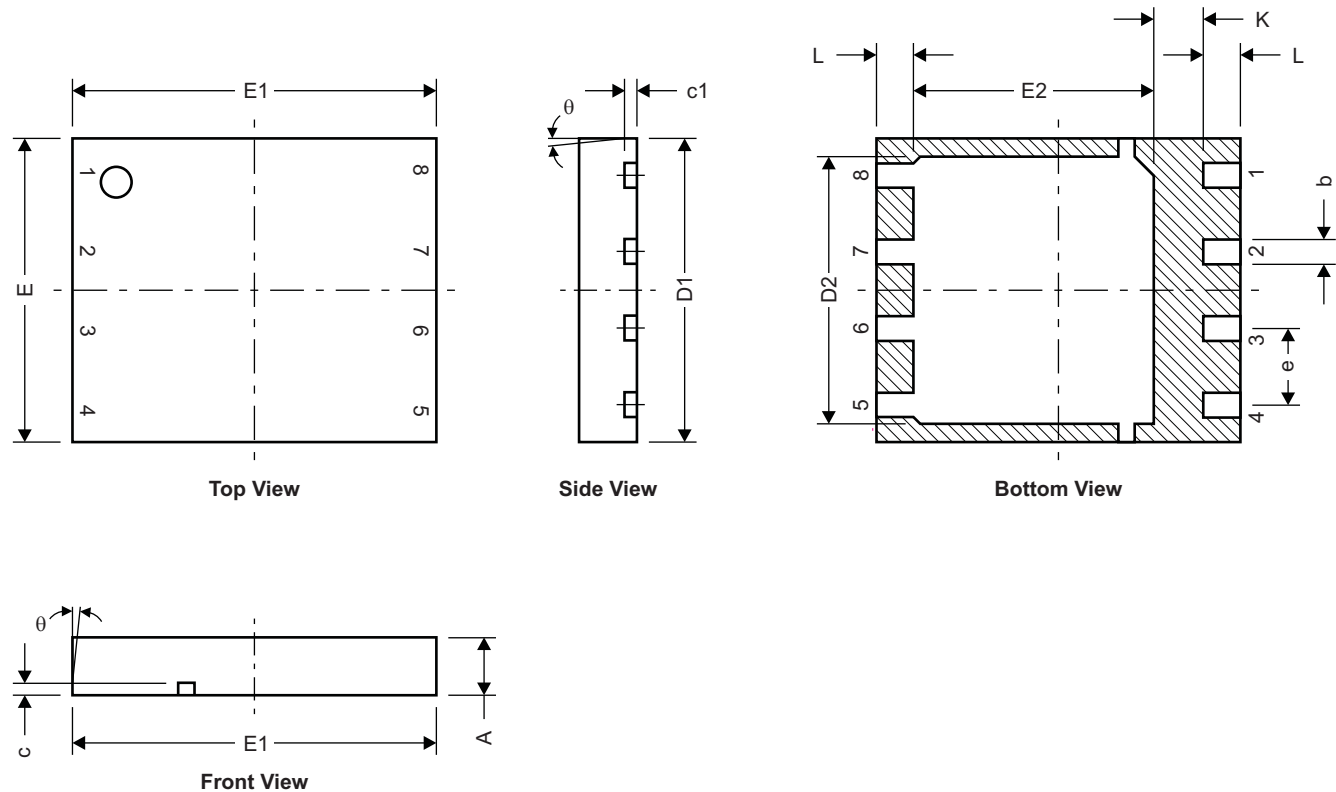

M0140-01

DIM	MILLIMETERS		INCHES	
	MIN	MAX	MIN	MAX
A	0.950	1.050	0.037	0.039
b	0.360	0.460	0.014	0.018
c	0.150	0.250	0.006	0.010
c1	0.150	0.250	0.006	0.010
D1	4.900	5.100	0.193	0.201
D2	4.320	4.520	0.170	0.178
E	4.900	5.100	0.193	0.201
E1	5.900	6.100	0.232	0.240
E2	3.920	4.12	0.154	0.162
e	1.27 TYP		0.050 TYP	
K	0.760	—	0.030	—
L	0.510	0.710	0.020	0.028
θ	0.00	—	—	—

7.3 Q5 Tape and Reel Information

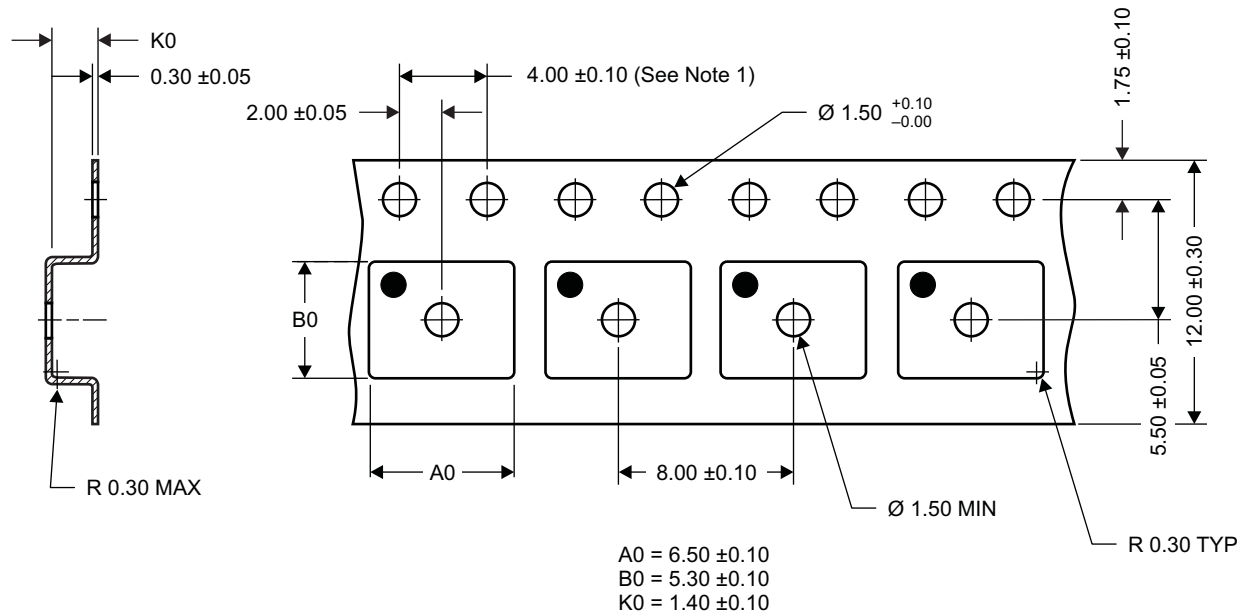



M0138-01

Notes:

1. 10-sprocket hole pitch cumulative tolerance ± 0.2 .
2. Camber not to exceed 1 mm in 100 mm, noncumulative over 250 mm.
3. Material: black static dissipative polystyrene.
4. All dimensions are in mm (unless otherwise specified).
5. Thickness: 0.30 ± 0.05 mm.
6. MSL1 260°C (IR and Convection) PbF Reflow Compatible.

PACKAGING INFORMATION

Orderable Device	Status (1)	Package Type	Package Drawing	Pins	Package Qty	Eco Plan (2)	Lead finish/ Ball material (6)	MSL Peak Temp (3)	Op Temp (°C)	Device Marking (4/5)	Samples
CSD16321Q5	ACTIVE	VSON-CLIP	DQH	8	2500	RoHS-Exempt & Green	SN	Level-1-260C-UNLIM	-55 to 150	CSD16321	
CSD16321Q5T	ACTIVE	VSON-CLIP	DQH	8	250	RoHS-Exempt & Green	SN	Level-1-260C-UNLIM	-55 to 150	CSD16321	

(1) The marketing status values are defined as follows:

ACTIVE: Product device recommended for new designs.

LIFEBUY: TI has announced that the device will be discontinued, and a lifetime-buy period is in effect.

NRND: Not recommended for new designs. Device is in production to support existing customers, but TI does not recommend using this part in a new design.

PREVIEW: Device has been announced but is not in production. Samples may or may not be available.

OBSOLETE: TI has discontinued the production of the device.

(2) **RoHS:** TI defines "RoHS" to mean semiconductor products that are compliant with the current EU RoHS requirements for all 10 RoHS substances, including the requirement that RoHS substance do not exceed 0.1% by weight in homogeneous materials. Where designed to be soldered at high temperatures, "RoHS" products are suitable for use in specified lead-free processes. TI may reference these types of products as "Pb-Free".

RoHS Exempt: TI defines "RoHS Exempt" to mean products that contain lead but are compliant with EU RoHS pursuant to a specific EU RoHS exemption.

Green: TI defines "Green" to mean the content of Chlorine (Cl) and Bromine (Br) based flame retardants meet JS709B low halogen requirements of <=1000ppm threshold. Antimony trioxide based flame retardants must also meet the <=1000ppm threshold requirement.

(3) MSL, Peak Temp. - The Moisture Sensitivity Level rating according to the JEDEC industry standard classifications, and peak solder temperature.

(4) There may be additional marking, which relates to the logo, the lot trace code information, or the environmental category on the device.

(5) Multiple Device Markings will be inside parentheses. Only one Device Marking contained in parentheses and separated by a "~" will appear on a device. If a line is indented then it is a continuation of the previous line and the two combined represent the entire Device Marking for that device.

(6) Lead finish/Ball material - Orderable Devices may have multiple material finish options. Finish options are separated by a vertical ruled line. Lead finish/Ball material values may wrap to two lines if the finish value exceeds the maximum column width.

Important Information and Disclaimer:The information provided on this page represents TI's knowledge and belief as of the date that it is provided. TI bases its knowledge and belief on information provided by third parties, and makes no representation or warranty as to the accuracy of such information. Efforts are underway to better integrate information from third parties. TI has taken and continues to take reasonable steps to provide representative and accurate information but may not have conducted destructive testing or chemical analysis on incoming materials and chemicals. TI and TI suppliers consider certain information to be proprietary, and thus CAS numbers and other limited information may not be available for release.

In no event shall TI's liability arising out of such information exceed the total purchase price of the TI part(s) at issue in this document sold by TI to Customer on an annual basis.

IMPORTANT NOTICE AND DISCLAIMER

TI PROVIDES TECHNICAL AND RELIABILITY DATA (INCLUDING DATA SHEETS), DESIGN RESOURCES (INCLUDING REFERENCE DESIGNS), APPLICATION OR OTHER DESIGN ADVICE, WEB TOOLS, SAFETY INFORMATION, AND OTHER RESOURCES "AS IS" AND WITH ALL FAULTS, AND DISCLAIMS ALL WARRANTIES, EXPRESS AND IMPLIED, INCLUDING WITHOUT LIMITATION ANY IMPLIED WARRANTIES OF MERCHANTABILITY, FITNESS FOR A PARTICULAR PURPOSE OR NON-INFRINGEMENT OF THIRD PARTY INTELLECTUAL PROPERTY RIGHTS.

These resources are intended for skilled developers designing with TI products. You are solely responsible for (1) selecting the appropriate TI products for your application, (2) designing, validating and testing your application, and (3) ensuring your application meets applicable standards, and any other safety, security, regulatory or other requirements.

These resources are subject to change without notice. TI grants you permission to use these resources only for development of an application that uses the TI products described in the resource. Other reproduction and display of these resources is prohibited. No license is granted to any other TI intellectual property right or to any third party intellectual property right. TI disclaims responsibility for, and you will fully indemnify TI and its representatives against, any claims, damages, costs, losses, and liabilities arising out of your use of these resources.

TI's products are provided subject to [TI's Terms of Sale](#) or other applicable terms available either on ti.com or provided in conjunction with such TI products. TI's provision of these resources does not expand or otherwise alter TI's applicable warranties or warranty disclaimers for TI products.

TI objects to and rejects any additional or different terms you may have proposed.

Mailing Address: Texas Instruments, Post Office Box 655303, Dallas, Texas 75265
Copyright © 2022, Texas Instruments Incorporated