

SupIRBuck™

USER GUIDE FOR IRDC3477 EVALUATION BOARD

DESCRIPTION

The IR3477 SupIRBuck™ is an easy-to-use, fully integrated and highly efficient DC/DC voltage regulator. The onboard constant on time hysteretic controller and MOSFETs make IR3477 a space-efficient solution that delivers up to 15A of precisely controlled output voltage. IR3477 is housed in a 20-lead 5mmx6mm QFN package.

Key features offered by IR3477 include: programmable switching frequency, soft start, temperature compensated over current protection, and thermal shutdown allowing a very flexible solution suitable for many different applications and an ideal choice for battery powered applications.

Additional features include pre-bias startup, a very precise 0.5V reference, forced continuous conduction mode option, over/under voltage protection, power good output, and enable input with voltage monitoring capability.

This user guide contains the schematic, bill of materials, and operating instructions of the IRDC3477 evaluation board. Detailed product specifications, application information and performance curves at different operating conditions are available in the IR3477 data sheet.

BOARD FEATURES

- $V_{IN} = +12V$
- $V_{CC} = +5V$
- $V_{OUT} = +1.05V$
- $I_{OUT} = 0$ to 15A
- $F_S = 300kHz @ CCM$
- $L = 1\mu H$
- $C_{IN} = 22\mu F$ (ceramic 1210) + $68\mu F$ (electrolytic)
- $C_{OUT} = 47\mu F$ (ceramic 0805) + $330\mu F$ (PC-CON)

CONNECTIONS and OPERATING INSTRUCTIONS

An input supply in the range of 8 to 19V should be connected from VIN to PGND. A maximum load of 15A may be connected to V_{OUT} and PGND. The connection diagram is shown in Fig. 1, and the inputs and outputs of the board are listed in Table 1.

IRDC3477 has two input supplies, one for biasing (VCC) and the other for input voltage (VIN). Separate supplies should be applied to these inputs. VCC input should be a well regulated 4.5V to 5.5V supply connected to VCC and PGND. Enable (EN) is controlled by the first switch of SW1, and FCCM option can be selected by the second switch of SW1. Toggle the switch to the ON position (marked by a solid square) to enable switching or to select FCCM. The absolute maximum voltage of the external signal applied to EN (TP4) and FCCM (TP3) is +8V.

Table 1. Connections

Connection	Signal Name
VIN (TP2)	VIN
PGND (TP5)	Ground for VIN
VCC (TP16)	VCC Input
PGND (TP17)	Ground for VCC Input
VOUT (TP7)	V _{OUT} (+1.05V)
PGND (TP10)	Ground for V _{OUT}
EN (TP4)	Enable Input
FCCM (TP3)	Forced Continuous Conduction Mode Input

LAYOUT

The PCB is a 4-layer board. All layers are 1 oz. copper. IR3477 and other components are mounted on the top and bottom layers of the board.

The power supply decoupling capacitors, bootstrap capacitor and feedback components are located close to IR3477. To improve efficiency, the circuit board is designed to minimize the length of the on-board power ground current path.

CONNECTION DIAGRAM

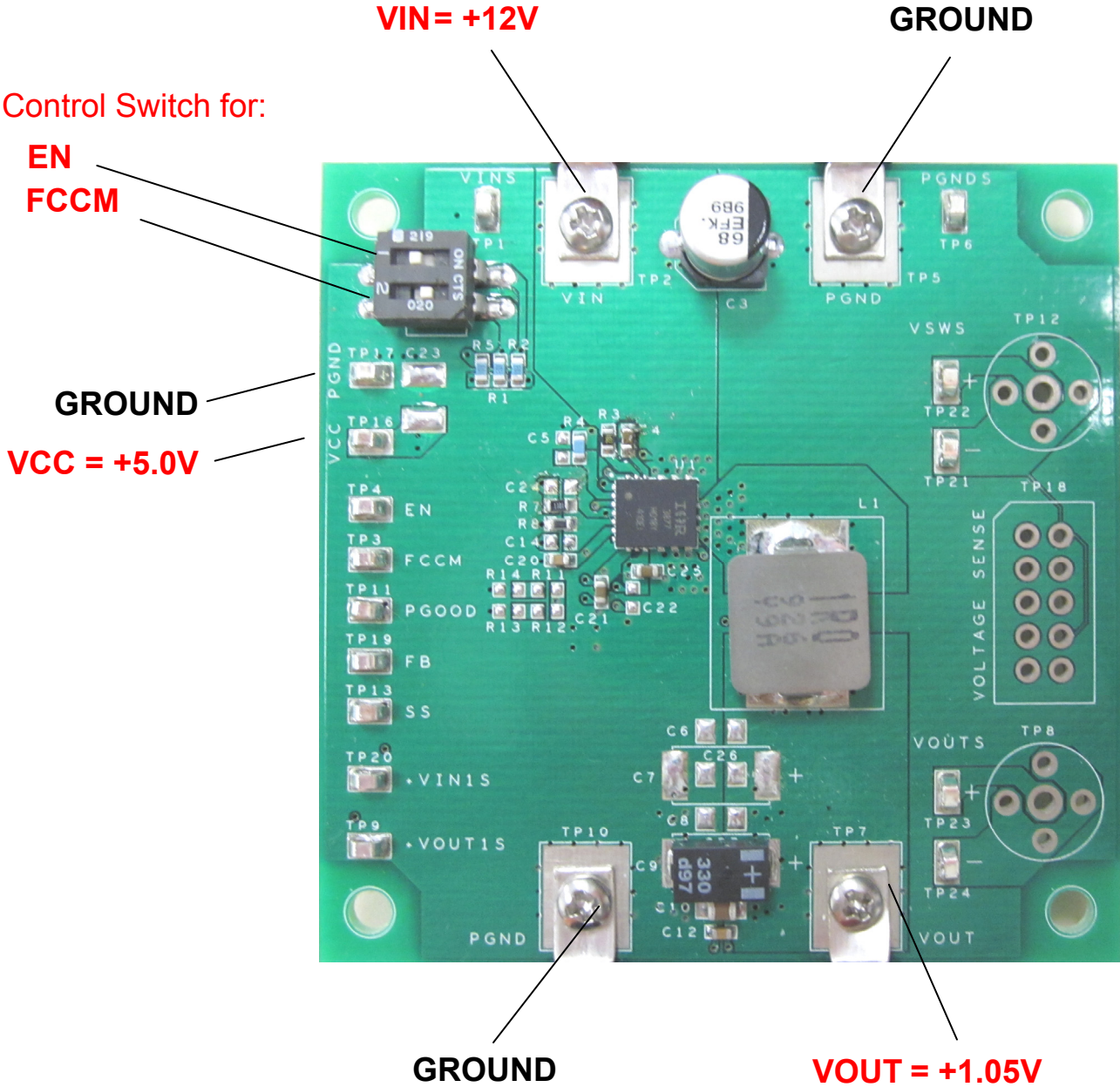

Fig. 1: Connection Diagram of IRDC3477 Evaluation Board

PCB Board Layout

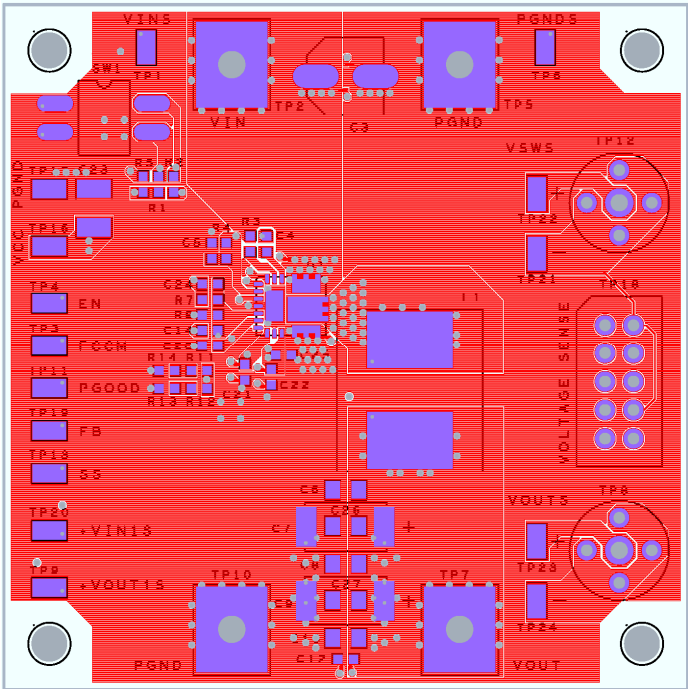

Fig. 4: Board Layout, Top Layer

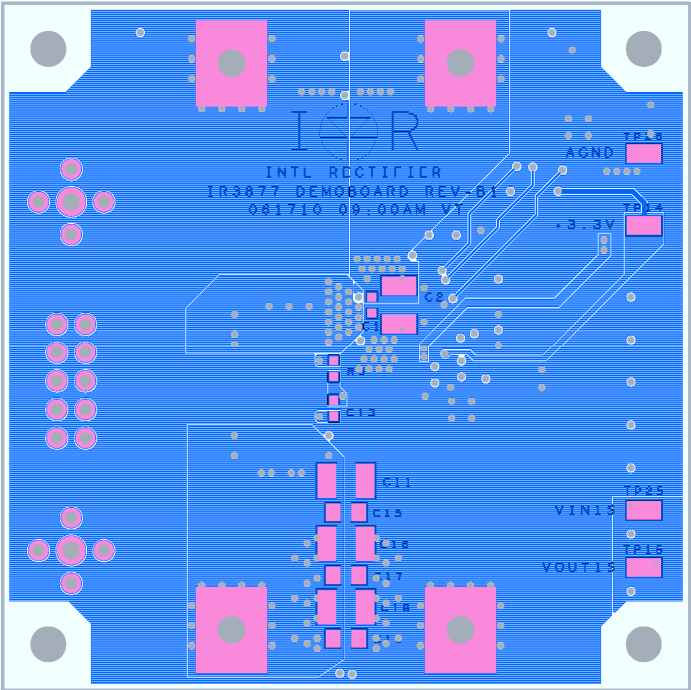

Fig. 5: Board Layout, Bottom Layer

PCB Board Layout

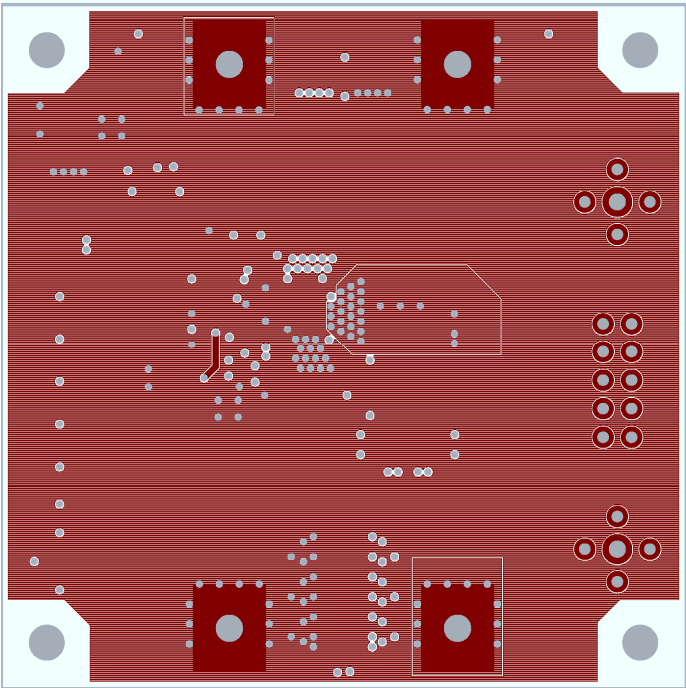

Fig. 6: Board Layout, Mid-layer I

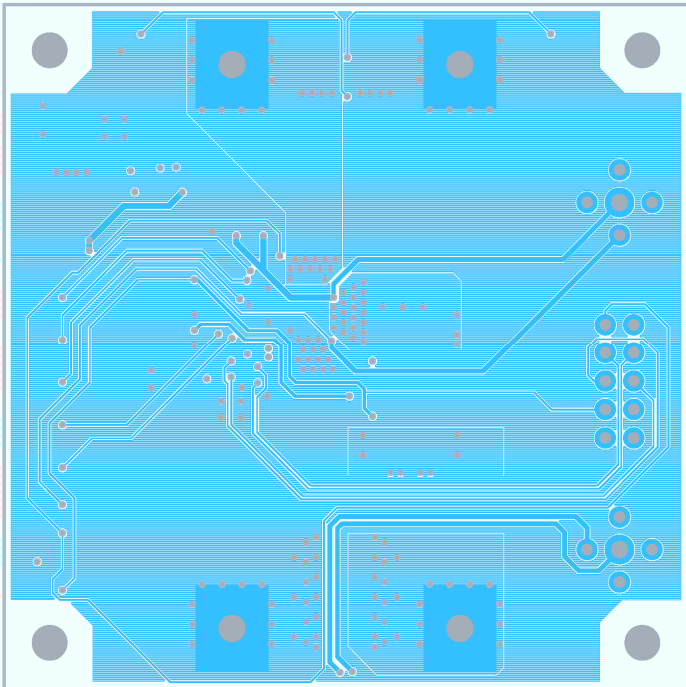

Fig. 7: Board Layout, Mid-layer II

Bill of Materials

QTY	REF DESIGNATOR	VALUE	DESCRIPTION	MANUFACTURER	PART NUMBER
4	C1, C21, C25, C4	1.00uF	capacitor, X7R, 1.00uF, 25V, 0.1, 0603	Murata	GRM188R71E105KA12D
1	C10	47uF	capacitor, 47uF, 6.3V, 805	Tdk	C2012X5R0J476M
29	C11, C13, C14, C15, C16, C17, C18, C19, C22, C23, C24, C26, C27, C5, C6, C7, C8, R11, R12, R13, R14, R6, TP10, TP12, TP18, TP2, TP5, TP7, TP8	-	Not Installed	-	-
2	C12, C20	0.100uF	capacitor, X7R, 0.100uF, 50V, 0.1, 603	TDK	C1608X7R1H104K
1	C2	22.0uF	capacitor, X5R, 22.0uF, 16V, 20%, 1206	Taiyo Yuden	EMK316BJ226ML-T
1	C3	68uF	capacitor, electrolytic, 68uF, 25V, 0.2, SMD	Panasonic	EEV-FK1E680P
1	C9	330uF	capacitor, 330uF, 2V, 20%, 7343	Panasonic	EEFSX0D331E4
1	L1	1.0uH	inductor, ferrite, 1.0uH, 20A, +/-20%, SMT	Cyntec	PIMB103E-1R0MS-39
3	R1, R2, R5	10.0K	resistor, thick film, 10.0K, 1/10W, 0.01, 0603	KOA	RK73H1J1002F
1	R3	200K	resistor, thick film, 200K, 1/10W, 0.01, 603	KOA	RK73H1JLTD2003F
1	R4	7.50K	resistor, thick film, 7.50K, 1/10W, 0.01, 603	KOA	RK73H1JLTD7501F
1	R7	1.33K	resistor, thick film, 1.33K, 1/10W, 0.01, 603	KOA	RK73H1J1331F
1	R8	1.21K	resistor, thick film, 1.21K, 1/10W, 0.01, 603	KOA	RK73H1JLTD1211F
1	SW1	SPST	switch, DIP, SPST, 2 position, SMT	C&K Components	SD02H0SK
19	TP1, TP11, TP13, TP14, TP15, TP16, TP17, TP19, TP20, TP21, TP22, TP23, TP24, TP25, TP26, TP3, TP4, TP6, TP9	60 mils	hardware, test point, 60 mils, 40 x 105 mils, 5015	Keystone	5015
1	U1	IR3477	5mm X 6mm QFN	IRF	IR3477

TYPICAL OPERATING WAVEFORMS

Tested with demoboard shown in Fig. 8, $V_{IN} = 12V$, $V_{CC} = 5V$, $V_{OUT} = 1.05V$, $F_s = 300kHz$, $T_A = 25^\circ C$, no airflow, unless otherwise specified

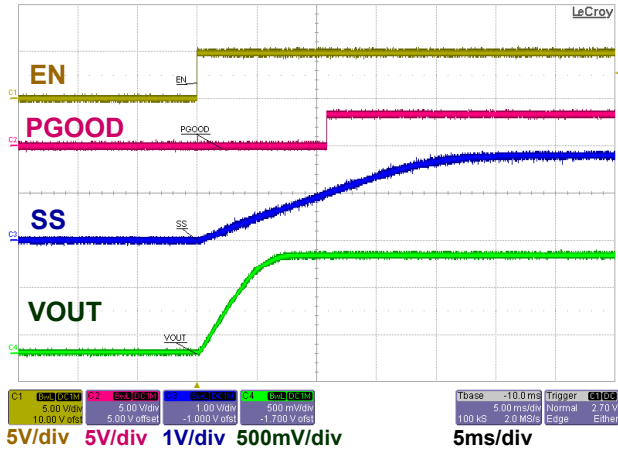

Fig. 9: Startup

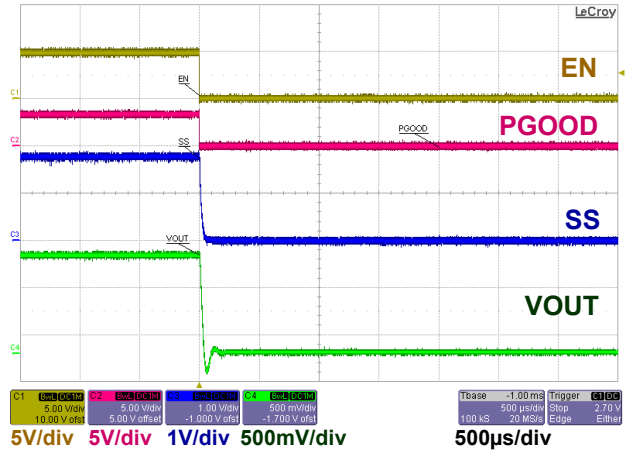

Fig. 10: Shutdown

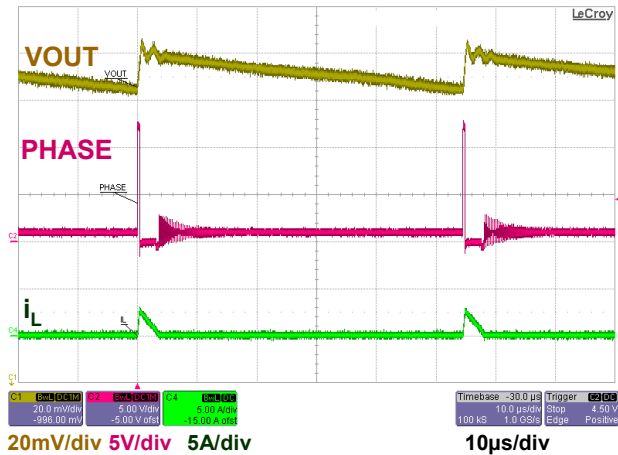

Fig. 11: DCM ($I_{OUT} = 0.1A$)

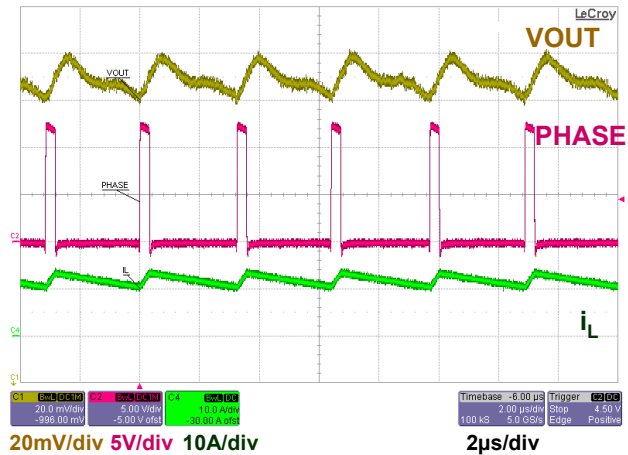

Fig. 12: CCM ($I_{OUT} = 12A$)

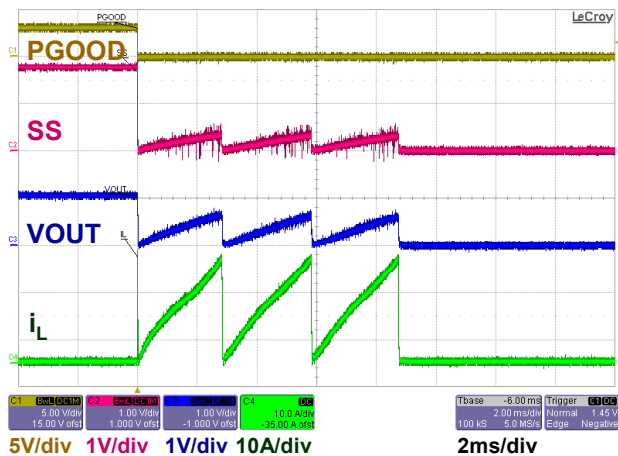

Fig. 13: Over Current Protection (tested by shorting VOUT to PGND on demoboard)

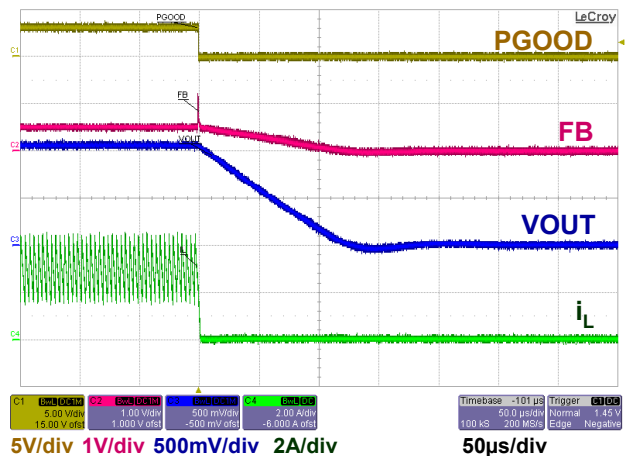

Fig. 14: Over Voltage Protection (tested by shorting FB to VOUT)

TYPICAL OPERATING WAVEFORMS

Tested with demoboard shown in Fig. 8, $V_{IN} = 12V$, $V_{CC} = 5V$, $V_{OUT} = 1.05V$, $F_s = 300kHz$, $T_A = 25^\circ C$, no airflow, unless otherwise specified

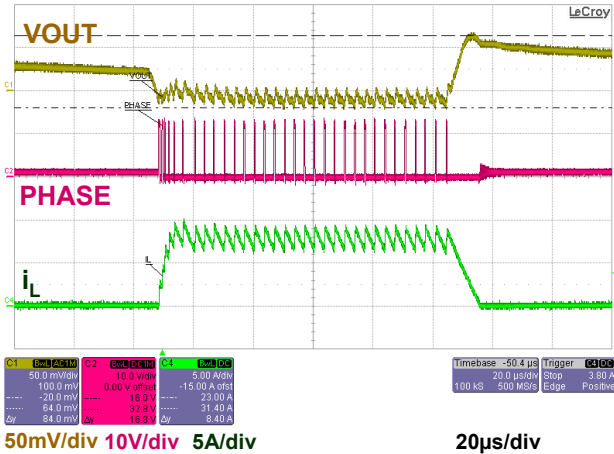

Fig. 15: Load Transient 0-8A

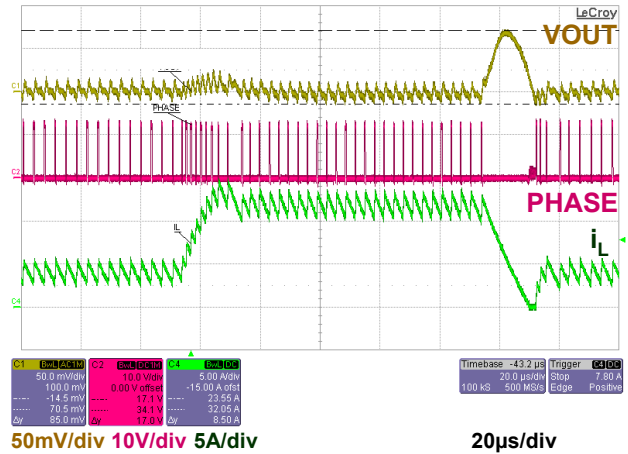

Fig. 16: Load Transient 4-12A

TYPICAL PERFORMANCE

$V_{IN} = 12V$, $V_{CC} = 5V$, $V_{OUT} = 1.05V$, $F_s = 300kHz$, $I_{OUT} = 15A$, $T_A = 25^\circ C$, no airflow

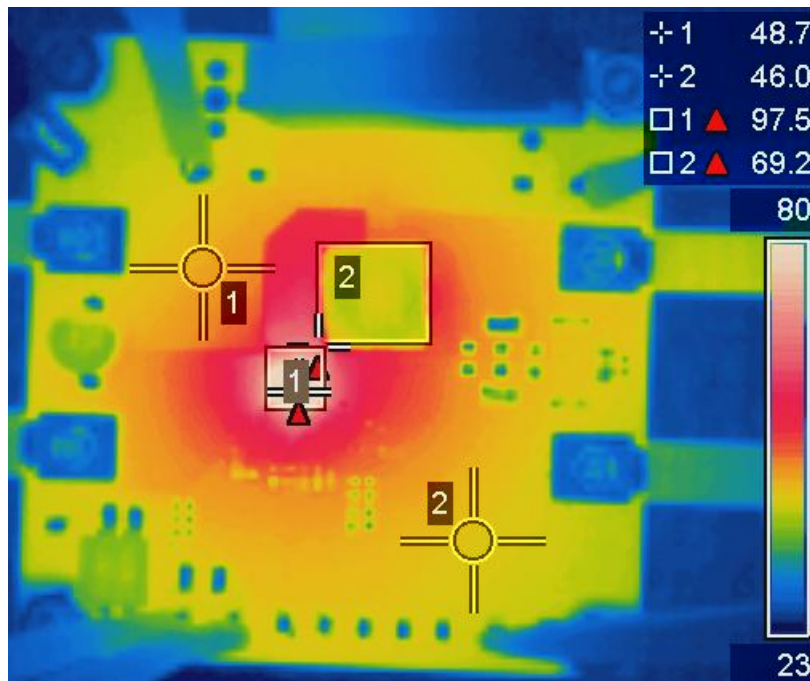

Fig. 17: Thermal Image (IR3477: 98°C, Inductor: 69°C, PCB: 49°C)

TYPICAL OPERATING DATA

VIN = 12V, VCC = 5V, VOUT = 1.05V, Fs = 300kHz, IOU = 0 ~ 15A, TA = 25°C, no airflow, unless otherwise specified

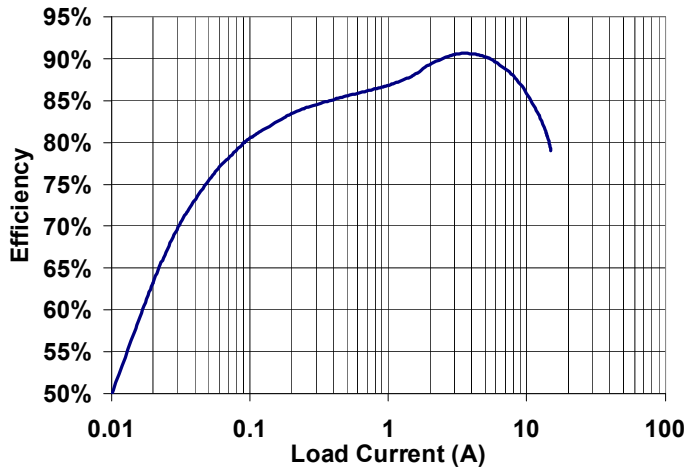

Fig. 18: Efficiency vs. Output Current

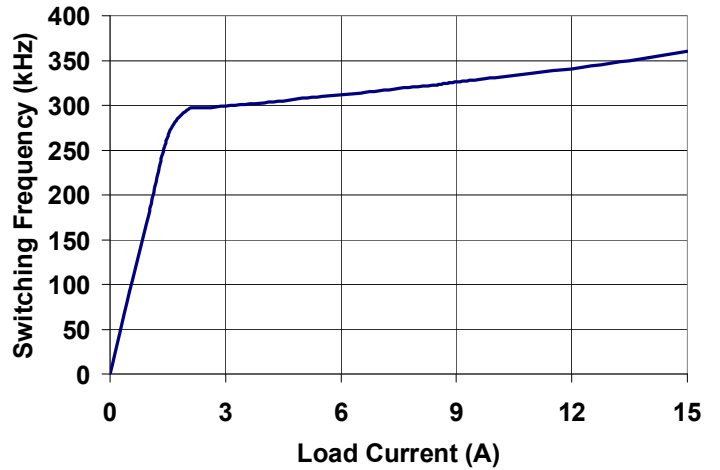

Fig. 19: Switching Frequency vs. Output Current

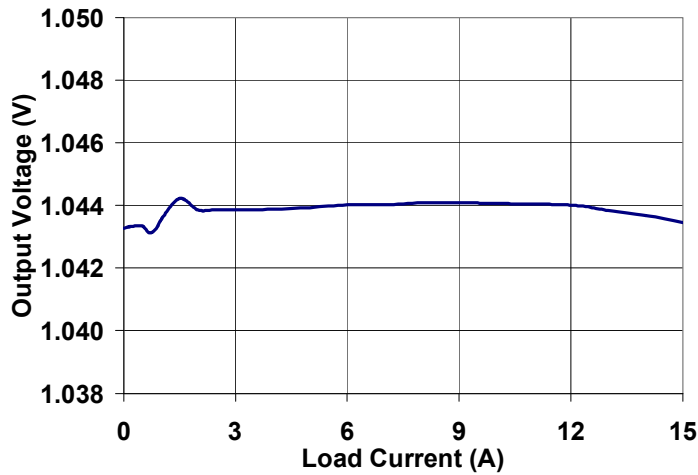

Fig. 20: Load Regulation

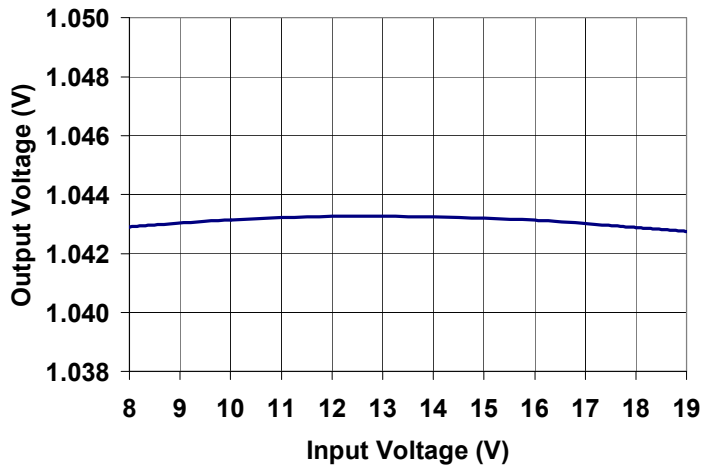

Fig. 21: Line Regulation at 15A Load

PCB Metal and Components Placement

Lead lands (the 13 IC pins) width should be equal to nominal part lead width. The minimum lead to lead spacing should be $\geq 0.2\text{mm}$ to minimize shorting.

Lead land length should be equal to maximum part lead length + 0.3 mm outboard extension. The outboard extension ensures a large toe fillet that can be easily inspected.

Pad lands (the 4 big pads) length and width should be equal to maximum part pad length and width. However, the minimum metal to metal spacing should be no less than; 0.17mm for 2 oz. Copper or no less than 0.1mm for 1 oz. Copper or no less than 0.23mm for 3 oz. Copper.

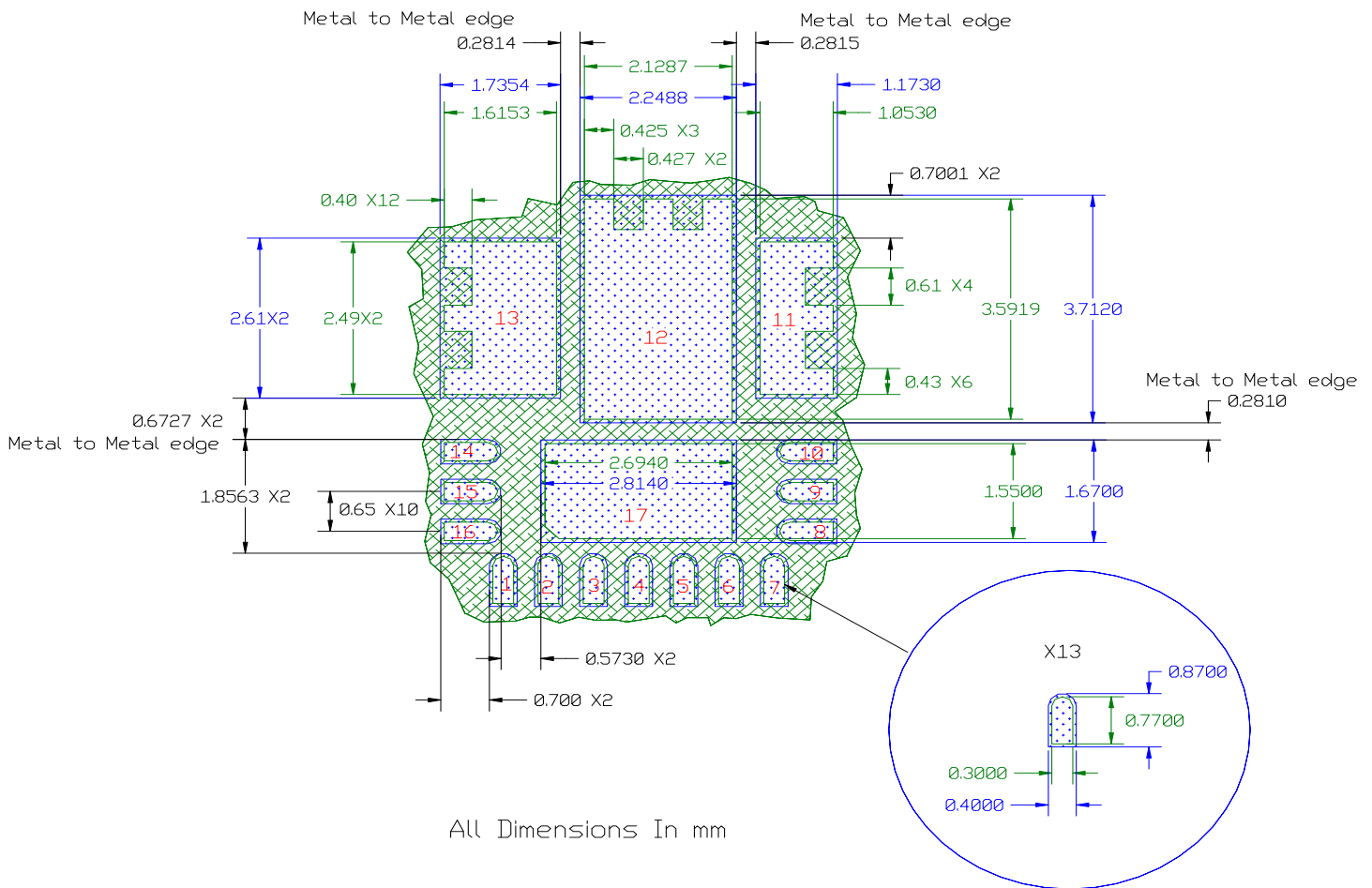

-  PCB Copper
-  PCB Solder Resist

Solder Resist

It is recommended that the lead lands are Non Solder Mask Defined (NSMD). The solder resist should be pulled away from the metal lead lands by a minimum of 0.025mm to ensure NSMD pads.

The land pad should be Solder Mask Defined (SMD), with a minimum overlap of the solder resist onto the copper of 0.05mm to accommodate solder resist misalignment.

Ensure that the solder resist in between the lead lands and the pad land is $\geq 0.15\text{mm}$ due to the high aspect ratio of the solder resist strip separating the lead lands from the pad land.

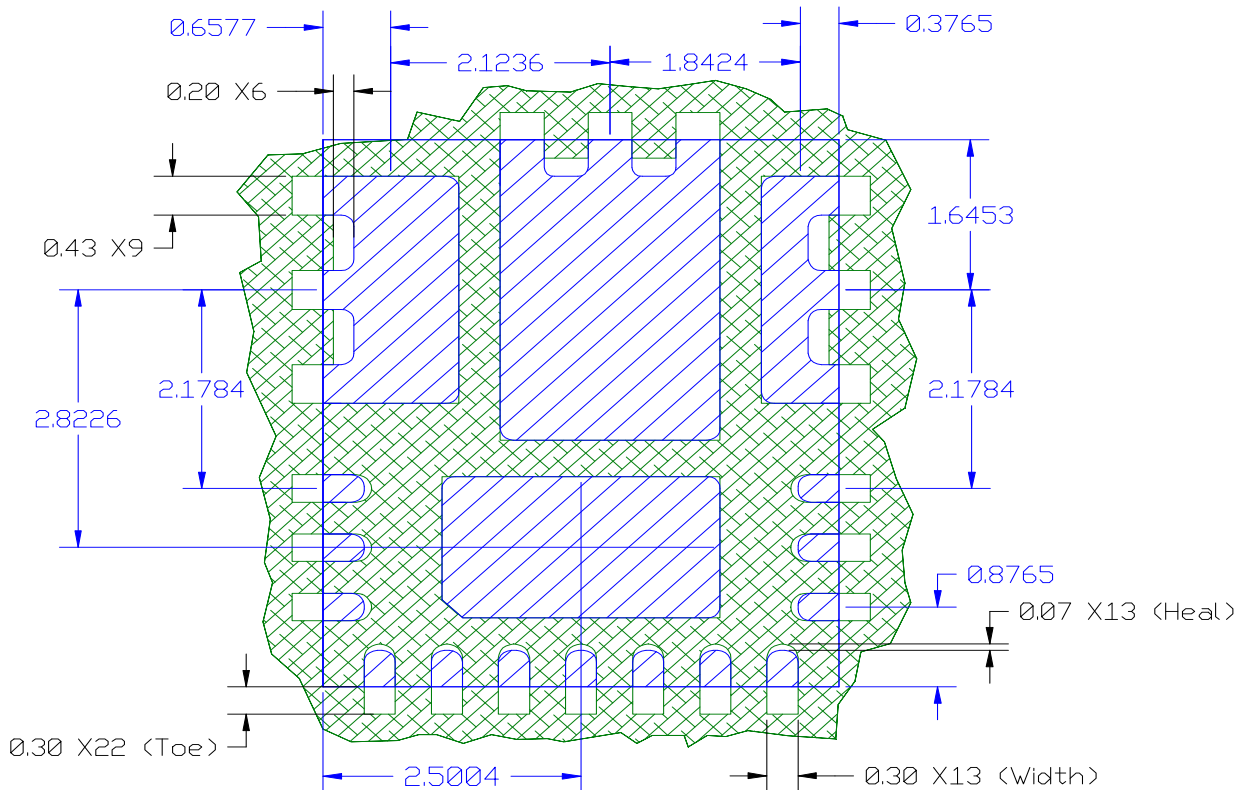

All Dimensions In mm
 All Pads are Solder Mask Defined
 Pad Center to Center dimensions



Stencil Design

The Stencil apertures for the lead lands should be approximately 80% of the area of the lead lads. Reducing the amount of solder deposited will minimize the occurrences of lead shorts. If too much solder is deposited on the center pad the part will float and the lead lands will open.

The maximum length and width of the land pad stencil aperture should be equal to the solder resist opening minus an annular 0.2mm pull back in order to decrease the risk of shorting the center land to the lead lands when the part is pushed into the solder paste.

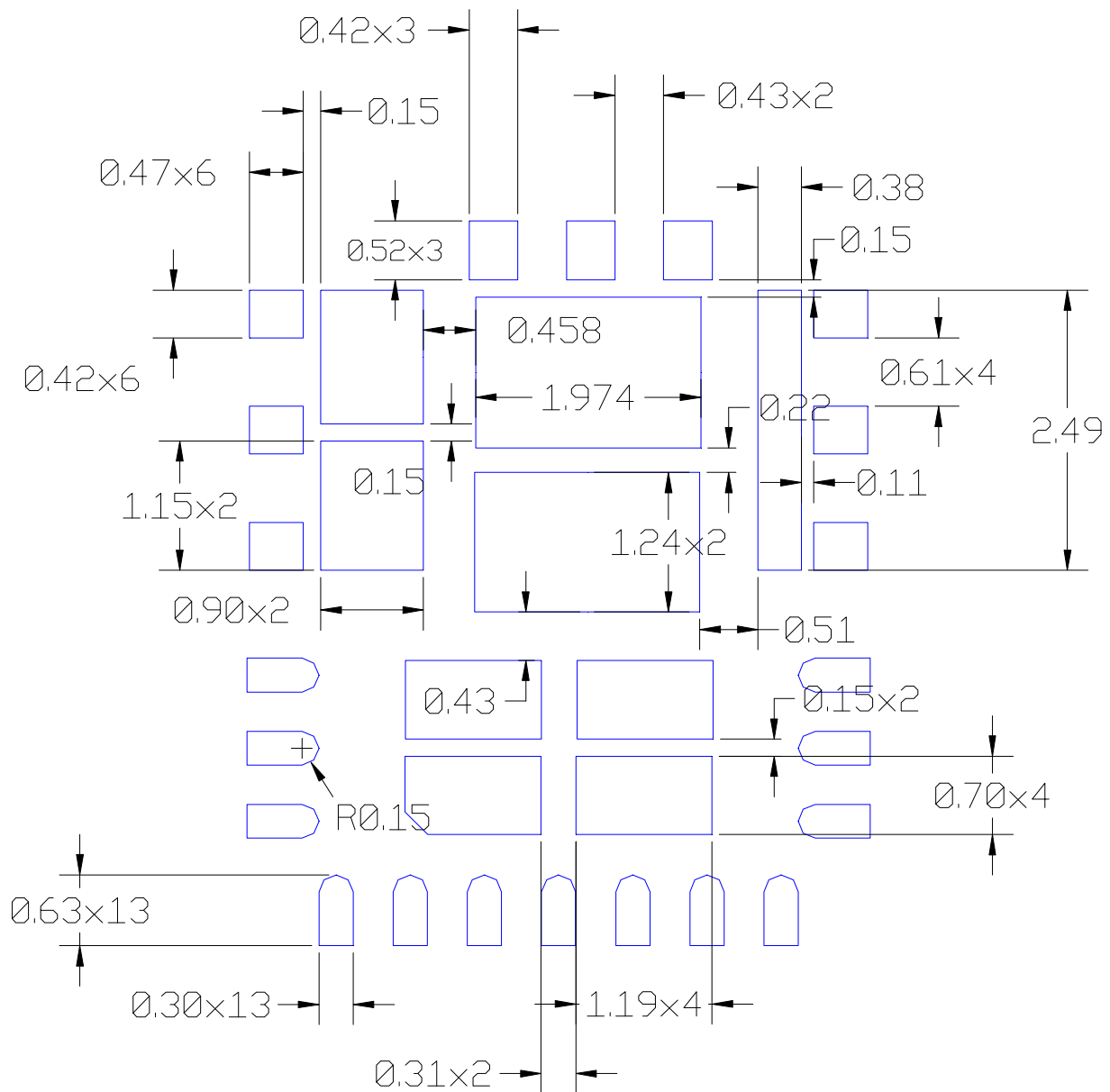

DIM	MILIMITERS		INCHES		DIM	MILIMITERS		INCHES	
	MIN	MAX	MIN	MAX		MIN	MAX	MIN	MAX
A	0.800	1.000	0.0315	0.0394	L	0.350	0.450	0.0138	0.0177
A1	0.000	0.050	0.0000	0.0020	M	2.441	2.541	0.0961	0.1000
b	0.375	0.475	0.1477	0.1871	N	0.703	0.803	0.0277	0.0316
b1	0.250	0.350	0.0098	0.1379	O	2.079	2.179	0.0819	0.0858
c	0.203 REF.		0.008 REF.		P	3.242	3.342	0.1276	0.1316
D	5.000 BASIC		1.969 BASIC		Q	1.265	1.365	0.0498	0.0537
E	6.000 BASIC		2.362 BASIC		R	2.644	2.744	0.1041	0.1080
e	1.033 BASIC		0.0407 BASIC		S	1.500	1.600	0.0591	0.0630
e1	0.650 BASIC		0.0256 BASIC		t1, t2, t3	0.401 BASIC		0.016 BACIS	
e2	0.852 BASIC		0.0335 BASIC		t4	1.153 BASIC		0.045 BASIC	
					t5	0.727 BASIC		0.0286 BASIC	

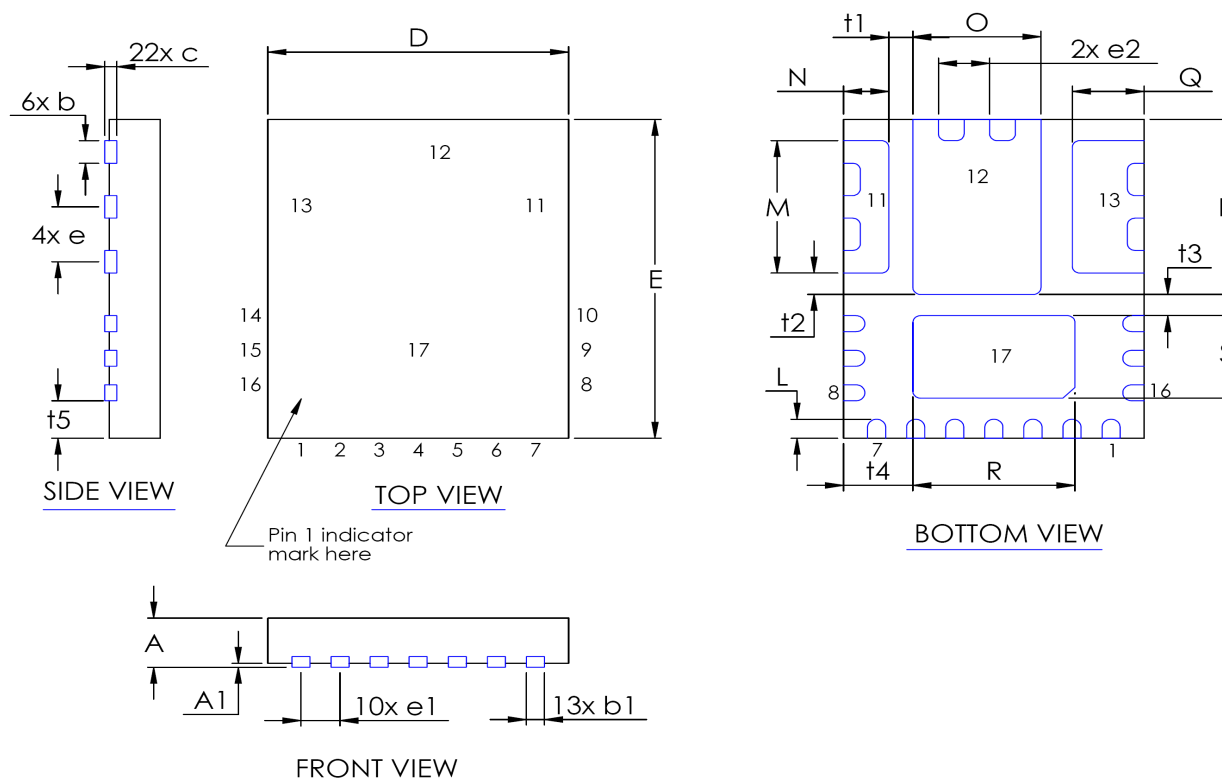

IR WORLD HEADQUARTERS: 233 Kansas St., El Segundo, California 90245, USA Tel: (310) 252-7105

TAC Fax: (310) 252-7903

Visit us at www.irf.com for sales contact information

Data and specifications subject to change without notice. 11/10