

DETAILS

Product Number	FP14825_STRADA-2X2MXS-DWC2
Family	Strada
Type	Pack
Color	clear
Diameter	90x90 mm
Height	14 mm
Style	square
Optic Material	Silicone
Holder Material	
Fastening	screw
Status	sample approved
ROHS Compliant	Yes
Date Updated	10/03/2017



OPTICAL PROPERTIES

LED	Viewing	Light	Effi-	cd/lm	Connector
	Angle	Beam	ciency		
PSL445	Asymmetric deg	Asymmetric	93 %	0.500	-
PSL440	Asymmetric deg	Asymmetric	94 %	0.630	-
XHP70	Asymmetric deg	Asymmetric	92 %	0.520	-
XHP35 HD	Asym deg	Asymmetric	92 %	0.660	-
XHP35 HI	Asymmetric deg	Asymmetric	92 %	0.640	-
XHP50	Asymmetric deg	Asymmetric	92 %	0.600	-
H70E0	Asymmetric deg	Asymmetric	92 %	0.570	-
LUXEON M/MX	Asymmetric deg	Asymmetric	94 %	0.640	-
LUXEON XR-M square 2x2	Asymmetric deg	Asymmetric	94 %	0.590	-
LUXEON MZ	Asymmetric deg	Asymmetric	75 %	0.610	-
NV4x144A	Asymmetric deg	Asymmetric	93 %	0.580	-
NFMW48xA	sim: asym	Asymmetric	sim: 93 %	sim: 0.630	-
Duris S10	Asymmetric deg	Asymmetric	94 %	0.600	-

H G F E D C B A

4

3

2

1

4

3

2

1

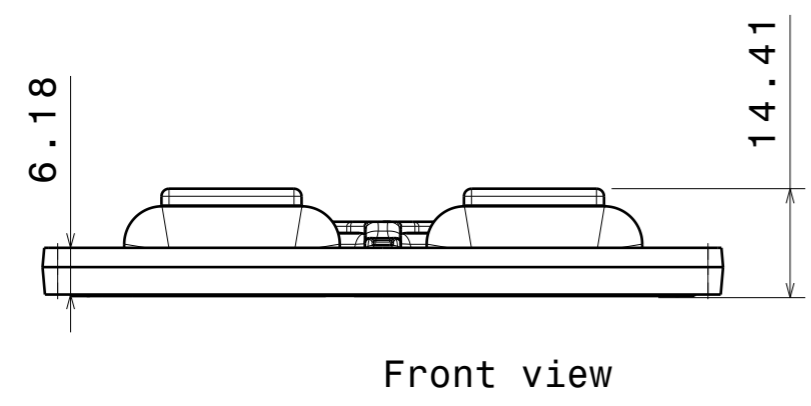
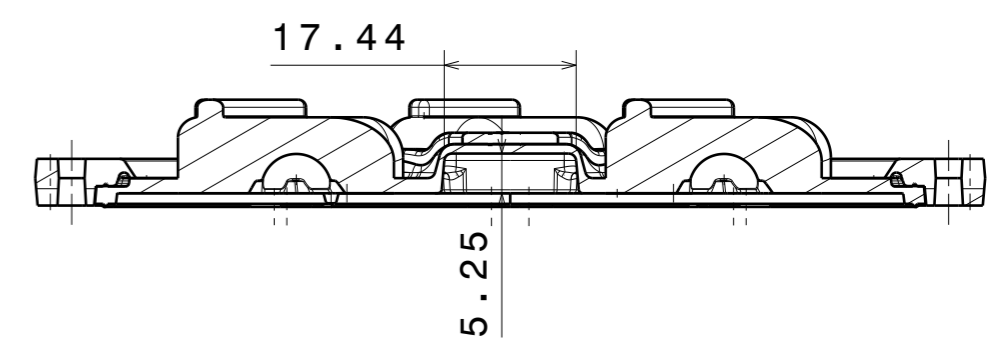
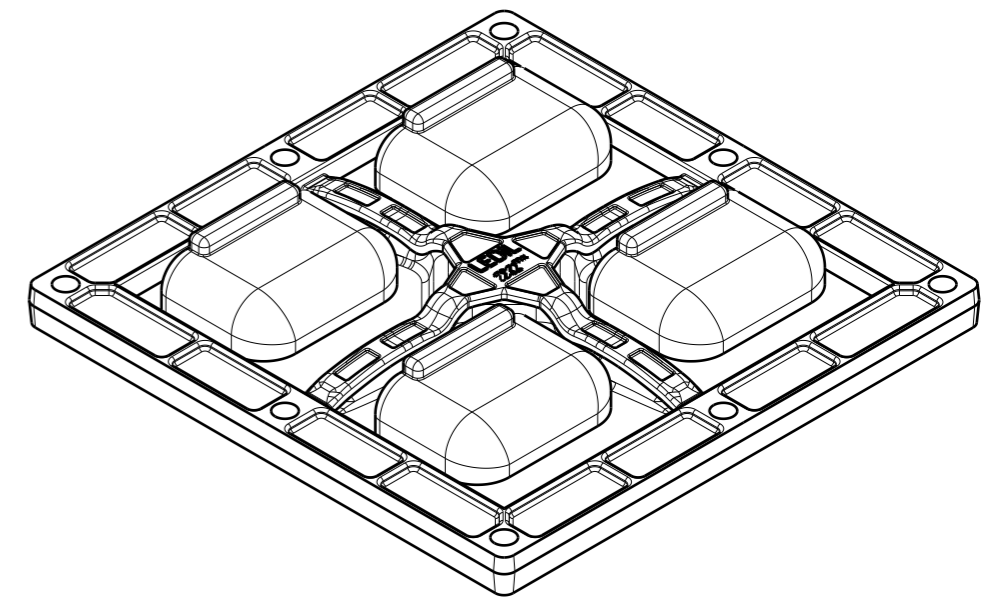
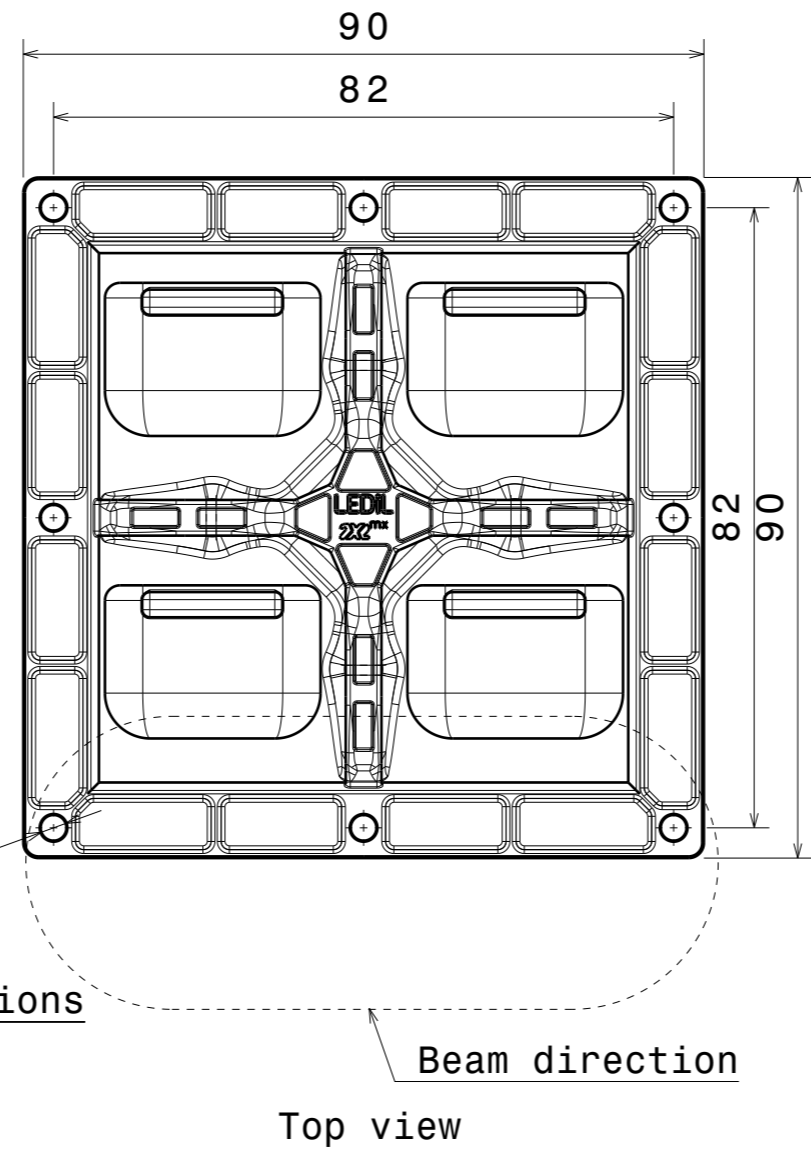
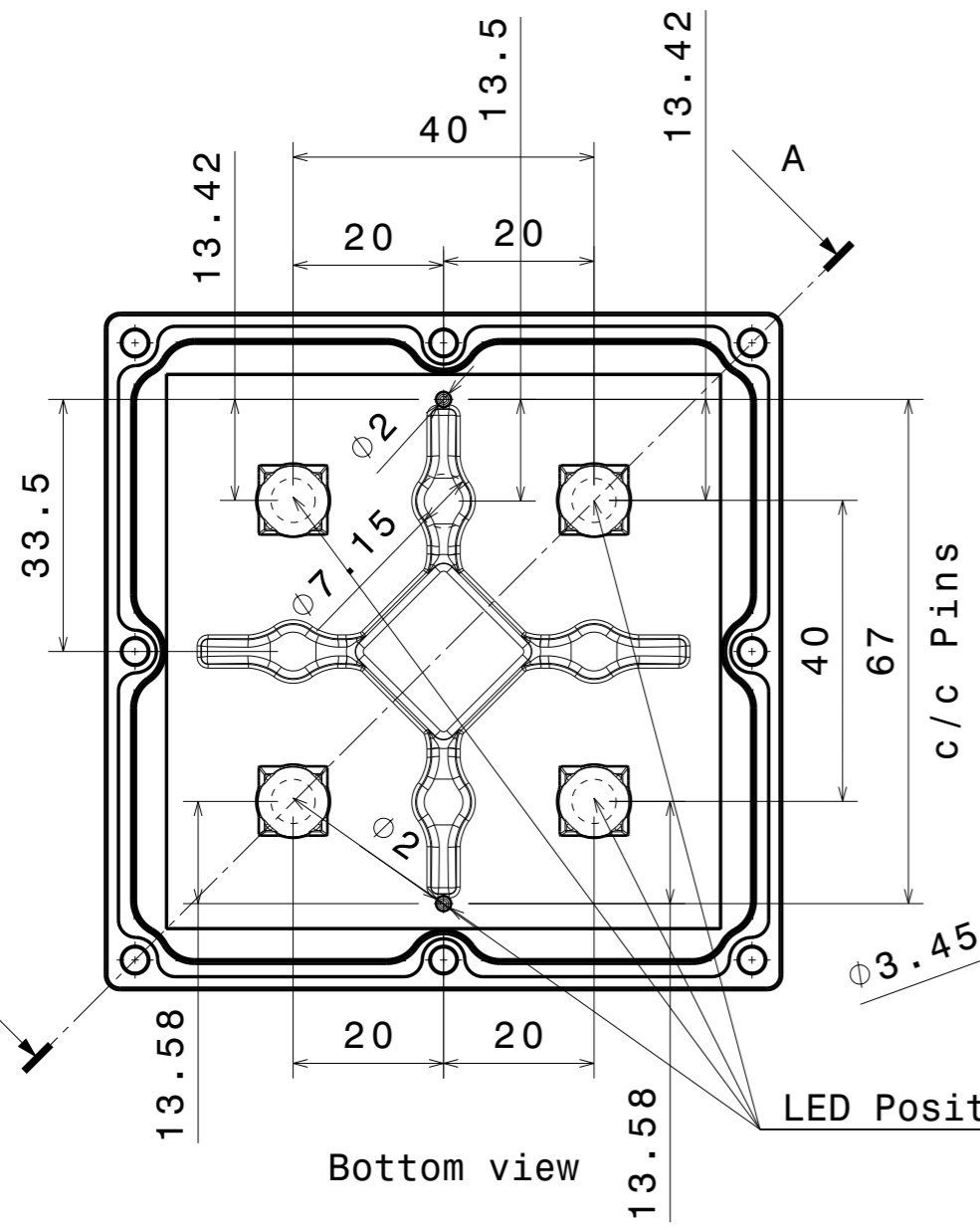

INDEX	PART NO	DESCRIPTION	MATERIAL	COLOUR
1	F14812	STRADA-2X2MXS-DWC2	Silicone	Clear
2	F14813	STRADA-2X2MXS-FRAME	PA-GF	black

Tolerances if not otherwise shown
According to DIN ISO 2768-1
Linear measures:
Up to 30mm class M, otherwise class C
According to DIN ISO 2768-2
Form and position: class L

THIRD ANGLE PROJECTION:

This drawing is the property of LEDiL Oy. It may not be reproduced, copied or communicated without a written agreement with LEDiL Oy.

LEDiL Ledil Oy
Salorankatu 10
FIN 24240 SALO
Finland

DRAWING TITLE
Mechanical Drawing

SIZE	PART NUMBER
A3	FN14825

SCALE	1:1	WEIGHT	-	SHEET	1/1
-------	-----	--------	---	-------	-----

H G B A

Luminaire: LEDiL Oy FN14825_STRADA-2X2MXS-DWC2_(PSL445)
Lamps: 1 x Citizen_PSL445_2x2_1674.9lm@250mA_P=11.1421W_I=0.250A_CCT=2700K

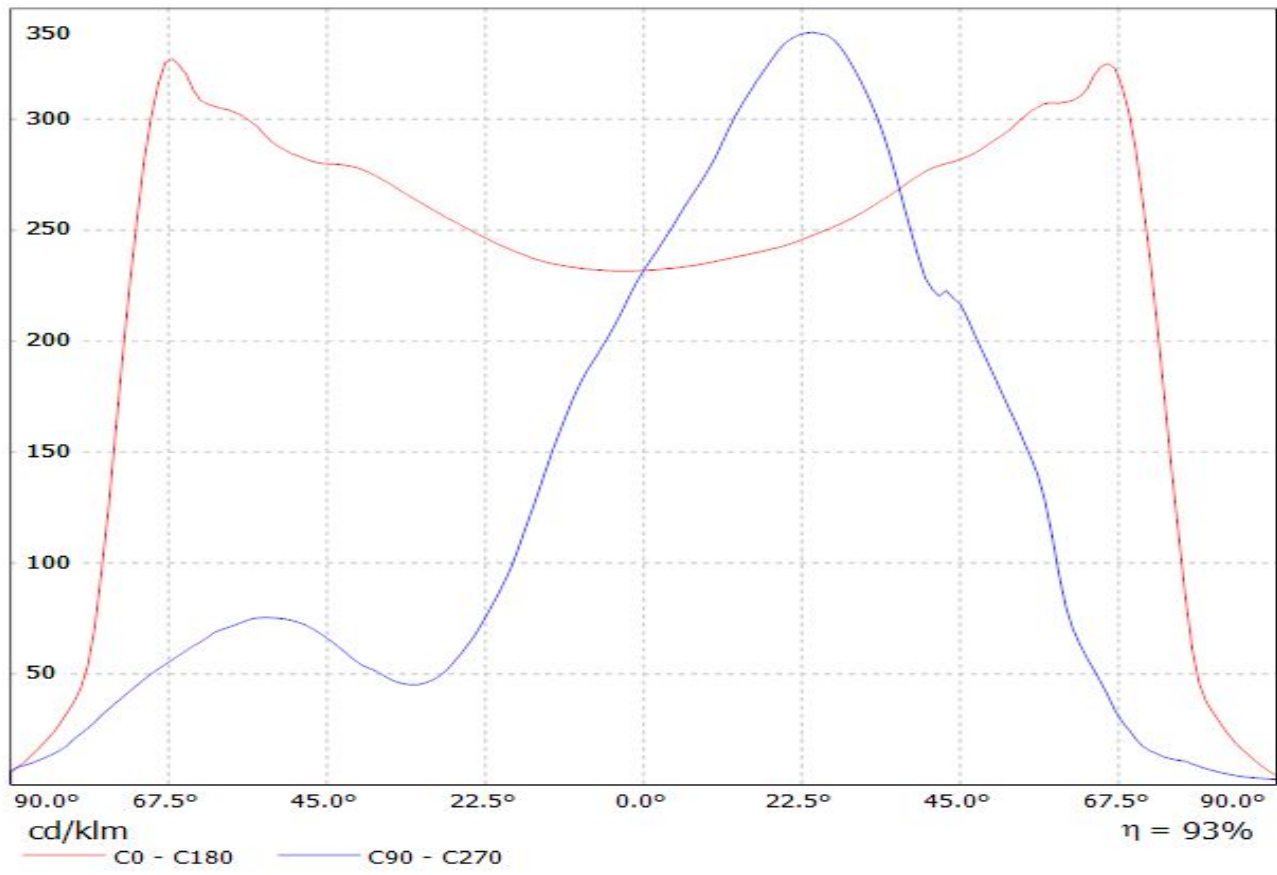

Luminaire: Ledil FN14825_STRADA-2X2MXS-DWC2_(PSL440)

Lamps: 1 x Citizen_PSL440_1078.26lm@250mA_CCT=2700K_P=11.4122W_I=0.25A

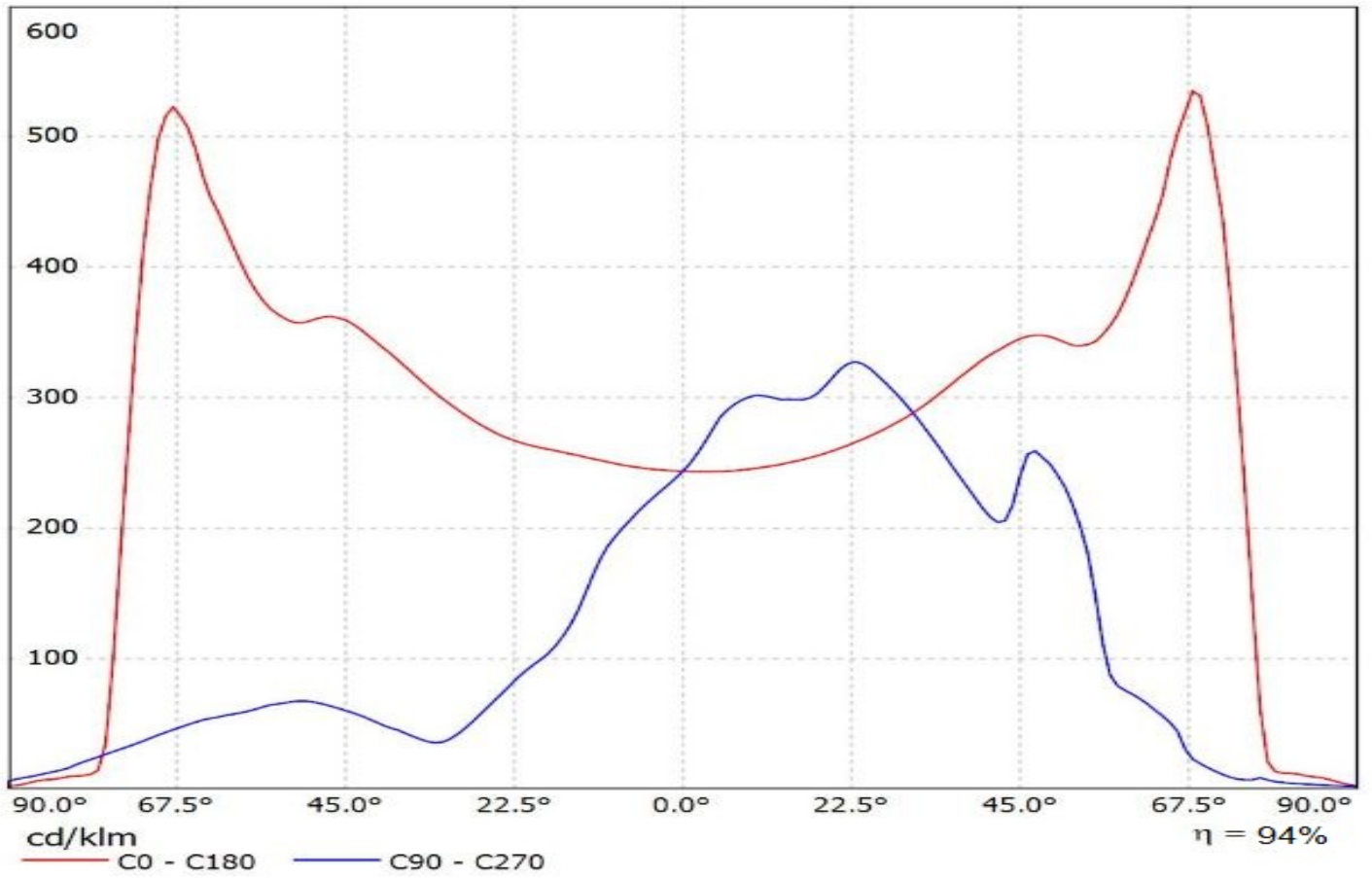

Luminaire: LEDiL Oy FN14825_STRADA-2X2MXS-DWC2_(XHP70)
Lamps: 1 x Cree_XHP70-2X2MX_1465.47lm@250mA_P=10.968W_I=0.250A

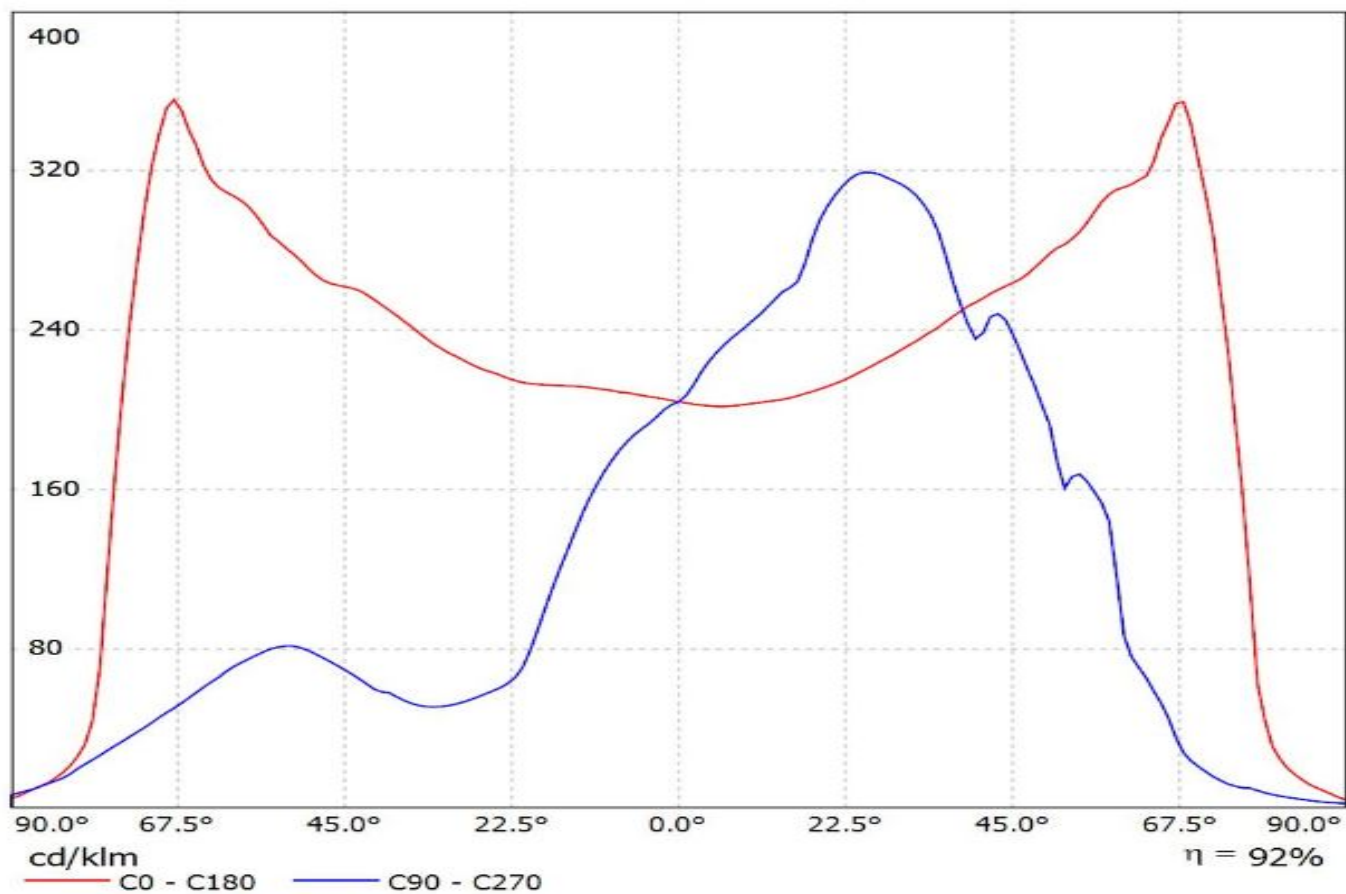

Luminaire: LEDiL Oy FN14825_STRADA-2X2MXS-DWC2_(XHP35_HD)

Lamps: 1 x Cree_XHP35_HD_(XHP35A-0-2D0-D40-D0-B-01)_1724.66lm@250mA_P=11.3017W_I=0.250A

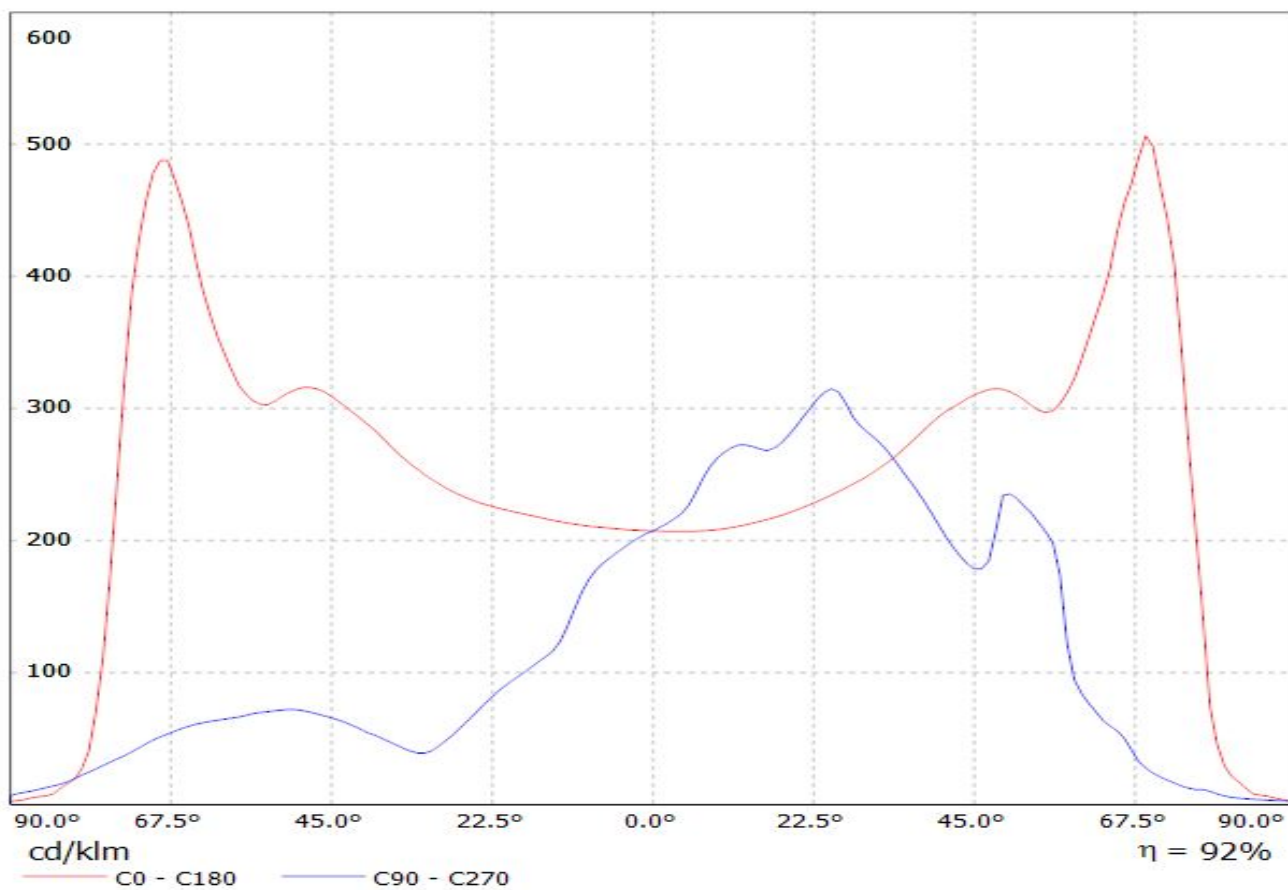

Luminaire: LEDiL Oy FN14825_STRADA-2X2MXS-DWC2_(XHP35_HI)
Lamps: 1 x Cree_XHP35_HI_(XHP35A-H-5C0-D40-D0-B-01)_1615.75lm@250mA_CCT=4000K_P=11.4373W_I=0.250A

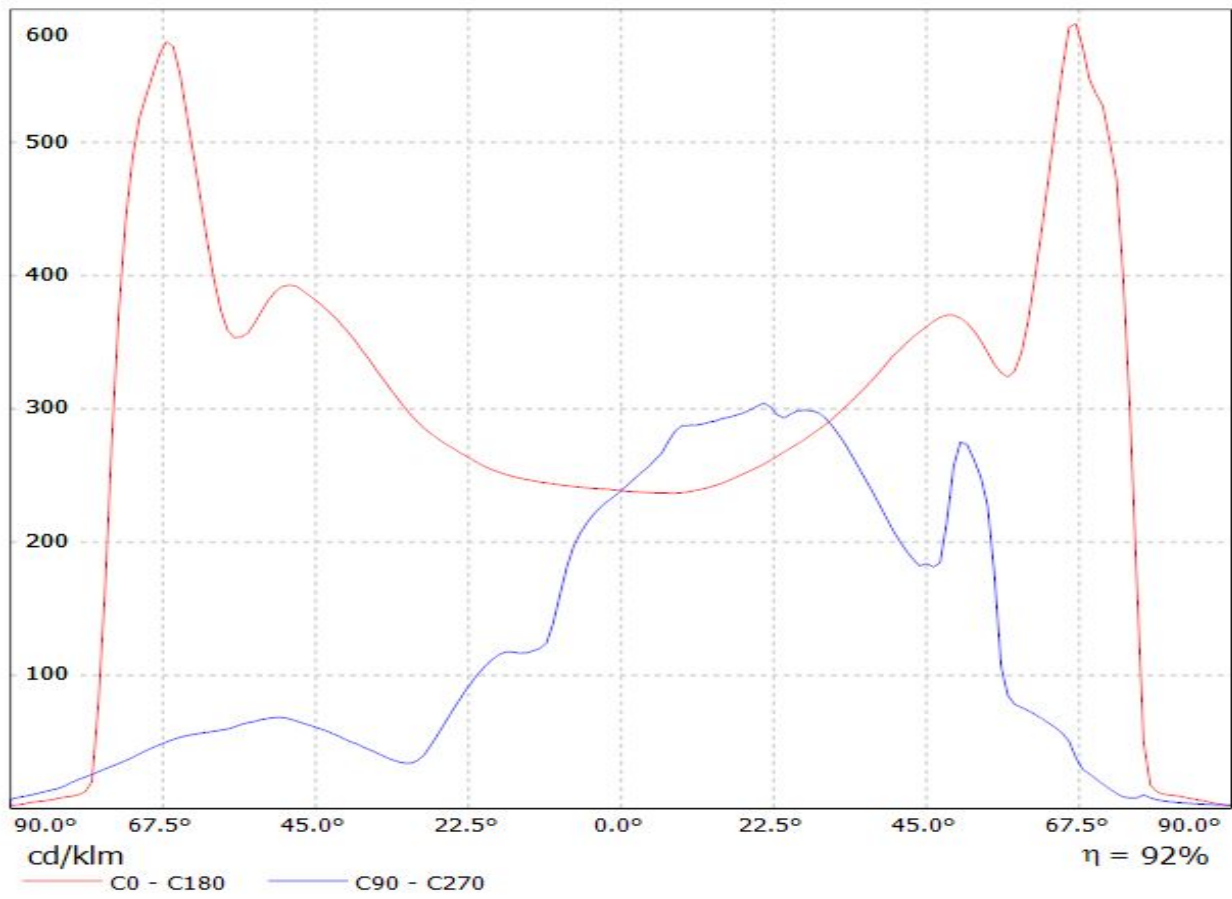

Luminaire: LEDiL Oy FN14825_STRADA-2X2MXS-DWC2_(XHP50)

Lamps: 1 x Cree_XHP50_(XHP50-0-1B0-J20-D0-B-01)_1815.51lm@250mA_P=11.4658W_I=0.250A

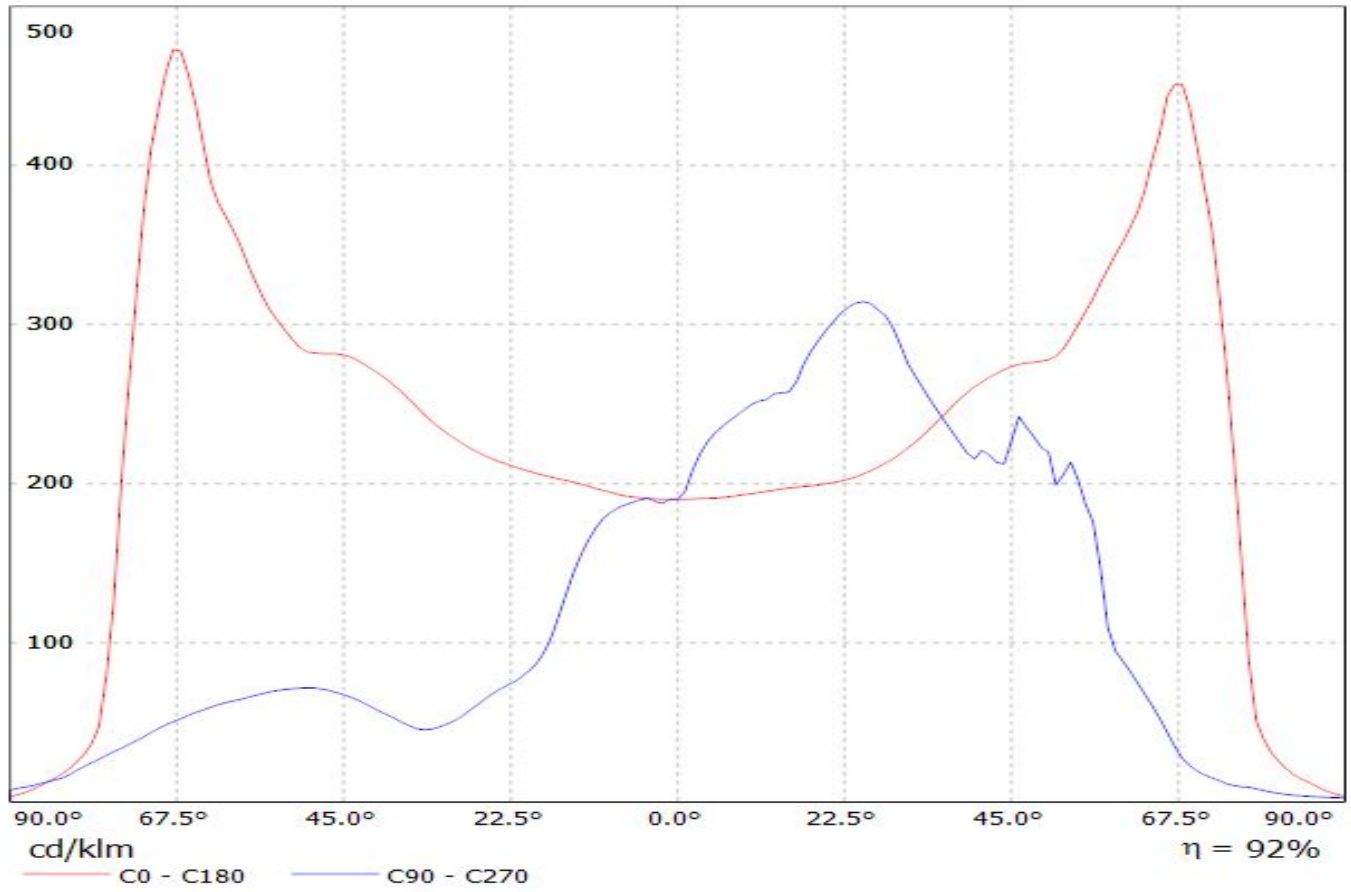

Luminaire: LEDiL Oy FN14825_STRADA-2X2MXS-DWC2_(H70E0)
Lamps: 1 x LG_H70E0_1790.78lm@250mA_P=11.2987W_I=0.250A

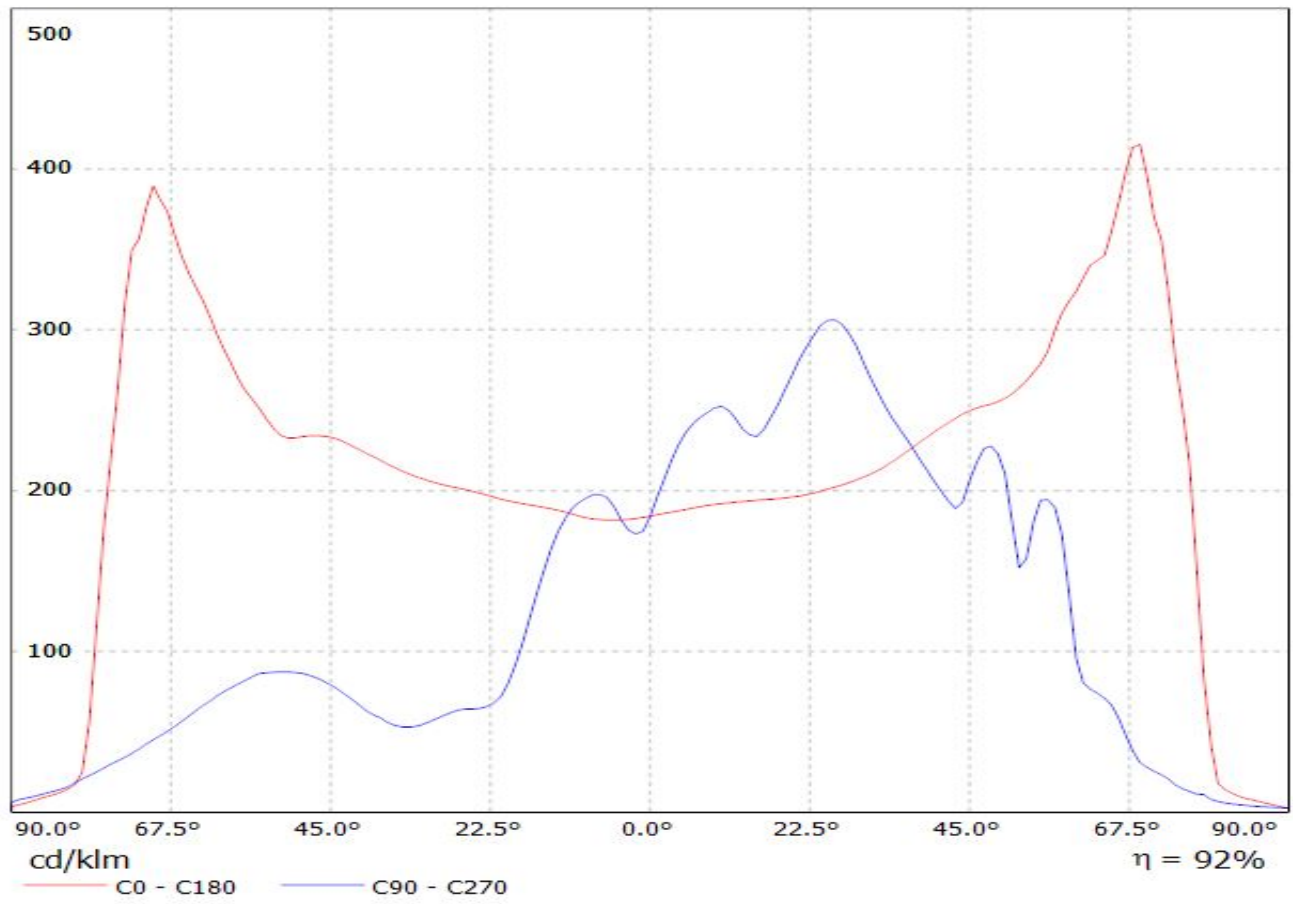

Luminaire: LEDiL Oy FN14825_STRADA-2X2MXS-DWC2_(Luxeon_M)
Lamps: 1 x Luxeon_M_1742.28lm@250mA_P=10.8298W_I=0.250A

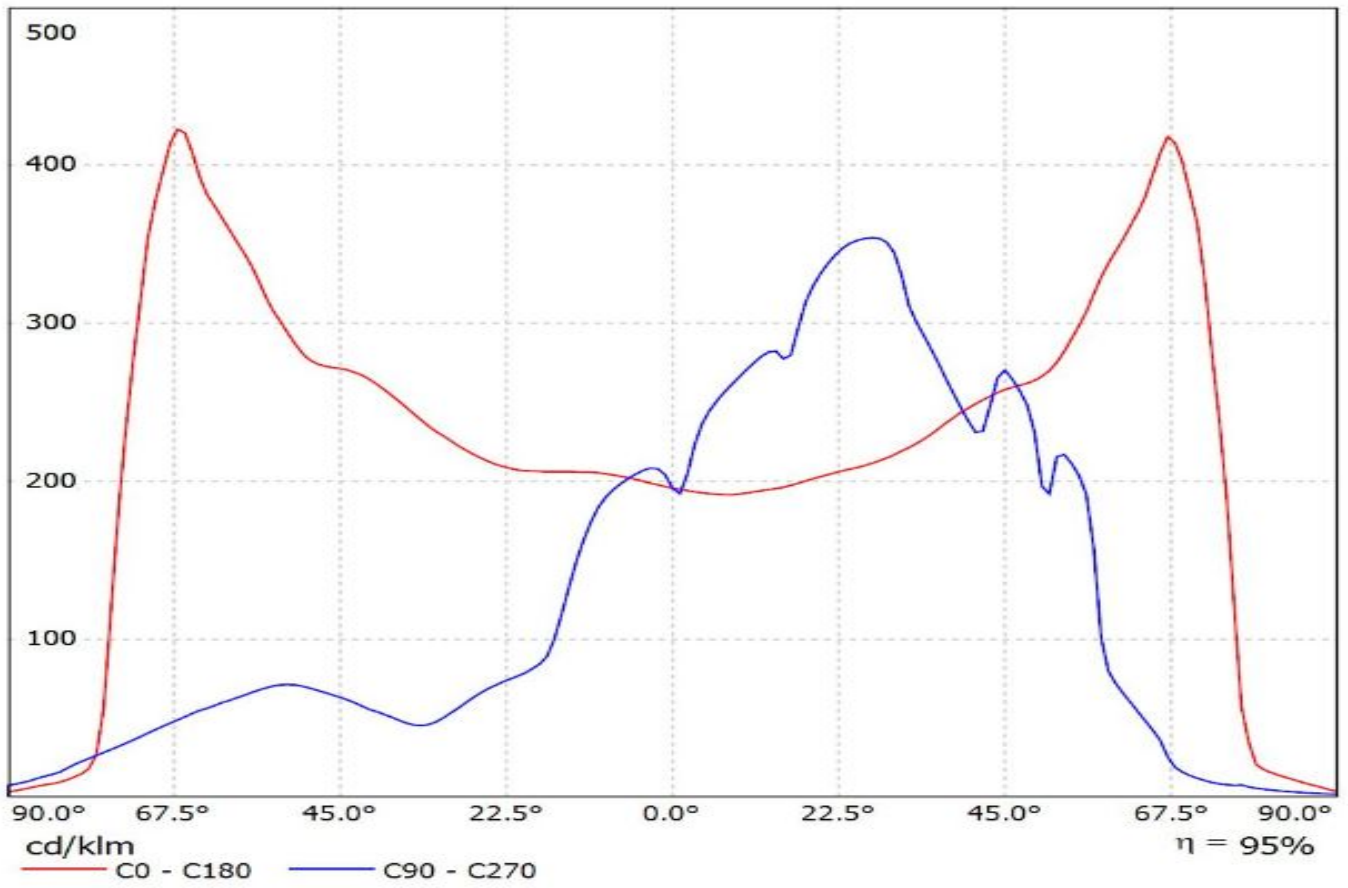

Luminaire: Ledil FN14825_STRADA-2X2MXS-DWC2_(XR-M)

Lamps: 1 x Luxeon_XR-M_2x2_(L2M0-577004MC2200)_1806.51lm@250mA_P=10.9462W_η=0.25A

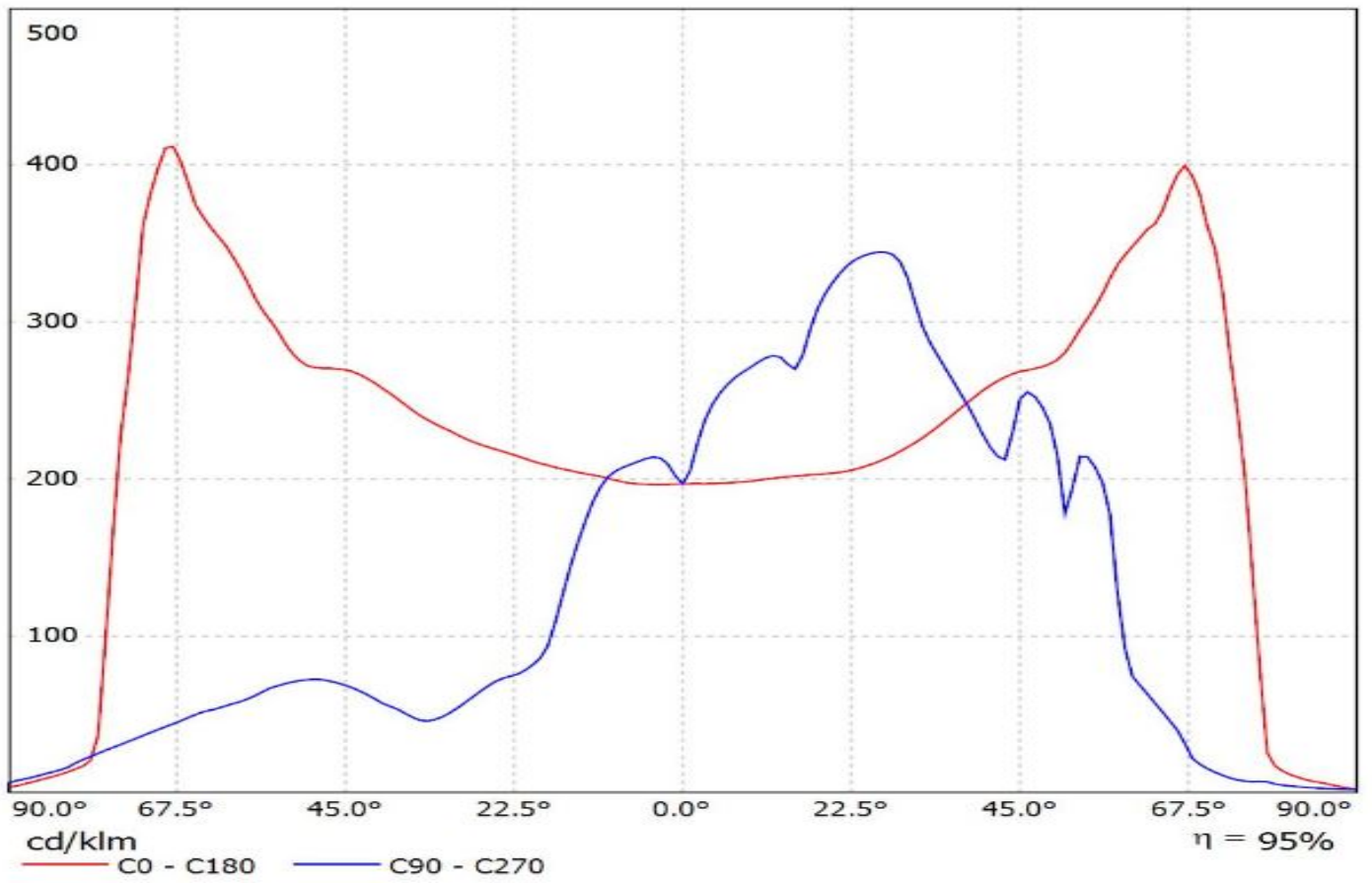

Luminaire: Ledil FN14825_STRADA-2X2MXS-DWC2_(LUXEON_MZ)

Lamps: 1 x LUXEON_MZ_2X2_(LMZ9-SW30)_1377.64lm@250mA_CCT=3000K_P=11.05W_I=0.25A

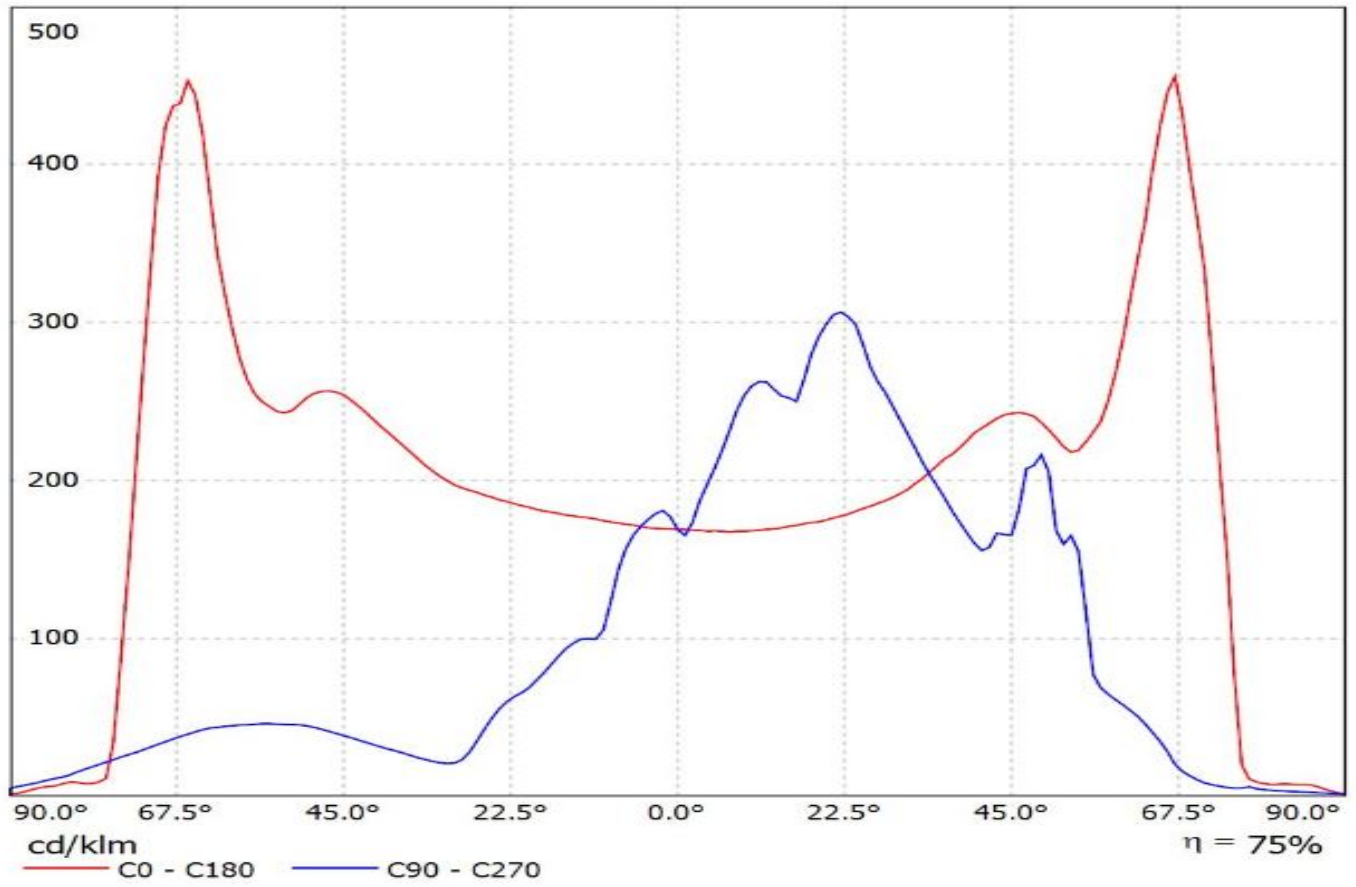

Luminaire: LEDiL Oy FN14825_STRADA-2X2MXS-DWC2_(NV4x144A)
Lamps: 1 x Nichia_NV4x144A_(NV4W144AR)_1847lm@250mA_P=11.0074W_I=0.250A

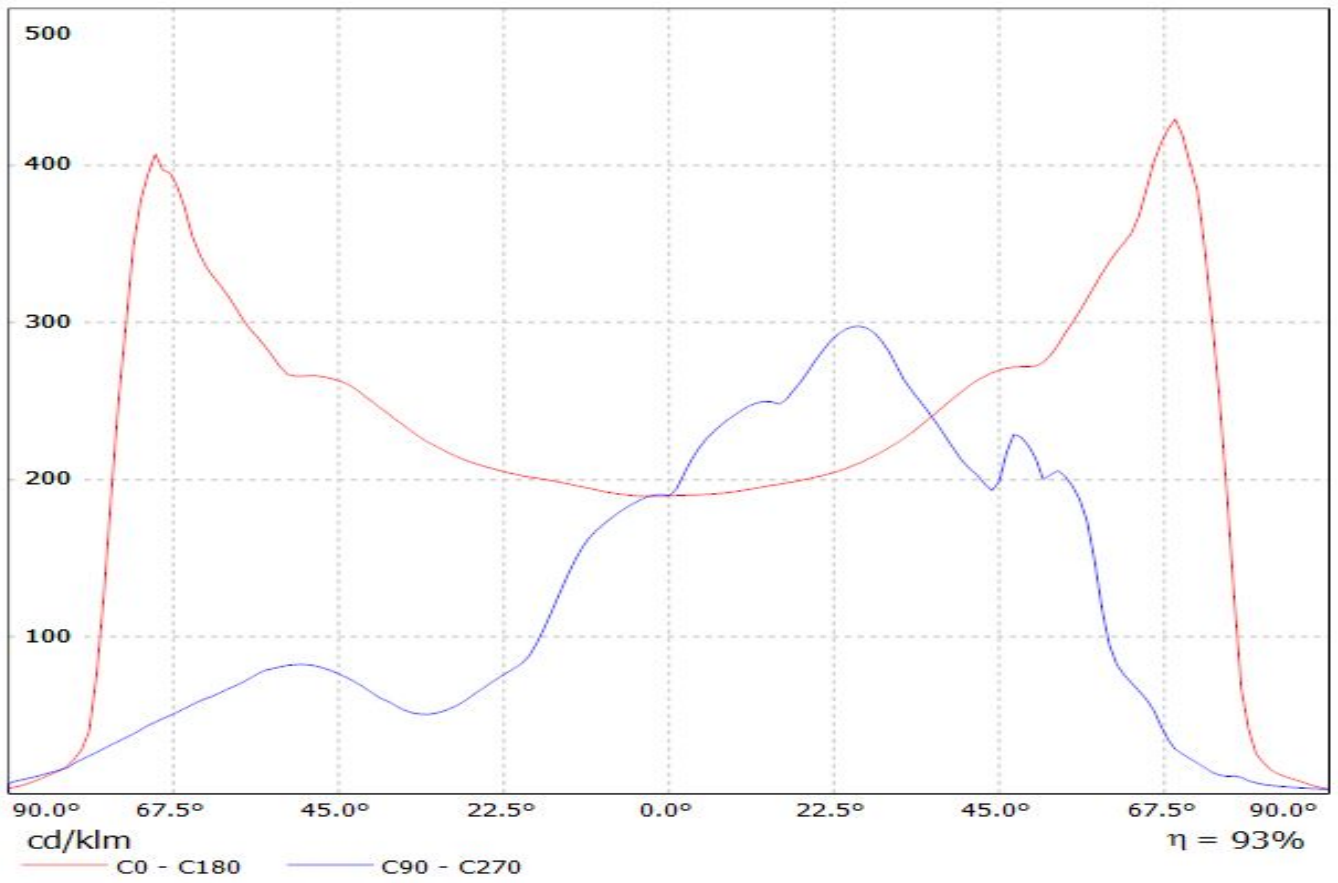

Luminaire: LEDiL Oy FN14825_STRADA-2X2MXS-DWC2_(Duris_S10)
Lamps: 1 x Osram_Duris_S10_1454.14lm@100mA_P=10.018W_I=0.100A

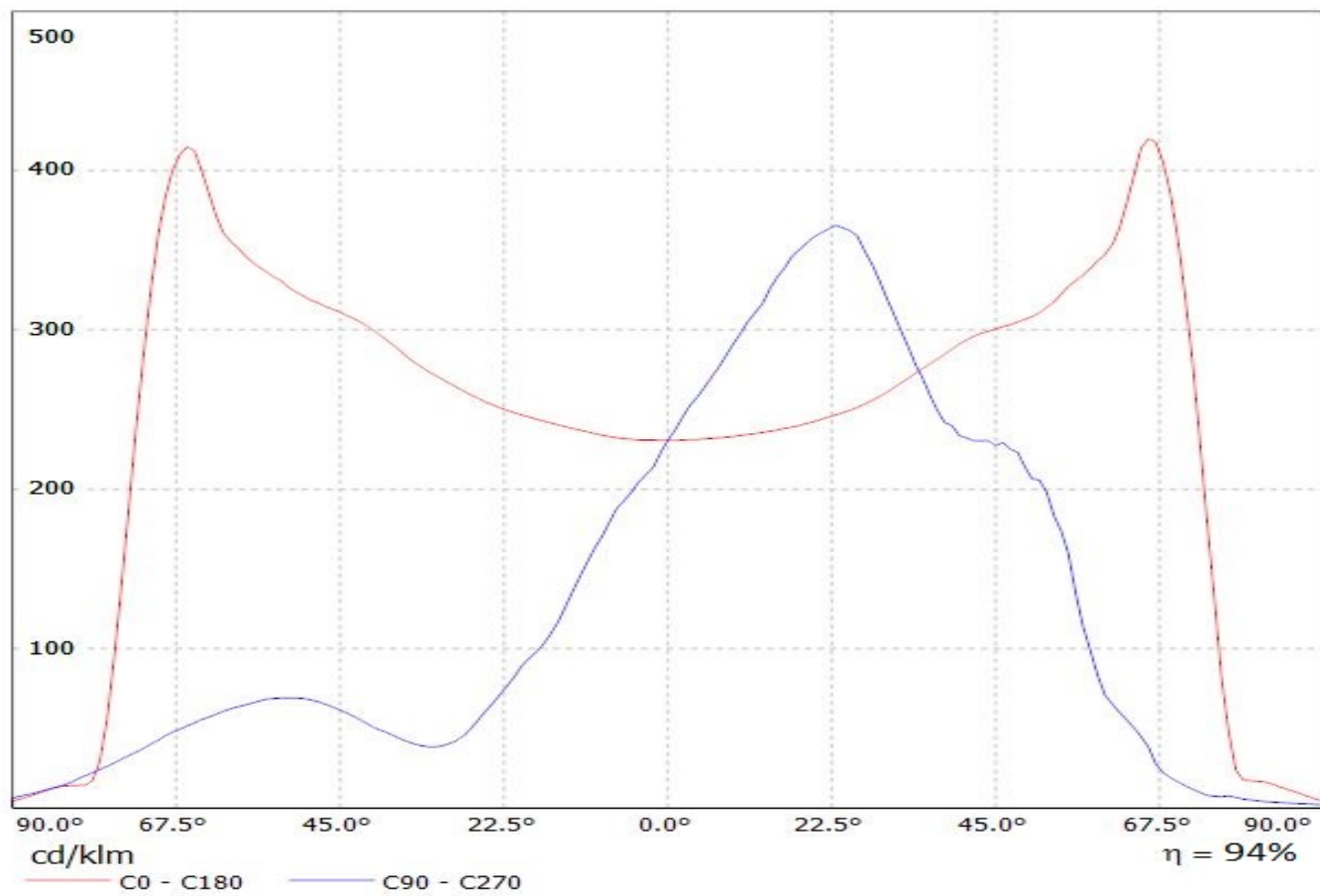

Luminaire: LEDiL Oy FN14825_STRADA-2X2MXS-DWC2_(PSL445)

Lamps: 1 x Citizen_PSL445_2x2_1674.9lm@250mA_P=11.1421W_I=0.250A_CCT=2700K

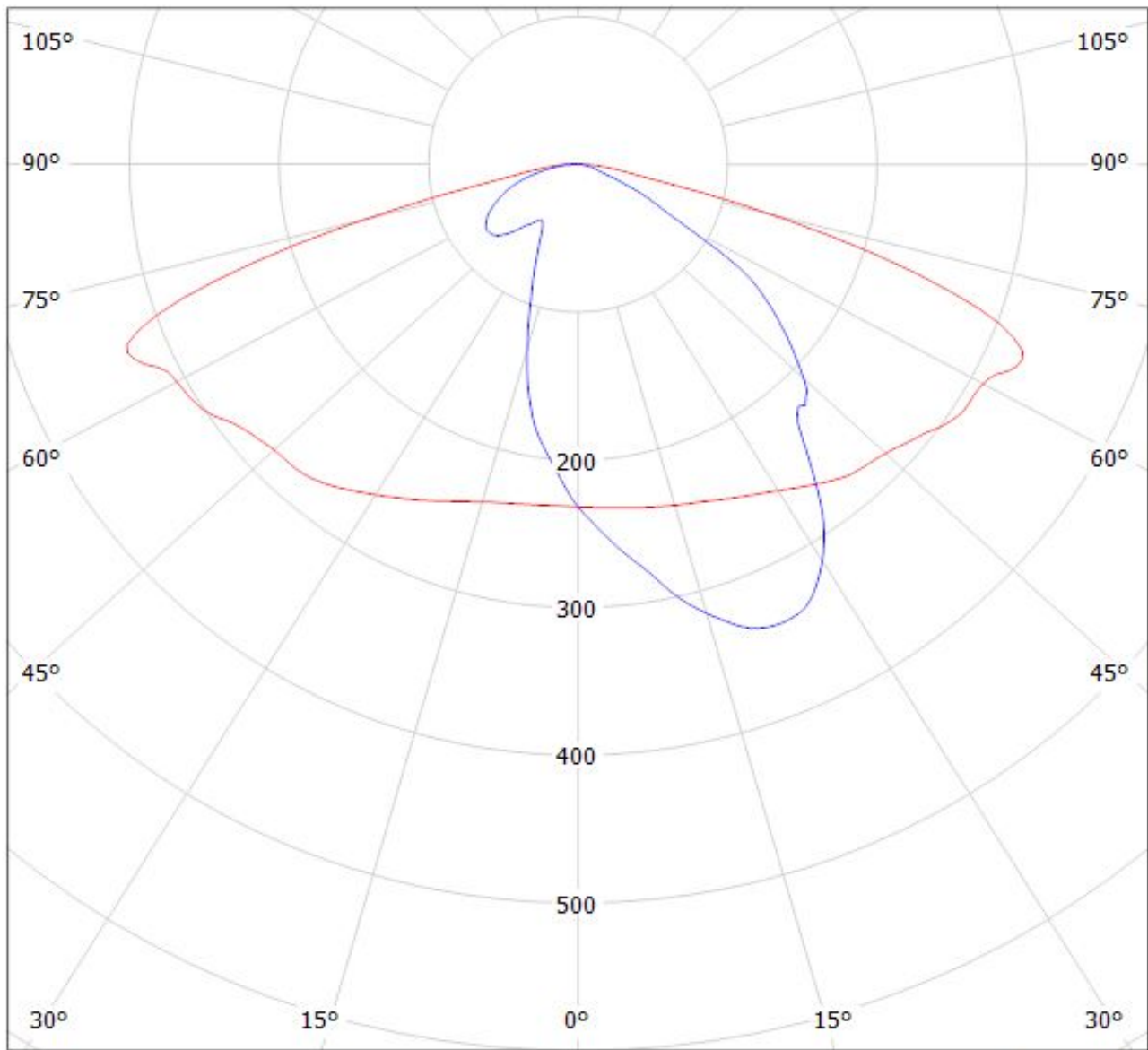

cd/klm

— C0 - C180 — C90 - C270

$\eta = 93\%$

Luminaire: Ledil FN14825_STRADA-2X2MXS-DWC2_(PSL440)

Lamps: 1 x Citizen_PSL440_1078.26lm@250mA_CCT=2700K_P=11.4122W_I=0.25A

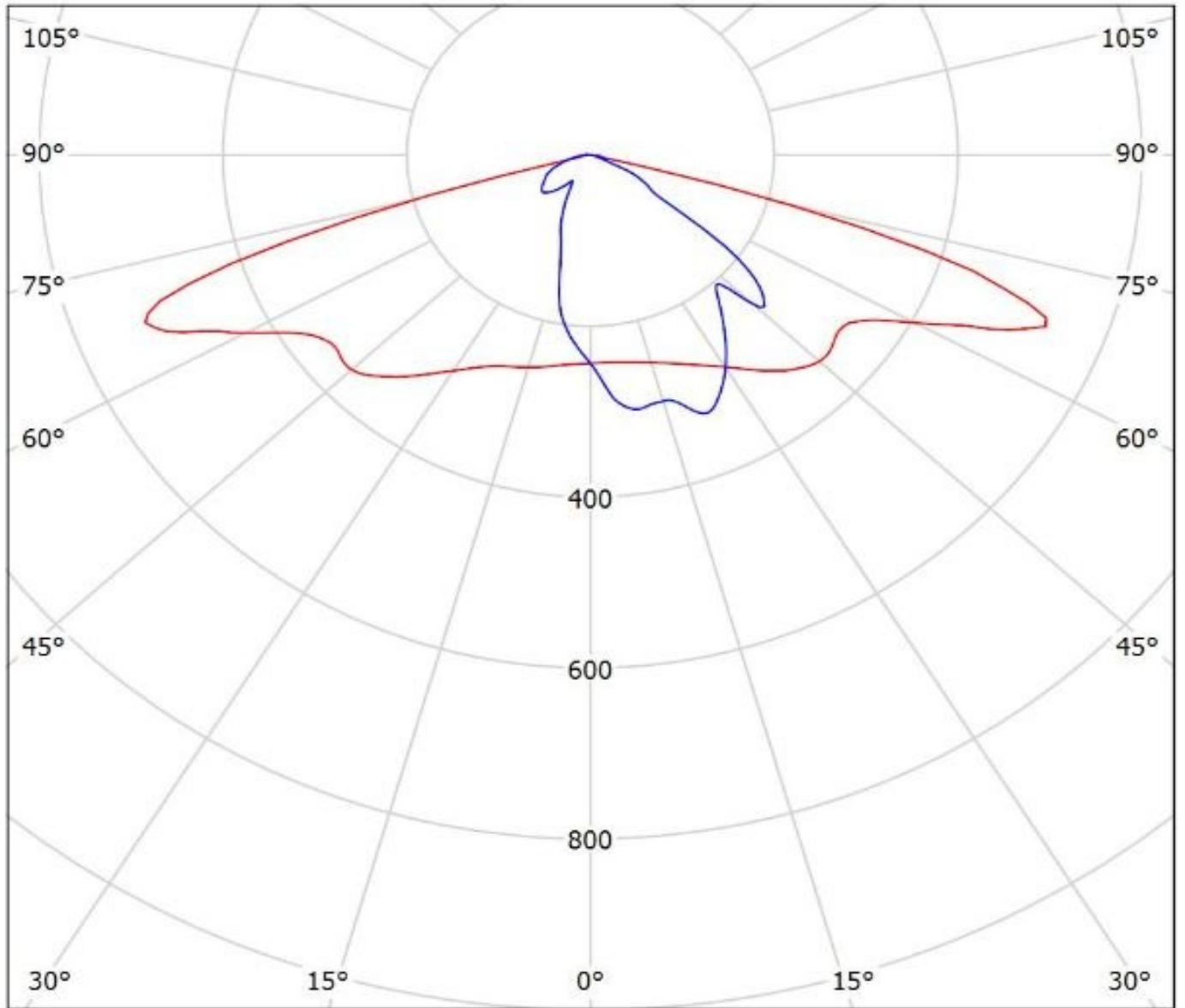

cd/klm

— C0 - C180

— C90 - C270

$\eta = 94\%$

Luminaire: LEDiL Oy FN14825_STRADA-2X2MXS-DWC2_(XHP70)
Lamps: 1 x Cree_XHP70-2X2MX_1465.47lm@250mA_P=10.968W_I=0.250A

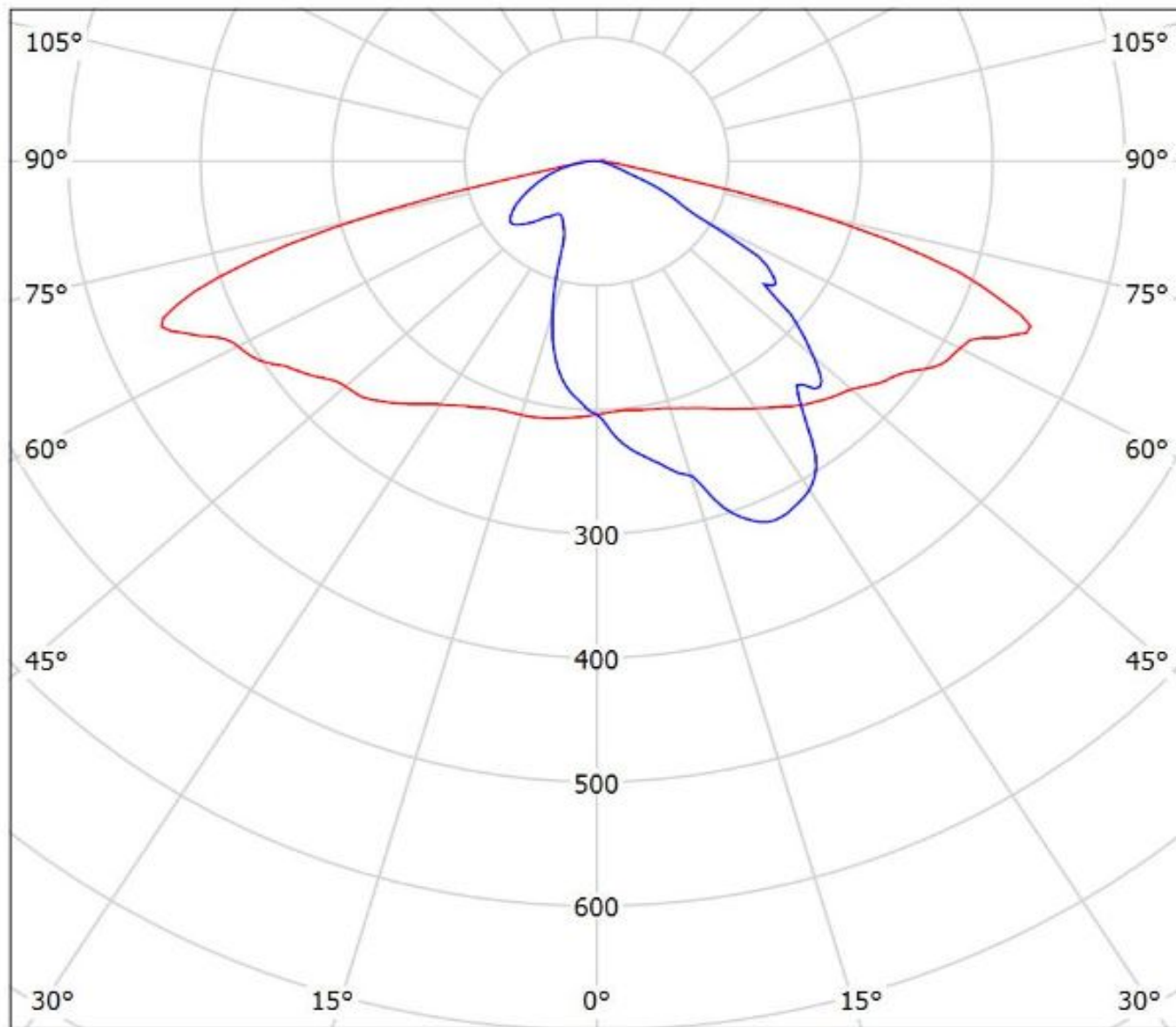

cd/klm
— C0 - C180 — C90 - C270

$\eta = 92\%$

Luminaire: LEDiL Oy FN14825_STRADA-2X2MXS-DWC2_(XHP35_HD)

Lamps: 1 x Cree_XHP35_HD_(XHP35A-0-2D0-D40-D0-B-01)_1724.66lm@250mA_P=11.3017W_I=0.250A

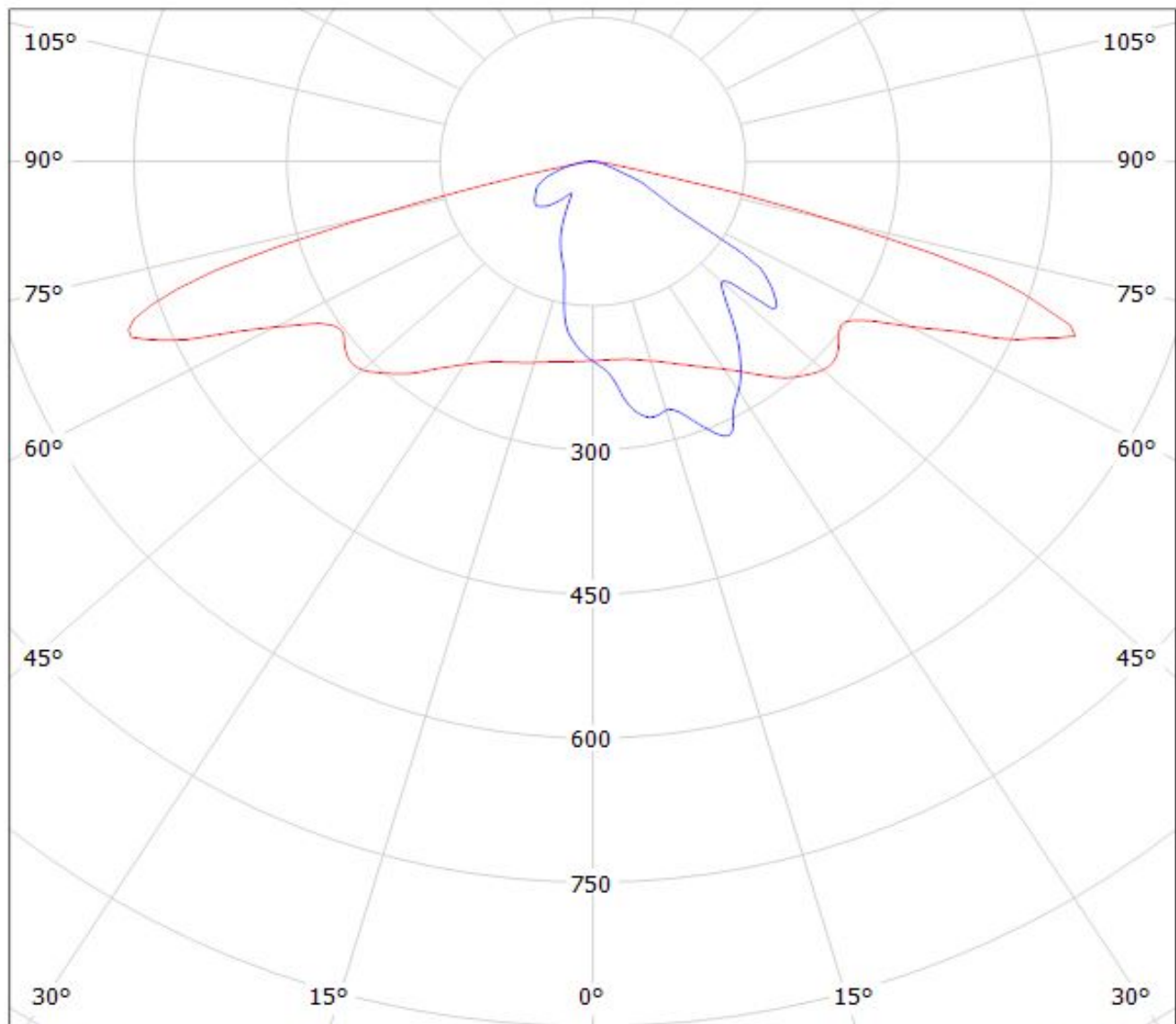

cd/klm

— C0 - C180

— C90 - C270

η = 92%

Luminaire: LEDiL Oy FN14825_STRADA-2X2MXS-DWC2_(XHP35_HI)
Lamps: 1 x Cree_XHP35_HI_(XHP35A-H-5C0-D40-D0-B-01)_1615.75lm@250mA_CCT=4000K_P=11.4373W_I=0.250A

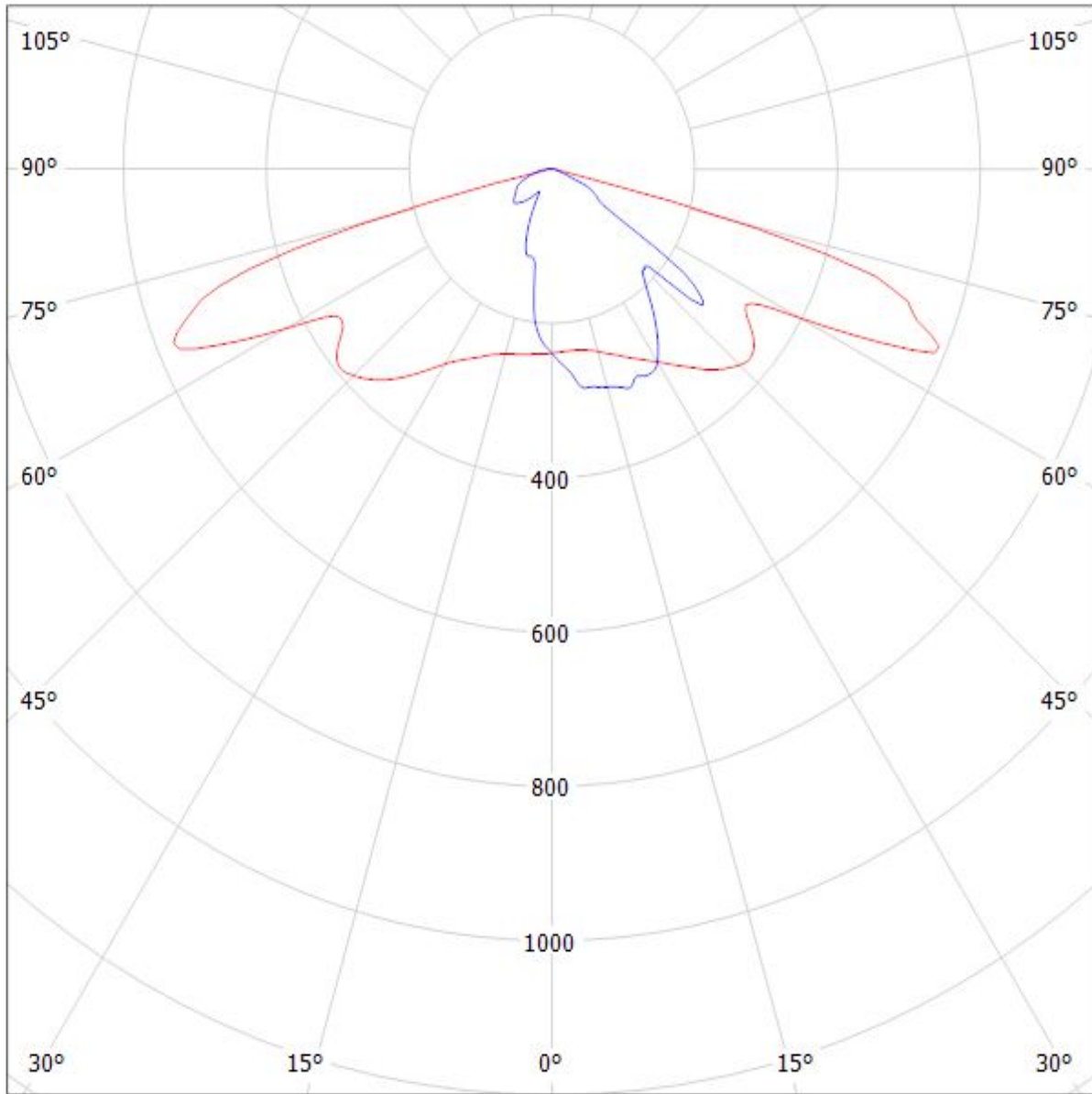

cd/klm

— C0 - C180 — C90 - C270

$\eta = 92\%$

Luminaire: LEDiL Oy FN14825_STRADA-2X2MXS-DWC2_(XHP50)

Lamps: 1 x Cree_XHP50_(XHP50-0-1B0-J20-D0-B-01)_1815.51lm@250mA_P=11.4658W_I=0.250A

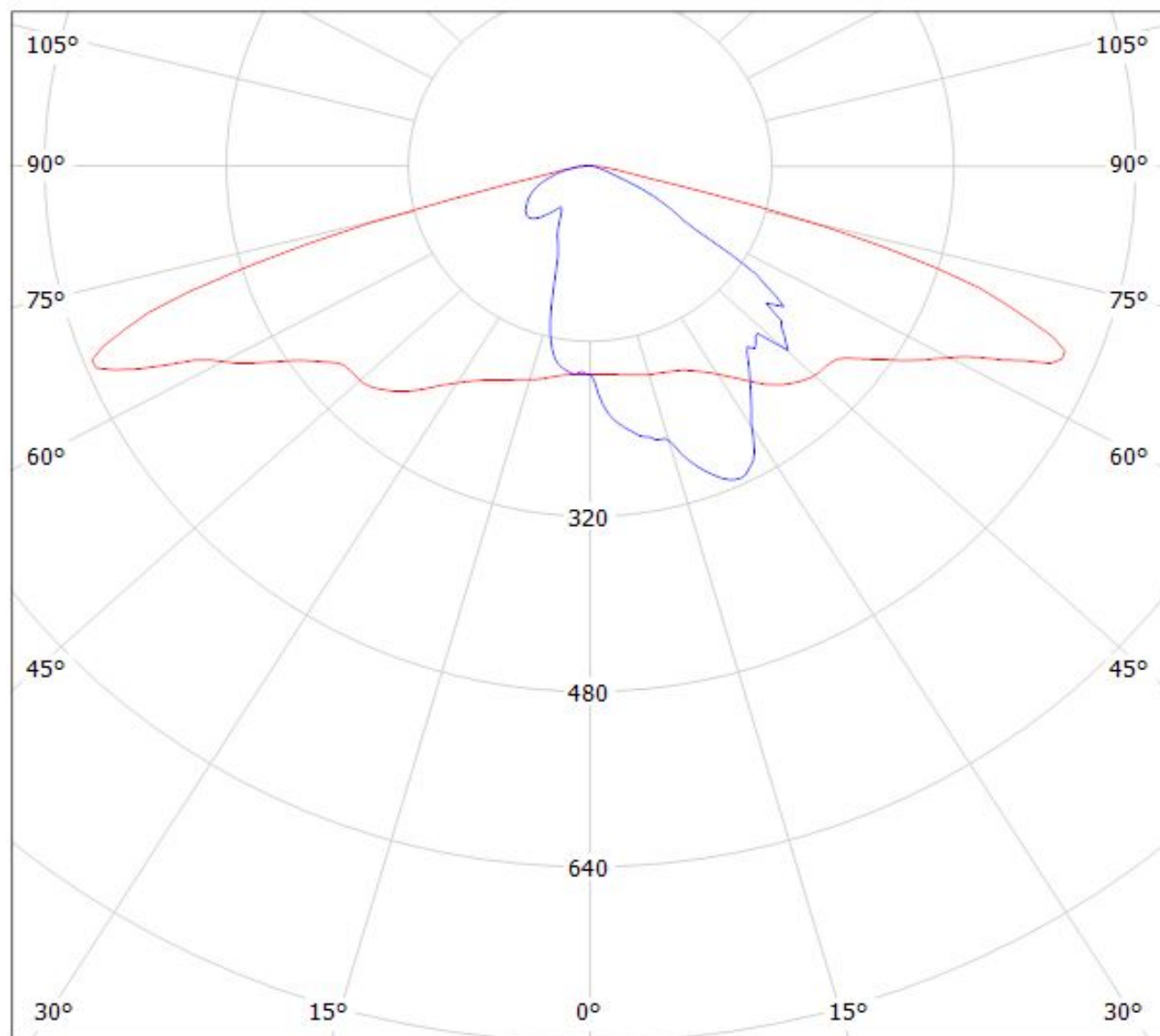

cd/klm

— C0 - C180

— C90 - C270

$\eta = 92\%$

Luminaire: LEDiL Oy FN14825_STRADA-2X2MXS-DWC2_(H70E0)
Lamps: 1 x LG_H70E0_1790.78lm@250mA_P=11.2987W_I=0.250A

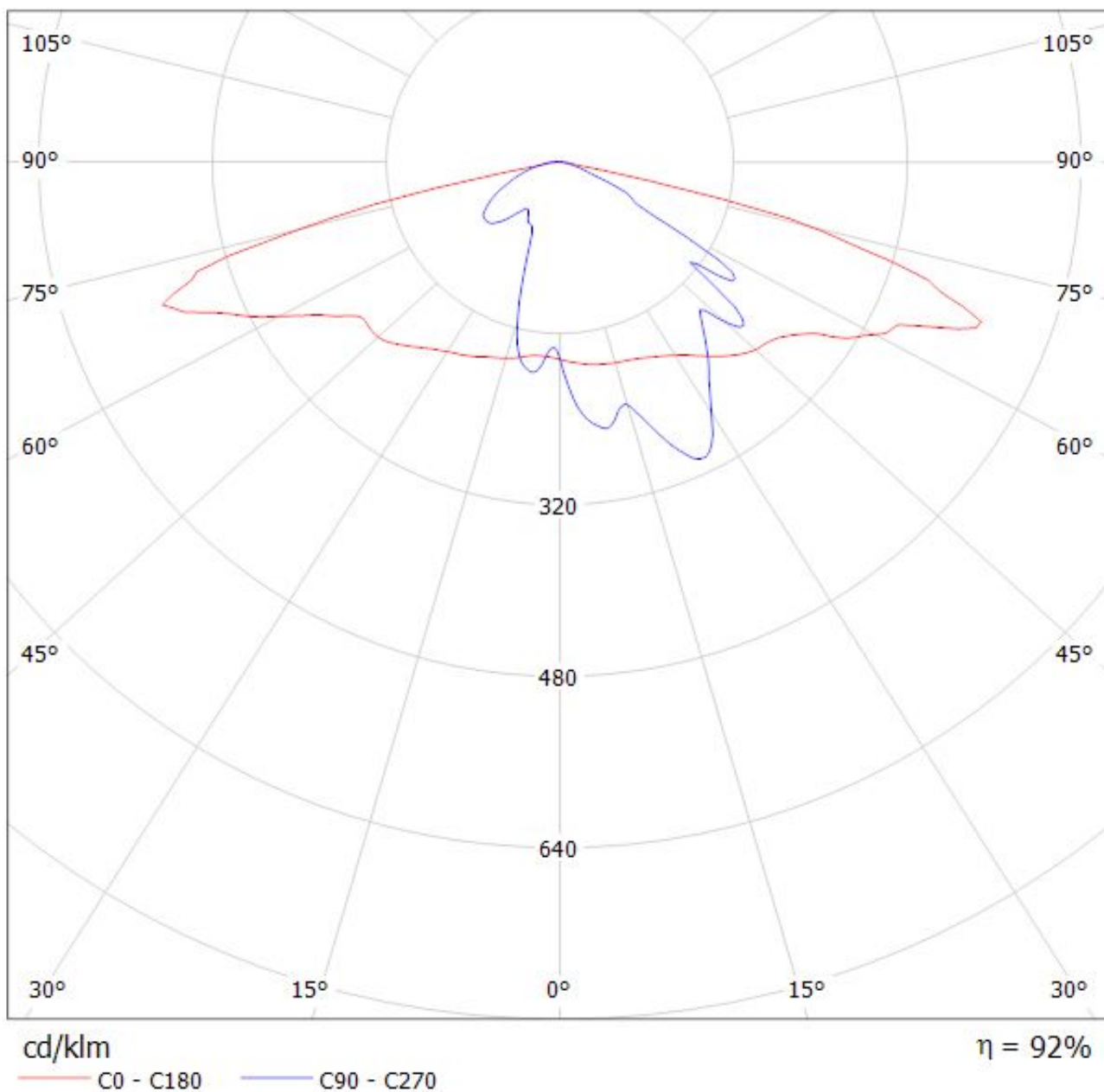

Luminaire: LEDiL Oy FN14825_STRADA-2X2MXS-DWC2_(Luxeon_M)
Lamps: 1 x Luxeon_M_1742.28lm@250mA_P=10.8298W_I=0.250A

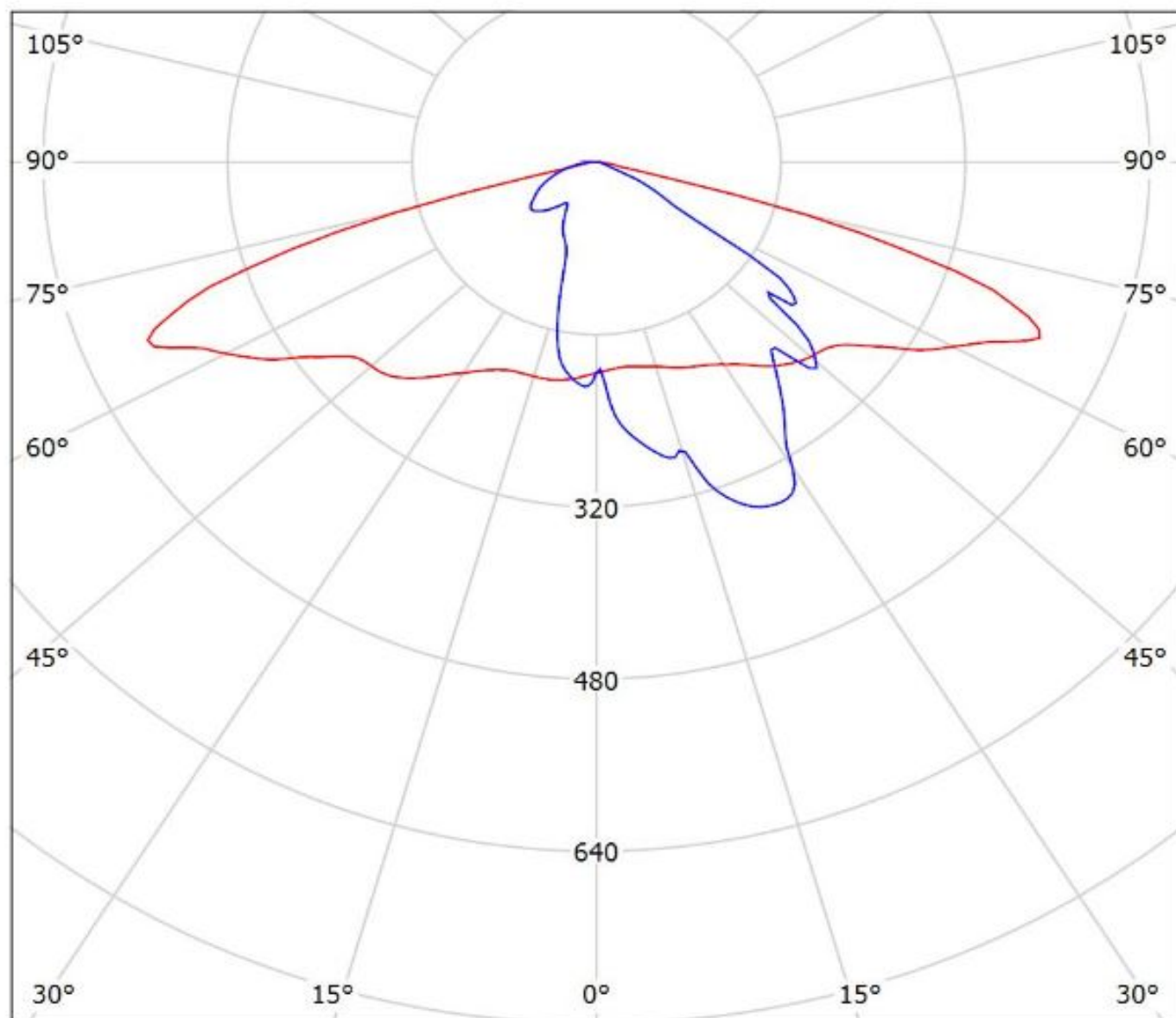

cd/klm

— C0 - C180 — C90 - C270

$\eta = 95\%$

Luminaire: Ledil FN14825_STRADA-2X2MXS-DWC2_(XR-M)

Lamps: 1 x Luxeon_XR-M_2x2_(L2M0-577004MC2200)_1806.51lm@250mA_P=10.9462W_I=0.25A

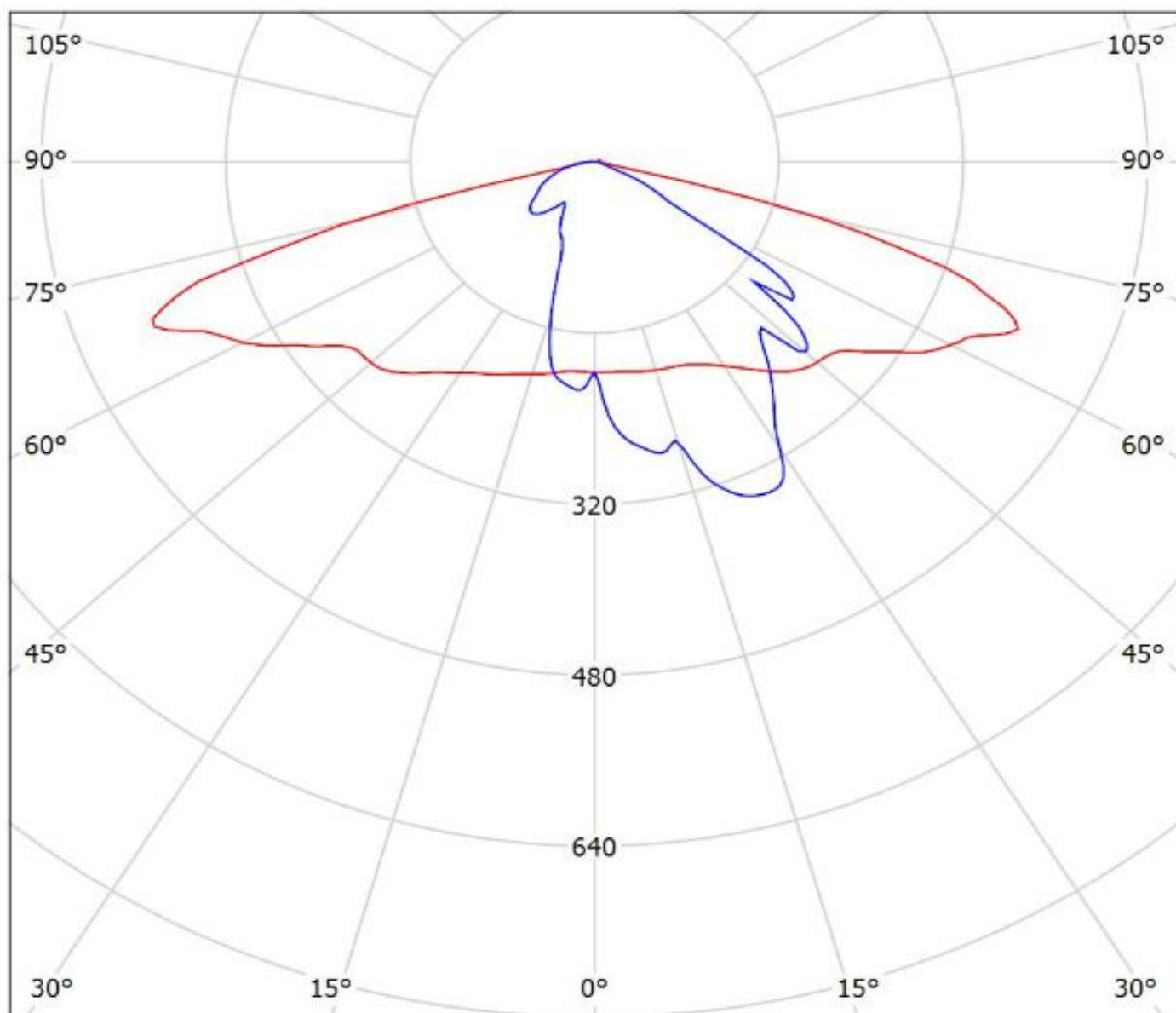

cd/klm

— C0 - C180 — C90 - C270

$\eta = 95\%$

Luminaire: Ledil FN14825_STRADA-2X2MXS-DWC2_(LUXEON_MZ)

Lamps: 1 x LUXEON_MZ_2X2_(LMZ9-SW30)_1377.64lm@250mA_CCT=3000K_P=11.05W_I=0.25A

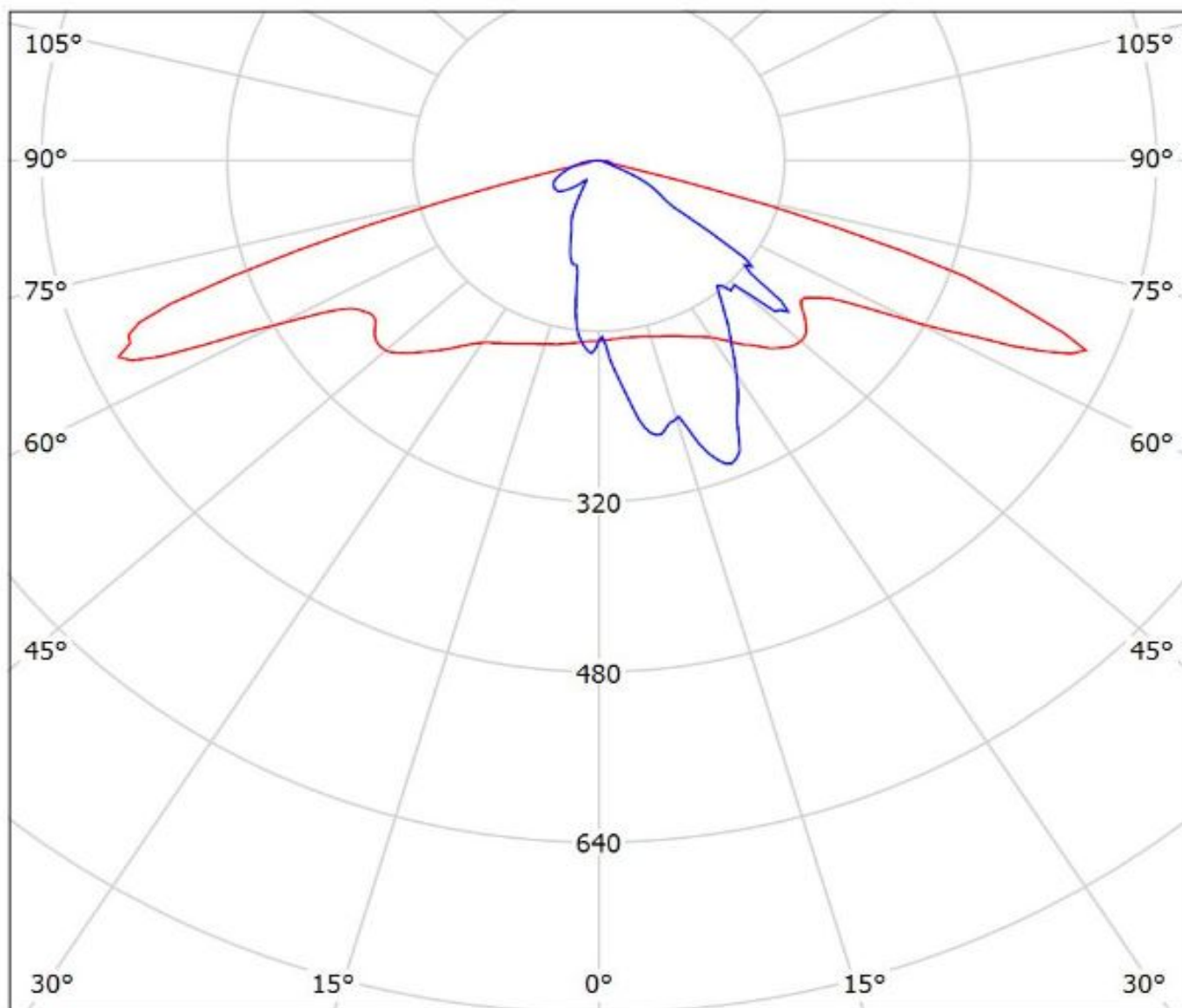

cd/klm

— C0 - C180 — C90 - C270

$\eta = 75\%$

Luminaire: LEDiL Oy FN14825_STRADA-2X2MXS-DWC2_(NV4x144A)

Lamps: 1 x Nichia_NV4x144A_(NV4W144AR)_1847lm@250mA_P=11.0074W_I=0.250A

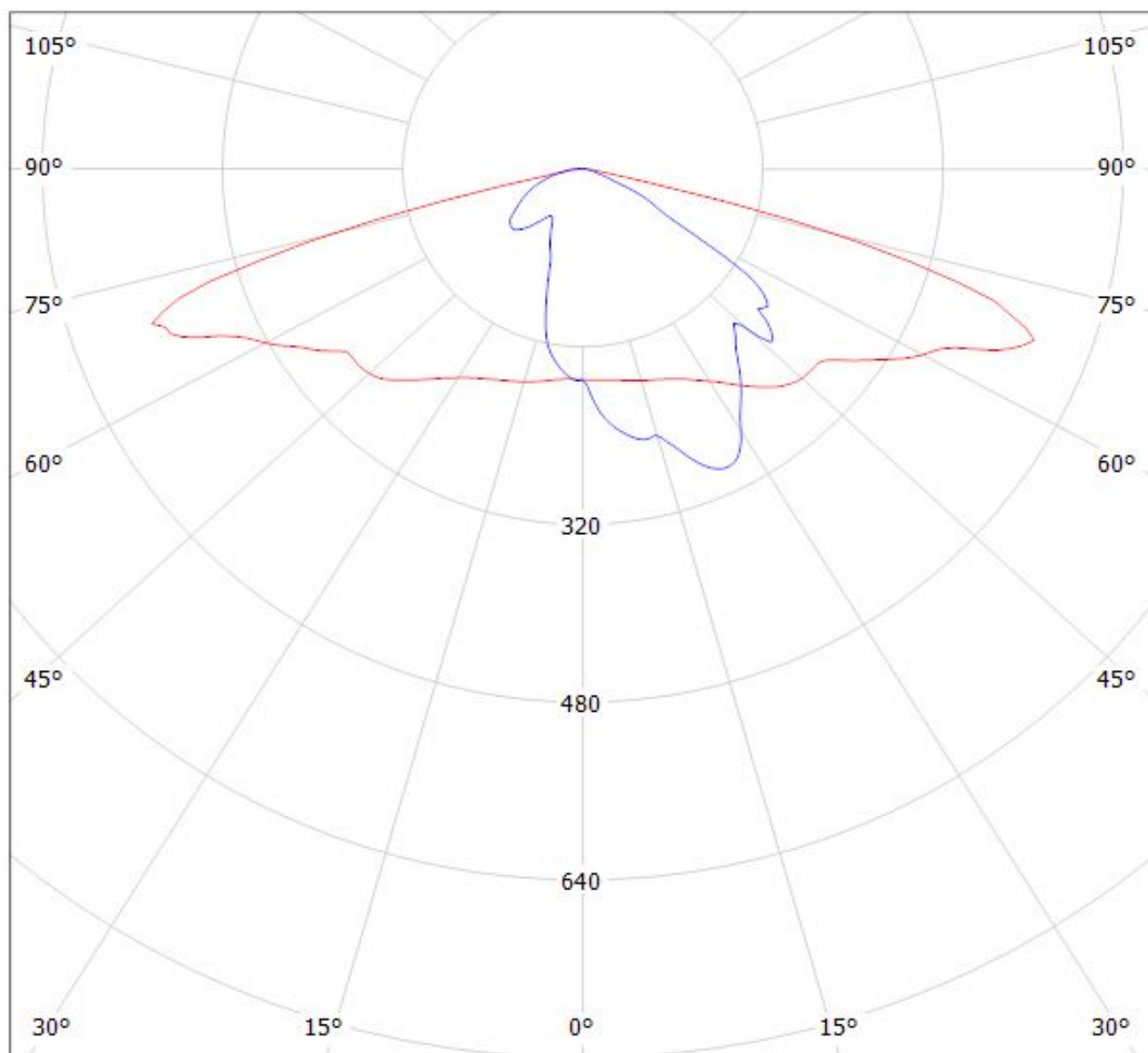

cd/klm

— C0 - C180

— C90 - C270

$\eta = 93\%$

Luminaire: Ledil Oy FN14825_STRADA-2X2MXS-DWC2_NFMW488AR_SIMULATED
Lamps: 1 x NICHIA NFMW488AR

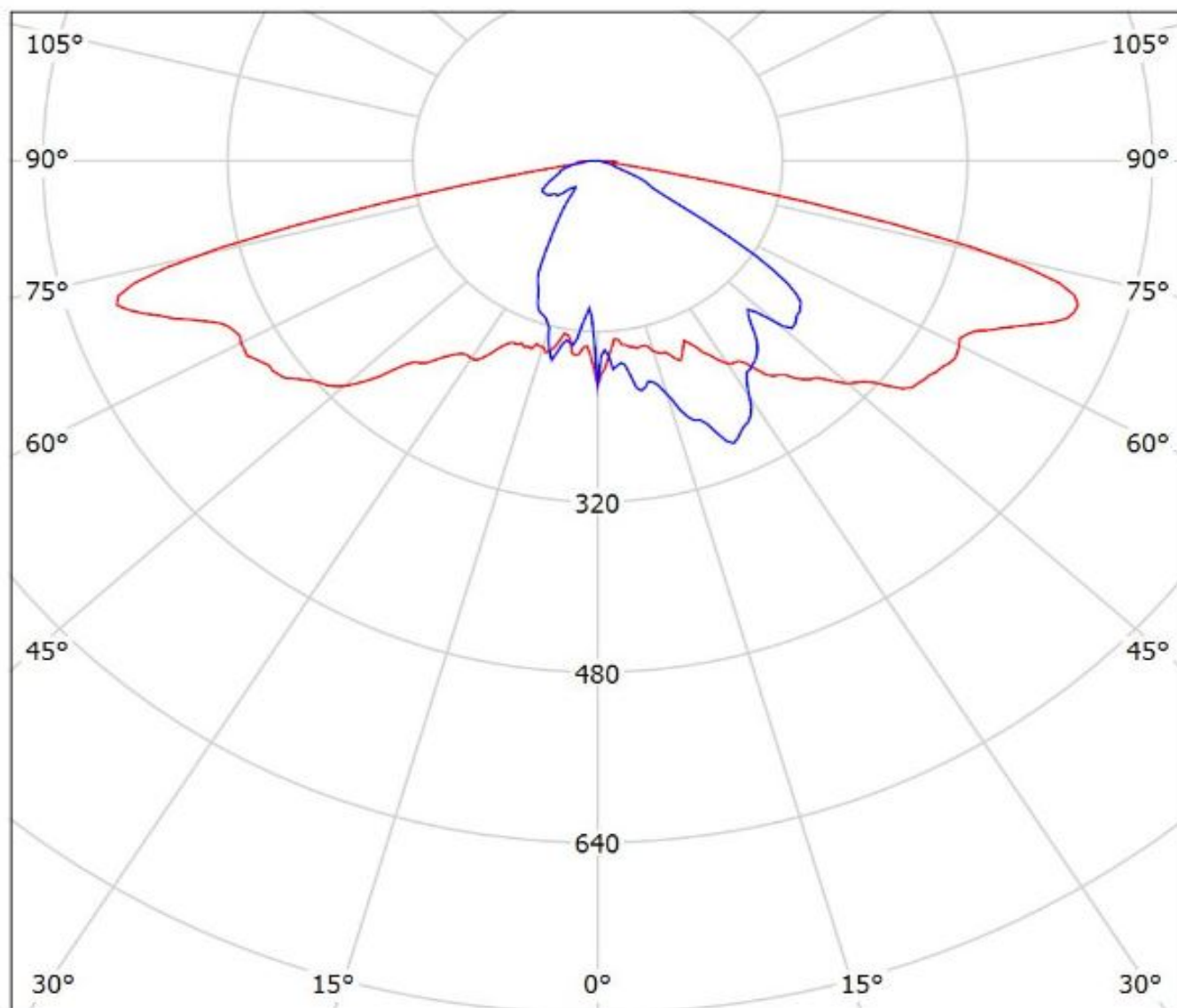

cd/klm
— C0 - C180 — C90 - C270

$\eta = 93\%$

Luminaire: LEDiL Oy FN14825_STRADA-2X2MXS-DWC2_(Duris_S10)
Lamps: 1 x Osram_Duris_S10_1454.14lm@100mA_P=10.018W_l=0.100A

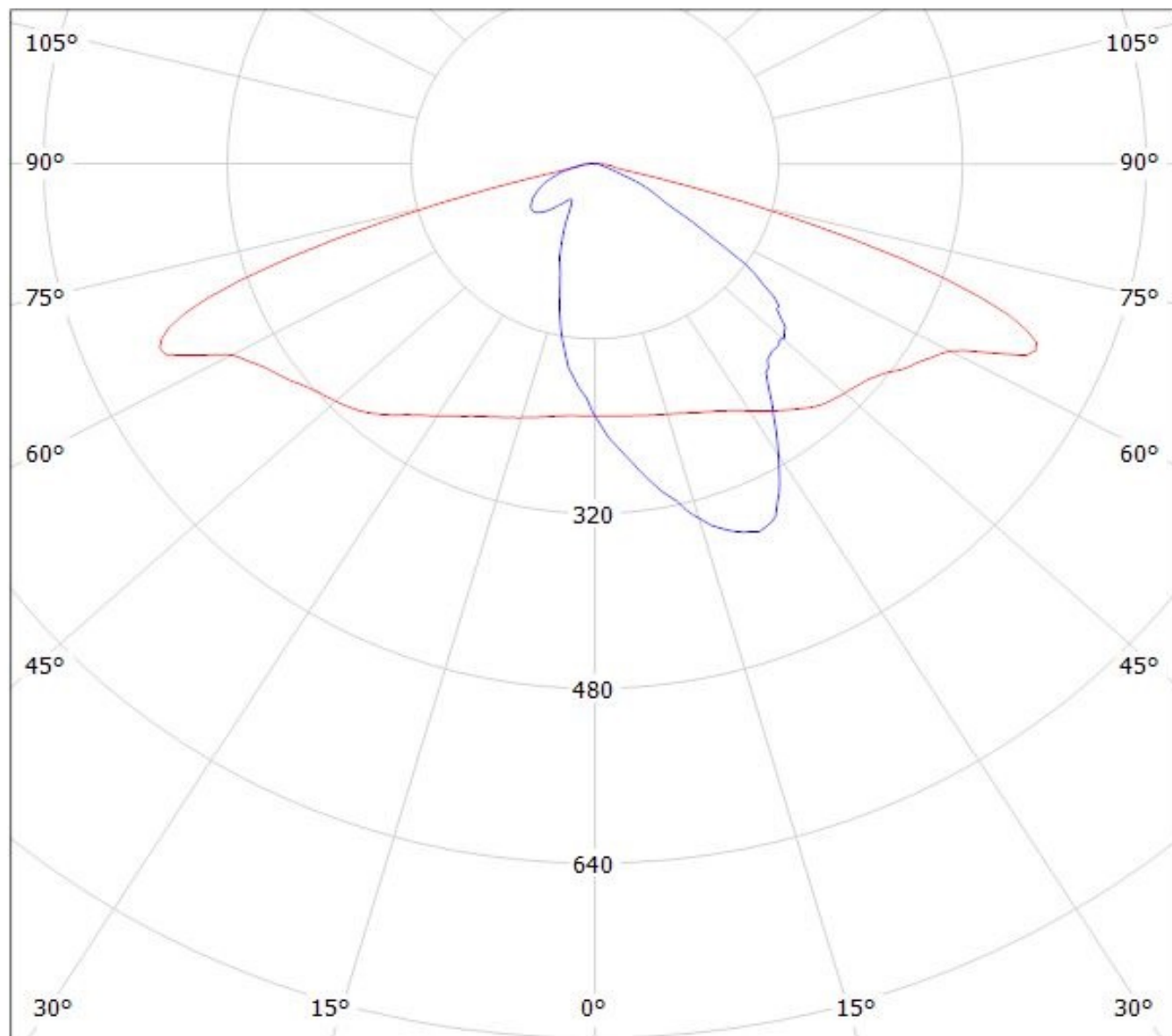

cd/klm
— C0 - C180 — C90 - C270

$\eta = 94\%$

NOTE: The typical divergence will be changed by different color, chip size and chip position tolerance. The typical total divergence is the full angle measured where the luminous intensity is half of the peak value.