



Figure 1. AQCL100MA410SE

### FEATURES

- Input Voltage Range: 10V~28V
- Output Voltage Range: 1V ~  $V_{VPS} - 4V$
- Maximum Output Current: 100mA
- Ultra Low Noise:  $0.125\mu A_{p-p}@0.1Hz \sim 10Hz$
- Input Voltage Polarity Reverse Protection
- Under-Voltage Protection
- Current Limit
- Over-Temperature Protection

High Absolute Accuracy:  $<0.1\%$  @  $0^{\circ}C \sim 50^{\circ}C$  ambient temperature

High Stability:  $<20ppm/^{\circ}C$

Control Loop Good Indication: LPGD

Output Current Real Time Monitoring: LIO

Complete Shielding

Compact Size: 49.4mm(L) $\times$ 45mm(W) $\times$ 14mm(H)

100 % Lead (Pb)-Free and RoHS Compliant

### APPLICATIONS

This QCL driver can be used to drive QCLs (Quantum Cascade Laser) for radar, medical diagnostics, spectroscopy, chemical analysis, general measurement systems, etc.

### DESCRIPTION

AQCL100MA410SE is a quantum cascade laser driver with single ended input control.

The AQCL100MA410SE is a chassis mount electronic module designed for driving QCLs. It delivers ultra-low noise current and still preserves a wide modulation bandwidth. The AQCL100MA410SE comes with protections for over-voltage, under-voltage, over current, and over temperature.

To monitor the working status of the laser driver, there is a control loop good indication pin, LPGD; and the output current monitor pin, LIO.

Figure 1 shows the physical photo of AQCL100MA410SE. The output voltage can swing from 0.5V to  $V_{VPS} - 4V$ , where  $V_{VPS} = V_{OUT} + 5V$ ,  $V_{VPS}$  is the power supply voltage and can be from 10V~28V.

Figure 2 shows the relationship between the output voltage and power supply voltage.

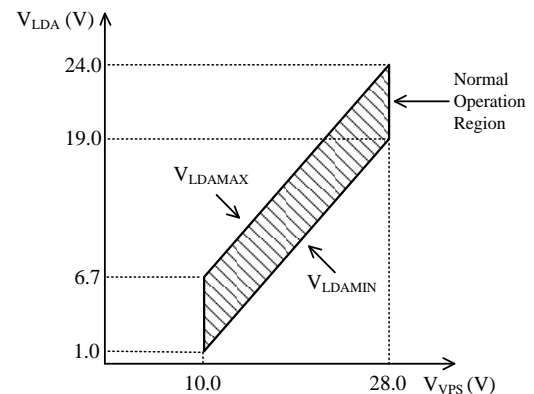

Note:  $I_{MAX} = 100mA$

Figure 2.  $V_{VPS}$  VS.  $V_{LDA}$



Table 1. Terminal Block Connector 1 Pin Function Descriptions

Pin #	Pin Name	Port Type	Description
1	DATA-	Analog input	NC
2	DATA+	Analog input	NC
3	1.2VR	Analog output	NC
4	GND	Signal ground	Signal ground. Connect this pin to the signal ground of ADCs, DACs, and the signal sources.
5	LPGD	Digital output	Loop good indication. When outputting a high logic level 5V, it indicates the control loop works properly, i.e. the output current equals the set-point value; outputting a logic low level indicates there is something wrong in the control loop, such as open circuit, output current equals zero, etc.
6	SBDN	Digital input	This is a duplex pin: when it is pulled down <0.4V, the controller is put into Shut-down Mode; when setting this pin to between 1.2V to 2.5V, the controller is set to Stand-by Mode. In this mode, the voltage reference is still working; when setting it to >2.64V to VPS voltage, the controller goes to On Mode. There is an internal 20MΩ pull up resistor tied to VPS.
7	GND	Signal ground	Signal ground. Connect this pin to the signal ground of ADCs, DACs, and the signal sources.
8	4VR	Analog output	Voltage Reference 4.096V output. It can be used by external POTs (Potentiometer), DACs and/or ADCs for setting the LIS. Under Stand-by Mode, this pin is still working.
9	ILM	Analog input	Laser current limit set. 0V to 4.096 V sets the laser current limit from 0 to 100mA linearly. The internal input impedance is 1M.
10	LIS	Analog input	Laser current setting indication. 0V to 4.096 V indicates the laser current is set from 0 to 100mA linearly.
11	LIO	Analog output	Laser current output indication. 0V to 4.096 V indicates the laser current from 0 to 100mA linearly.
12	TMO	Analog output	The controller internal temperature indication output. It can be used for sensing the actual temperature of the controller to avoid over-heating. 0V to 4V represents the controller temperature from -55°C to 125°C.

Table 2. Terminal Block Connector 4 Pin Function Descriptions

Pin #	Pin Name	Port Type	Description
1	LDA	Analog output	Laser diode anode. Connect it to the anode of the laser diode.
2	LDC	Analog output	Laser diode cathode. Connect it to the cathode of the laser diode. This pin is internally connected to PGND and GND, thus its voltage potential is zero.
3	GND	Signal ground	Signal ground. Connect this pin to the signal ground of ADCs, DACs, and the signal sources.
4	PGND	Power ground	Power ground pin. Connect it directly to power supply return rail.
5	VPS	Power input	Power supply voltage. The driver works from 10V to 28V.



Table 3. Competition Comparison

Parameter	Competition QCL driver	ATI QCL driver
Number of power supplies required	2	1
Input voltage range	25V	10~28V
Output voltage range	5V	1V~V <sub>VPS</sub> -4V
Over current protection	No	Yes
Polarity reverse protection	No	Yes
Size	140×166×58 (mm)	50×45×14 (mm)
Weight	1,000g	45g

**SPECIFICATIONS**

Table 4. Characteristics (T<sub>A</sub>= 25°C)

Parameter	Symbol	Conditions	Min.	Typ.	Max.	Units
Control SBDN Pin (# 6 of Terminal Block Connector 1)						
SBDN Voltage	V <sub>SBDN-ON</sub>		2.64		V <sub>VPS</sub>	V
	V <sub>SBDN-STANDBY</sub>		1.2		2.5	V
	V <sub>SBDN-OFF</sub>		0		0.4	V
	V <sub>SBDN-SB-HI</sub> Going up from Standby to On threshold voltage		2.508		2.64	V
	V <sub>SBDN-SB-LOW</sub> Going down from On to Standby threshold voltage		2.5		2.6	V
	V <sub>SBDN-OFF-HI</sub> Going up from Off to Standby threshold voltage				1.2	V
	V <sub>SBDN-OFF-LOW</sub> Going down from Standby to Off threshold voltage			0.4		V
Pull-up Resistor to VPS				20		MΩ
Current Setting LIS Pin (# 10 of Terminal Block Connector 1)						
Current Set Voltage			0		4.096	V
Output LDA Pin (# 1 of Terminal Block Connector 2)						
Output Voltage	V <sub>LDA</sub>		1		V <sub>VPS</sub> -4	V
Output Current	I <sub>LDA</sub>		0		100	mA
Output Current Noise	I <sub>NLDA</sub>	Peak-to-peak value, 0.1Hz to 10Hz		0.5		μA <sub>P-P</sub>
Minimum Dropout Voltage	V <sub>VPS</sub> - V <sub>LDA</sub>			4		V



Parameter	Symbol	Conditions	Min.	Typ.	Max.	Units
Output LDA Pin (# 1 of Terminal Block Connector 2)						
Operating Ambient Temperature Range	T <sub>A</sub>		-40		65	°C
Large Signal Bandwidth	f <sub>lg</sub>			1		MHz
Small Signal Bandwidth	f <sub>sm</sub>			1		MHz
Small Signal Rise and Fall Times	t <sub>smr</sub> , t <sub>smf</sub>			350		ns
Large Signal Rise and Fall Times	t <sub>lgr</sub> , t <sub>lgf</sub>			350		ns
Power Supply Input VPS Pin (# 5 of Terminal Block Connector 2)						
Input Voltage Range	V <sub>VPS</sub>		10		28	V
Input Current	I <sub>VPS</sub>		0		600	mA

Table 5. V<sub>LIS</sub> & I<sub>OUT</sub>

V <sub>LIS</sub>	I <sub>OUT</sub>
4.096V	100mA
2.048V	50mA
0V	0mA

$$I_{OUT} = \frac{V_{LIS}}{4.096V} \times 100mA$$

V<sub>LIS</sub>: The voltage for setting the laser current.

I<sub>OUT</sub>: The output current.

Insert the screwdriver into the upper card slot, and the lower card slot should be inserted with a power cord with a bare core (φ = 1.5mm ±0.2mm; L = 7.5mm ±0.2mm).

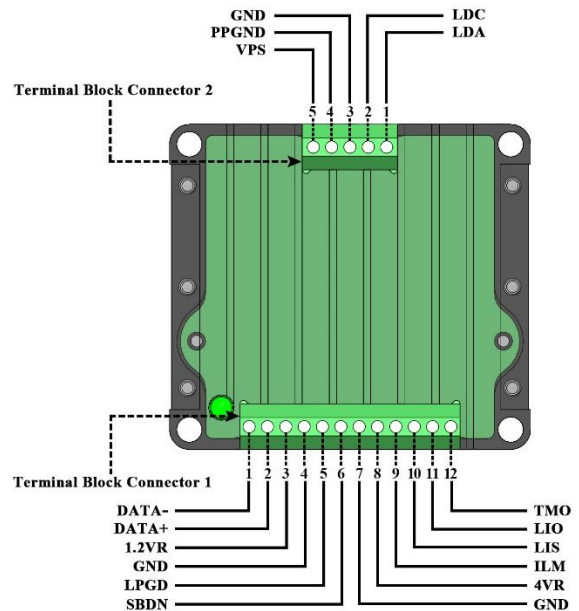

Figure 3. Top View of AQCL100MA410SE











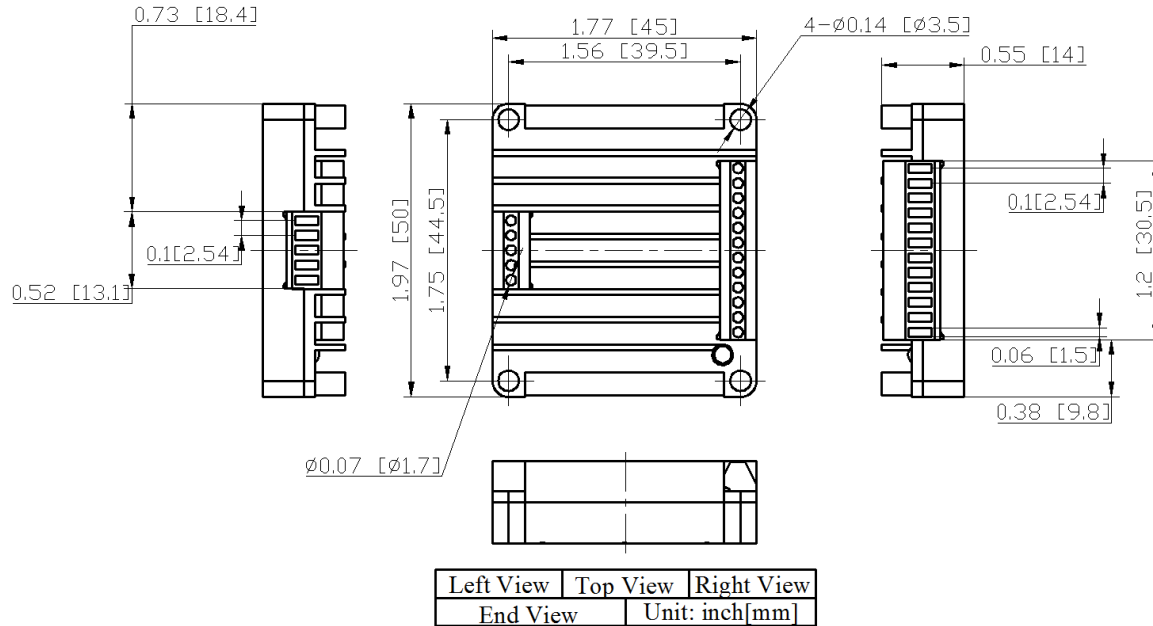

















**MECHANICAL DIMENSIONS**

Figure 6. Dimensions of AQCL100MA410SE

**RELATED PRODUCTS**

Table 6. Unit Price

Part #	Datasheet	Output Voltage (V)	Output Current (mA)	Description	Buy Now
AQCL100MA410SE		10~28	100	100mA module with single ended input control	 * 
AQCL200MA410SE		10~28	200	200mA module with single ended input control	 * 
AQCL500MA410SE		10~28	500	500mA module with single ended input control	 * 
AQCL1A410SE		10~28	1000	1A module with single ended input control	 * 
AQCL2A410SE		10~28	2000	2A module with single ended input control	 * 
AQCL3A410SE		10~28	3000	3A module with single ended input control	 * 
AQCL100MA410DF		10~28	100	100mA module with differential analog input control	 * 
AQCL200MA410DF		10~28	200	200mA module with differential analog input control	 * 
AQCL500MA410DF		10~28	500	500mA module with differential analog input control	 * 



**NOTICE**

1. ATI warrants performance of its products for one year to the specifications applicable at the time of sale, except for those damaged by excessive abuse. Products found not meeting the specifications within one year from the date of sale can be exchanged free of charge.
2. ATI reserves the right to make changes to its products or to discontinue any product or service without notice, and advise customers to obtain the latest version of relevant information to verify, before placing orders, that information being relied on is current and complete.
3. All products are sold subject to the terms and conditions of sale supplied at the time of order acknowledgment, including those pertaining to warranty, patent infringement, and limitation of liability. Testing and other quality control techniques are utilized to the extent ATI deems necessary to support this warranty. Specific testing of all parameters of each device is not necessarily performed, except those mandated by government requirements.
4. Customers are responsible for their applications using ATI components. In order to minimize risks associated with the customers' applications, adequate design and operating safeguards must be provided by the customers to minimize inherent or procedural hazards. ATI assumes no liability for applications assistance or customer product design.
5. ATI does not warrant or represent that any license, either expressed or implied, is granted under any patent right, copyright, mask work right, or other intellectual property right of ATI covering or relating to any combination, machine, or process in which such products or services might be or are used. ATI's publication of information regarding any third party's products or services does not constitute ATI's approval, warranty or endorsement thereof.
6. IP (Intellectual Property) Ownership: ATI retains the ownership of full rights for special technologies and/or techniques embedded in its products, the designs for mechanics, optics, plus all modifications, improvements, and inventions made by ATI for its products and/or projects.