

ADC32RF5x Dual Channel 14-bit 2.6 to 3-GSPS RF Sampling Data Converter

1 Features

- 14-Bit, dual channel 2.6/3.0-GSPS ADC
- Noise spectral density:
 - NSD = -155.6 dBFS/Hz (no AVG)
 - NSD = -158.1 dBFS/Hz (2x AVG)
 - NSD = -160.4 dBFS/Hz (4x AVG)
- Single core (non-interleaved) ADC architecture
- Aperture jitter: 50 fs
- Low close-in residual phase noise:
 - -127 dBc/Hz at 10 kHz offset
- Spectral performance ($f_{IN} = 1 \text{ GHz}$, -4 dBFS):
 - 2x internal averaging
 - SNR: 62.3 dBFS
 - SFDR HD2,3: 63 dBc
 - SFDR worst spur: 85 dBFS
- Spectral performance ($f_{IN} = 1.8 \text{ GHz}$, -4 dBFS):
 - 2x internal averaging
 - SNR: 63.0 dBFS
 - SFDR HD2,3: 68 dBc
 - SFDR worst spur: 86 dBFS
- Input fullscale: 1.1/1.35 V_{pp} (2/3.5 dBm)
- Code error rate (CER): 10^{-15}
- Full power input bandwidth (-3 dB): 2.75 GHz
- JESD204B serial data interface
 - Maximum lane rate: 13 Gbps
 - Supports subclass 1 deterministic latency
- Digital down-converters
 - Up to four DDC per ADC channel
 - Complex output: 4x to 128x decimation
 - 48-bit NCO phase coherent frequency hopping
 - Fast frequency hopping: < 1 μ s
- Power consumption: 2.6 W/channel (2x AVG)
- Power supplies: 1.8 V, 1.2 V

2 Applications

- Phased array radar
- Spectrum analyzer
- Software defined radio (SDR)
- [Electronic warfare](#)
- High-speed digitizer
- Cable infrastructure
- Communications infrastructure

3 Description

The ADC32RF5x is a single core 14-bit, 2.6 GSPS to 3 GSPS, dual channel analog to digital converters (ADC) that supports RF sampling with input frequencies up to 3 GHz. The design maximizes signal-to-noise ratio (SNR) and delivers a noise spectral density of -155 dBFS/Hz. Using additional internal ADCs along with on-chip signal averaging, the noise density improves to -161 dBFS/Hz.

Each ADC channel can be connected to a quad-band digital down-converter (DDC) using a 48-bit NCO which supports phase coherent frequency hopping. Using the GPIO pins for NCO frequency control, frequency hopping can be achieved in less than 1 μ s.

The ADC32RF54 and ADC32RF55 supports the JESD204B serial data interface with subclass 1 deterministic latency using data rates up to 13 Gbps.

The power efficient ADC architecture consumes 2.1 W/ch at 3 Gbps and provides power scaling with lower sampling rates.

Package Information

PART NUMBER	PACKAGE ⁽¹⁾	BODY SIZE (NOM)
ADC32RF5x	VQFN (64)	9.00 mm x 9.00 mm

(1) For all available packages, see the package option addendum at the end of the data sheet.

Table 3-1. Device Comparison

PART NUMBER	SAMPLING RATE
ADC32RF55	3.0 GSPS
ADC32RF54 ⁽¹⁾	2.6 GSPS

(1) Product preview.

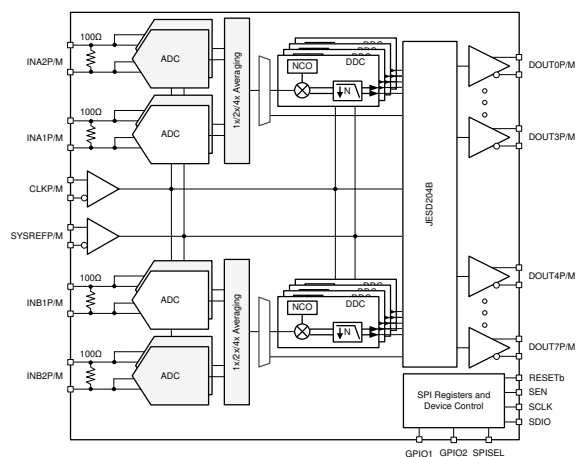

Block Diagram

Table of Contents

1 Features	1	6.13 Typical Characteristics - ADC32RF55.....	29
2 Applications	1	7 Detailed Description	39
3 Description	1	7.1 Overview.....	39
4 Revision History	2	7.2 Functional Block Diagram.....	39
5 Pin Configuration and Functions	3	7.3 Feature Description.....	40
6 Specifications	5	7.4 Device Functional Modes.....	73
6.1 Absolute Maximum Ratings.....	5	7.5 Programming.....	74
6.2 ESD Ratings.....	5	7.6 Register Maps.....	76
6.3 Recommended Operating Conditions.....	5	8 Application and Implementation	100
6.4 Thermal Information.....	6	8.1 Application Information.....	100
6.5 Electrical Characteristics - Power Consumption.....	7	8.2 Typical Applications.....	100
6.6 Electrical Characteristics - DC Specifications.....	8	8.3 Initialization Set Up.....	103
6.7 Electrical Characteristics - ADC32RF54 AC Specifications (Dither DISABLED).....	10	8.4 Power Supply Recommendations.....	113
6.8 Electrical Characteristics - ADC32RF54 AC Specifications (Dither ENABLED).....	12	8.5 Layout.....	115
6.9 Electrical Characteristics - ADC32RF55 AC Specifications (Dither DISABLED).....	14	9 Device and Documentation Support	117
6.10 Electrical Characteristics - ADC32RF55 AC Specifications (Dither ENABLED).....	16	9.1 Receiving Notification of Documentation Updates..	117
6.11 Timing Requirements.....	18	9.2 Support Resources.....	117
6.12 Typical Characteristics - ADC32RF54.....	20	9.3 Trademarks.....	117
		9.4 Electrostatic Discharge Caution.....	117
		9.5 Glossary.....	117
		10 Mechanical, Packaging, and Orderable Information	117

4 Revision History

NOTE: Page numbers for previous revisions may differ from page numbers in the current version.

Changes from Revision * (June 2022) to Revision A (December 2022)	Page
• Added ADC32RF55 to the document as <i>Production</i> data.....	1

5 Pin Configuration and Functions

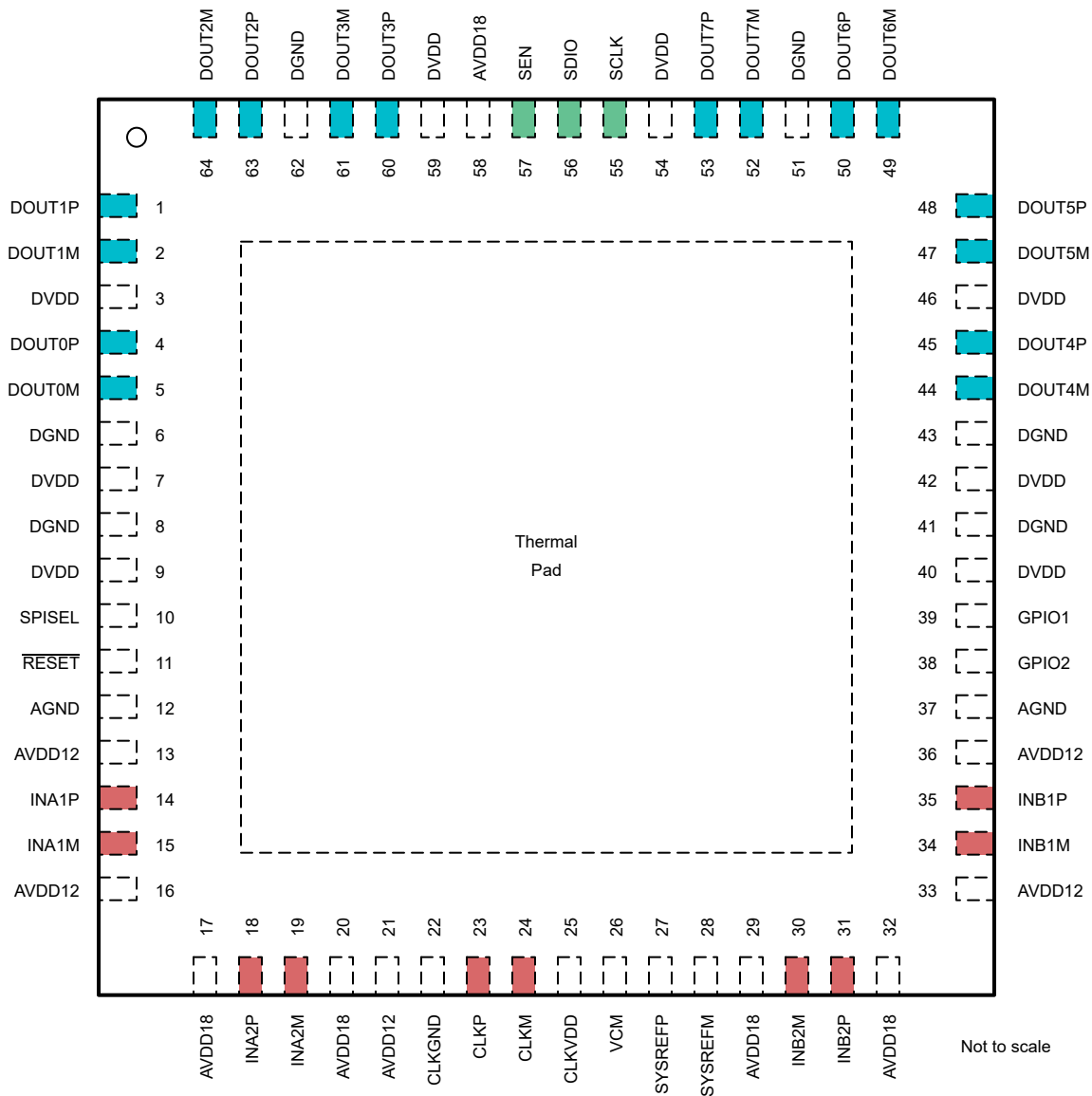

Figure 5-1. RTD Package, 64 Pin VQFN (Top View)

Table 5-1. Pin Functions

PIN		TYPE ⁽¹⁾	DESCRIPTION
NAME	NO.		
ANALOG INPUTS			
INA1P	14	I	Differential analog input for channel A. 100 Ω (default) or 50 Ω differential internal termination.
INA1M	15		
INA2P	18	I	Differential analog input for alternate channel A input. This input is used for additional ADC averaging for channel A. 100 Ω (default) or 50 Ω differential internal termination. Should be connected to GND if unused.
INA2M	19		

Table 5-1. Pin Functions (continued)

PIN		TYPE ⁽¹⁾	DESCRIPTION
NAME	NO.		
INB1P	35	I	Differential analog input for channel B. 100 Ω (default) or 50 Ω differential internal termination.
INB1M	34		
INB2P	31	I	Differential analog input for alternate channel B input. This input is used for additional ADC averaging for channel B. 100 Ω (default) or 50 Ω differential internal termination. Should be connected to GND if unused.
INB2M	30		
VCM	26	O	Common-mode voltage output for the analog inputs.
CLOCK, SYNCHRONIZATION			
CLKP	23	I	Differential sampling clock input. 100 Ω differential internal termination.
CLKM	24		
SYSREFP	27	I	Differential external synchronization input.
SYSREFM	28		
CONTROL			
RESET	11	I	Hardware reset. Active low. This pin has an internal 21 kΩ pullup resistor to AVDD18.
SEN	57	I	Serial interface enable. Active low. This pin has an internal 21 kΩ pull-up resistor to AVDD18.
SCLK	55	I	Serial interface clock input. This pin has an internal 21 kΩ pull-down resistor.
SDIO	56	I/O	Serial interface data input and output. This pin has an internal 21 kΩ pull-down resistor.
GPIO1	39	I	GPIO control pin. This pin is configured through SPI interface for power down or NCO control function.
GPIO2	38	I	GPIO control pin. This pin is configured through SPI interface for power down or NCO control function.
SPISEL	10	I	Determines SPI control: either normal SPI for register writes or fast access to NCO selection only for fast frequency hopping.
DIGITAL DATA INTERFACE			
DOUT0P	4	O	JESD204B high-speed serial data output interface pins for channel A.
DOUT0M	5		
DOUT1P	1		
DOUT1M	2		
DOUT2P	63		
DOUT2M	64		
DOUT3P	60		
DOUT3M	61		
DOUT4P	45	O	JESD204B high-speed serial data output interface pins for channel B.
DOUT4M	44		
DOUT5P	48		
DOUT5M	47		
DOUT6P	50		
DOUT6M	49		
DOUT7P	53		
DOUT7M	52		
POWER SUPPLY			
AVDD18	17,20,29,32, 58	I	Analog 1.8-V power supply
AVDD12	13,16,21,33, 36	I	Analog 1.2-V power supply
CLKVDD	25	I	Clock 1.2-V power supply. Very sensitive to power supply noise. Directly impacts close in aperture phase noise.
DVDD	3,7,9,40,42, 46,54,59	I	Digital 1.2-V power supply
AGND	12,37	I	Analog ground, shorted to thermal pad.
CLKGND	22	I	Clock ground.
DGND	6,8,41,43,51,62	I	Digital ground.

(1) I = Input, O = Output, I/O = Input or Output.

6 Specifications

6.1 Absolute Maximum Ratings

over operating free-air temperature range (unless otherwise noted)⁽¹⁾

PARAMETER	TEST CONDITIONS	MIN	MAX	UNIT
Supply voltage range, AVDD18		-0.3	2.1	V
Supply voltage range, AVDD12/CLKVDD/DVDD		-0.3	1.4	V
Voltage applied to input pins	INA1P/M, INB1P/M, INA2P/M, INB2P/M	-0.6	1.2	V
	CLKP/M	-0.3	VDDCLK + 0.3	
	SYSREFP/M	-0.3	AVDD12 + 0.6	
	GPIO1/2, PDN, RESET, SCLK, SEN, SDIO, SPISEL	-0.3	AVDD18 + 0.2	
Peak RF input power (INx1P/M, INx2P/M)	Differential 100 Ω termination.		12	dBm
Junction temperature, T _J			115	°C
Storage temperature, T _{stg}		-65	150	°C

- (1) Stresses beyond those listed under *Absolute Maximum Ratings* may cause permanent damage to the device. These are stress ratings only, which do not imply functional operation of the device at these or any other conditions beyond those indicated under *Recommended Operating Conditions*. Exposure to absolute-maximum-rated conditions for extended periods may affect device reliability.

6.2 ESD Ratings

			VALUE	UNIT
V _(ESD)	Electrostatic discharge	Human body model (HBM), per ANSI/ESDA/JEDEC JS-001 ⁽¹⁾	± 1000	V
		Charged device model (CDM), per ANSI/ESDA/JEDEC JS-002 ⁽²⁾	± 500	

- (1) JEDEC document JEP155 states that 500-V HBM allows safe manufacturing with a standard ESD control process.
 (2) JEDEC document JEP157 states that 250-V CDM allows safe manufacturing with a standard ESD control process.

6.3 Recommended Operating Conditions

over operating free-air temperature range (unless otherwise noted)

			MIN	NOM	MAX	UNIT
AVDD18	1.8 V analog supply		1.75	1.8	1.85	V
AVDD12	1.2 V analog supply		1.175	1.2	1.225	
CLKVDD	1.2 V clock supply		1.175	1.2	1.225	
DVDD	1.2 V digital supply		1.175	1.2	1.225	
T _A	Operating free-air temperature		-40		85	°C
T _J	Operating junction temperature				105 ⁽¹⁾	°C

- (1) Prolonged use above this junction temperature may increase the device failure-in-time (FIT) rate.

6.4 Thermal Information

THERMAL METRIC ⁽¹⁾		ADC32RF5x	UNIT
		RTD (QFN)	
		64 Pins	
$R_{\theta JA}$	Junction-to-ambient thermal resistance	20.1	°C/W
$R_{\theta JC(top)}$	Junction-to-case (top) thermal resistance	6.8	°C/W
$R_{\theta JB}$	Junction-to-board thermal resistance	5.2	°C/W
Ψ_{JT}	Junction-to-top characterization parameter	0.1	°C/W
Ψ_{JB}	Junction-to-board characterization parameter	5.1	°C/W
$R_{\theta JC(bot)}$	Junction-to-case (bottom) thermal resistance	0.5	°C/W

(1) For more information about thermal metrics, see the *Semiconductor and IC Package Thermal Metrics* application report, SPRA953.

6.5 Electrical Characteristics - Power Consumption

Maximum and minimum values are specified over the operating free-air temperature range and nominal supply voltages. Typical values are specified at $T_A = 25^\circ\text{C}$, ADC sampling rate = 3.0 GSPS, Bypass mode, 50% clock duty cycle, AVDD18 = 1.8 V, AVDD12, AVDDCLK, DVDD = 1.2 V and –1-dBFS differential input, unless otherwise noted

PARAMETER		TEST CONDITIONS	MIN	TYP	MAX	UNIT
FS = 3.0 GSPS						
I _{AVDD18}	Supply current, 1.8 V analog supply	Bypass mode, 12-bit output, LMFS = 82820		275		mA
I _{AVDD12}	Supply current, 1.2 V analog supply			930		
I _{CLKVDD}	Supply current, 1.2 V clock supply			125		
I _{DVDD}	Supply current, 1.2 V digital supply			2050		
P _{DIS}	Power dissipation			4.2		W
I _{AVDD18}	Supply current, 1.8 V analog supply	2x averaging, LMFS = 82820		370		mA
I _{AVDD12}	Supply current, 1.2 V analog supply			1270		
I _{CLKVDD}	Supply current, 1.2 V clock supply			130		
I _{DVDD}	Supply current, 1.2 V digital supply			2440		
P _{DIS}	Power dissipation			5.25		W
I _{AVDD18}	Supply current, 1.8 V analog supply	4x averaging, LMFS = 82820		560	620	mA
I _{AVDD12}	Supply current, 1.2 V analog supply			1920	2120	
I _{CLKVDD}	Supply current, 1.2 V clock supply			150	175	
I _{DVDD}	Supply current, 1.2 V digital supply			3020	3600	
P _{DIS}	Power dissipation			7.1		W
FS = 2.6 GSPS						
I _{AVDD18}	Supply current, 1.8 V analog supply	Bypass mode, LMFS = 8224		230	TBD	mA
I _{AVDD12}	Supply current, 1.2 V analog supply			770	TBD	
I _{CLKVDD}	Supply current, 1.2 V clock supply			120	TBD	
I _{DVDD}	Supply current, 1.2 V digital supply			1550	TBD	
P _{DIS}	Power dissipation			3.4	TBD	W
I _{AVDD18}	Supply current, 1.8 V analog supply	2x averaging, LMFS = 8224		320		mA
I _{AVDD12}	Supply current, 1.2 V analog supply			1050		
I _{CLKVDD}	Supply current, 1.2 V clock supply			130		
I _{DVDD}	Supply current, 1.2 V digital supply			1700		
P _{DIS}	Power dissipation			4.1		W
I _{AVDD18}	Supply current, 1.8 V analog supply	4x averaging, LMFS = 8224		490		mA
I _{AVDD12}	Supply current, 1.2 V analog supply			1600		
I _{CLKVDD}	Supply current, 1.2 V clock supply			150		
I _{DVDD}	Supply current, 1.2 V digital supply			2100		
P _{DIS}	Power dissipation			5.5		W
POWER DOWN MODES						
P _{DIS}	Power down mode power consumption			190		mW

6.6 Electrical Characteristics - DC Specifications

Maximum and minimum values are specified over the operating free-air temperature range and nominal supply voltages. Typical values are specified at $T_A = 25^\circ\text{C}$, ADC sampling rate = 3.0 GSPS, Bypass mode, 50% clock duty cycle, AVDD18 = 1.8 V, AVDD12, AVDDCLK, DVDD = 1.2 V and -1-dBFS differential input, unless otherwise noted

PARAMETER		TEST CONDITIONS	MIN	TYP	MAX	UNIT	
DC ACCURACY: ADC32RF55							
DNL	Differential nonlinearity	$F_{IN} = 10\text{ MHz}$		± 0.85		LSB	
INL	Integral nonlinearity	$F_{IN} = 10\text{ MHz}$		± 4		LSB	
V _{OS_ERR}	Offset error			± 0.2		%FSR	
GAIN _{ERR}	Gain error			± 0.2		%FSR	
GAIN _{Match}	Gain matching across channels			± 0.2		dB	
DC ACCURACY: ADC32RF54							
DNL	Differential nonlinearity	$F_{IN} = 10\text{ MHz}$		± 0.85		LSB	
INL	Integral nonlinearity	$F_{IN} = 10\text{ MHz}$		± 4		LSB	
V _{OS_ERR}	Offset error			± 0.2		%FSR	
GAIN _{ERR}	Gain error			± 0.2		%FSR	
GAIN _{Match}	Gain matching across channels			± 0.2		dB	
ADC ANALOG INPUTS (INA1P/M, INB1P/M, INA2P/M, INB2P/M)							
FS	Input full scale	Differential, non-average mode		1.1		V _{pp}	
	Input full scale	Differential, 2x or 4x average mode		1.35			
V _{ICM}	Input common mode voltage		250	350	450	mV	
Z _{IN}	Differential input impedance	Differential at 100 MHz		100		Ω	
V _{OCM}	Output common mode voltage			350		mV	
BW	Analog Input Bandwidth (-3 dB)	1x, 2x AVG, RSW=1		2.75		GHz	
		4x AVG, RSW=1		2.1			
Phase imbalance, analog input				± 2		deg	
Amplitude imbalance, analog input				± 0.5		dB	
CMRR	Common mode rejection ratio	$F_{IN} = 100\text{ MHz}$		25		dB	
CLOCK INPUT (CLKP/M)							
Input clock frequency		ADC32RF54		500	2600	MHz	
		ADC32RF55		500	3000	MHz	
V _{ID}	Differential input voltage			1	2.4	V _{pp}	
V _{ICM}	Input common mode voltage		0.65	0.75	0.85	V	
Z _{IN}	Differential input impedance	Differential at 2.6 GHz		100		Ω	
Clock duty cycle				45	50	55	%
SYSREF INPUT (SYSREFP/M)							
V _{ID}	Differential input voltage		600	800	1000	mV _{pp}	
V _{ICM}	Input common mode voltage	Input common mode voltage	1.05	1.2	1.4	V	
Z _{IN}	Differential input impedance			100		Ω	
DIGITAL INPUTS (RESET, PDN, SCLK, SEN, SDIO, GPIO1/2, SPISEL)							
V _{IH}	High-level input voltage		0.8			V	
V _{IL}	Low-level input voltage				0.4	V	
C _I	Input capacitance			0.6		pF	
DIGITAL OUTPUT (SDIO)							
V _{OH}	High-level output voltage	I _{LOAD} = -400 μA	AVDD18 - 0.1	AVDD18		V	
V _{OL}	Low-level output voltage	I _{LOAD} = 400 μA			0.1	V	

6.6 Electrical Characteristics - DC Specifications (continued)

Maximum and minimum values are specified over the operating free-air temperature range and nominal supply voltages. Typical values are specified at $T_A = 25^\circ\text{C}$, ADC sampling rate = 3.0 GSPS, Bypass mode, 50% clock duty cycle, AVDD18 = 1.8 V, AVDD12, AVDDCLK, DVDD = 1.2 V and –1-dBFS differential input, unless otherwise noted

PARAMETER		TEST CONDITIONS	MIN	TYP	MAX	UNIT
CML SERDES OUTPUTS: DOUT[0:7]P/M						
V_{OD}	Serdes transmitter output amplitude	differential peak-peak		700		mVpp
V_{OCM}	Serdes transmitter output common mode			425		mV
Z_{TX}	Serdes transmitter single ended termination impedance			50		Ω
	Transmitter short-circuit current	Transmitter pins shorted to any voltage between –0.25 V and 1.45 V	–100		100	mA

6.7 Electrical Characteristics - ADC32RF54 AC Specifications (Dither DISABLED)

Maximum and minimum values are specified over the operating free-air temperature range and nominal supply voltages. Typical values are specified at $T_A = 25^\circ\text{C}$, ADC sampling rate = 2.6 GSPS, Bypass mode, 50% clock duty cycle, AVDD18 = 1.8 V, AVDD12, AVDDCLK, DVDD = 1.2 V, -1-dBFS differential input and dither DISABLED, unless otherwise noted

PARAMETER		TEST CONDITIONS	MIN	TYP	MAX	UNIT
NSD	Noise Spectral Density	$f_{IN} = 900\text{ MHz}$, $A_{IN} = -20\text{ dBFS}$ no averaging		-155.5		dBFS/Hz
		$f_{IN} = 900\text{ MHz}$, $A_{IN} = -20\text{ dBFS}$ 2x averaging		-158.2		
		$f_{IN} = 900\text{ MHz}$, $A_{IN} = -20\text{ dBFS}$ 4x averaging		-161.2		
NF	Noise Figure	$f_{IN} = 900\text{ MHz}$, $A_{IN} = -20\text{ dBFS}$ no averaging		20.3		dB
		$f_{IN} = 900\text{ MHz}$, $A_{IN} = -20\text{ dBFS}$ 2x averaging		19.3		
		$f_{IN} = 900\text{ MHz}$, $A_{IN} = -20\text{ dBFS}$ 4x averaging		19.7		
SNR	Signal-to-noise ratio no averaging	$f_{IN} = 100\text{ MHz}$		61.9		dBFS
		$f_{IN} = 500\text{ MHz}$		61.9		
		$f_{IN} = 900\text{ MHz}$		61.7		
		$f_{IN} = 900\text{ MHz}$, $A_{in} = -20\text{ dBFS}$		64.4		
		$f_{IN} = 1.8\text{ GHz}$		60.6		
		$f_{IN} = 2.4\text{ GHz}$		60.0		
	Signal-to-noise ratio 2x averaging	$f_{IN} = 100\text{ MHz}$		62.8		
		$f_{IN} = 500\text{ MHz}$		63.2		
		$f_{IN} = 900\text{ MHz}$		62.8		
		$f_{IN} = 900\text{ MHz}$, $A_{in} = -20\text{ dBFS}$		67.1		
		$f_{IN} = 1.8\text{ GHz}$		62.5		
		$f_{IN} = 2.4\text{ GHz}$		61.8		
	Signal-to-noise ratio 4x averaging	$f_{IN} = 100\text{ MHz}$		65.5		
		$f_{IN} = 500\text{ MHz}$		65.9		
		$f_{IN} = 900\text{ MHz}$		65.6		
		$f_{IN} = 900\text{ MHz}$, $A_{in} = -20\text{ dBFS}$		69.8		
		$f_{IN} = 1.8\text{ GHz}$		65.4		
		$f_{IN} = 2.4\text{ GHz}$		64.9		
SINAD	Signal to noise and distortion ratio	$f_{IN} = 100\text{ MHz}$		61.4		dBFS
		$f_{IN} = 500\text{ MHz}$		60.2		
		$f_{IN} = 900\text{ MHz}$	TBD	59.4		
		$f_{IN} = 1.8\text{ GHz}$		57.6		
		$f_{IN} = 2.4\text{ GHz}$		55.3		
ENOB	Effective number of bits	$f_{IN} = 100\text{ MHz}$		9.9		Bits
		$f_{IN} = 500\text{ MHz}$		9.7		
		$f_{IN} = 900\text{ MHz}$	TBD	9.6		
		$f_{IN} = 1.8\text{ GHz}$		9.3		
		$f_{IN} = 2.4\text{ GHz}$		8.9		

6.7 Electrical Characteristics - ADC32RF54 AC Specifications (Dither DISABLED) (continued)

Maximum and minimum values are specified over the operating free-air temperature range and nominal supply voltages. Typical values are specified at $T_A = 25^\circ\text{C}$, ADC sampling rate = 2.6 GSPS, Bypass mode, 50% clock duty cycle, AVDD18 = 1.8 V, AVDD12, AVDDCLK, DVDD = 1.2 V, -1-dBFS differential input and dither DISABLED, unless otherwise noted

PARAMETER		TEST CONDITIONS	MIN	TYP	MAX	UNIT
THD	Total Harmonic Distortion (First five harmonics)	$f_{IN} = 100\text{ MHz}$		67		dBc
		$f_{IN} = 500\text{ MHz}$		63		
		$f_{IN} = 900\text{ MHz}$	TBD	64		
		$f_{IN} = 1.8\text{ GHz}$		60		
		$f_{IN} = 2.4\text{ GHz}$		57		
HD2	Second Harmonic Distortion	$f_{IN} = 100\text{ MHz}$		72		dBc
		$f_{IN} = 500\text{ MHz}$		73		
		$f_{IN} = 900\text{ MHz}$	TBD	71		
		$f_{IN} = 1.8\text{ GHz}$		62		
		$f_{IN} = 2.4\text{ GHz}$		59		
HD3	Third Harmonic Distortion	$f_{IN} = 100\text{ MHz}$		75		dBc
		$f_{IN} = 500\text{ MHz}$		65		
		$f_{IN} = 900\text{ MHz}$	TBD	67		
		$f_{IN} = 1.8\text{ GHz}$		66		
		$f_{IN} = 2.4\text{ GHz}$		64		
Non HD2,3	Spur free dynamic range (excluding HD2 and HD3)	$f_{IN} = 100\text{ MHz}$		76		dBFS
		$f_{IN} = 500\text{ MHz}$		74		
		$f_{IN} = 900\text{ MHz}$	TBD	77		
		$f_{IN} = 1.8\text{ GHz}$		77		
		$f_{IN} = 2.4\text{ GHz}$		74		
IMD3	Two tone inter-modulation distortion	$f_1 = 700\text{ MHz}, f_2 = 800\text{ MHz}, A_{IN} = -7\text{ dBFS/tone}$		71		dBc
		$f_1 = 1.5\text{ GHz}, f_2 = 1.6\text{ GHz}, A_{IN} = -7\text{ dBFS/tone}$		68		

6.8 Electrical Characteristics - ADC32RF54 AC Specifications (Dither ENABLED)

Maximum and minimum values are specified over the operating free-air temperature range and nominal supply voltages. Typical values are specified at $T_A = 25^\circ\text{C}$, ADC sampling rate = 2.6 GSPS, Bypass mode, 50% clock duty cycle, AVDD18 = 1.8 V, AVDD12, AVDDCLK, DVDD = 1.2 V, -4-dBFS differential input and dither ENABLED, unless otherwise noted

PARAMETER		TEST CONDITIONS	MIN	TYP	MAX	UNIT
NSD ⁽¹⁾	Noise Spectral Density	$f_{IN} = 900\text{ MHz}$, $A_{IN} = -20\text{ dBFS}$ no averaging		-155.6		dBFS/Hz
		$f_{IN} = 900\text{ MHz}$, $A_{IN} = -20\text{ dBFS}$ 2x averaging		-158.0		
		$f_{IN} = 900\text{ MHz}$, $A_{IN} = -20\text{ dBFS}$ 4x averaging		-160.7		
NF ⁽¹⁾	Noise Figure	$f_{IN} = 900\text{ MHz}$, $A_{IN} = -20\text{ dBFS}$ no averaging		20.2		dB
		$f_{IN} = 900\text{ MHz}$, $A_{IN} = -20\text{ dBFS}$ 2x averaging		19.5		
		$f_{IN} = 900\text{ MHz}$, $A_{IN} = -20\text{ dBFS}$ 4x averaging		19.9		
SNR ⁽¹⁾	Signal-to-noise ratio no averaging	$f_{IN} = 100\text{ MHz}$		62.4		dBFS
		$f_{IN} = 500\text{ MHz}$		62.2		
		$f_{IN} = 900\text{ MHz}$		62.7		
		$f_{IN} = 900\text{ MHz}$, $A_{in} = -20\text{ dBFS}$		64.5		
		$f_{IN} = 1.8\text{ GHz}$	TBD	62.0		
		$f_{IN} = 2.4\text{ GHz}$		61.5		
	Signal-to-noise ratio 2x averaging	$f_{IN} = 100\text{ MHz}$		64.1		
		$f_{IN} = 500\text{ MHz}$		64.3		
		$f_{IN} = 900\text{ MHz}$		64.2		
		$f_{IN} = 900\text{ MHz}$, $A_{in} = -20\text{ dBFS}$		66.9		
		$f_{IN} = 1.8\text{ GHz}$		63.9		
		$f_{IN} = 2.4\text{ GHz}$		63.3		
	Signal-to-noise ratio 4x averaging	$f_{IN} = 100\text{ MHz}$		67.2		
		$f_{IN} = 500\text{ MHz}$		67.7		
		$f_{IN} = 900\text{ MHz}$		67.3		
		$f_{IN} = 900\text{ MHz}$, $A_{in} = -20\text{ dBFS}$		69.6		
		$f_{IN} = 1.8\text{ GHz}$		67.0		
		$f_{IN} = 2.4\text{ GHz}$		66.8		
SINAD ⁽¹⁾	Signal to noise and distortion ratio	$f_{IN} = 100\text{ MHz}$		62.1		dBFS
		$f_{IN} = 500\text{ MHz}$		61.9		
		$f_{IN} = 900\text{ MHz}$		62.2		
		$f_{IN} = 1.8\text{ GHz}$	TBD	60.5		
		$f_{IN} = 2.4\text{ GHz}$		59.3		
ENOB ⁽¹⁾	Effective number of bits	$f_{IN} = 100\text{ MHz}$		10.0		Bits
		$f_{IN} = 500\text{ MHz}$		10.0		
		$f_{IN} = 900\text{ MHz}$		10.0		
		$f_{IN} = 1.8\text{ GHz}$	TBD	9.8		
		$f_{IN} = 2.4\text{ GHz}$		9.6		
THD	Total Harmonic Distortion (First five harmonics)	$f_{IN} = 100\text{ MHz}$		71		dBc
		$f_{IN} = 500\text{ MHz}$		70		
		$f_{IN} = 900\text{ MHz}$		68		
		$f_{IN} = 1.8\text{ GHz}$	TBD	63		
		$f_{IN} = 2.4\text{ GHz}$		61		

Maximum and minimum values are specified over the operating free-air temperature range and nominal supply voltages. Typical values are specified at $T_A = 25^\circ\text{C}$, ADC sampling rate = 2.6 GSPS, Bypass mode, 50% clock duty cycle, AVDD18 = 1.8 V, AVDD12, AVDDCLK, DVDD = 1.2 V, -4-dBFS differential input and dither ENABLED, unless otherwise noted

PARAMETER		TEST CONDITIONS	MIN	TYP	MAX	UNIT
HD2	Second Harmonic Distortion	$f_{IN} = 100 \text{ MHz}$		74		dBc
		$f_{IN} = 500 \text{ MHz}$		76		
		$f_{IN} = 900 \text{ MHz}$		74		
		$f_{IN} = 1.8 \text{ GHz}$	TBD	65		
		$f_{IN} = 2.4 \text{ GHz}$		62		
HD3	Third Harmonic Distortion	$f_{IN} = 100 \text{ MHz}$		76		dBc
		$f_{IN} = 500 \text{ MHz}$		72		
		$f_{IN} = 900 \text{ MHz}$		76		
		$f_{IN} = 1.8 \text{ GHz}$	TBD	72		
		$f_{IN} = 2.4 \text{ GHz}$		72		
Non HD2,3	Spur free dynamic range (excluding HD2 and HD3)	$f_{IN} = 100 \text{ MHz}$		88		dBFS
		$f_{IN} = 500 \text{ MHz}$		89		
		$f_{IN} = 900 \text{ MHz}$		78		
		$f_{IN} = 1.8 \text{ GHz}$	TBD	79		
		$f_{IN} = 2.4 \text{ GHz}$		87		
IMD3	Two tone inter-modulation distortion	$f_1 = 700 \text{ MHz}, f_2 = 800 \text{ MHz}, A_{IN} = -10 \text{ dBFS/ tone}$		71		dBc
		$f_1 = 1.5 \text{ GHz}, f_2 = 1.6 \text{ GHz}, A_{IN} = -10 \text{ dBFS/ tone}$		75		

(1) Measured from 100 MHz to Nyquist ($F_S/2$) excluding dither

6.9 Electrical Characteristics - ADC32RF55 AC Specifications (Dither DISABLED)

Maximum and minimum values are specified over the operating free-air temperature range and nominal supply voltages. Typical values are specified at $T_A = 25^\circ\text{C}$, ADC sampling rate = 3.0 GSPS, Bypass mode, 50% clock duty cycle, AVDD18 = 1.8 V, AVDD12, AVDDCLK, DVDD = 1.2 V, -1-dBFS differential input and dither DISABLED, unless otherwise noted

PARAMETER		TEST CONDITIONS	MIN	TYP	MAX	UNIT
NSD	Noise Spectral Density	$f_{IN} = 900\text{ MHz}$, $A_{IN} = -20\text{ dBFS}$ no averaging		-155.6		dBFS/Hz
		$f_{IN} = 900\text{ MHz}$, $A_{IN} = -20\text{ dBFS}$ 2x averaging		-158.1		
		$f_{IN} = 900\text{ MHz}$, $A_{IN} = -20\text{ dBFS}$ 4x averaging		-160.4		
NF	Noise Figure	$f_{IN} = 900\text{ MHz}$, $A_{IN} = -20\text{ dBFS}$ no averaging		20.2		dB
		$f_{IN} = 900\text{ MHz}$, $A_{IN} = -20\text{ dBFS}$ 2x averaging		19.8		
		$f_{IN} = 900\text{ MHz}$, $A_{IN} = -20\text{ dBFS}$ 4x averaging		17.5		
SNR	Signal-to-noise ratio no averaging	$f_{IN} = 100\text{ MHz}$		62.1		dBFS
		$f_{IN} = 500\text{ MHz}$		61.8		
		$f_{IN} = 900\text{ MHz}$		61.7		
		$f_{IN} = 900\text{ MHz}$, $A_{in} = -20\text{ dBFS}$		63.8		
		$f_{IN} = 1.8\text{ GHz}$		61.1		
		$f_{IN} = 2.4\text{ GHz}$		60.2		
	Signal-to-noise ratio 2x averaging	$f_{IN} = 100\text{ MHz}$		63.6		
		$f_{IN} = 500\text{ MHz}$		63.3		
		$f_{IN} = 900\text{ MHz}$		63.5		
		$f_{IN} = 900\text{ MHz}$, $A_{in} = -20\text{ dBFS}$		66.3		
		$f_{IN} = 1.8\text{ GHz}$		62.7		
		$f_{IN} = 2.4\text{ GHz}$		62.4		
	Signal-to-noise ratio 4x averaging	$f_{IN} = 100\text{ MHz}$		66.7		
		$f_{IN} = 500\text{ MHz}$		65.0		
		$f_{IN} = 900\text{ MHz}$		65.7		
		$f_{IN} = 900\text{ MHz}$, $A_{in} = -20\text{ dBFS}$		68.6		
		$f_{IN} = 1.8\text{ GHz}$		64.7		
		$f_{IN} = 2.4\text{ GHz}$		64.5		
SINAD	Signal to noise and distortion ratio	$f_{IN} = 100\text{ MHz}$		58.2		dBFS
		$f_{IN} = 500\text{ MHz}$		57.9		
		$f_{IN} = 900\text{ MHz}$		55.8		
		$f_{IN} = 1.8\text{ GHz}$		58.2		
		$f_{IN} = 2.4\text{ GHz}$		54.8		
ENOB	Effective number of bits	$f_{IN} = 100\text{ MHz}$		10.0		Bits
		$f_{IN} = 500\text{ MHz}$		10.0		
		$f_{IN} = 900\text{ MHz}$		10.0		
		$f_{IN} = 1.8\text{ GHz}$		9.9		
		$f_{IN} = 2.4\text{ GHz}$		9.7		
THD	Total Harmonic Distortion (First five harmonics)	$f_{IN} = 100\text{ MHz}$		61		dBc
		$f_{IN} = 500\text{ MHz}$		60		
		$f_{IN} = 900\text{ MHz}$		57		
		$f_{IN} = 1.8\text{ GHz}$		63		
		$f_{IN} = 2.4\text{ GHz}$		57		

Maximum and minimum values are specified over the operating free-air temperature range and nominal supply voltages. Typical values are specified at $T_A = 25^\circ\text{C}$, ADC sampling rate = 3.0 GSPS, Bypass mode, 50% clock duty cycle, AVDD18 = 1.8 V, AVDD12, AVDDCLK, DVDD = 1.2 V, -1-dBFS differential input and dither DISABLED, unless otherwise noted

PARAMETER		TEST CONDITIONS	MIN	TYP	MAX	UNIT
HD2	Second Harmonic Distortion	$f_{IN} = 100 \text{ MHz}$		61		dBc
		$f_{IN} = 500 \text{ MHz}$		66		
		$f_{IN} = 900 \text{ MHz}$		68		
		$f_{IN} = 1.8 \text{ GHz}$		66		
		$f_{IN} = 2.4 \text{ GHz}$		57		
HD3	Third Harmonic Distortion	$f_{IN} = 100 \text{ MHz}$		66		dBc
		$f_{IN} = 500 \text{ MHz}$		62		
		$f_{IN} = 900 \text{ MHz}$		57		
		$f_{IN} = 1.8 \text{ GHz}$		65		
		$f_{IN} = 2.4 \text{ GHz}$		64		
Non HD2,3	Spur free dynamic range (excluding HD2 and HD3)	$f_{IN} = 100 \text{ MHz}$		78		dBFS
		$f_{IN} = 500 \text{ MHz}$		75		
		$f_{IN} = 900 \text{ MHz}$		78		
		$f_{IN} = 1.8 \text{ GHz}$		76		
		$f_{IN} = 2.4 \text{ GHz}$		75		
IMD3	Two tone inter-modulation distortion	$f_1 = 700 \text{ MHz}, f_2 = 800 \text{ MHz}, A_{IN} = -7 \text{ dBFS/ tone}$		72		dBFS
		$f_1 = 1.5 \text{ GHz}, f_2 = 1.6 \text{ GHz}, A_{IN} = -7 \text{ dBFS/ tone}$		66		

6.10 Electrical Characteristics - ADC32RF55 AC Specifications (Dither ENABLED)

Maximum and minimum values are specified over the operating free-air temperature range and nominal supply voltages. Typical values are specified at $T_A = 25^\circ\text{C}$, ADC sampling rate = 3.0 GSPS, Bypass mode, 50% clock duty cycle, AVDD18 = 1.8 V, AVDD12, AVDDCLK, DVDD = 1.2 V, -4-dBFS differential input and dither ENABLED, unless otherwise noted

PARAMETER		TEST CONDITIONS	MIN ⁽²⁾	TYP	MAX	UNIT
NSD ⁽¹⁾	Noise Spectral Density	$f_{IN} = 900\text{ MHz}$, $A_{IN} = -20\text{ dBFS}$ no averaging		-155.1		dBFS/Hz
		$f_{IN} = 900\text{ MHz}$, $A_{IN} = -20\text{ dBFS}$ 2x averaging		-157.3		
		$f_{IN} = 900\text{ MHz}$, $A_{IN} = -20\text{ dBFS}$ 4x averaging		-159.8		
NF ⁽¹⁾	Noise Figure	$f_{IN} = 900\text{ MHz}$, $A_{IN} = -20\text{ dBFS}$ no averaging		20.7		dB
		$f_{IN} = 900\text{ MHz}$, $A_{IN} = -20\text{ dBFS}$ 2x averaging		20.6		
		$f_{IN} = 900\text{ MHz}$, $A_{IN} = -20\text{ dBFS}$ 4x averaging		18.1		
SNR ⁽¹⁾	Signal-to-noise ratio no averaging	$f_{IN} = 100\text{ MHz}$		61.7		dBFS
		$f_{IN} = 500\text{ MHz}$		61.8		
		$f_{IN} = 900\text{ MHz}$	58.9	60.9		
		$f_{IN} = 900\text{ MHz}$, $A_{in} = -20\text{ dBFS}$	62.0	63.3		
		$f_{IN} = 1.8\text{ GHz}$		61.4		
		$f_{IN} = 2.4\text{ GHz}$		61.2		
	Signal-to-noise ratio 2x averaging	$f_{IN} = 100\text{ MHz}$		63.1		
		$f_{IN} = 500\text{ MHz}$		63.4		
		$f_{IN} = 900\text{ MHz}$		62.3		
		$f_{IN} = 900\text{ MHz}$, $A_{in} = -20\text{ dBFS}$		65.5		
		$f_{IN} = 1.8\text{ GHz}$		63.0		
		$f_{IN} = 2.4\text{ GHz}$		63.1		
	Signal-to-noise ratio 4x averaging	$f_{IN} = 100\text{ MHz}$		66.7		
		$f_{IN} = 500\text{ MHz}$		66.2		
		$f_{IN} = 900\text{ MHz}$	64.9	66.1		
		$f_{IN} = 900\text{ MHz}$, $A_{in} = -20\text{ dBFS}$	67.1	68.0		
		$f_{IN} = 1.8\text{ GHz}$		65.5		
		$f_{IN} = 2.4\text{ GHz}$		65.4		
SINAD ⁽¹⁾	Signal to noise and distortion ratio	$f_{IN} = 100\text{ MHz}$		60.5		dBFS
		$f_{IN} = 500\text{ MHz}$		60.8		
		$f_{IN} = 900\text{ MHz}$		59.5		
		$f_{IN} = 1.8\text{ GHz}$		60.3		
		$f_{IN} = 2.4\text{ GHz}$		58.6		
ENOB ⁽¹⁾	Effective number of bits	$f_{IN} = 100\text{ MHz}$		10.0		Bits
		$f_{IN} = 500\text{ MHz}$		10.0		
		$f_{IN} = 900\text{ MHz}$		9.8		
		$f_{IN} = 1.8\text{ GHz}$		9.9		
		$f_{IN} = 2.4\text{ GHz}$		9.7		
THD ⁽¹⁾	Total Harmonic Distortion (First five harmonics)	$f_{IN} = 100\text{ MHz}$		67		dBc
		$f_{IN} = 500\text{ MHz}$		68		
		$f_{IN} = 900\text{ MHz}$		65		
		$f_{IN} = 1.8\text{ GHz}$		69		
		$f_{IN} = 2.4\text{ GHz}$		64		

Maximum and minimum values are specified over the operating free-air temperature range and nominal supply voltages. Typical values are specified at $T_A = 25^\circ\text{C}$, ADC sampling rate = 3.0 GSPS, Bypass mode, 50% clock duty cycle, AVDD18 = 1.8 V, AVDD12, AVDDCLK, DVDD = 1.2 V, -4-dBFS differential input and dither ENABLED, unless otherwise noted

PARAMETER		TEST CONDITIONS	MIN ⁽²⁾	TYP	MAX	UNIT
HD2 ⁽¹⁾	Second Harmonic Distortion	$f_{IN} = 100 \text{ MHz}$		64		dBc
		$f_{IN} = 500 \text{ MHz}$		69		
		$f_{IN} = 900 \text{ MHz}$	61	68		
		$f_{IN} = 1.8 \text{ GHz}$		68		
		$f_{IN} = 2.4 \text{ GHz}$		60		
HD3 ⁽¹⁾	Third Harmonic Distortion	$f_{IN} = 100 \text{ MHz}$		71		dBc
		$f_{IN} = 500 \text{ MHz}$		67		
		$f_{IN} = 900 \text{ MHz}$	60	63		
		$f_{IN} = 1.8 \text{ GHz}$		68		
		$f_{IN} = 2.4 \text{ GHz}$		72		
Non HD2,3 ⁽¹⁾	Spur free dynamic range (excluding HD2 and HD3)	$f_{IN} = 100 \text{ MHz}$		91		dBFS
		$f_{IN} = 500 \text{ MHz}$		89		
		$f_{IN} = 900 \text{ MHz}$	78	85		
		$f_{IN} = 1.8 \text{ GHz}$		86		
		$f_{IN} = 2.4 \text{ GHz}$		86		
IMD3	Two tone inter-modulation distortion	$f_1 = 700 \text{ MHz}, f_2 = 800 \text{ MHz}, A_{IN} = -10 \text{ dBFS/tone}$	73	80		dBFS
		$f_1 = 1.5 \text{ GHz}, f_2 = 1.6 \text{ GHz}, A_{IN} = -10 \text{ dBFS/tone}$		75		

(1) Measured from 100 MHz to Nyquist ($F_S/2$) excluding dither

(2) SNR, IMD3 minimum values are specified by ATE, HD2, HD3 and Non HD23 are specified by bench characterization.

6.11 Timing Requirements

Maximum and minimum values are specified over the operating free-air temperature range and nominal supply voltages. Typical values are specified at $T_A = 25^\circ\text{C}$, ADC sampling rate = 3.0 GSPS, Bypass mode, 50% clock duty cycle, AVDD18 = 1.8V, AVDD12, AVDDCLK, DVDD = 1.2V and –1-dBFS differential input, unless otherwise noted

PARAMETER		TEST CONDITIONS	MIN	TYP	MAX	UNIT	
ADC TIMING SPECIFICATIONS							
T_{AD}	Aperture Delay			0.17		ns	
	Aperture Delay variation			0.07		ns	
T_A	Aperture Jitter			50		fs	
Overload recovery time		3-dB overload condition		10		clock cycles	
		6-dB overload condition		50			
t_{ADC}	ADC latency from sampling instant to internal hand-off to digital			68		clock cycles	
	Internal propagation delay			5		ns	
	Latency adder for 2x or 4x averaging			4		clock cycles	
	Deterministic delay from digital block (DDC (if used) and JESD interface)	LMFS = 8-2-8-20			260		clock cycles
		LMFS = 8-2-2-4			280		
		4x complex decimation, LMFS = 8-4-2-2			456		
		4x real decimation, LMFS = 4-2-2-2			456		
		4x decimation, F (number of octets) = 2			394		
		4x decimation, F = 4			374		
		4x decimation, F = 8			367		
		8x decimation, F = 2			560		
		8x decimation, F = 4			520		
		8x decimation, F = 8			506		
		8x decimation, F = 16			491		
		16x decimation, F = 2			900		
		16x decimation, F = 4			820		
		16x decimation, F = 8			792		
		16x decimation, F = 16			762		
		16x decimation, F = 32			748		
		32x decimation, F = 2			1596		
		32x decimation, F = 4			1436		
		32x decimation, F = 8			1380		
		32x decimation, F = 16			1320		
		32x decimation, F = 32			1292		
		64x decimation, F = 2			2940		
		64x decimation, F = 4			2620		
		64x decimation, F = 8			2508		
		64x decimation, F = 16			2388		
64x decimation, F = 32				2332			
128x decimation, F = 2			5668				
128x decimation, F = 4			5028				
128x decimation, F = 8			4804				
128x decimation, F = 16			4564				
128x decimation, F = 32			4452				

Maximum and minimum values are specified over the operating free-air temperature range and nominal supply voltages. Typical values are specified at $T_A = 25^\circ\text{C}$, ADC sampling rate = 3.0 GSPS, Bypass mode, 50% clock duty cycle, AVDD18 = 1.8V, AVDD12, AVDDCLK, DVDD = 1.2V and –1-dBFS differential input, unless otherwise noted

PARAMETER		TEST CONDITIONS	MIN	TYP	MAX	UNIT
SERIAL PROGRAMMING INTERFACE (SCLK, SEN, SDIO) - Input						
$f_{\text{CLK(SCLK)}}$	Serial clock frequency		1		20	MHz
$t_{\text{SU(SEN)}}$	SEN to rising edge of SCLK		10			ns
$t_{\text{H(SEN)}}$	SEN from rising edge of SCLK		10			ns
$t_{\text{SU(SDIO)}}$	SDIO to rising edge of SCLK		10			ns
$t_{\text{H(SDIO)}}$	SDIO from rising edge of SCLK		10			ns
SERIAL PROGRAMMING INTERFACE (SDIO) - Output						
$t_{\text{(OZD)}}$	SDIO tri-state to driven				10	ns
$t_{\text{(ODZ)}}$	SDIO data to tri-state				14	ns
$t_{\text{(OD)}}$	SDIO valid from falling edge of SCLK				10	ns
TIMING: SYSREFP/M						
$t_{\text{s(SYSREF)}}$	Setup time, SYSREFP/M valid to rising edge of CLKP/M		50			ps
$t_{\text{h(SYSREF)}}$	Hold time, SYSREFP/M valid to rising edge of CLKP/M		50			ps
CML SERDES OUTPUTS: DA[0:3]P/M, DB[0:3]P/M						
f_{Serdes}	Serdes bit rate		0.5	12.8	13.0	Gbps
R_J	Random jitter, RMS	RPAT, 6.4 Gbps	0.7			ps
		RPAT, 12.8 Gbps	0.6			
D_J	Deterministic jitter, peak to peak	RPAT, 6.4 Gbps	8.9			ps
		RPAT, 12.8 Gbps	14.7			
T_J	Total jitter, peak to peak	RPAT, 6.4 Gbps	19.5			ps
		RPAT, 12.8 Gbps	24			

6.12 Typical Characteristics - ADC32RF54

Typical values are at $T_A = 25^\circ\text{C}$, ADC sampling rate = 2.6 GSPS, LMFS = 8224, 50% clock duty cycle, AVDD18 = 1.8 V, AVDD12, CLKVDD, DVDD = 1.2 V and -1-dBFS differential input, unless otherwise noted

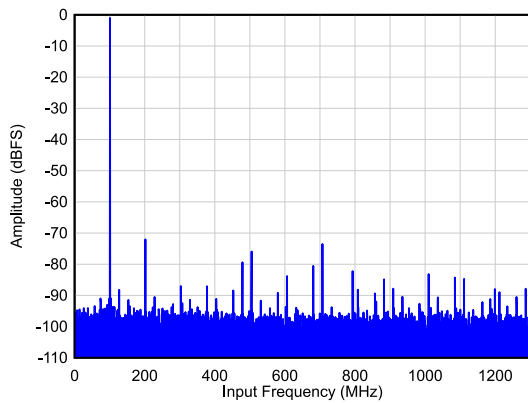

SNR = 62.1 dBFS, SFDR = 71 dBc, Non HD23 = 76 dBFS
 $A_{IN} = -1$ dBFS, 1x AVG, Dither = DIS

Figure 6-1. Single Tone FFT at $F_{IN} = 100$ MHz

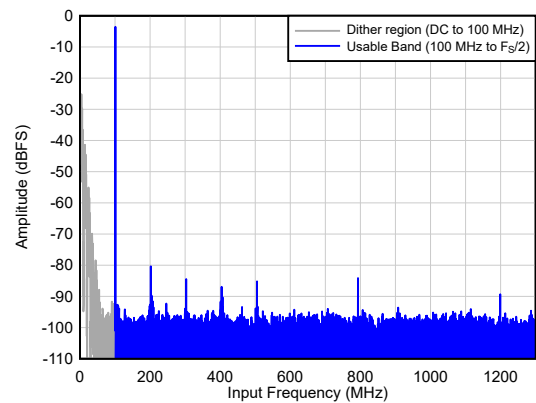

SNR = 63.2 dBFS¹, SFDR = 77 dBc, Non HD23 = 87 dBFS
 $A_{IN} = -4$ dBFS, 1x AVG, Dither = EN

Figure 6-2. Single Tone FFT at $F_{IN} = 100$ MHz

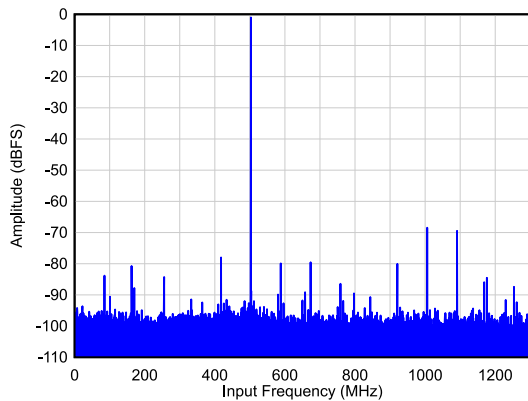

SNR = 62.1 dBFS, SFDR = 64 dBc, Non HD23 = 78 dBFS
 $A_{IN} = -1$ dBFS, 1x AVG, Dither = DIS

Figure 6-3. Single Tone FFT at $F_{IN} = 500$ MHz

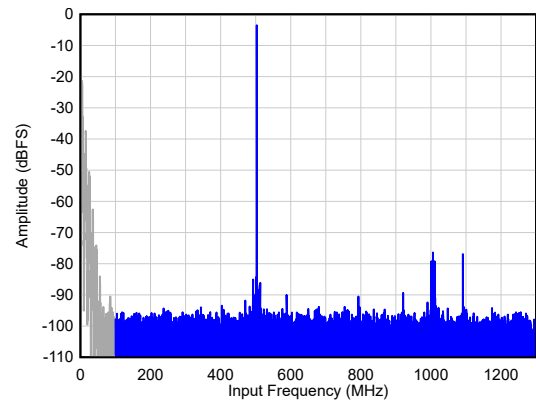

SNR = 62.4 dBFS¹, SFDR = 73 dBc, Non HD23 = 90 dBFS
 $A_{IN} = -4$ dBFS, 1x AVG, Dither = EN

Figure 6-4. Single Tone FFT at $F_{IN} = 500$ MHz

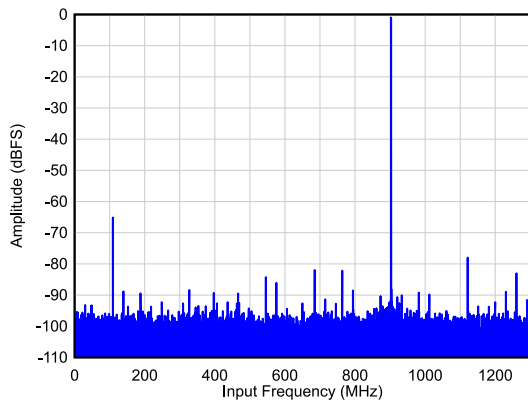

SNR = 61.8 dBFS, SFDR = 64 dBc, Non HD23 = 81 dBFS
 $A_{IN} = -1$ dBFS, 1x AVG, Dither = DIS

Figure 6-5. Single Tone FFT at $F_{IN} = 900$ MHz

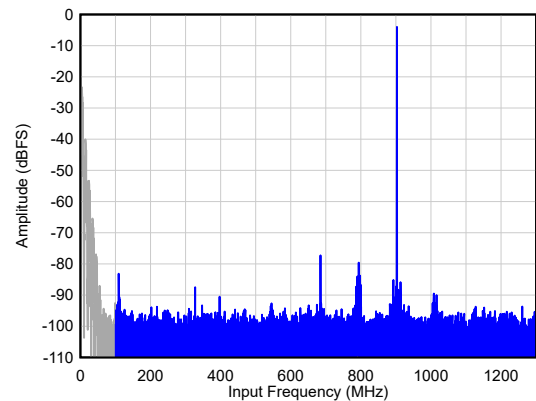

SNR = 63.1 dBFS¹, SFDR = 76 dBc, Non HD23 = 85 dBFS
 $A_{IN} = -4$ dBFS, 1x AVG, Dither = EN

Figure 6-6. Single Tone FFT at $F_{IN} = 900$ MHz

¹ Measured from 100 MHz to $F_S/2$

6.12 Typical Characteristics - ADC32RF54 (continued)

Typical values are at $T_A = 25^\circ\text{C}$, ADC sampling rate = 2.6 GSPS, LMFS = 8224, 50% clock duty cycle, AVDD18 = 1.8 V, AVDD12, CLKVDD, DVDD = 1.2 V and -1-dBFS differential input, unless otherwise noted

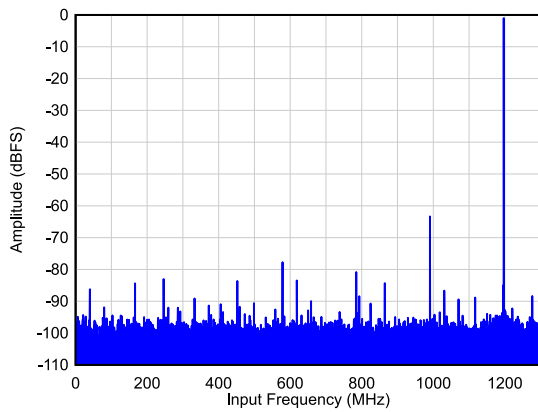

SNR = 61.0 dBFS, SFDR = 62 dBc, Non HD23 = 80 dBFS
 $A_{IN} = -1\text{ dBFS}$, 1x AVG, Dither = DIS

Figure 6-7. Single Tone FFT at $F_{IN} = 1400\text{ MHz}$

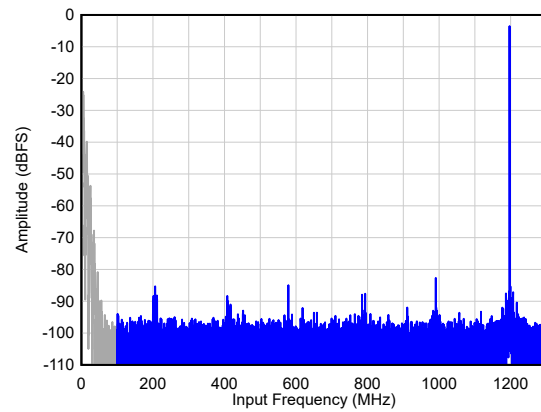

SNR = 62.5 dBFS¹, SFDR = 79 dBc, Non HD23 = 88 dBFS
 $A_{IN} = -4\text{ dBFS}$, 1x AVG, Dither = EN

Figure 6-8. Single Tone FFT at $F_{IN} = 1400\text{ MHz}$

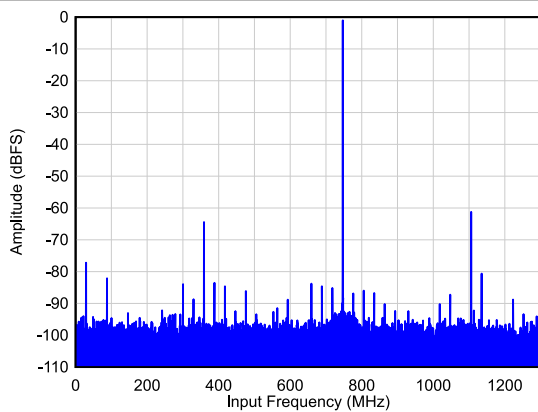

SNR = 60.9 dBFS, SFDR = 60 dBc, Non HD23 = 77 dBFS
 $A_{IN} = -1\text{ dBFS}$, 1x AVG, Dither = DIS

Figure 6-9. Single Tone FFT at $F_{IN} = 1900\text{ MHz}$

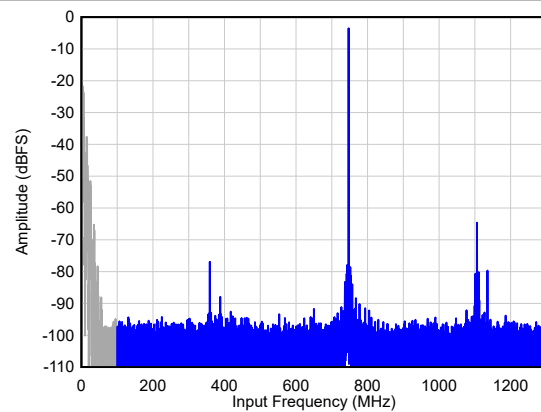

SNR = 62.3 dBFS¹, SFDR = 61 dBc, Non HD23 = 79 dBFS
 $A_{IN} = -4\text{ dBFS}$, 1x AVG, Dither = EN

Figure 6-10. Single Tone FFT at $F_{IN} = 1900\text{ MHz}$

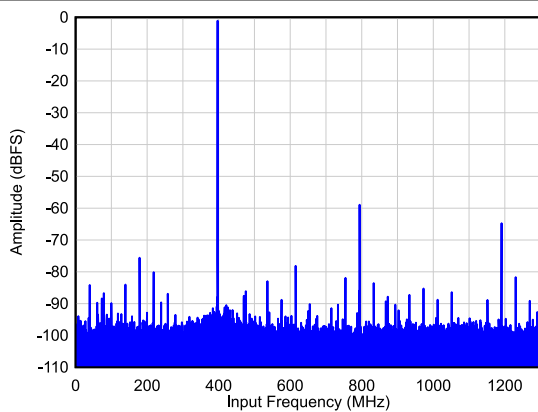

SNR = 60.2 dBFS, SFDR = 58 dBc, Non HD23 = 76 dBFS
 $A_{IN} = -1\text{ dBFS}$, 1x AVG, Dither = DIS

Figure 6-11. Single Tone FFT at $F_{IN} = 2200\text{ MHz}$

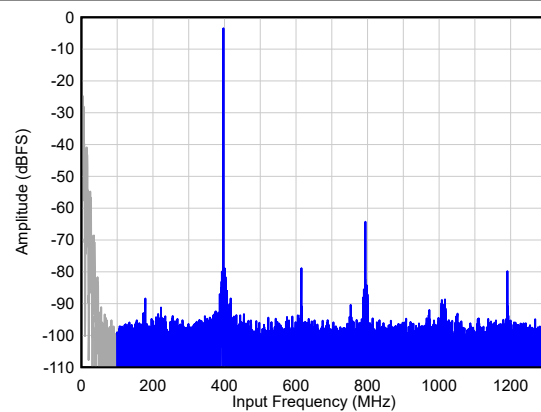

SNR = 62.6 dBFS¹, SFDR = 61 dBc, Non HD23 = 79 dBFS
 $A_{IN} = -4\text{ dBFS}$, 1x AVG, Dither = EN

Figure 6-12. Single Tone FFT at $F_{IN} = 2200\text{ MHz}$

6.12 Typical Characteristics - ADC32RF54 (continued)

Typical values are at $T_A = 25^\circ\text{C}$, ADC sampling rate = 2.6 GSPS, LMFS = 8224, 50% clock duty cycle, AVDD18 = 1.8 V, AVDD12, CLKVDD, DVDD = 1.2 V and -1-dBFS differential input, unless otherwise noted

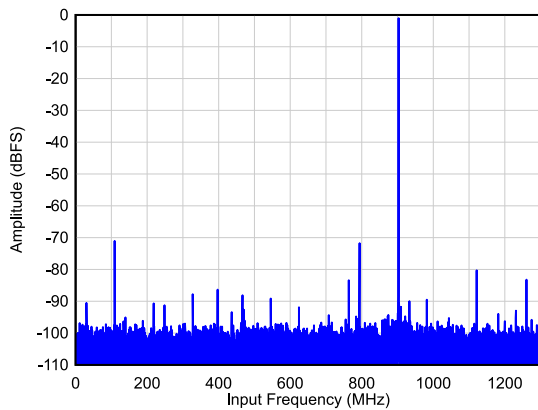

SNR = 62.8 dBFS, SFDR = 70 dBc, Non HD23 = 80 dBFS
 $A_{IN} = -1$ dBFS, 2x AVG, Dither = DIS

Figure 6-13. Single Tone FFT at $F_{IN} = 900$ MHz

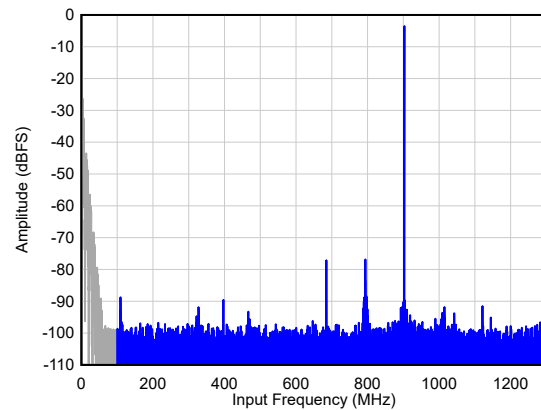

SNR = 65.4 dBFS¹, SFDR = 73 dBc, Non HD23 = 78 dBFS
 $A_{IN} = -4$ dBFS, 2x AVG, Dither = EN

Figure 6-14. Single Tone FFT at $F_{IN} = 900$ MHz

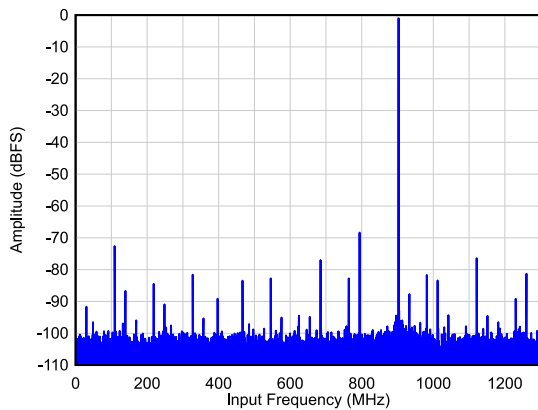

SNR = 65.6 dBFS, SFDR = 67 dBc, Non HD23 = 73 dBFS
 $A_{IN} = -1$ dBFS, 4x AVG, Dither = DIS

Figure 6-15. Single Tone FFT at $F_{IN} = 900$ MHz

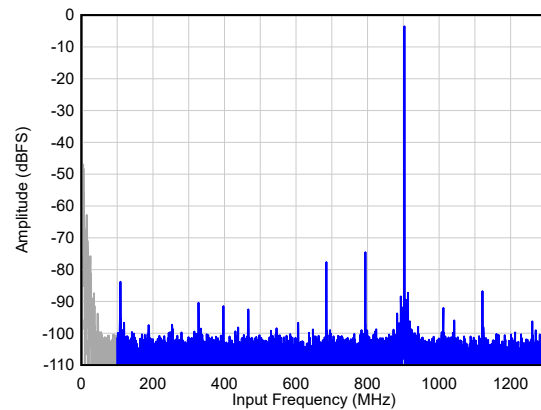

SNR = 67.8 dBFS¹, SFDR = 71 dBc, Non HD23 = 76 dBFS
 $A_{IN} = -4$ dBFS, 4x AVG, Dither = EN

Figure 6-16. Single Tone FFT at $F_{IN} = 900$ MHz

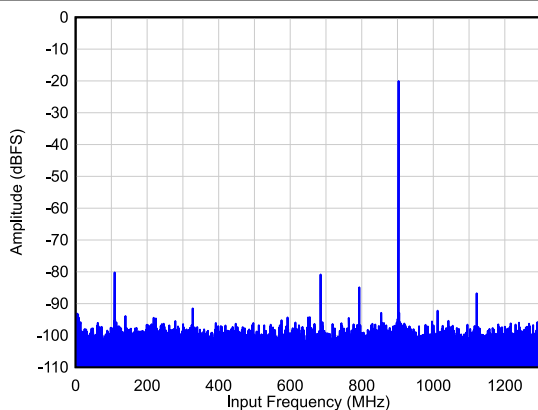

SNR = 64.4 dBFS, SFDR = 60 dBc, Non HD23 = 81 dBFS
 $A_{IN} = -20$ dBFS, 1x AVG, Dither = DIS

Figure 6-17. Single Tone FFT at $F_{IN} = 900$ MHz

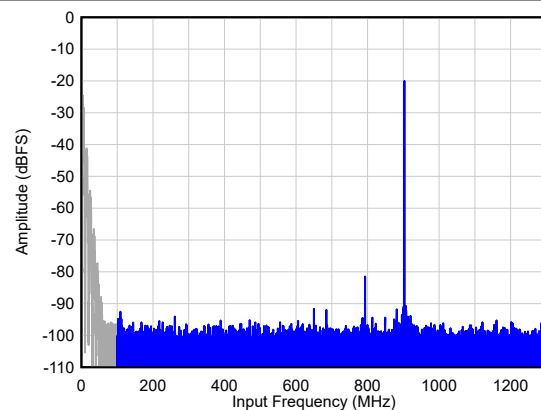

SNR = 64.6 dBFS¹, SFDR = 73 dBc, Non HD23 = 92 dBFS
 $A_{IN} = -20$ dBFS, 1x AVG, Dither = EN

Figure 6-18. Single Tone FFT at $F_{IN} = 900$ MHz

6.12 Typical Characteristics - ADC32RF54 (continued)

Typical values are at $T_A = 25^\circ\text{C}$, ADC sampling rate = 2.6 GSPS, LMFS = 8224, 50% clock duty cycle, AVDD18 = 1.8 V, AVDD12, CLKVDD, DVDD = 1.2 V and -1-dBFS differential input, unless otherwise noted

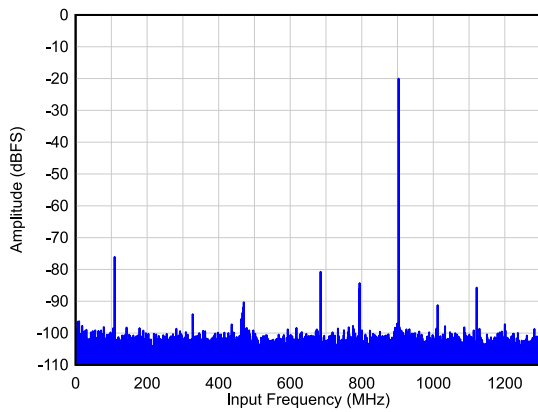

SNR = 67.1 dBFS, SFDR = 56 dBc, Non HD23 = 80 dBFS
 $A_{IN} = -20$ dBFS, 2x AVG, Dither = DIS

Figure 6-19. Single Tone FFT at $F_{IN} = 900$ MHz

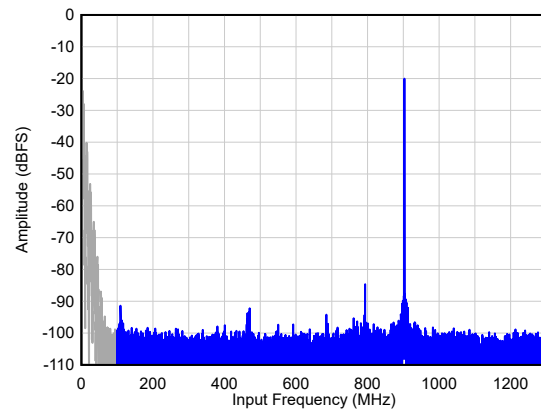

SNR = 66.8 dBFS¹, SFDR = 65 dBc, Non HD23 = 93 dBFS
 $A_{IN} = -20$ dBFS, 2x AVG, Dither = EN

Figure 6-20. Single Tone FFT at $F_{IN} = 900$ MHz

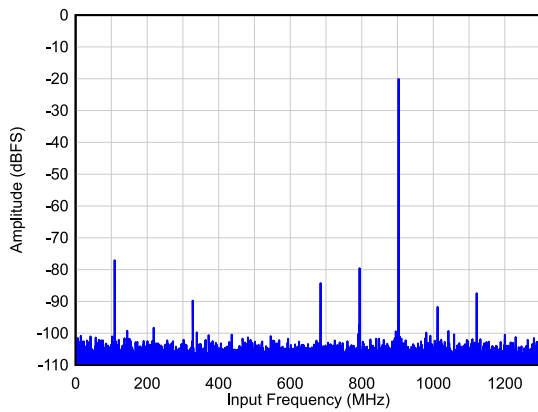

SNR = 70.0 dBFS, SFDR = 58 dBc, Non HD23 = 85 dBFS
 $A_{IN} = -20$ dBFS, 4x AVG, Dither = DIS

Figure 6-21. Single Tone FFT at $F_{IN} = 900$ MHz

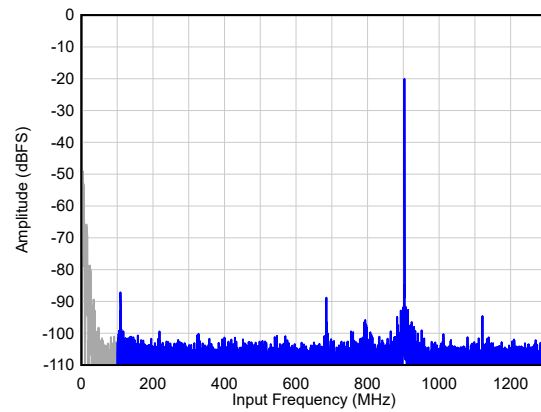

SNR = 69.5 dBFS¹, SFDR = 67 dBc, Non HD23 = 88 dBFS
 $A_{IN} = -20$ dBFS, 4x AVG, Dither = EN

Figure 6-22. Single Tone FFT at $F_{IN} = 900$ MHz

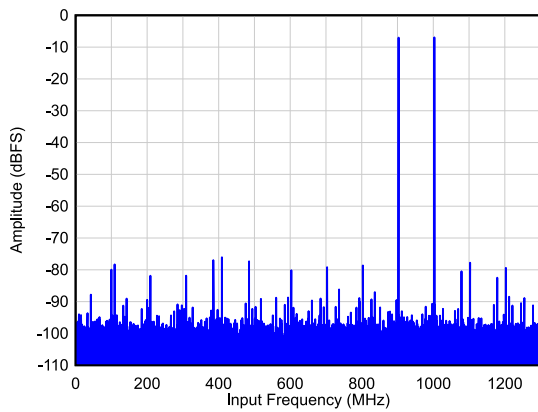

IMD3 = 72 dBc
 $A_{IN} = -7$ dBFS/tone, 1x AVG, Dither = DIS

Figure 6-23. Two Tone FFT at $F_{IN} = 900/1000$ MHz

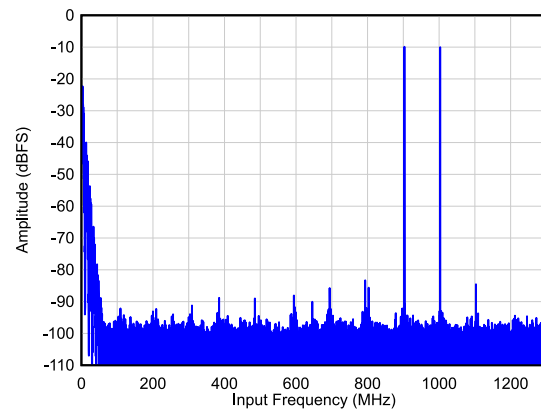

IMD3 = 74 dBc
 $A_{IN} = -10$ dBFS/tone, 1x AVG, Dither = EN

Figure 6-24. Two Tone FFT at $F_{IN} = 900/1000$ MHz

6.12 Typical Characteristics - ADC32RF54 (continued)

Typical values are at $T_A = 25^\circ\text{C}$, ADC sampling rate = 2.6 GSPS, LMFS = 8224, 50% clock duty cycle, AVDD18 = 1.8 V, AVDD12, CLKVDD, DVDD = 1.2 V and -1-dBFS differential input, unless otherwise noted

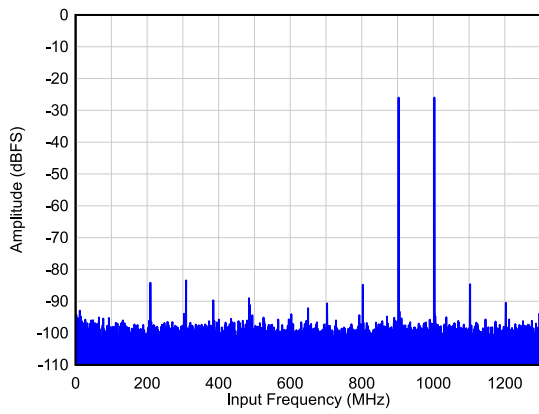

IMD3 = 60 dBc
 $A_{IN} = -26$ dBFS/tone, 1x AVG, Dither = DIS

Figure 6-25. Two Tone FFT at $F_{IN} = 900/1000$ MHz

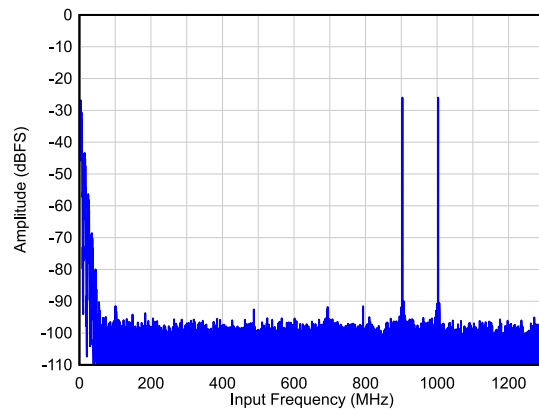

IMD3 = 72 dBc
 $A_{IN} = -26$ dBFS/tone, 1x AVG, Dither = EN

Figure 6-26. Two Tone FFT at $F_{IN} = 900/1000$ MHz

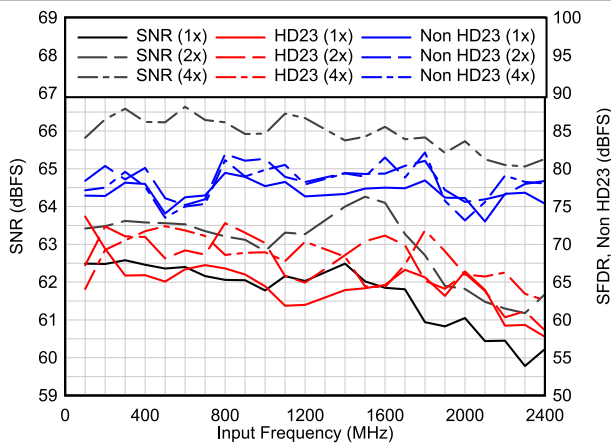

$A_{IN} = -1$ dBFS, Dither = DIS

Figure 6-27. AC Performance vs F_{IN}

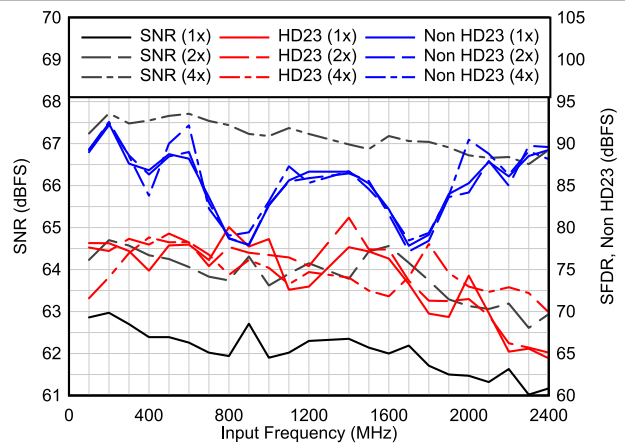

$A_{IN} = -4$ dBFS, Dither = EN

Figure 6-28. AC Performance vs F_{IN}

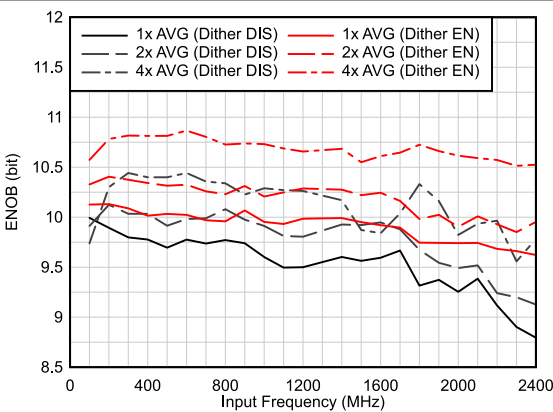

$A_{IN} = -1$ dBFS (Dither = DIS)
 $A_{IN} = -4$ dBFS (Dither = EN)

Figure 6-29. ENOB Performance vs F_{IN}

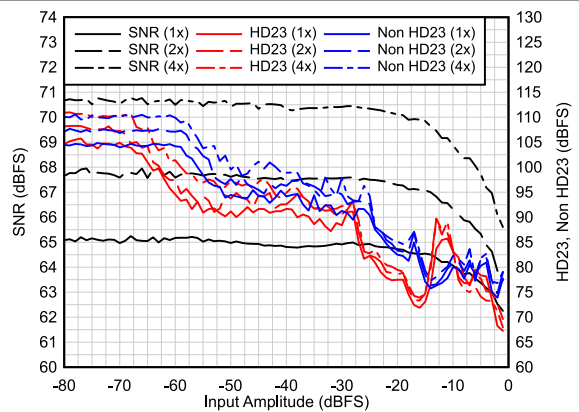

$F_{IN} = 900$ MHz, Dither = DIS

Figure 6-30. AC Performance vs A_{IN}

6.12 Typical Characteristics - ADC32RF54 (continued)

Typical values are at $T_A = 25^\circ\text{C}$, ADC sampling rate = 2.6 GSPS, LMFS = 8224, 50% clock duty cycle, AVDD18 = 1.8 V, AVDD12, CLKVDD, DVDD = 1.2 V and -1-dBFS differential input, unless otherwise noted

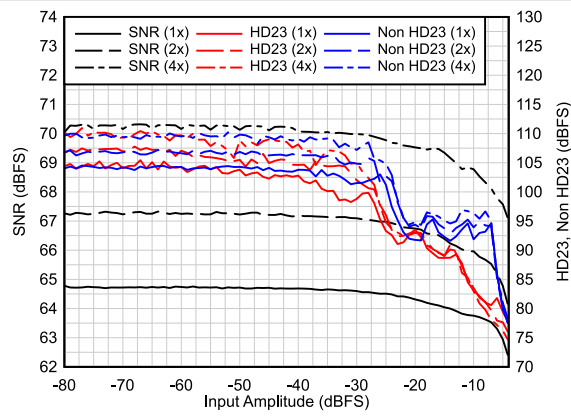

$F_{IN} = 900\text{ MHz}$, Dither = EN

Figure 6-31. AC Performance vs A_{IN}

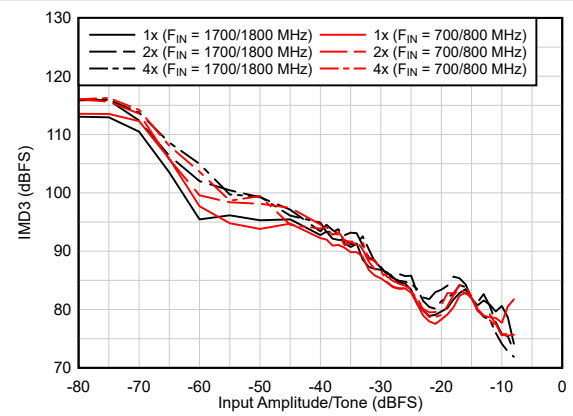

Dither = DIS

Figure 6-32. IMD3 Performance vs A_{IN}

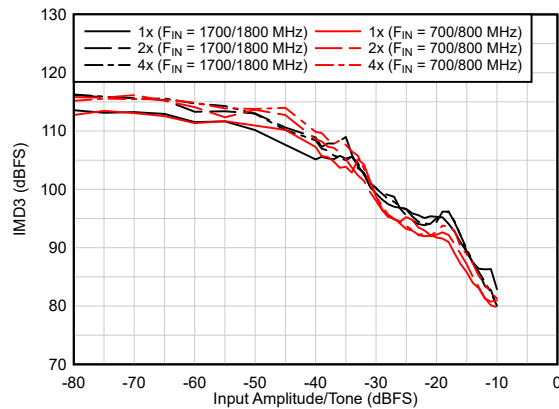

Dither = EN

Figure 6-33. IMD3 Performance vs A_{IN}

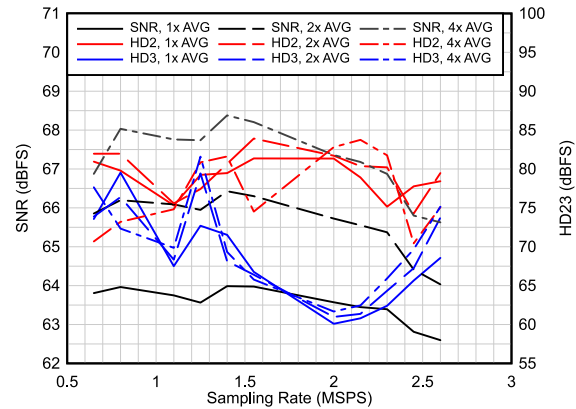

$F_{IN} = 900\text{ MHz}$, $A_{IN} = -1\text{ dBFS}$, Dither = DIS

Figure 6-34. AC Performance vs F_S

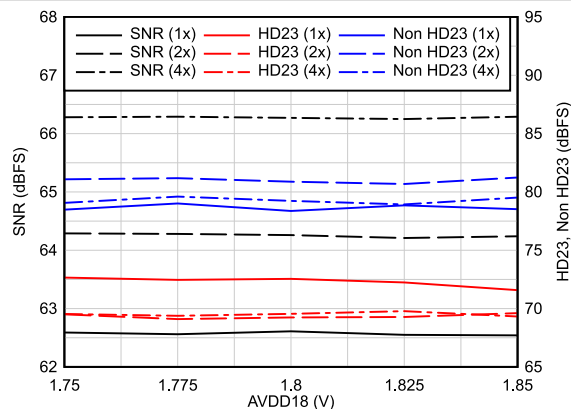

$F_{IN} = 900\text{ MHz}$, $A_{IN} = -1\text{ dBFS}$, Dither = DIS, Other supplies nominal

Figure 6-35. AC Performance vs AVDD18

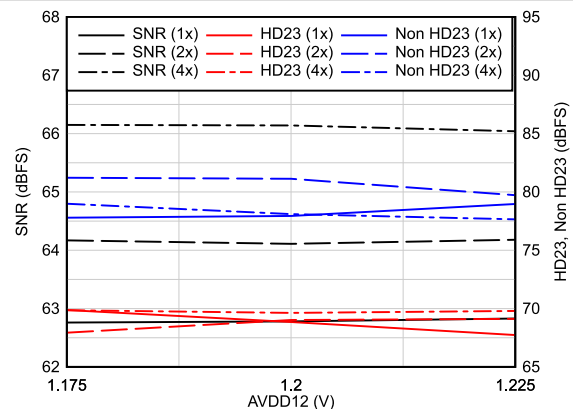

$F_{IN} = 900\text{ MHz}$, $A_{IN} = -1\text{ dBFS}$, Dither = DIS, Other supplies nominal

Figure 6-36. AC Performance vs AVDD12

6.12 Typical Characteristics - ADC32RF54 (continued)

Typical values are at $T_A = 25^\circ\text{C}$, ADC sampling rate = 2.6 GSPS, LMFS = 8224, 50% clock duty cycle, AVDD18 = 1.8 V, AVDD12, CLKVDD, DVDD = 1.2 V and -1-dBFS differential input, unless otherwise noted

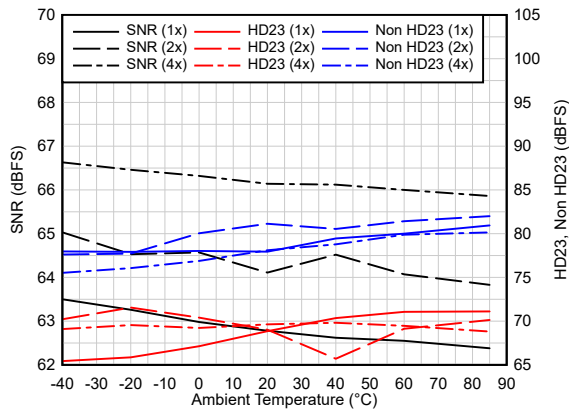

$F_{IN} = 900\text{ MHz}$, $A_{IN} = -1\text{ dBFS}$, Dither = DIS

Figure 6-37. AC Performance vs Temperature

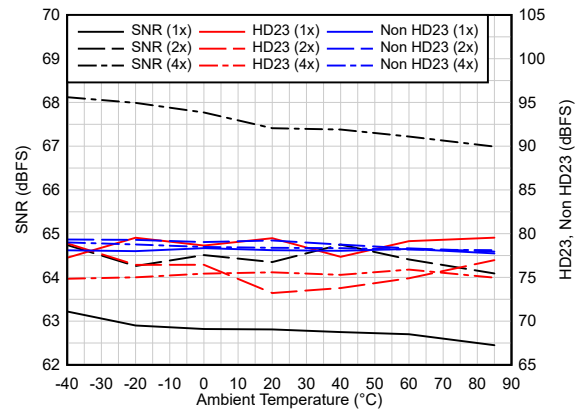

$F_{IN} = 900\text{ MHz}$, $A_{IN} = -4\text{ dBFS}$, Dither = EN

Figure 6-38. AC Performance vs Temperature

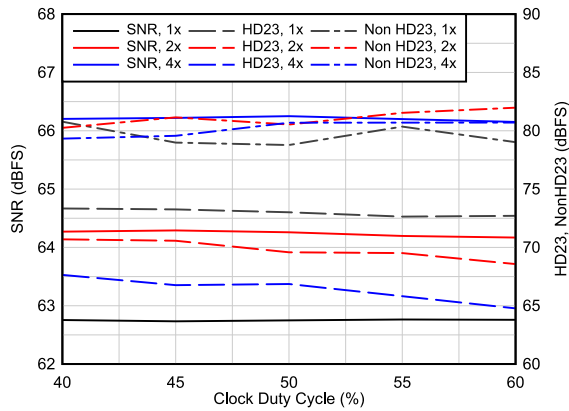

$F_{IN} = 900\text{ MHz}$, $A_{IN} = -1\text{ dBFS}$, Dither = DIS

Figure 6-39. AC Performance vs Clock Duty Cycle

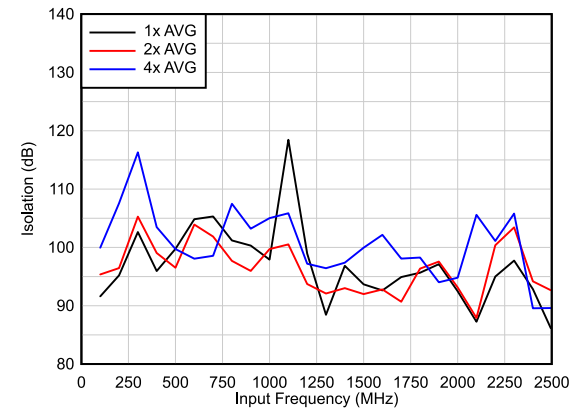
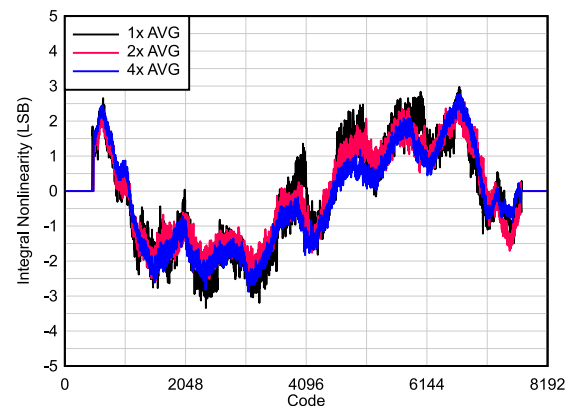
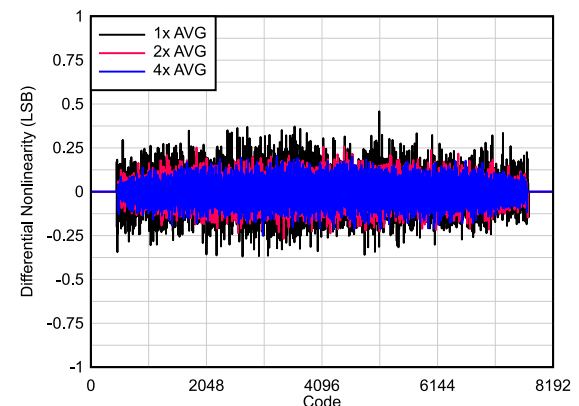

Figure 6-40. Isolation vs Input Frequency



$F_{IN} = 900\text{ MHz}$, Dither = DIS

Figure 6-41. INL vs Code



$F_{IN} = 900\text{ MHz}$, Dither = DIS

Figure 6-42. DNL vs Code

6.12 Typical Characteristics - ADC32RF54 (continued)

Typical values are at $T_A = 25^\circ\text{C}$, ADC sampling rate = 2.6 GSPS, LMFS = 8224, 50% clock duty cycle, AVDD18 = 1.8 V, AVDD12, CLKVDD, DVDD = 1.2 V and -1-dBFS differential input, unless otherwise noted

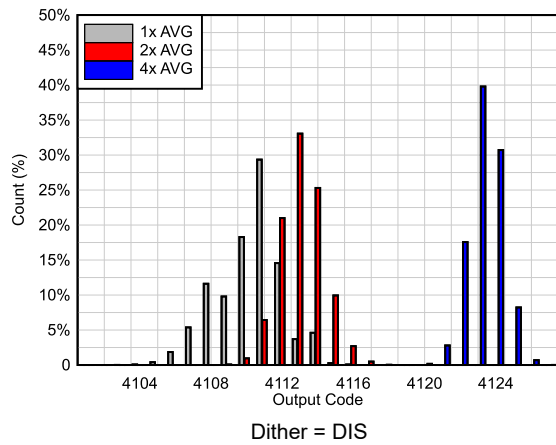
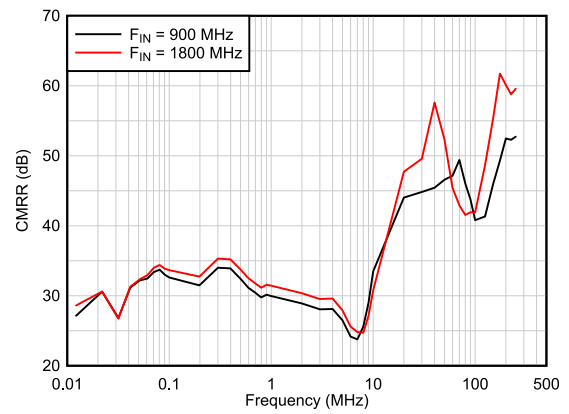
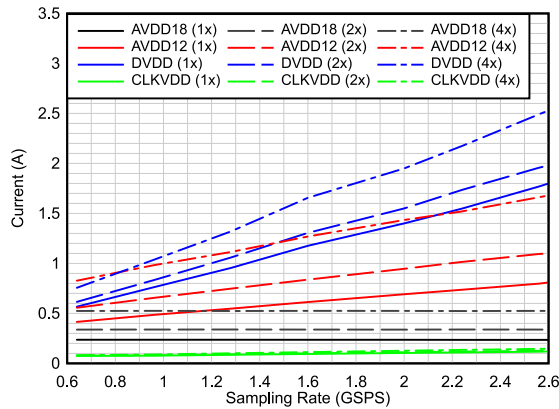

Figure 6-43. DC Offset Histogram



$A_{IN} = -1\text{ dBFS}$, 1x AVG, Dither = DIS

Figure 6-44. CMRR



$A_{IN} = -1\text{ dBFS}$, Dither = DIS, DDC Bypass

Figure 6-45. Current vs Sampling Rate vs Averaging

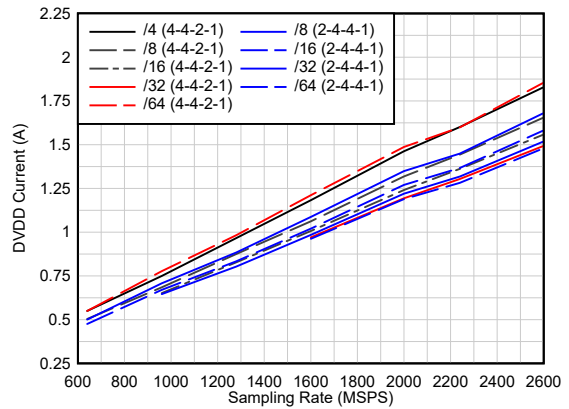

$A_{IN} = -1\text{ dBFS}$, 1x AVG, Dither = DIS
Single Band Decimation

Figure 6-46. Current vs Sampling Rate vs Decimation

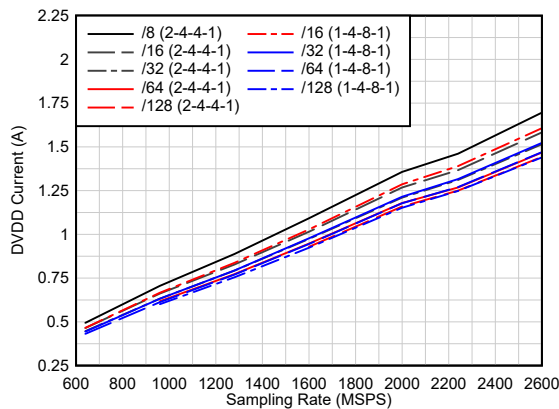

$A_{IN} = -1\text{ dBFS}$, 1x AVG, Dither = DIS
Single Band Decimation

Figure 6-47. Current vs Sampling Rate vs Decimation

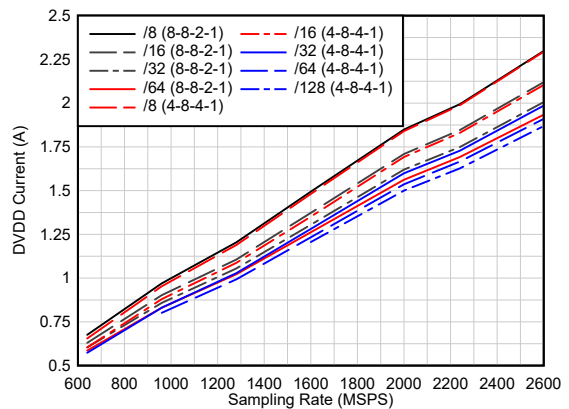

$A_{IN} = -1\text{ dBFS}$, 1x AVG, Dither = DIS
Dual Band Decimation

Figure 6-48. Current vs Sampling Rate vs Decimation

ADC32RF54, ADC32RF55

SBAS500A – JUNE 2022 – REVISED DECEMBER 2022

6.12 Typical Characteristics - ADC32RF54 (continued)

Typical values are at $T_A = 25^\circ\text{C}$, ADC sampling rate = 2.6 GSPS, LMFS = 8224, 50% clock duty cycle, AVDD18 = 1.8 V, AVDD12, CLKVDD, DVDD = 1.2 V and -1-dBFS differential input, unless otherwise noted

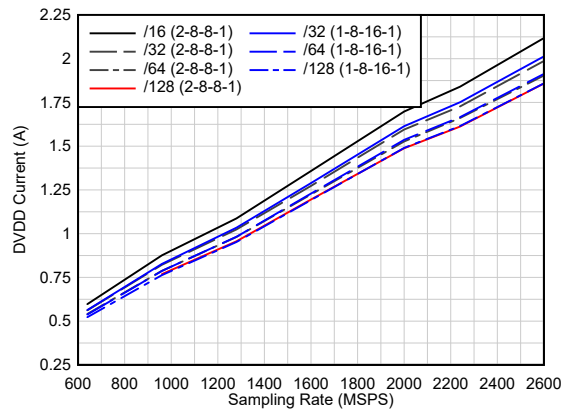

$A_{IN} = -1$ dBFS, 1x AVG, Dither = DIS
Dual Band Decimation

Figure 6-49. Current vs Sampling Rate vs Decimation

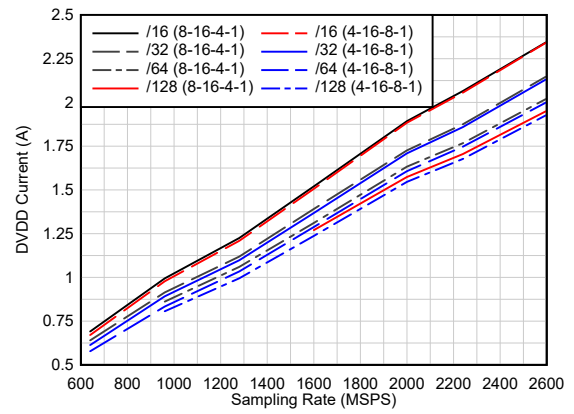

$A_{IN} = -1$ dBFS, 1x AVG, Dither = DIS
Quad Band Decimation

Figure 6-50. Current vs Sampling Rate vs Decimation

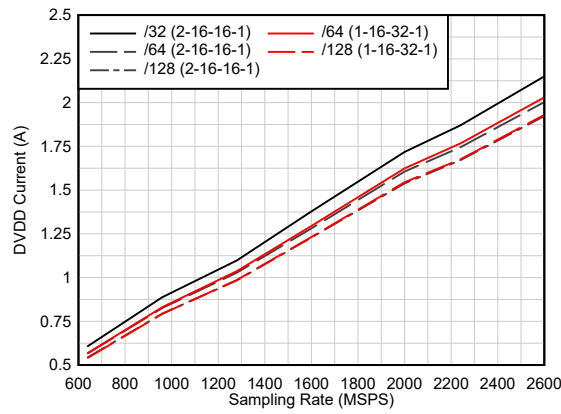

$A_{IN} = -1$ dBFS, 1x AVG, Dither = DIS
Quad Band Decimation

Figure 6-51. Current vs Sampling Rate vs Decimation

6.13 Typical Characteristics - ADC32RF55

Typical values are at $T_A = 25^\circ\text{C}$, ADC sampling rate = 3 GSPS, LMFS = 82820, 50% clock duty cycle, AVDD18 = 1.8 V, AVDD12, CLKVDD, DVDD = 1.2 V and -1-dBFS differential input, unless otherwise noted

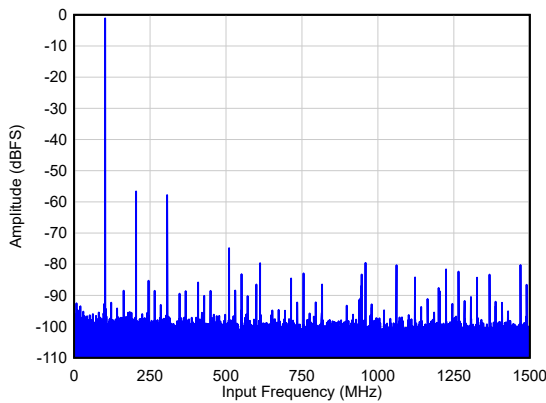

SNR = 62.1 dBFS, SFDR = 57 dBc, Non HD23 = 75 dBFS
 $A_{IN} = -1\text{ dBFS}$, 1x AVG, Dither = DIS

Figure 6-52. Single Tone FFT at $F_{IN} = 100\text{ MHz}$

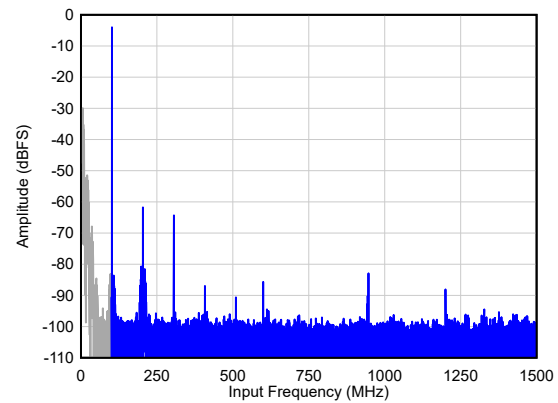

SNR = 61.7 dBFS², SFDR = 58 dBc, Non HD23 = 83 dBFS
 $A_{IN} = -4\text{ dBFS}$, 1x AVG, Dither = EN

Figure 6-53. Single Tone FFT at $F_{IN} = 100\text{ MHz}$

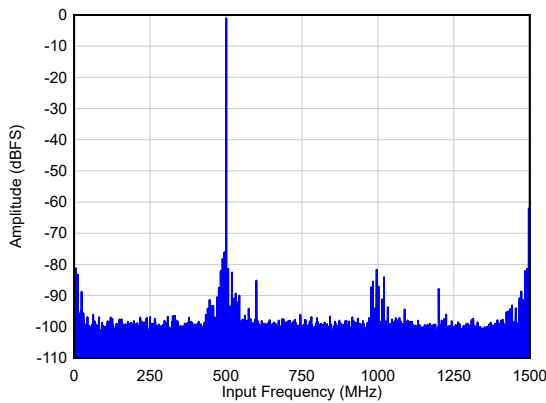

SNR = 61.9 dBFS, SFDR = 63 dBc, Non HD23 = 77 dBFS
 $A_{IN} = -1\text{ dBFS}$, 1x AVG, Dither = DIS

Figure 6-54. Single Tone FFT at $F_{IN} = 500\text{ MHz}$

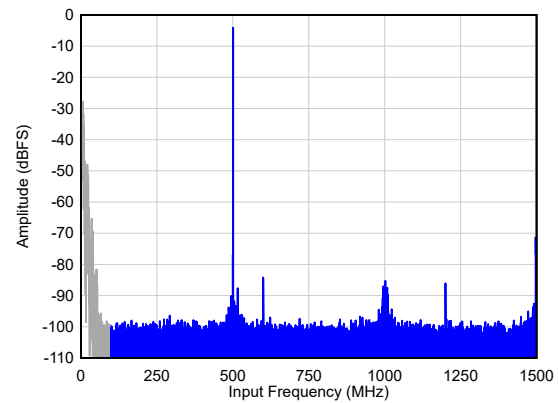

SNR = 61.8 dBFS¹, SFDR = 68 dBc, Non HD23 = 84 dBFS
 $A_{IN} = -4\text{ dBFS}$, 1x AVG, Dither = EN

Figure 6-55. Single Tone FFT at $F_{IN} = 500\text{ MHz}$

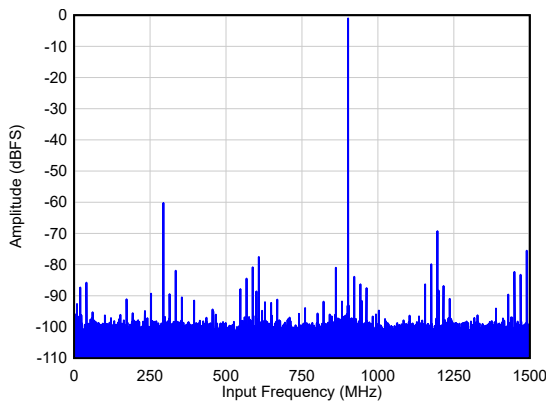

SNR = 61.8 dBFS, SFDR = 60 dBc, Non HD23 = 76 dBFS
 $A_{IN} = -1\text{ dBFS}$, 1x AVG, Dither = DIS

Figure 6-56. Single Tone FFT at $F_{IN} = 900\text{ MHz}$

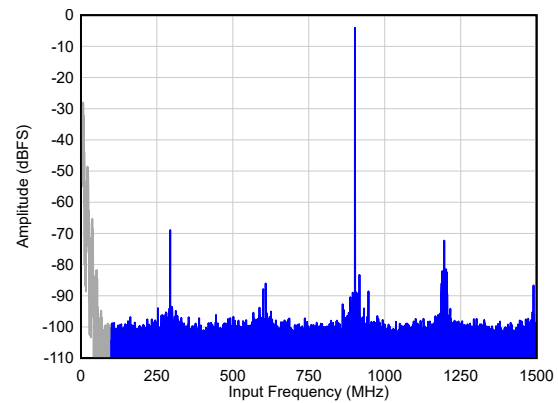

SNR = 60.9 dBFS¹, SFDR = 64 dBc, Non HD23 = 82 dBFS
 $A_{IN} = -4\text{ dBFS}$, 1x AVG, Dither = EN

Figure 6-57. Single Tone FFT at $F_{IN} = 900\text{ MHz}$

² Measured from 100 MHz to $F_S/2$

6.13 Typical Characteristics - ADC32RF55 (continued)

Typical values are at $T_A = 25^\circ\text{C}$, ADC sampling rate = 3 GSPS, LMFS = 82820, 50% clock duty cycle, AVDD18 = 1.8 V, AVDD12, CLKVDD, DVDD = 1.2 V and -1-dBFS differential input, unless otherwise noted

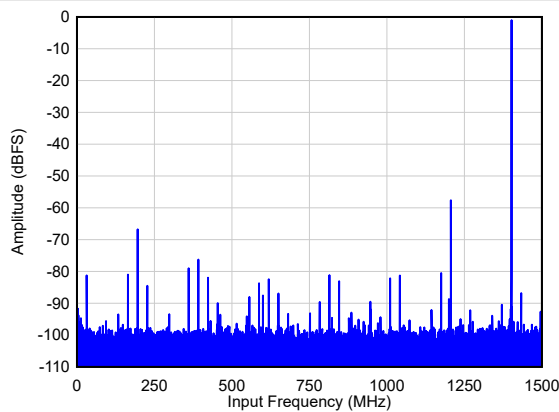

SNR = 62.1 dBFS, SFDR = 57 dBc, Non HD23 = 76 dBFS
 $A_{IN} = -1\text{ dBFS}$, 1x AVG, Dither = DIS

Figure 6-58. Single Tone FFT at $F_{IN} = 1400\text{ MHz}$

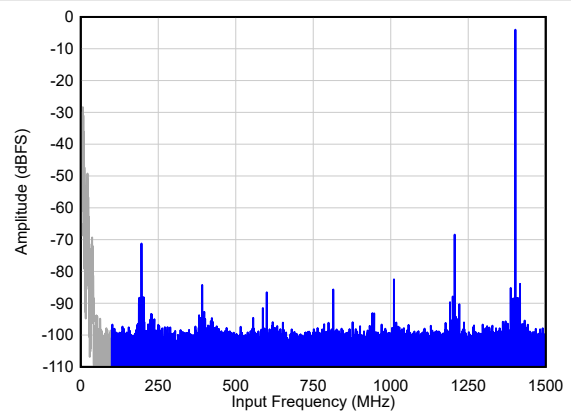

SNR = 62.2 dBFS¹, SFDR = 63 dBc, Non HD23 = 83 dBFS
 $A_{IN} = -4\text{ dBFS}$, 1x AVG, Dither = EN

Figure 6-59. Single Tone FFT at $F_{IN} = 1400\text{ MHz}$

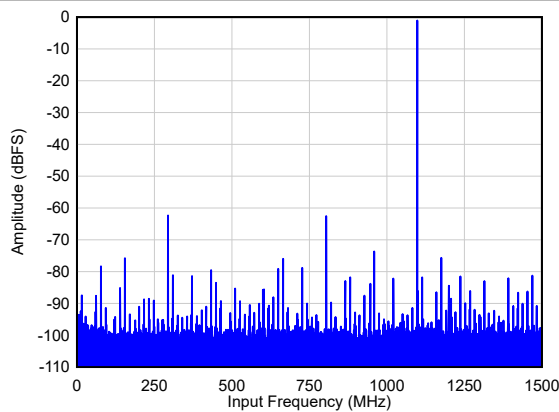

SNR = 60.9 dBFS, SFDR = 62 dBc, Non HD23 = 74 dBFS
 $A_{IN} = -1\text{ dBFS}$, 1x AVG, Dither = DIS

Figure 6-60. Single Tone FFT at $F_{IN} = 1900\text{ MHz}$

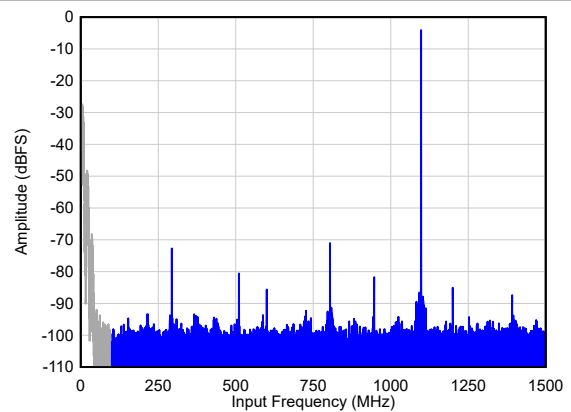

SNR = 61.2 dBFS¹, SFDR = 67 dBc, Non HD23 = 80 dBFS
 $A_{IN} = -4\text{ dBFS}$, 1x AVG, Dither = EN

Figure 6-61. Single Tone FFT at $F_{IN} = 1900\text{ MHz}$

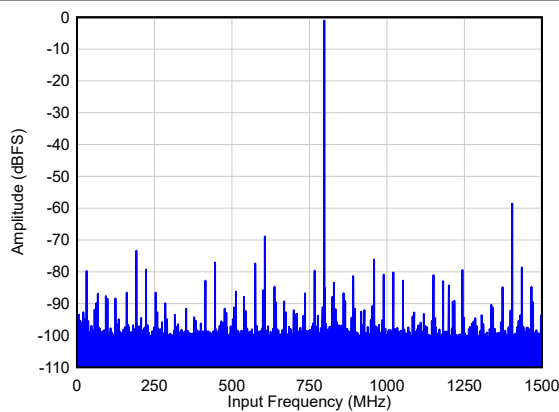

SNR = 60.4 dBFS, SFDR = 58 dBc, Non HD23 = 73 dBFS
 $A_{IN} = -1\text{ dBFS}$, 1x AVG, Dither = DIS

Figure 6-62. Single Tone FFT at $F_{IN} = 2200\text{ MHz}$

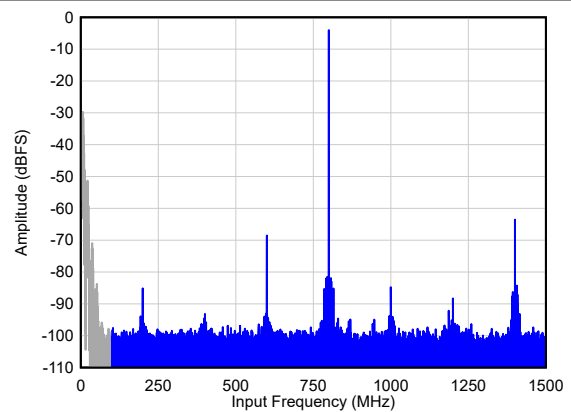

SNR = 61.1 dBFS¹, SFDR = 60 dBc, Non HD23 = 82 dBFS
 $A_{IN} = -4\text{ dBFS}$, 1x AVG, Dither = EN

Figure 6-63. Single Tone FFT at $F_{IN} = 2200\text{ MHz}$

6.13 Typical Characteristics - ADC32RF55 (continued)

Typical values are at $T_A = 25^\circ\text{C}$, ADC sampling rate = 3 GSPS, LMFS = 82820, 50% clock duty cycle, AVDD18 = 1.8 V, AVDD12, CLKVDD, DVDD = 1.2 V and -1-dBFS differential input, unless otherwise noted

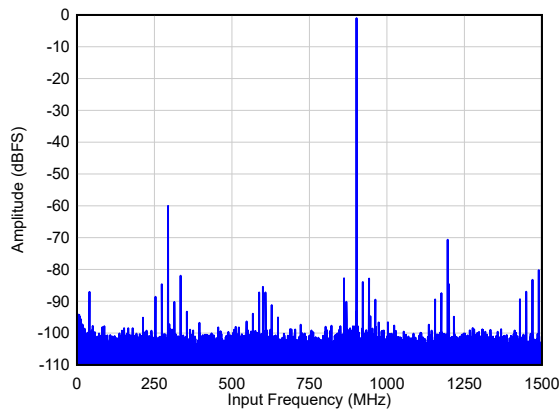

SNR = 63.5 dBFS, SFDR = 59 dBc, Non HD23 = 80 dBFS
 $A_{IN} = -1\text{ dBFS}$, 2x AVG, Dither = DIS

Figure 6-64. Single Tone FFT at $F_{IN} = 900\text{ MHz}$

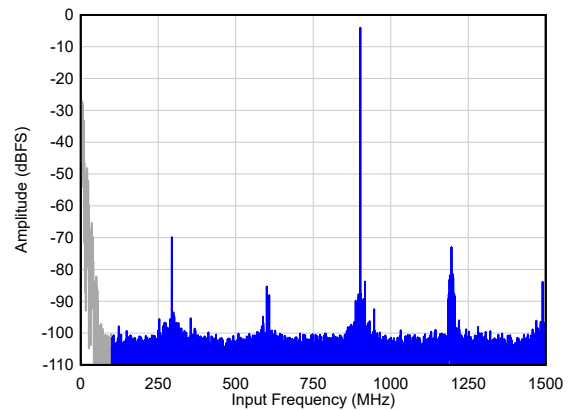

SNR = 62.3 dBFS¹, SFDR = 66 dBc, Non HD23 = 82 dBFS
 $A_{IN} = -4\text{ dBFS}$, 2x AVG, Dither = EN

Figure 6-65. Single Tone FFT at $F_{IN} = 900\text{ MHz}$

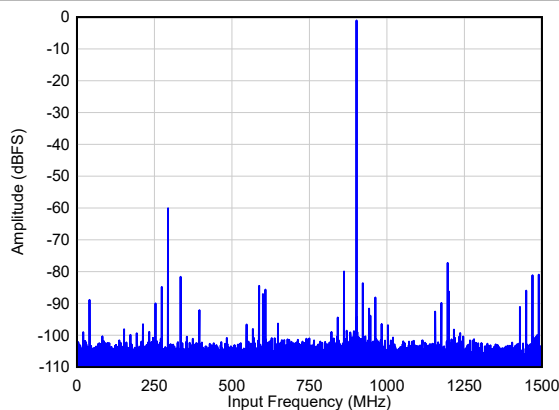

SNR = 65.6 dBFS, SFDR = 60 dBc, Non HD23 = 80 dBFS
 $A_{IN} = -1\text{ dBFS}$, 4x AVG, Dither = DIS

Figure 6-66. Single Tone FFT at $F_{IN} = 900\text{ MHz}$

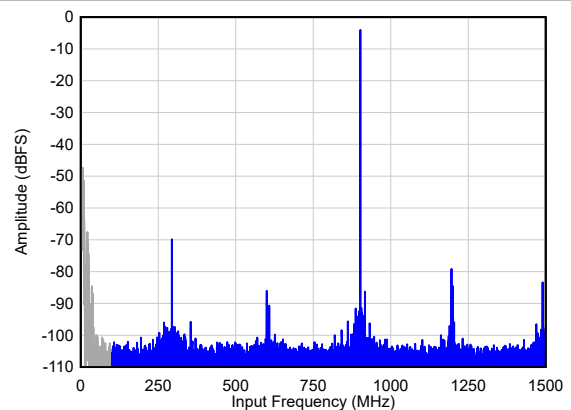

SNR = 66.2 dBFS¹, SFDR = 66 dBc, Non HD23 = 83 dBFS
 $A_{IN} = -4\text{ dBFS}$, 4x AVG, Dither = EN

Figure 6-67. Single Tone FFT at $F_{IN} = 900\text{ MHz}$

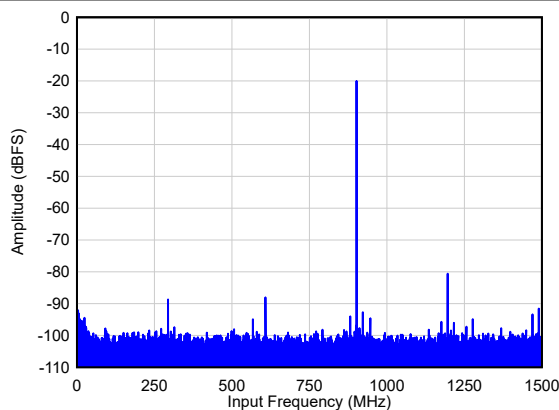

SNR = 63.9 dBFS, SFDR = 60 dBc, Non HD23 = 87 dBFS
 $A_{IN} = -20\text{ dBFS}$, 1x AVG, Dither = DIS

Figure 6-68. Single Tone FFT at $F_{IN} = 900\text{ MHz}$

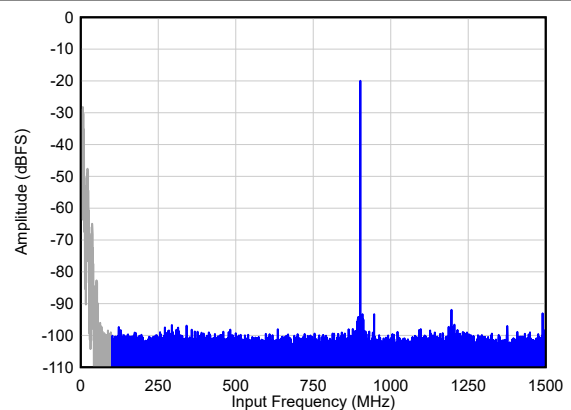

SNR = 63.4 dBFS¹, SFDR = 73 dBc, Non HD23 = 92 dBFS
 $A_{IN} = -20\text{ dBFS}$, 1x AVG, Dither = EN

Figure 6-69. Single Tone FFT at $F_{IN} = 900\text{ MHz}$

6.13 Typical Characteristics - ADC32RF55 (continued)

Typical values are at $T_A = 25^\circ\text{C}$, ADC sampling rate = 3 GSPS, LMFS = 82820, 50% clock duty cycle, AVDD18 = 1.8 V, AVDD12, CLKVDD, DVDD = 1.2 V and -1-dBFS differential input, unless otherwise noted

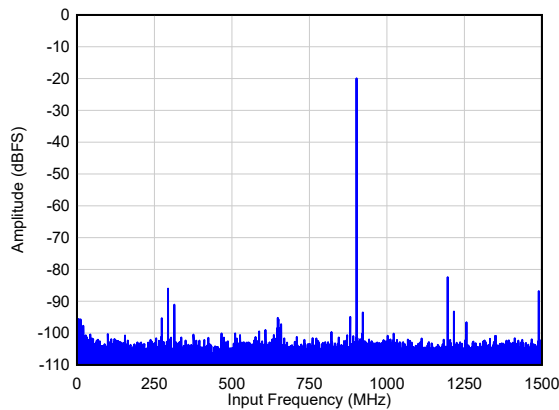

SNR = 66.4 dBFS, SFDR = 63 dBc, Non HD23 = 86 dBFS
 $A_{IN} = -20$ dBFS, 2x AVG, Dither = DIS

Figure 6-70. Single Tone FFT at $F_{IN} = 900$ MHz

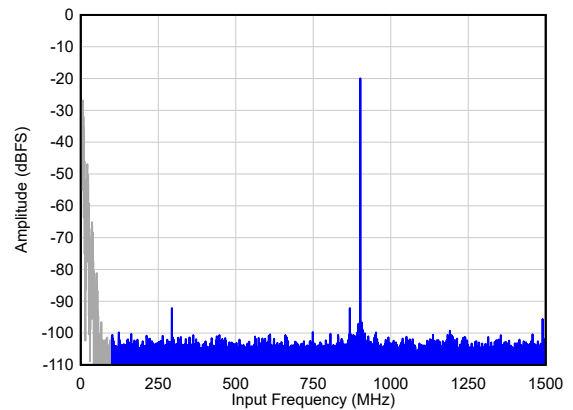

SNR = 65.5 dBFS¹, SFDR = 73 dBc, Non HD23 = 95 dBFS
 $A_{IN} = -20$ dBFS, 2x AVG, Dither = EN

Figure 6-71. Single Tone FFT at $F_{IN} = 900$ MHz

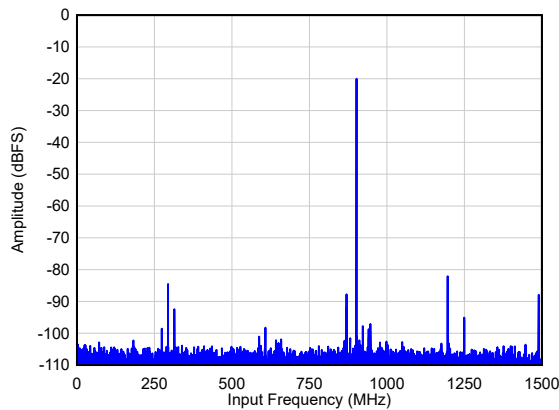

SNR = 68.7 dBFS, SFDR = 62 dBc, Non HD23 = 87 dBFS
 $A_{IN} = -20$ dBFS, 4x AVG, Dither = DIS

Figure 6-72. Single Tone FFT at $F_{IN} = 900$ MHz

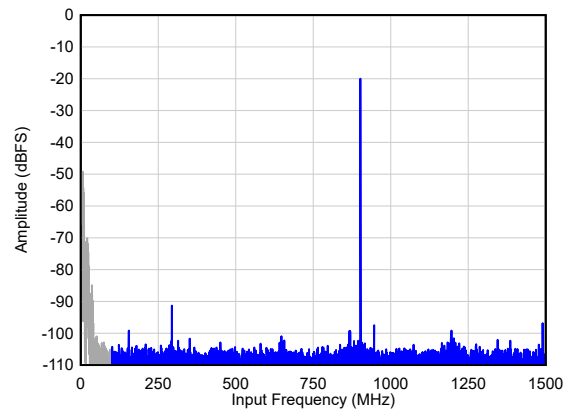

SNR = 68.1 dBFS¹, SFDR = 71 dBc, Non HD23 = 78 dBFS
 $A_{IN} = -20$ dBFS, 4x AVG, Dither = EN

Figure 6-73. Single Tone FFT at $F_{IN} = 900$ MHz

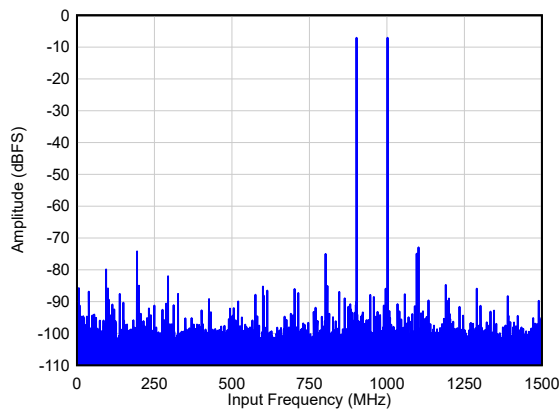

IMD3 = 68 dBc
 $A_{IN} = -7$ dBFS/tone, 1x AVG, Dither = DIS

Figure 6-74. Two Tone FFT at $F_{IN} = 900/1000$ MHz

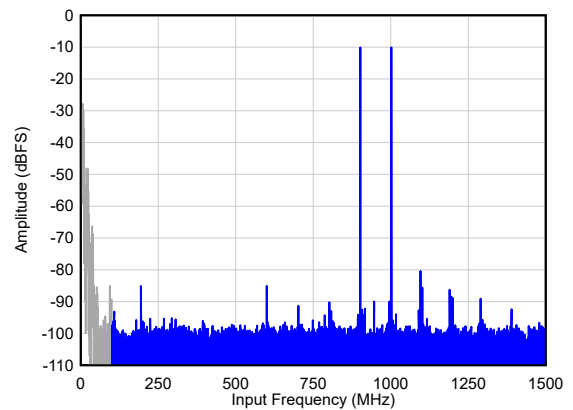

IMD3 = 70 dBc
 $A_{IN} = -10$ dBFS/tone, 1x AVG, Dither = EN

Figure 6-75. Two Tone FFT at $F_{IN} = 900/1000$ MHz

6.13 Typical Characteristics - ADC32RF55 (continued)

Typical values are at $T_A = 25^\circ\text{C}$, ADC sampling rate = 3 GSPS, LMFS = 82820, 50% clock duty cycle, AVDD18 = 1.8 V, AVDD12, CLKVDD, DVDD = 1.2 V and -1-dBFS differential input, unless otherwise noted

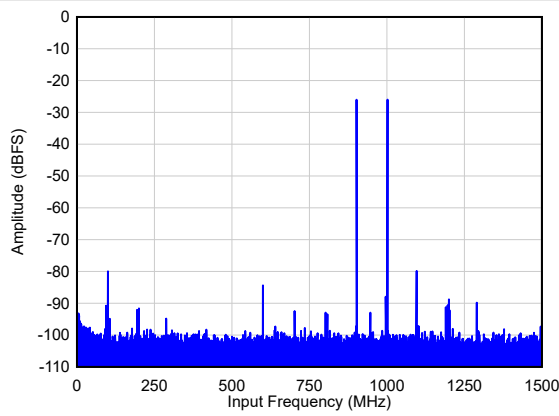

IMD3 = 54 dBc
 $A_{IN} = -26$ dBFS/tone, 1x AVG, Dither = DIS

Figure 6-76. Two Tone FFT at $F_{IN} = 900/1000$ MHz

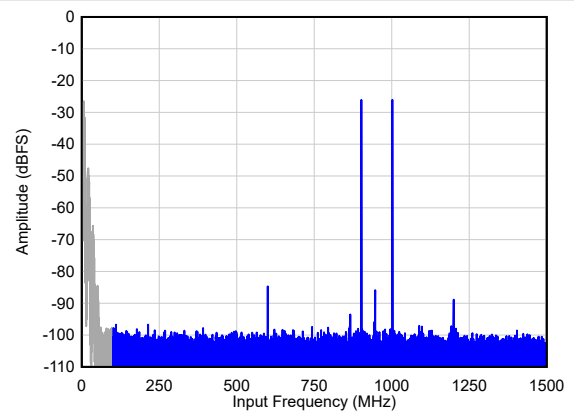

IMD3 = 71 dBc
 $A_{IN} = -26$ dBFS/tone, 1x AVG, Dither = EN

Figure 6-77. Two Tone FFT at $F_{IN} = 900/1000$ MHz

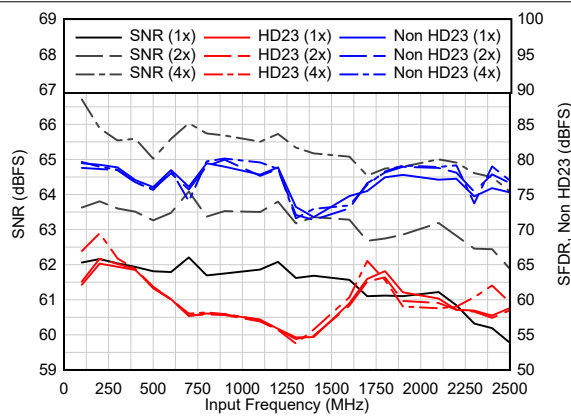

$A_{IN} = -1$ dBFS, Dither = DIS

Figure 6-78. AC Performance vs F_{IN}

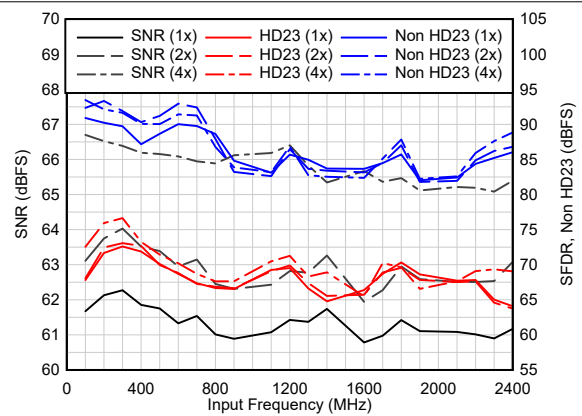

$A_{IN} = -4$ dBFS, Dither = EN

Figure 6-79. AC Performance vs F_{IN}

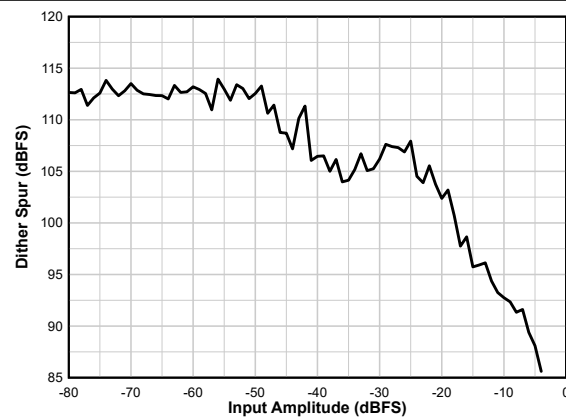

$F_{IN} = 900$ MHz,

Figure 6-80. Dither Spur vs A_{IN}

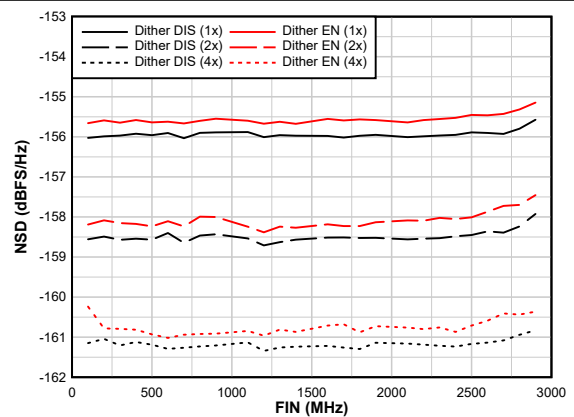

$A_{IN} = -20$ dBFS

Figure 6-81. NSD Performance vs F_{IN}

6.13 Typical Characteristics - ADC32RF55 (continued)

Typical values are at $T_A = 25^\circ\text{C}$, ADC sampling rate = 3 GSPS, LMFS = 82820, 50% clock duty cycle, AVDD18 = 1.8 V, AVDD12, CLKVDD, DVDD = 1.2 V and -1-dBFS differential input, unless otherwise noted

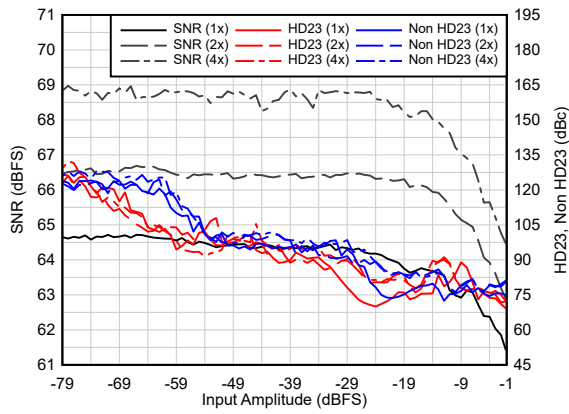

$F_{IN} = 900\text{ MHz}$, Dither = DIS

Figure 6-82. AC Performance vs A_{IN}

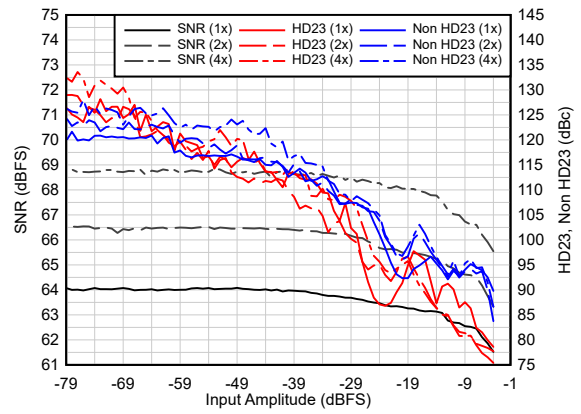

$F_{IN} = 900\text{ MHz}$, Dither = EN

Figure 6-83. AC Performance vs A_{IN}

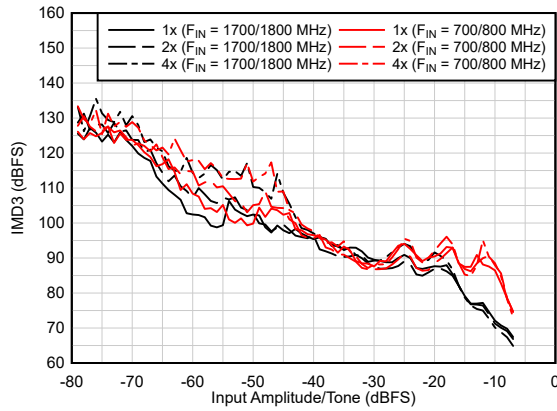

Dither = DIS

Figure 6-84. IMD3 Performance vs A_{IN}

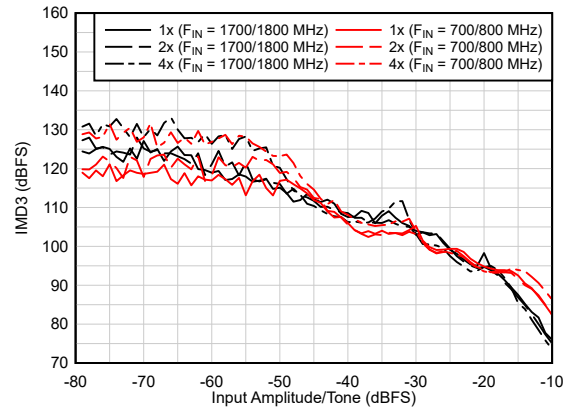

Dither = EN

Figure 6-85. IMD3 Performance vs A_{IN}

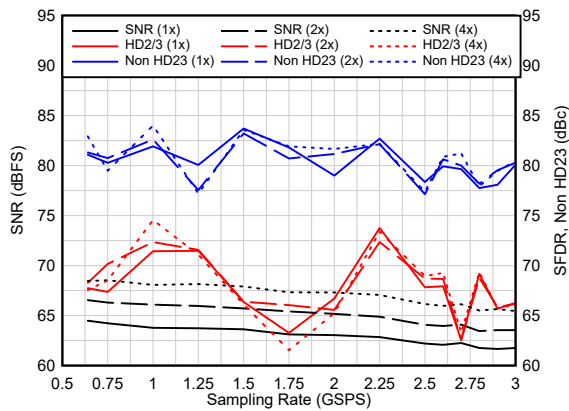

$F_{IN} = 900\text{ MHz}$, $A_{IN} = -1\text{ dBFS}$, Dither = DIS

Figure 6-86. AC Performance vs F_S

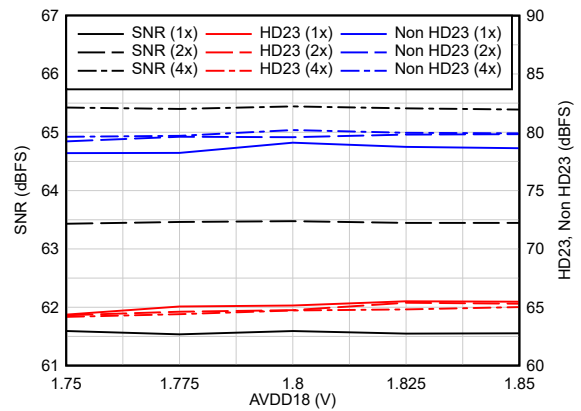

$F_{IN} = 900\text{ MHz}$, $A_{IN} = -1\text{ dBFS}$, Dither = DIS, Other supplies nominal

Figure 6-87. AC Performance vs AVDD18

6.13 Typical Characteristics - ADC32RF55 (continued)

Typical values are at $T_A = 25^\circ\text{C}$, ADC sampling rate = 3 GSPS, LMFS = 82820, 50% clock duty cycle, AVDD18 = 1.8 V, AVDD12, CLKVDD, DVDD = 1.2 V and -1-dBFS differential input, unless otherwise noted

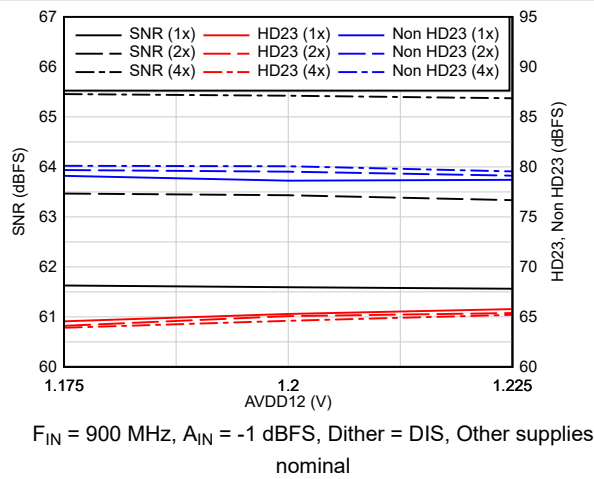

Figure 6-88. AC Performance vs AVDD12

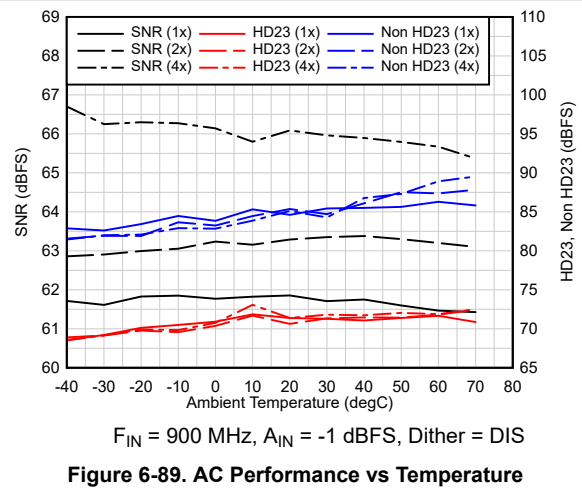

Figure 6-89. AC Performance vs Temperature

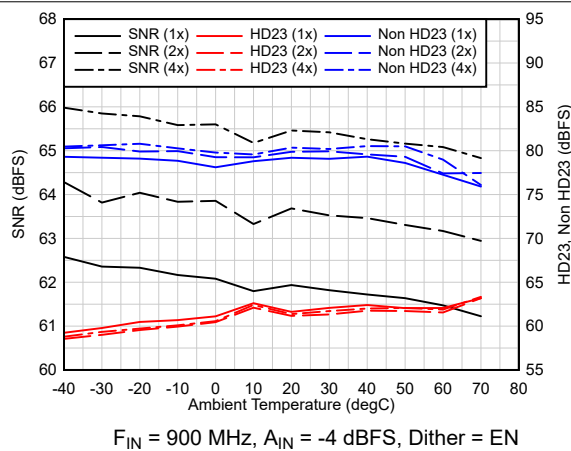

Figure 6-90. AC Performance vs Temperature

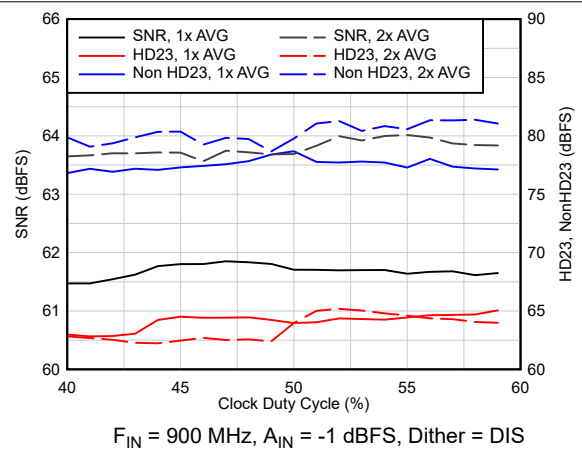

Figure 6-91. AC Performance vs Clock Duty Cycle

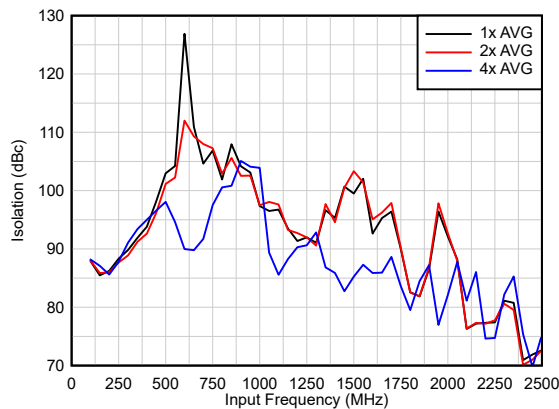

Figure 6-92. Isolation vs Input Frequency

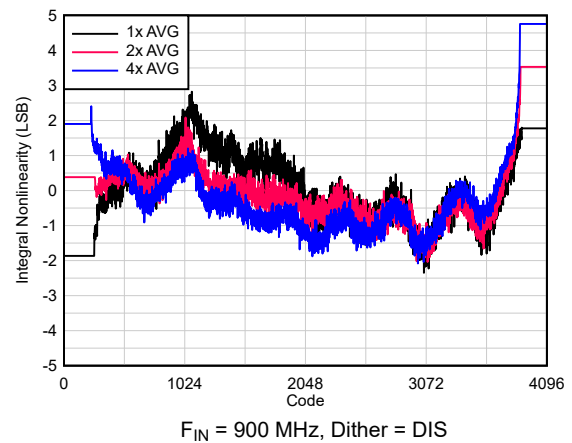
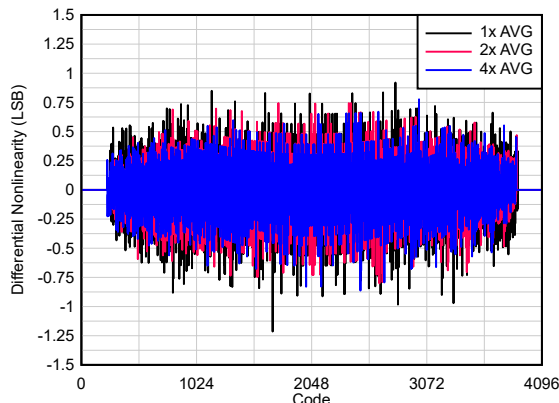

Figure 6-93. INL vs Code

6.13 Typical Characteristics - ADC32RF55 (continued)

Typical values are at $T_A = 25^\circ\text{C}$, ADC sampling rate = 3 GSPS, LMFS = 82820, 50% clock duty cycle, AVDD18 = 1.8 V, AVDD12, CLKVDD, DVDD = 1.2 V and -1-dBFS differential input, unless otherwise noted



$F_{IN} = 900\text{ MHz}$, Dither = DIS

Figure 6-94. DNL vs Code

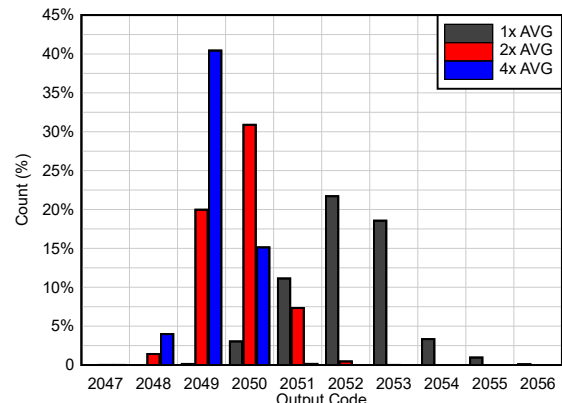

Dither = DIS

Figure 6-95. DC Offset Histogram

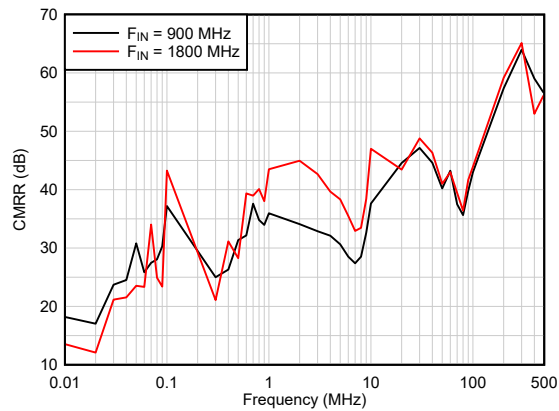

$A_{IN} = -1\text{ dBFS}$, 1x AVG, Dither = DIS

Figure 6-96. CMRR

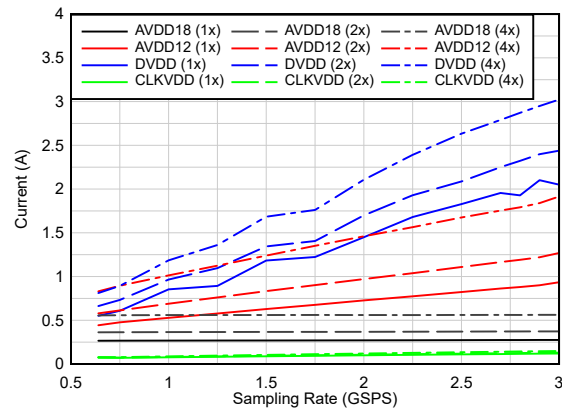

$A_{IN} = -1\text{ dBFS}$, Dither = DIS, DDC Bypass

Figure 6-97. Current vs Sampling Rate vs Averaging

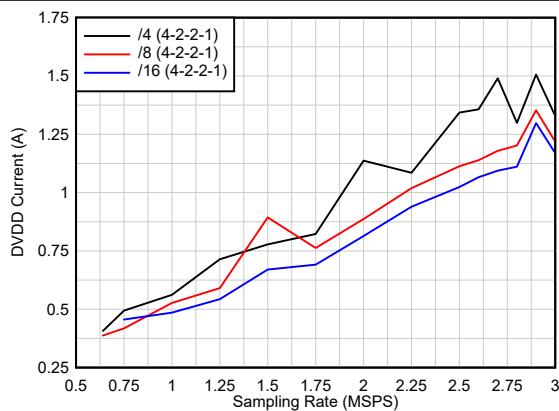

$A_{IN} = -1\text{ dBFS}$, 1x AVG

Figure 6-98. Current vs Sampling Rate vs Real Decimation

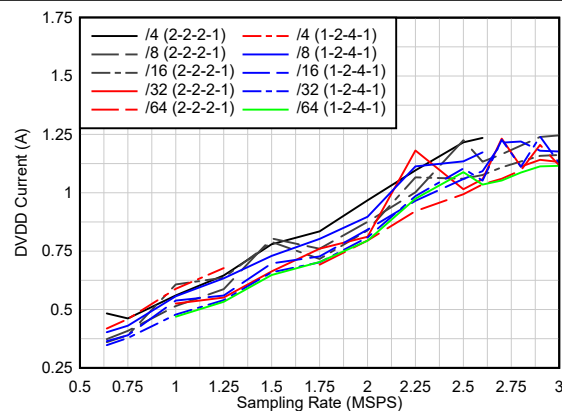

$A_{IN} = -1\text{ dBFS}$, 1x AVG

Figure 6-99. Current vs Sampling Rate vs Real Decimation

6.13 Typical Characteristics - ADC32RF55 (continued)

Typical values are at $T_A = 25^\circ\text{C}$, ADC sampling rate = 3 GSPS, LMFS = 82820, 50% clock duty cycle, AVDD18 = 1.8 V, AVDD12, CLKVDD, DVDD = 1.2 V and -1-dBFS differential input, unless otherwise noted

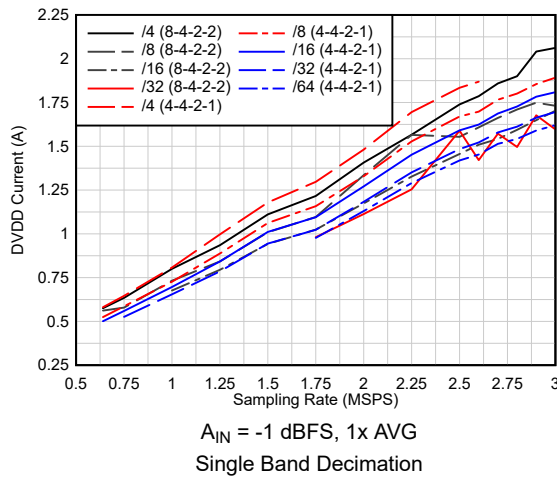

Figure 6-100. Current vs Sampling Rate vs Complex Decimation

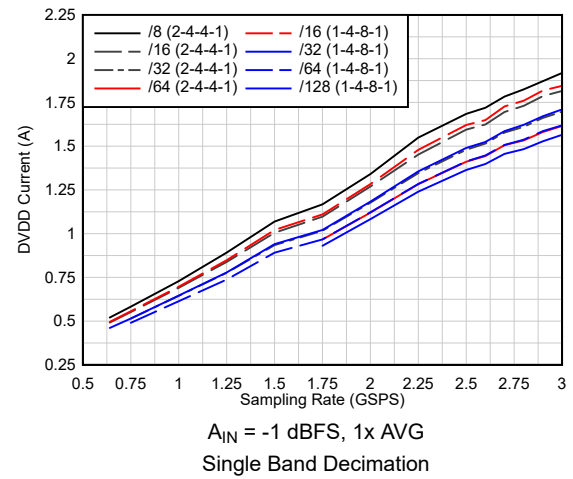

Figure 6-101. Current vs Sampling Rate vs Complex Decimation

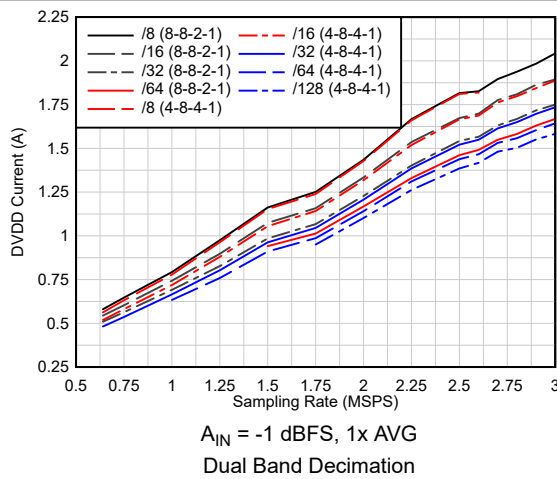

Figure 6-102. Current vs Sampling Rate vs Complex Decimation

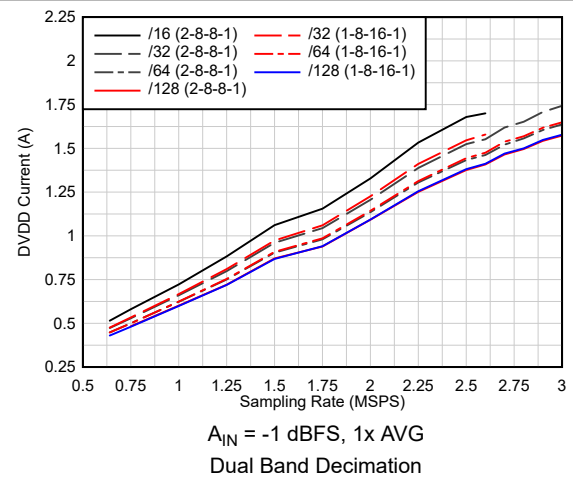

Figure 6-103. Current vs Sampling Rate vs Complex Decimation

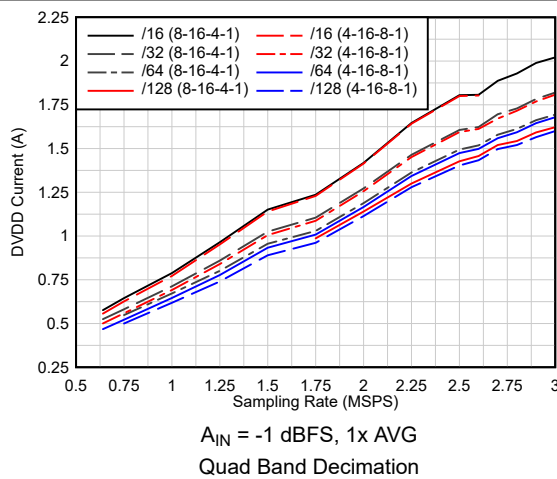

Figure 6-104. Current vs Sampling Rate vs Complex Decimation

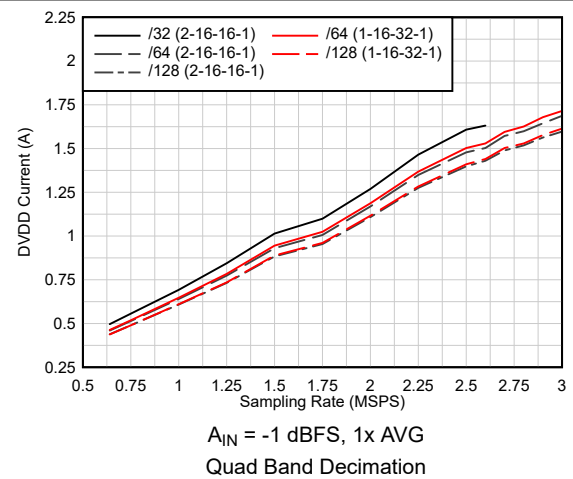
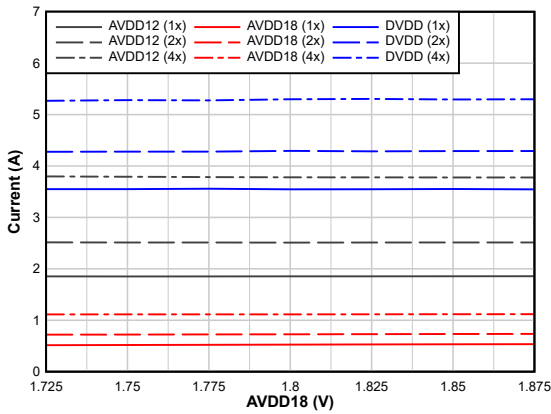

Figure 6-105. Current vs Sampling Rate vs Complex Decimation

6.13 Typical Characteristics - ADC32RF55 (continued)

Typical values are at $T_A = 25^\circ\text{C}$, ADC sampling rate = 3 GSPS, LMFS = 82820, 50% clock duty cycle, AVDD18 = 1.8 V, AVDD12, CLKVDD, DVDD = 1.2 V and -1-dBFS differential input, unless otherwise noted



$A_{IN} = -1$ dBFS, DDC Bypass

Figure 6-106. I_{AVDD18} vs Supply

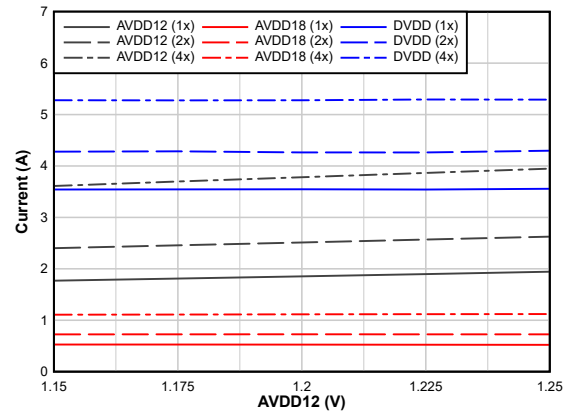

$A_{IN} = -1$ dBFS, DDC Bypass

Figure 6-107. I_{AVDD12} vs Supply

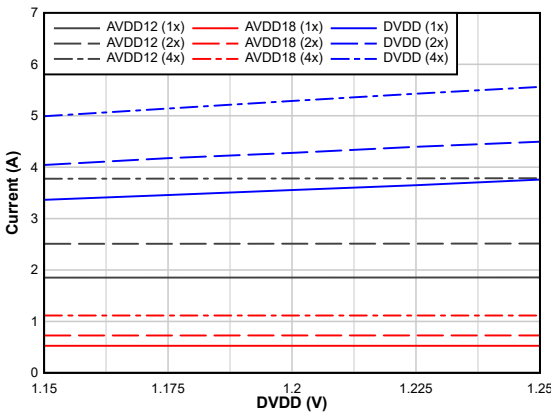

$A_{IN} = -1$ dBFS, DDC Bypass

Figure 6-108. I_{DVDD} vs Supply

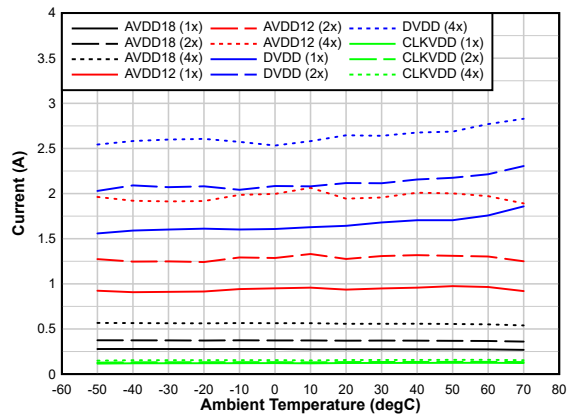

$A_{IN} = -1$ dBFS, DDC Bypass

Figure 6-109. Current vs Temperature

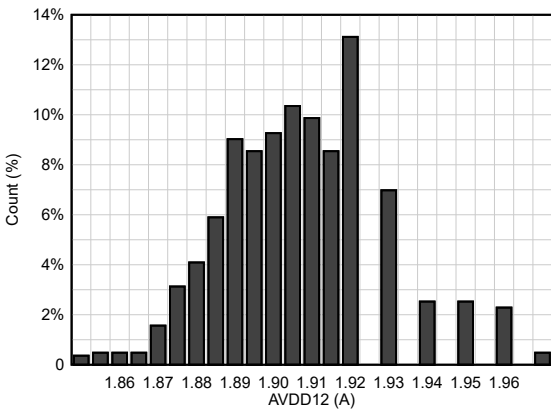

$A_{IN} = -1$ dBFS, DDC Bypass

Figure 6-110. AVDD12 Distribution

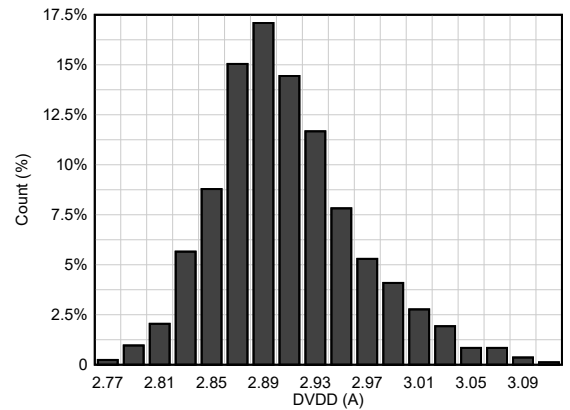

$A_{IN} = -1$ dBFS, DDC Bypass

Figure 6-111. DVDD Distribution

7 Detailed Description

7.1 Overview

The ADC32RF5x is a single core (non-interleaved) 14-bit, 2.6 GSPS to 3 GSPS, dual channel analog to digital converter (ADC). The design maximizes signal-to-noise ratio (SNR) and delivers a noise spectral density of -155 dBFS/Hz. Additional internal ADCs can be used for on-chip averaging (2x and 4x) to further improve the noise density to as low as -161 dBFS/Hz.

The analog signal input is non-buffered to save power consumption with a nominal differential input impedance of 100 Ω. The full power input bandwidth is 2.75 GHz (-3 dB) and the device supports direct RF sampling with input frequencies in the through the L-band. The device is designed for low residual phase noise to support high performance radar applications. The sampling clock input has a dedicated power supply input which requires a very clean power supply.

Each ADC channel can be connected to a quad-band digital down-converter (DDC) using a 48-bit NCO which supports phase coherent frequency hopping. Using the GPIO pins for NCO frequency control, frequency hopping can be achieved in less than 1 μs. The digital down converters support a wide range of instantaneous bandwidth (IBW) coverage - from single wide band mode with 4x complex decimation to up to four narrow bandwidth channels with as high as 128x complex decimation.

The ADC32RF5x supports the JESD204B serial data interface with subclass 1 deterministic latency using data rates up to 13.0 Gbps. In bypass mode, 14-bit output is supported up to a sampling rate of 2.6 Gsps. From 2.6 to 3 Gsps a 12-bit interface with more efficient data packing can be used at expense of quantization noise. When using decimation the output is 16-bit.

7.2 Functional Block Diagram

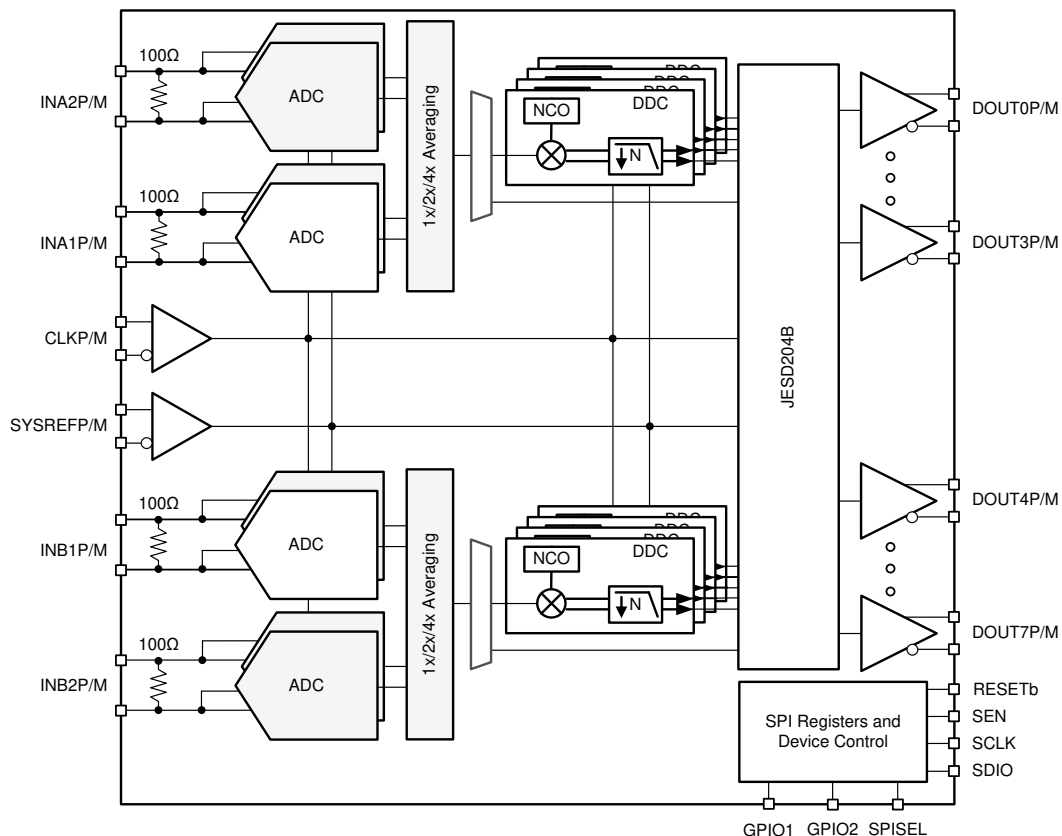

7.3 Feature Description

7.3.1 Analog Inputs

The ADC32RF5x provides up to four internal ADCs per channel for purpose of averaging in order to improve the noise performance. Two ADCs internally are connected to the same differential input pins as shown in the equivalent input schematic (see Figure 7-1). The analog inputs have a differential 100 Ω split termination with internal biasing. This can be changed to differential 50 Ω termination via SPI register write. When only a single ADC is used, there is a minor parasitic capacitance remaining from the unused ADC.

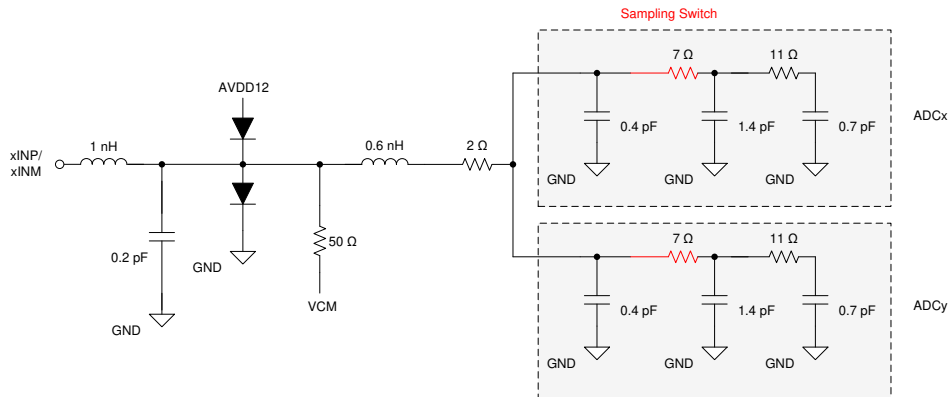

Figure 7-1. Equivalent Input Schematic

7.3.1.1 Input Bandwidth and Full-Scale

The input bandwidth (-3 dB) and input fullscale are dependent on what input termination and averaging mode are chosen as shown in the summary in Table 7-1. With 4x averaging enabled, the -3 dB bandwidth reduces to ~ 2.1 GHz and 100 Ω differential termination - the bandwidth can be increased by changing the input termination to 50 Ω differential.

Table 7-1. Digital averaging vs Full Power Input Bandwidth (-3 dB)

# of ADCs averaged	ADC inputs used for averaging	Input Bandwidth (-3 dB)	Selected differential input termination	Effective differential input termination	Input Full-scale
Default	INx1	2.75 GHz	100 Ω	100 Ω	+ 2 dBm
2	INx1	2.75 GHz	100 Ω	100 Ω	+ 3.5 dBm
4	INx1, INx2	2.1 GHz	100 Ω	50 Ω	+ 6.6 dBm

The full power input bandwidth plots with input RESET switch disabled (RSW0) and enabled (RSW1) are shown in Figure 7-2.

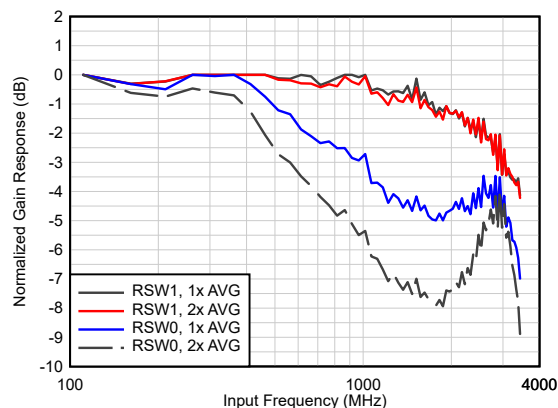

Figure 7-2. Input Bandwidth - Reset switch DIS

The RESET switch is enabled by default and can be disabled with the following register writes:

Table 7-2. Register Write Example for Configuring the Internal Dither

ADDR	DATA	DESCRIPTION
0x05	0x40	Select ANALOG page
0x6D	0xC0	Disable RESET Switch (to enable: 0x00)
0x6E	0x03	Disable RESET Switch (to enable: 0x00)

7.3.1.2 Input Imbalance

The AC performance is sensitive to amplitude and phase imbalance of the analog inputs, as shown in Figure 7-3 and Figure 7-4 for 1x and 2x internal averaging ($F_S = 2.6$ GSPS, $F_{IN} = 0.9$ GHz, $A_{IN} = -1$ dBFS, dither = DIS) and Figure 7-5 and Figure 7-6 ($F_S = 3.0$ GSPS, $F_{IN} = 0.9$ GHz, $A_{IN} = -1$ dBFS, dither = DIS).

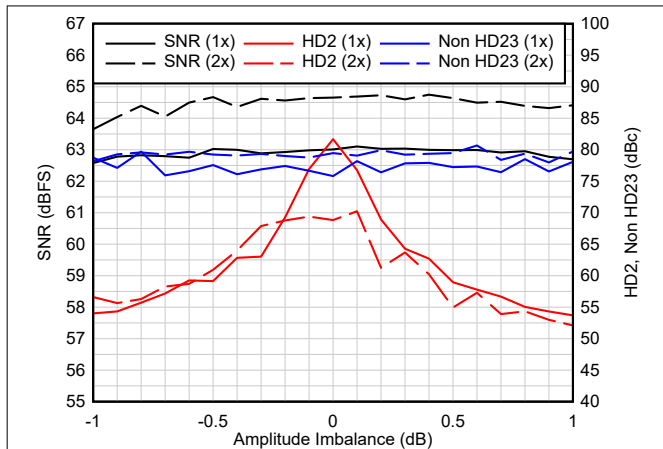

Figure 7-3. Amplitude Imbalance - 2.6 GSPS

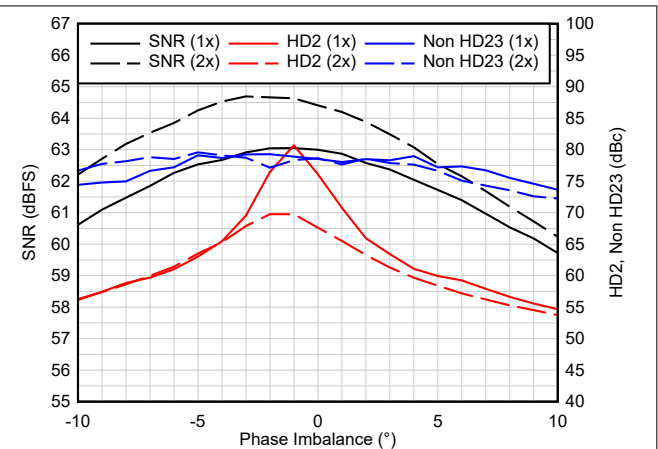

Figure 7-4. Phase Imbalance - 2.6 GSPS

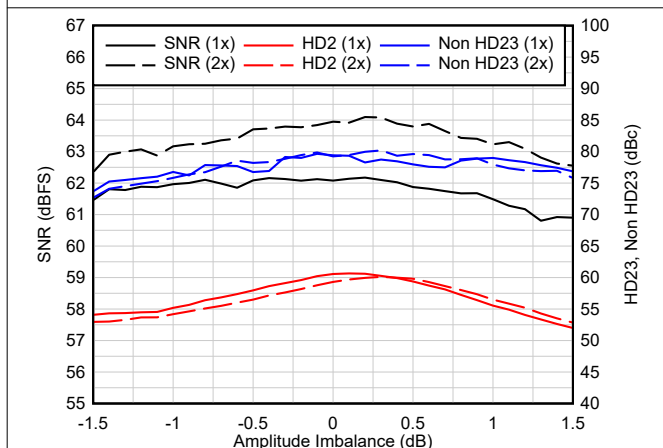

Figure 7-5. Amplitude Imbalance - 3.0 GSPS

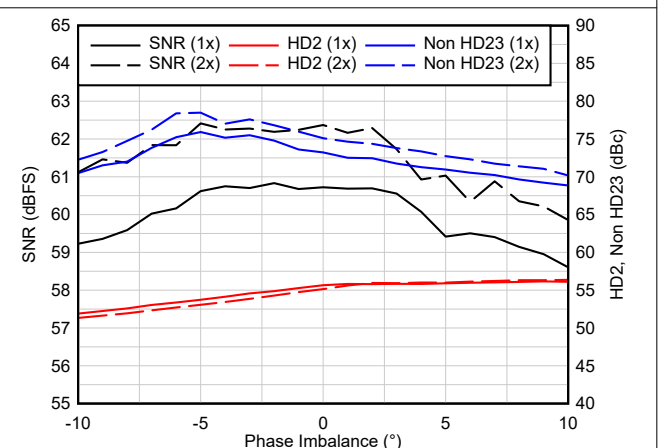

Figure 7-6. Phase Imbalance - 3.0 GSPS

7.3.1.3 Overrange Indication

The ADC provides two options (configured using SPI) to indicate if input fullscale overrange occurred:

- Fast Overrange on GPIO1/2 pins: indication is available after ~ 6 clock cycles and the overrange indication flag stays high (sticky) until it is cleared via SPI register writes. Note: OVRA and OVRB or OR-ed together and given on GPIO1 and 2.
- Overrange embedded in JESD stream: in this configuration the overrange indicator replaces the LSB of the output data of the corresponding channel. The indicator is output ahead of the data and is updated every clock cycle.

Table 7-3. JESD OVR Latency

Decimation	# of Bands	OVR Latency (incl JESD, in sampling clock cycles)
DDC Bypass	-	140-144
8	Single (real and complex), dual	44
	Quad	33
16	Single (real and complex), dual	80
	Quad	58
32	Single (real and complex), dual	152
	Quad	108
64	Single (real and complex), dual	296
	Quad	208
128	Single (real and complex), dual	584
	Quad	408

The overrange output flag (GPIO or JESD) is the output of individual overrange flags of all ADCs per channel being used. For example, in non-averaged mode the overrange indication per channel is for a single ADC while in 4x average mode the overrange flag of all 4 ADCs are OR-ed together. [Table 7-4](#) shows how to configure the OVR using SPI registers.

Table 7-4. Programming example to configure the OVR to GPIO or JESD

ADDR	DATA	DESCRIPTION	ADDR	DATA	DESCRIPTION
OVR on GPIO1 and GPIO2, OVR sticky			OVR on JESD		
0x05	0x40	Select ANALOG page	0x05	0x02	Select DIGITAL page
0xB7	0x00/01	0x00 chA, 0x01 chB	0x2E	D0	Set D0 = 1 to enable OVR on JESD
0x05	0x02	Select DIGITAL page	0x05	0x00	
0x237	0x05	Configures GPIO pins as outputs	These extra writes are only needed using decimation		
0x238	0xF0		0x05	0x18	Select DDCA/B page
Clear OVR			0x20	0x06	Enable OVR on JESD
0x05	0x40	Select ANALOG page			
0x74	0x04	Clear OVR flag chA			
0x74	0x00				
0x84	0x04	Clear OVR flag chB			
0x84	0x00				
Change OVR from sticky to non sticky (self clear)					
0x05	0x40	Select ANALOG page			
0x31	0x26	Set OVR to non-sticky			

7.3.1.4 Analog out-of-band dither

The ADC32RF5x provides optional (enabled via SPI writes) analog out-of-band, large amplitude dither. It has a bandwidth of ~ 20 MHz located at DC and an adjustable amplitude with a maximum dither power of ~ -20 dBFS (PAR ~ 9 dB). The dither is completely rolled-off into the noise floor within ~ 100 MHz as illustrated in Figure 7-7. Since the dither is large amplitude, it is recommended for the signal input not to exceed -2.5 dBFS to avoid input saturation. The dither signal also couples to the input signal and, depending on input frequency, can degrade the close in phase noise.

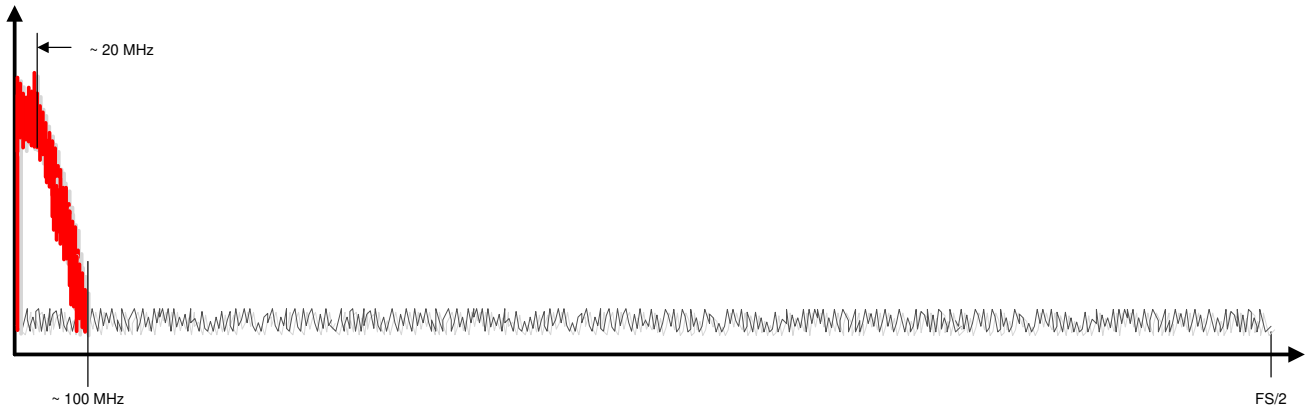

Figure 7-7. Analog out-of-band dither

In the frequency domain the dither signal shows up like individual tones as shown in Figure 7-8. The dither update frequency can be adjusted with the dither divider setting. The dither update frequency is: $F_S / 4 / 2047 / \text{'Dither Divider'}$. In the frequency spectrum there will be 2 larger dither spurs at $F_{IN} \pm F_S / 4 / \text{'Dither Divider'}$.

By default, the divider is set to 50, which translates to a dither spur spacing of ~ 7 kHz. A divider setting of 32 translates to a dither spacing of ~ 11 kHz as shown in Figure 7-9. The lower the divider setting, the higher the dither tone frequency. Figure 7-9 also shows that the dither energy reduces as the offset frequency increases - less dither energy reduces the higher harmonic spur improvement.

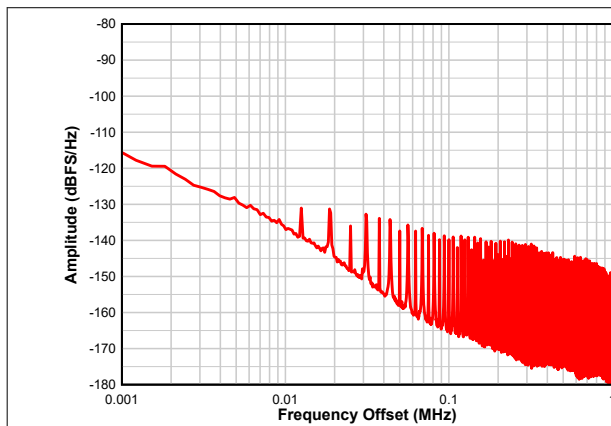

Figure 7-8. Dither Close-Up

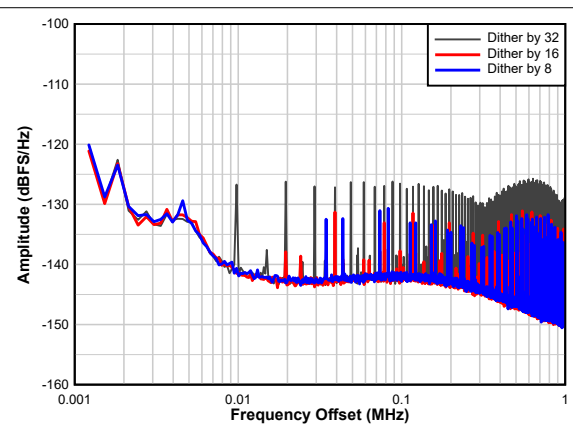

Figure 7-9. Dither vs Dither Divider Setting

The analog dither needs to be enabled in multiple locations. Different dither amplitudes should be used depending on internal averaging used as shown in [Table 7-5](#).

Table 7-5. Recommended Dither Amplitude Settings

Mode	Amplitude	Dither Amp1	Dither Amp2
1x AVG	+/-1024 codes	0	0
1x AVG	+/-768 codes	0	-4
2x/4x AVG	+/-1024 codes	3	0
2x/4x AVG	+/-768 codes	0	0

The internal analog dither can be enabled via the following register writes. The dither divider is set in register 0xB1 as actual -1 (e.g. a divider of 48 would be programmed as 47, default is 0x00 which is divider = 50). See [Table 7-6](#).

Table 7-6. Register Write Example for Configuring the Internal Dither

ADDR	DATA	DESCRIPTION	ADDR	DATA	DESCRIPTION
0x05	0x40	Select ANALOG page	0xB1	0x00	Sets dither divider. 0x00 = /50
0xA8	0x00	DITHER AMP1: 3 = 0x80, 0 = 0x00	0xB2	0x00	
0xCD	0x00	DITHER AMP2: -4 = 0x40, 0 = 0x00	0xAF	0x18	
0x04	0x01		0xAF	0x10	0x10 = dither ENABLED, 0x90 = dither DISABLED
0x20	0x04		0x04	0x01	
0x91	0x40		0x20	0x00	
0xAF	0x10		0x04	0x00	

7.3.2 Sampling Clock Input

The internal sampling clock path was designed for lowest residual phase noise contribution. The sampling clock circuitry requires a dedicated low noise power supply for best performance. The internal residual clock phase noise is also sensitive to clock amplitude. For best performance, the clock amplitude should be larger than 1 V_{pp}. The phase noise ideally improves by 3 dB per 2x averaging, however at higher input frequencies the clock path contribution reduces the improvement.

Table 7-7. Internal Aperture Clock Phase Noise
(F_S = 3 Gsps, V_{IN} = 1 V_{pp})

Frequency Offset (MHz)	Amplitude (dBc/Hz)
0.001	-117
0.01	-127
0.1	-137
1	-147
10	-154
250	-160

The clock input and ADC sampling circuitry also have an amplitude noise component which modulates on to the sampled input signal. Unlike phase noise, the amplitude noise doesn't scale with input frequency, it is only affected by the sampling reset switch as shown in Figure 7-10 and Figure 7-11. This noise component can dominate the close in noise performance at lower input frequencies.

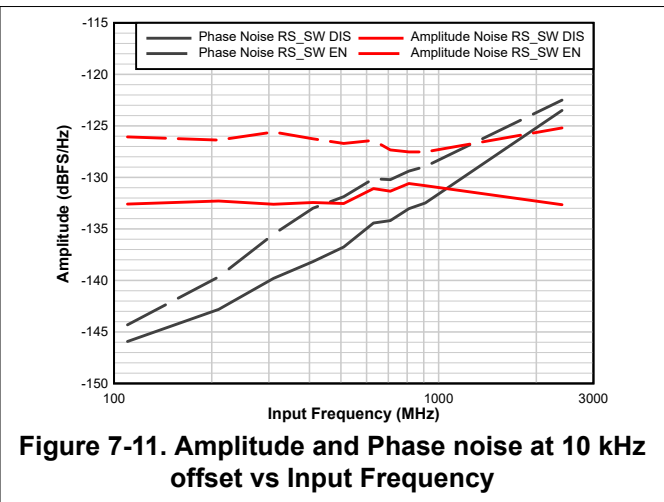
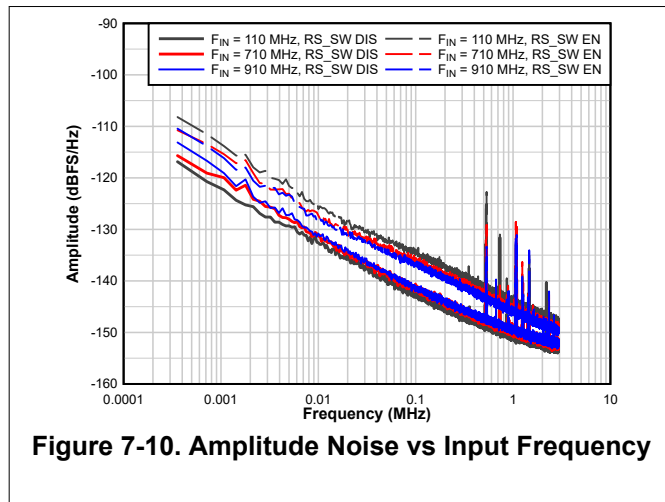

The internal aperture jitter is also dependent on the amplitude of the external clock input signal. [Figure 7-12](#) and [Figure 7-13](#) show the expected SNR performance with dither on/off across clock amplitude ($F_S = 2.6$ GSPS).

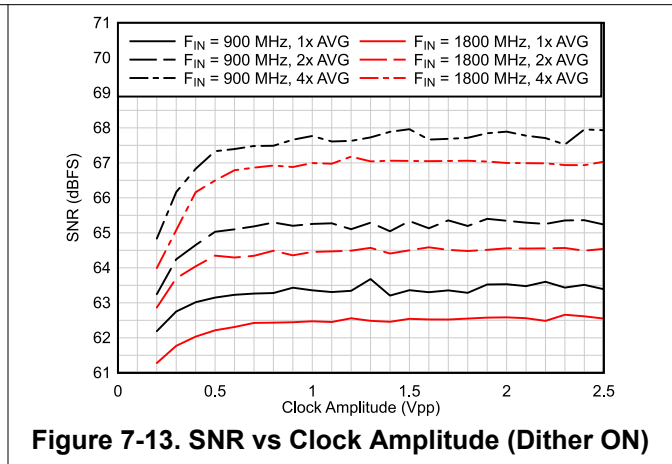
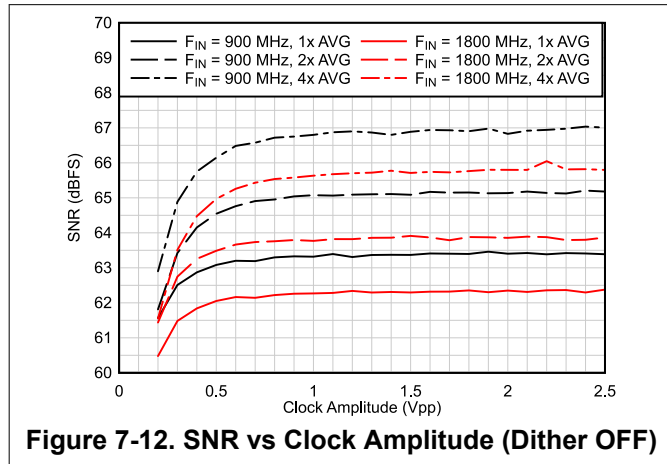

The sampling clock input is internally terminated to $100\ \Omega$ differentially and provides a return loss better than 10 dB at 3 GHz (see [Figure 7-14](#)). The clock input consists of a single clock input buffer followed by a dedicated clock buffer for ADCA1/2 as well as ADCB1/2. When averaging multiple ADCs, there are some close in clock buffer noise which is correlated; and thus, does not improve with averaging.

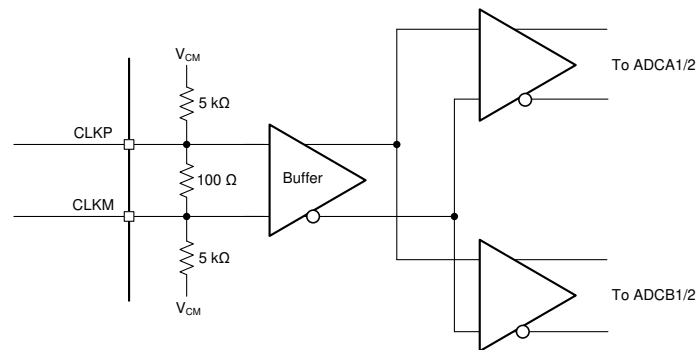

Figure 7-14. Internal Clock Input Routing

7.3.3 SYSREF

The SYSREF input signal is used to reset internal digital blocks and align them to the internal multi-frame clock in order to achieve deterministic latency subclass 1. The SYSREF input signal can be AC or DC coupled (selected via SPI register option) as shown in Figure 7-15. The ADC32RF5x has internal 100-Ω termination for DC coupling and internal biasing when using AC coupling.

A register mask can be used to only give SYSREF to the NCO (see NCO section) in the decimation filter block, and leave all other blocks such as JESD interface unaffected.

When giving a periodic SYSREF signal, its frequency is required to be a sub-harmonic of the internal local multi-frame clock (LMFC). The LMFC frequency is determined by the selected decimation, frames per multi-frame setting (K), samples per frame (S) and the device sampling frequency (FS).

Table 7-8. LMFC and SYSREF settings for different operating modes

Operating Mode	LMFS Mode	LMFC Clock Frequency	SYSREF Frequency
DDC Bypass Mode	82820	$FS / (20 * K)$	$FS / (N * 20 * K)$
	8224	$FS / (4 * K)$	$FS / (N * 4 * K)$
Decimation	Various	$FS / (D * S * K)$	$FS / (N * D * S * K)$

where N is an integer value (1, 2, 3...)

After enabling SYSREF input, the internal SYSREF input ignores any incoming SYSREF pulse after the first 16 pulses.

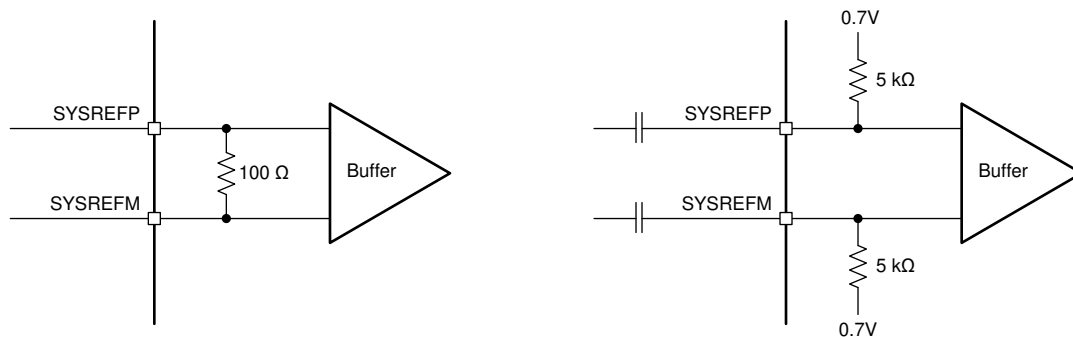

Figure 7-15. SYSREF Input Circuitry and Edge Alignment

The internal synchronization using the external SYSREF signal can be enabled with the following register writes (see Table 7-9)

Table 7-9. Register Write Example for Enabling SYSREF Synchronization

ADDR	DATA	DESCRIPTION
0x05	0x02	Select DIGITAL page
0x236	0x02	Enable internal SYSREF input and clear SYSREF pulse counter
0x236	0x03	Starts internal SYSREF counter

AC coupling with internal biasing of the SYSREF input can be enabled with the following SPI register writes (see Table 7-10)

Table 7-10. Register Write Example for Enabling SYSREF AC Coupling

ADDR	DATA	DESCRIPTION
0x05	0x40	Select ANALOG page
0xB4	0x01	Enable external AC coupling with internal biasing on SYSREF

7.3.3.1 SYSREF Capture Detection

The SYSREF input signal rising edge should be edge aligned with the rising edge of the sampling clock in order to maximize the setup and hold times. The ADC32RF5x includes an internal SYSREF monitoring circuitry to detect possible metastability resulting in a clock cycle slip; and thus, misalignment across devices.

The sampling clock gets delayed by ~160 ps and then captures the SYSREF signal. The SYSREF monitoring circuitry captures the SYSREF signal ±50 ps (-50, -25, +16, +32, +48 ps) around the main SYSREF capture. In ideal conditions no SYSREF transition happens within the 100 ps SYSREF capture window and all XOR flags show "0". If a SYSREF/clock misalignment happens and the SYSREF transition falls within the SYSREF monitoring window, then one of the XOR flags (which monitor adjacent SYSREF captures within the window) shows a "1" and the SYSREF can be adjusted externally.

The SYSREF monitor registers are not *sticky* registers, which are updated at every rising edge of SYSREF.

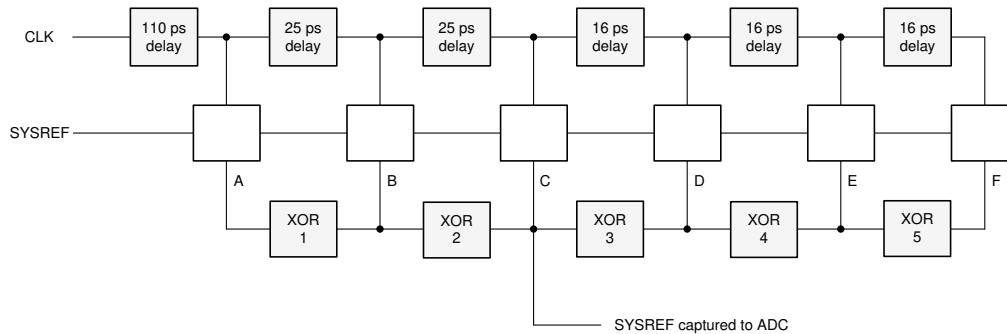

Figure 7-16. SYSREF Detection Circuitry

Figure 7-17 shows a misaligned SYSREF signal where the SYSREF signal arrives much later than the sampling clock rising edge. The SYSREF window feature checks if the SYSREF transition is within ±50 ps of the instant when the SYSREF signal gets captured by the sampling clock.

In this example, the delayed SYSREF signal transitions between the "B" and "C" flip flop which raises the XOR2 flag. The XOR flags get reported in register 0x22F in the digital page. In this example, Register 0x22F reads back 0x8B, as shown in Table 7-11.

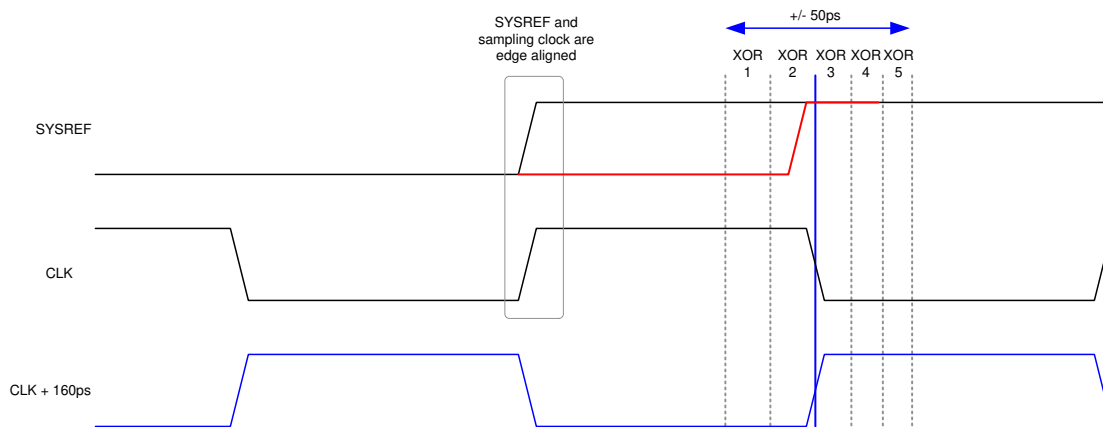

Figure 7-17. Detection of SYSREF Transition Within Capture Window

Table 7-11. SYSREF Window Register Example (0x22F)

ADDR	D7	D6	D5	D4	D3	D2	D1	D0
0x22F	1	SYSREF X5	SYSREF X4	SYSREF X3	SYSREF X2	SYSREF X1	SYSREF OR	1
	1	0	0	0	1	0	1	1

7.3.4 ADC Foreground Calibration

The internal ADC architecture is sensitive to temperature changes. The devices contains two additional internal ADC cores. One for channel A1/2, and one for channel B1/2 which are used when one of the ADCs is in calibration. The ADCs are calibrated as pairs where one ADC at a time is connected to the internal calibration DAC. The calibration is configured via SPI register writes and can be executed using SPI register writes or using the GPIO1 pin. When executed, the calibration takes ~ 27 ms/ADC pair (~13.5 ms/ADC). The example in [Figure 7-18](#) shows 2x internal averaging where 4 ADC cores (#1, #2 for chA1 and #6, #7 for chB1) are used in operation and ADCs #5 and #10 for calibration.

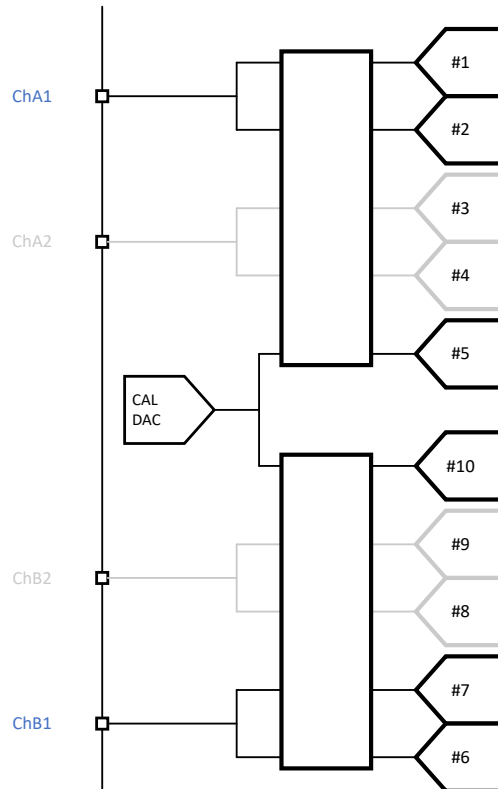

Figure 7-18. Internal ADC setup for 2x averaging mode

7.3.4.1 Calibration Control

Figure 7-19 shows a timing diagram of the calibration control using GPIO1 pin.

When GPIO1 transitions to LOW logic state:

- an ADC pair gets swapped out within ~ 120 ns
- a new calibration gets triggered immediately

If GPIO1 is being held low when the calibration of an ADC pair is completed, the next ADC pair is switched and a new calibration is triggered. The order in which ADC pair gets calibrated can be configured via SPI to serial or random.

When using 2x averaging for example, the calibration should be executed for 3 ADC pairs to ensure all ADCs in use have been calibrated recently.

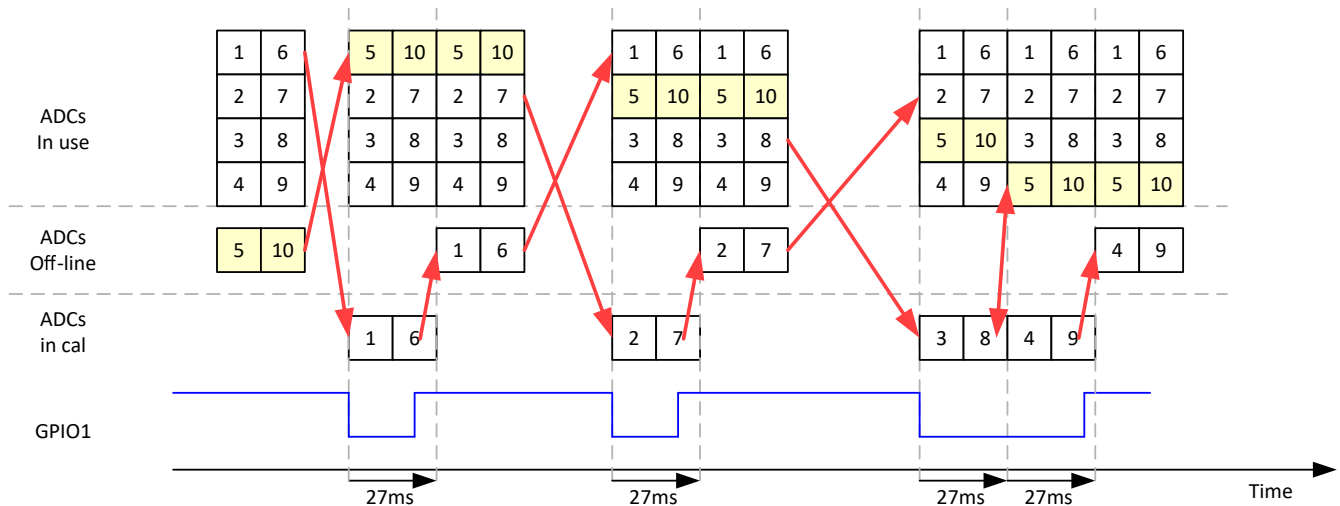

Figure 7-19. Timing Diagram - Calibration (4x AVG Example)

Figure 7-20 shows the ADC switch happens approximate 120 ns after the logic level change on GPIO1 is detected.

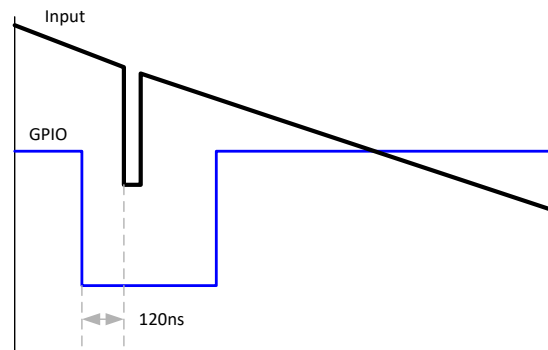

Figure 7-20. Timing diagram shows the ADC switch

7.3.4.2 ADC Switch

During the ADC transition, the amplitude may drop less 1% for 1-2 samples as shown in [Figure 7-21](#). The gain variation from one ADC to the next is $\sim < 0.05$ dB while the phase change is less 0.01 deg as shown in [Figure 7-22](#).

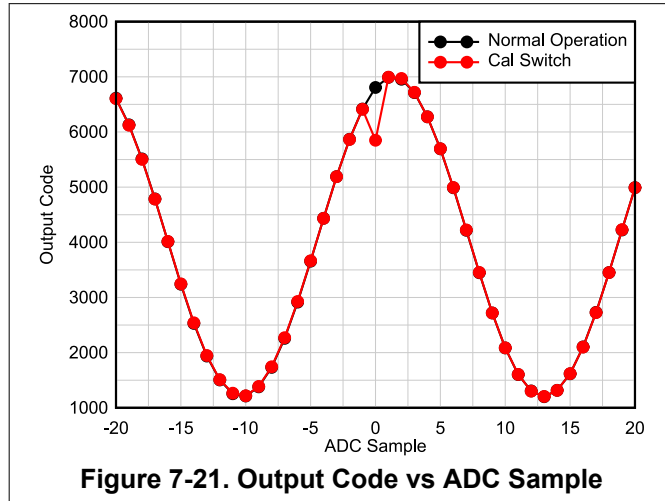

Figure 7-21. Output Code vs ADC Sample

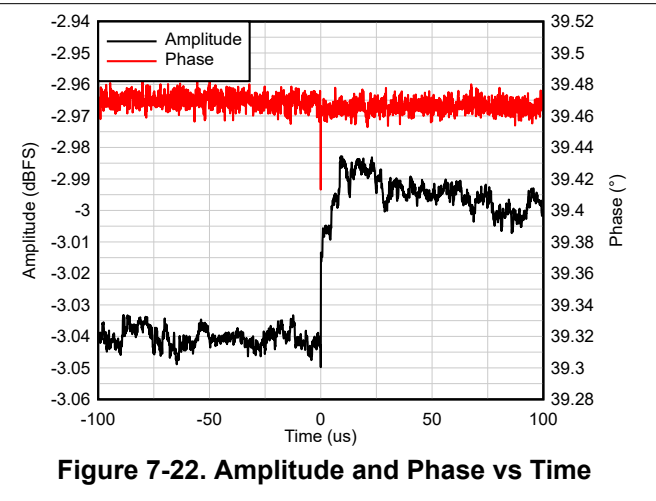

Figure 7-22. Amplitude and Phase vs Time

7.3.4.3 Calibration Configuration

The ADC32RF5x provides 3 different options to configure the internal foreground calibration:

- Continuous calibration - see [Table 7-12](#)
- Calibrate all ADCs one time using SPI trigger - see [Table 7-13](#)
- Calibrate 2 ADC pairs at a time using GPIO trigger - see [Table 7-14](#)

The status of the calibration can be read back from register 0x298 (CALIBRATION page). Successful calibration reads back 0x0E.

Table 7-12. Register Writes to Trigger CONTINUOUS Calibration of all ADCs Using SPI

ADDR	DATA	DESCRIPTION
0x05	0x20	Select CALIBRATION page
0x46	0x03	

Table 7-13. Register Writes to Trigger SINGLE Calibration of all ADCs Using SPI

ADDR	DATA	DESCRIPTION
0x05	0x20	Select CALIBRATION page
0x48	0x15	
0x45	0x8A	Toggle calibration start
0x45	0x0A	
		wait 2 s

Table 7-14. Register Writes to Trigger ADC Pair Calibration Using the GPIO Pin

ADDR	DATA	DESCRIPTION
0x05	0x20	Select CALIBRATION page
0x46	0x02	
0x45	0x4A	
0x05	0x02	Select DIGITAL page
0x234	0x04	Use GPIO1 pin to freeze calibration switch

7.3.5 Decimation Filter

The ADC32RF5x provides up to four digital down converters per ADC channel, see [Figure 7-23](#). The decimation filters provide a flexible option to cover a wide range of instantaneous bandwidths (IBW) as shown in [Table 7-15](#). Single band decimation supports a wide bandwidth up to complex decimation by 4x while up to four narrow band channels with up to 128x complex decimation are supported in quad band decimation mode.

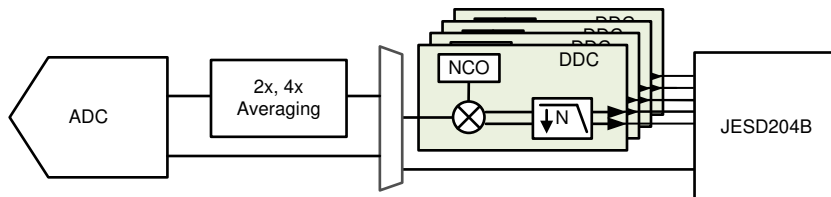

Figure 7-23. Digital Decimation Filter Options

Table 7-15. Summary of Different Decimation Filter Band Options

# of DDCs	Minimum Complex Decimation	Maximum Complex Decimation
1	4	128
2	8	128
4	16	128

The decimation filter can be configured to two different operating modes:

- **Complex Decimation:** This mode provides complex output with ~ 80% passband bandwidth using a 48-bit phase coherent NCO.
During the complex mixing operation the digital output is reduced by 6-dB. This reduces the fullscale from 0-dBFS to -6-dBFS. This 6-dB change applies to signals and noise and thus no dynamic range is lost.
- **Real Decimation:** In real decimation mode, the complex mixer is bypassed (NCO is set to 0 for lowest power consumption), and the digital filter acts as a low pass filter. There is no frequency shifting and the output passband bandwidth is ~ 40%.

Since the JESD204B interface is common across ADC channel A and B, the decimation ratio as well as the # of DDCs/ADC has to be the same across channels A and B.

By default, the output of values of the decimation filter are rounded to 16-bit resolution. In order to avoid quantization noise limitation when using high order of decimation (that is /64 or /128), a special 20-bit output mode can be enabled (see [20-bit Output Mode](#)).

[Table 7-16](#) provides an overview of the available complex decimation settings and resulting complex and real output bandwidths.

Table 7-16. Complex Decimation Setting vs Output Bandwidth

Decimation Factor N (complex)	Complex Output Bandwidth per DDC	$F_S = 3 \text{ Gsps}$		Real Output Bandwidth per DDC	$F_S = 3 \text{ Gsps}$	
		Complex Output Rate per DDC	Complex Output Bandwidth per DDC		Real Output Rate per DDC	Real Output Bandwidth per DDC
4	$0.8 \times F_S / 4$	750 Msps	600 MHz	$0.4 \times F_S / 4$	750 Msps	300 MHz
8	$0.8 \times F_S / 8$	375 Msps	300 MHz	$0.4 \times F_S / 8$	375 Msps	150 MHz
16	$0.8 \times F_S / 16$	187.5 Msps	150 MHz	$0.4 \times F_S / 16$	187.5 Msps	75 MHz
32	$0.8 \times F_S / 32$	93.75 Msps	75 MHz	$0.4 \times F_S / 32$	93.75 Msps	37.5 MHz
64	$0.8 \times F_S / 64$	46.875 Msps	37.5 MHz	$0.4 \times F_S / 64$	46.875 Msps	18.75 MHz
128	$0.8 \times F_S / 128$	23.4375 Msps	18.75 MHz	$0.4 \times F_S / 128$	23.4375 Msps	9.375 MHz

7.3.5.1 Decimation Filter Response

This section provides the different decimation filter responses with a normalized ADC sampling rate. The complex filter pass band is ~ 80% (-1 dB) with a minimum of 85 dB stop band rejection.

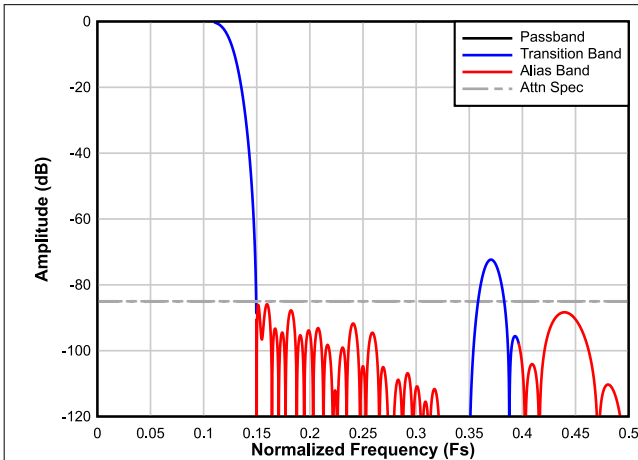

Figure 7-24. Complex Decimation by 4 Filter Response

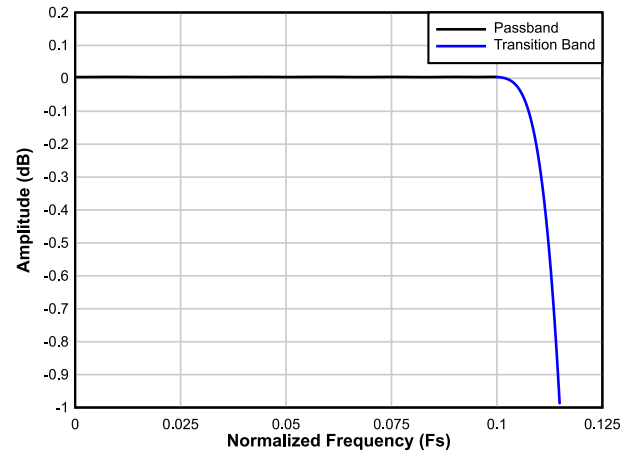

Figure 7-25. Decimation by 4 Passband Ripple Response

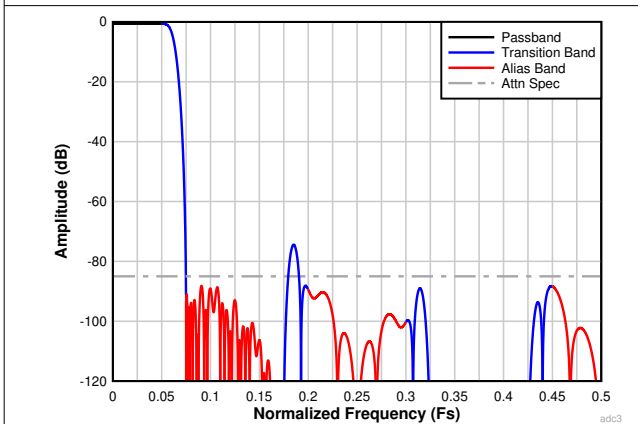

Figure 7-26. Complex Decimation by 8 Filter Response

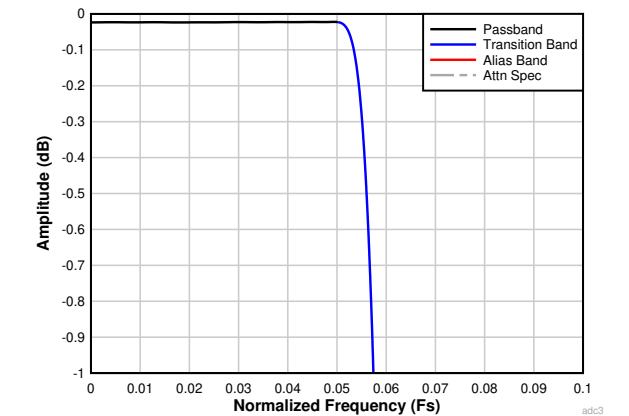

Figure 7-27. Decimation by 8 Passband Ripple Response

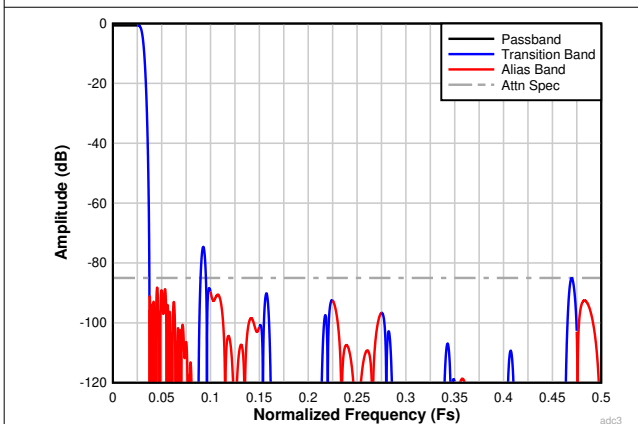

Figure 7-28. Complex Decimation by 16 Filter Response

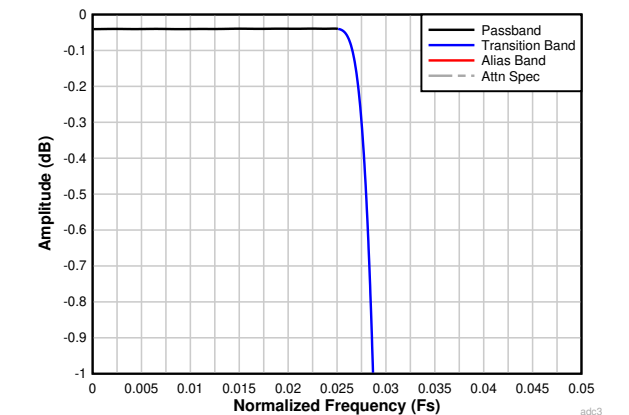

Figure 7-29. Decimation by 16 Passband Ripple Response

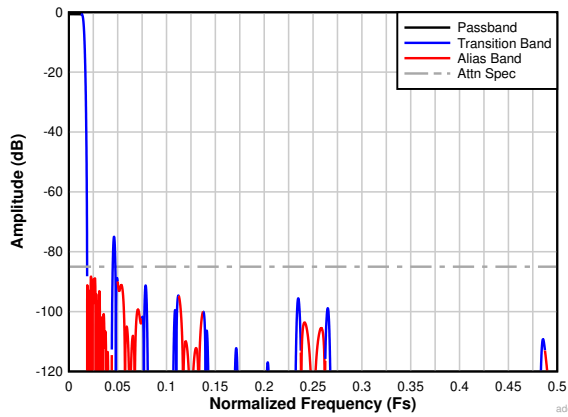

Figure 7-30. Complex Decimation by 32 Filter Response

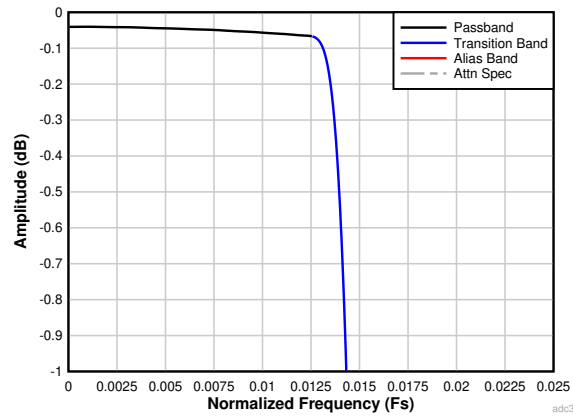

Figure 7-31. Decimation by 32 Passband Ripple Response

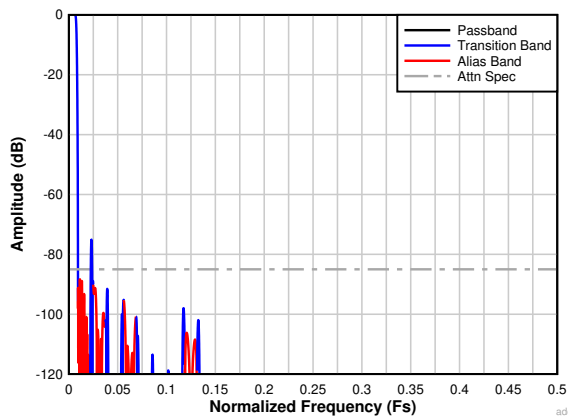

Figure 7-32. Complex Decimation by 64 Filter Response

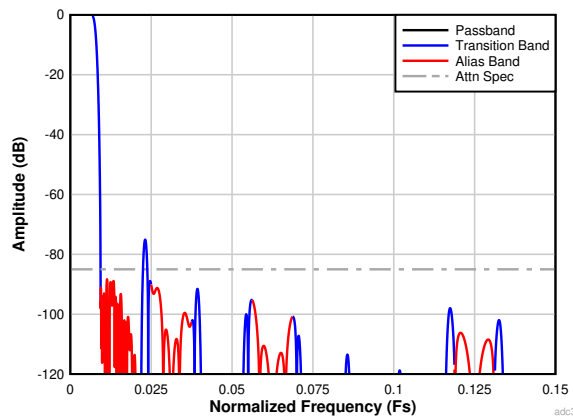

Figure 7-33. Complex Decimation by 64 Filter Response

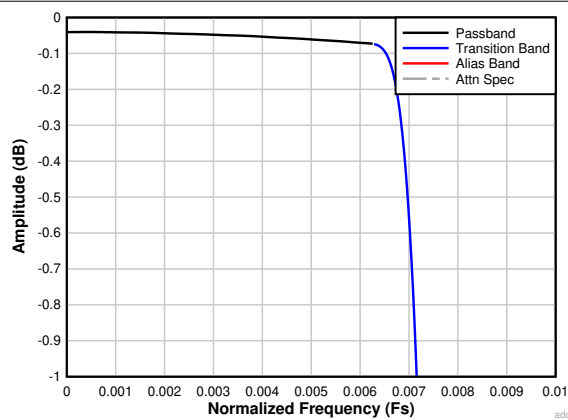

Figure 7-34. Decimation by 64 Passband Ripple Response

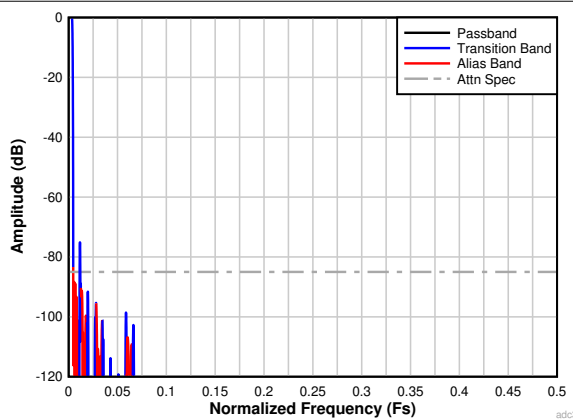

Figure 7-35. Complex Decimation by 128 Filter Response

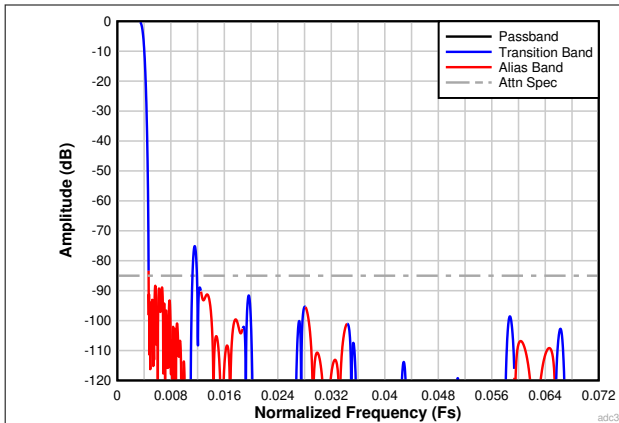

Figure 7-36. Complex Decimation by 128 Filter Response

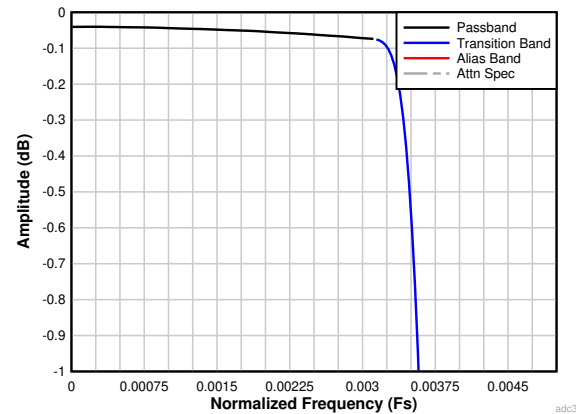

Figure 7-37. Decimation by 128 Passband Ripple Response

7.3.5.2 Decimation Filter Configuration

The decimation filter is configured with these register writes.

Table 7-17. Register Writes to Enable the Internal Decimation Filter

ADDR	DATA	DESCRIPTION
0x05	0x02	Select DIGITAL page
0x2C		Select single/dual/quad band
0x2D		Select decimation
0x05	0x04	Select JESD page
0x22		Select LMFS mode
0x24		Select DDC CLK setting
0x25		Select JESD TX CLK DIV setting
0x9F		Select JESD PLL 1/2 settings
0xA0		Select JESD PLL INPUT1 setting
0xA1		Select JESD PLL INPUT2 settings
0xA2		Select JESD PLL INPUT3 settings

7.3.5.3 20-bit Output Mode

The device includes a 20-bit output resolution mode which can be used for high order decimation (that is, 64x, 128x) in order to avoid SNR degradation due to quantization noise limitation. In this mode the output data is transmitted at 2x the output rate. The 20-bit sample from the DDC gets expanded to 32-bit by adding 12x 0s, and occupies 2 consecutive 16-bit samples. This doubles the number of octets 'F' and the proper LMFS mode and JESD PLL settings have to be selected.

For example, a single band complex decimation would go from LMFS = 2441 (16-bit output mode) to LMFS = 2481 (20-bit output mode) as illustrated in Table 7-18.

Table 7-18. JESD Frame Assembly Comparison between 16-bit and 20-bit Output Mode

LMFS = 2441				LMFS = 2481							
xI ₀ [15:8]	xI ₀ [7:0]	xQ ₀ [15:8]	xQ ₀ [7:0]	xI ₀ [31:24]	xI ₀ [23:16]	xI ₀ [15:8]	xI ₀ [7:0]	xQ ₀ [31:24]	xQ ₀ [23:16]	xQ ₀ [15:8]	xQ ₀ [7:0]
				20-bit sample I				20-bit sample Q			
				0000 0000000				0000 0000000			

The 20-bit output mode is enabled by setting D7 in 0x2C (DIGITAL page) and selecting viable decimation and LMFS mode.

7.3.5.4 Dynamic Switching

The ADC32RF5x supports a dynamic switch mode between two decimation filter configurations without the need to resynchronize the JESD204B interface. This enables support for single, wideband DDC and 4 narrow band DDCs that can be switched in between with minimum impact on latency.

Two different configurations are supported in the dynamic switching mode. Each configuration maintains the # of serdes lanes and serdes output rate during the switch. Table 7-19 shows the specific supported configurations for LMFS and decimation settings for a 2 lane and a 1 lane setup. Since the amount of output data in quad band mode is four times larger compared to single band, the decimation factor in quad band mode needs to be reduced by a factor of four compared to the single band case.

Table 7-19. Dynamic switch configuration modes

	Single Band DDC		Quad Band DDC	
	LMFS	Complex Decimation	LMFS	Complex Decimation
2 lanes	2-4-16-4	/16	2-16-16-1	/64
1 lane	1-4-32-4	/32	1-16-32-1	/128

There is no information in the JESD204B output data stream indicating if the output data is quad band or single band. The JESD204B receiving device controls the switching and thus needs to decode the incoming data for quad band or single band mode. The LMFS value transmitted ILA when the JESD204B link is established is always from the quad band mode in order to avoid ILA errors at the start of the link.

The dynamic switch is configured with these register writes:

Table 7-20. Dynamic switch configuration writes

2 Lanes: 2-4-16-4 to 2-16-16-1		1 Lane: 1-4-32-4 to 1-16-32-1	
Configure ADC 2-16-16-1, Decimation by 64		Configure ADC to 1-16-32-1, Decimation by 128	
0x05, 0x02	Select DIGITAL page	0x05, 0x02	Select DIGITAL page
0x373, 0x04	Configures internal clockings	0x373, 0x05	Configures internal clockings
0x388, 0x12		0x388, 0x16	
0x388, 0x32	Bit D5 enables dynamic switch: 0x32: LMFS = 2-4-16-4, /16 0x12: LMFS = 2-16-16-1, /64	0x388, 0x36	Bit D5 enables dynamic switch: 0x36: LMFS = 1-4-32-4, /32 0x16: LMFS = 1-16-32-1, /128

7.3.5.4.1 2 Lane Mode

JESD transmit (TX) will operate in LMFS = 2-16-16-1 in both the quad and single band modes. The JESD receiver should be configured to and switched between 2-4-16-4 and 2-16-16-1.

Table 7-21. 2 Lane Dynamic Switch Frame Assembly

LMFS	FRAME ASSEMBLY															
2-16-16-1	A1I ₀ [15:8]	A1I ₀ [7:0]	A1Q ₀ [15:8]	A1Q ₀ [7:0]	A2I ₀ [15:8]	A2I ₀ [7:0]	A2Q ₀ [15:8]	A2Q ₀ [7:0]	A3I ₀ [15:8]	A3I ₀ [7:0]	A3Q ₀ [15:8]	A3Q ₀ [7:0]	A4I ₀ [15:8]	A4I ₀ [7:0]	A4Q ₀ [15:8]	A4Q ₀ [7:0]
	B1I ₀ [15:8]	B1I ₀ [7:0]	B1Q ₀ [15:8]	B1Q ₀ [7:0]	B2I ₀ [15:8]	B2I ₀ [7:0]	B2Q ₀ [15:8]	B2Q ₀ [7:0]	B3I ₀ [15:8]	B3I ₀ [7:0]	B3Q ₀ [15:8]	B3Q ₀ [7:0]	B4I ₀ [15:8]	B4I ₀ [7:0]	B4Q ₀ [15:8]	B4Q ₀ [7:0]
2-4-16-4	AI ₀ [15:8]	AI ₀ [7:0]	AI ₁ [15:8]	AI ₁ [7:0]	AI ₂ [15:8]	AI ₂ [7:0]	AI ₃ [15:8]	AI ₃ [7:0]	AQ ₀ [15:8]	AQ ₀ [7:0]	AQ ₁ [15:8]	AQ ₁ [7:0]	AQ ₂ [15:8]	AQ ₂ [7:0]	AQ ₃ [15:8]	AQ ₃ [7:0]
	BI ₀ [15:8]	BI ₀ [7:0]	BI ₁ [15:8]	BI ₁ [7:0]	BI ₂ [15:8]	BI ₂ [7:0]	BI ₃ [15:8]	BI ₃ [7:0]	BQ ₀ [15:8]	BQ ₀ [7:0]	BQ ₁ [15:8]	BQ ₁ [7:0]	BQ ₂ [15:8]	BQ ₂ [7:0]	BQ ₃ [15:8]	BQ ₃ [7:0]

7.3.5.4.2 1 Lane Mode

JESD transmit (TX) will operate in LMFS = 1-16-32-1 in both the quad and single band modes. The JESD receiver should be configured, and switched between 1-4-32-4 and 1-16-32-1.

Table 7-22. 2 Lane Dynamic Switch Frame Assembly

LMFS	FRAME ASSEMBLY																
1-16-32-1	A1I ₀ [15:8]	A1I ₀ [7:0]	A1Q ₀ [15:8]	A1Q ₀ [7:0]	A2I ₀ [15:8]	A2I ₀ [7:0]	A2Q ₀ [15:8]	A2Q ₀ [7:0]	A3I ₀ [15:8]	A3I ₀ [7:0]	A3Q ₀ [15:8]	A3Q ₀ [7:0]	A4I ₀ [15:8]	A4I ₀ [7:0]	A4Q ₀ [15:8]	A4Q ₀ [7:0]	...
	...	B1I ₀ [15:8]	B1I ₀ [7:0]	B1Q ₀ [15:8]	B1Q ₀ [7:0]	B2I ₀ [15:8]	B2I ₀ [7:0]	B2Q ₀ [15:8]	B2Q ₀ [7:0]	B3I ₀ [15:8]	B3I ₀ [7:0]	B3Q ₀ [15:8]	B3Q ₀ [7:0]	B4I ₀ [15:8]	B4I ₀ [7:0]	B4Q ₀ [15:8]	B4Q ₀ [7:0]
1-4-32-4	AI ₀ [15:8]	AI ₀ [7:0]	AI ₁ [15:8]	AI ₁ [7:0]	AI ₂ [15:8]	AI ₂ [7:0]	AI ₃ [15:8]	AI ₃ [7:0]	AQ ₀ [15:8]	AQ ₀ [7:0]	AQ ₁ [15:8]	AQ ₁ [7:0]	AQ ₂ [15:8]	AQ ₂ [7:0]	AQ ₃ [15:8]	AQ ₃ [7:0]	...
	...	BI ₀ [15:8]	BI ₀ [7:0]	BI ₁ [15:8]	BI ₁ [7:0]	BI ₂ [15:8]	BI ₂ [7:0]	BI ₃ [15:8]	BI ₃ [7:0]	BQ ₀ [15:8]	BQ ₀ [7:0]	BQ ₁ [15:8]	BQ ₁ [7:0]	BQ ₂ [15:8]	BQ ₂ [7:0]	BQ ₃ [15:8]	BQ ₃ [7:0]

7.3.5.5 Numerically Controlled Oscillator (NCO)

Each digital down-converter (DDC) uses a 48-bit numerically controlled oscillator (NCO) to fine tune the frequency placement prior to the digital filtering. Different NCO frequencies for each DDC are programmed using SPI register writes and the desired NCO frequency can be selected using SPI or the GPIO pins. When using the GPIO pins for NCO frequency control, frequency hopping can be achieved in less than 1 μ s. The digital NCO is designed to have a SFDR of at least 100 dB. The number of available, programmable NCO frequencies depends on # of DDC bands used as illustrated in Table 7-23.

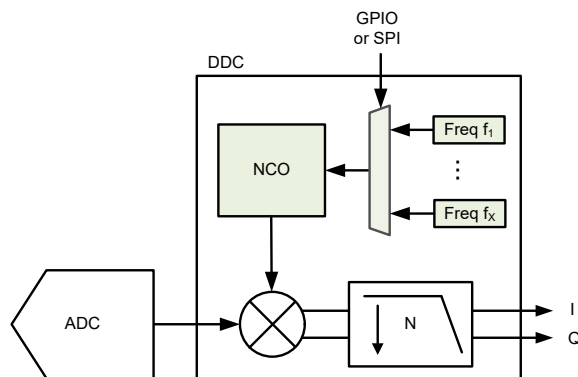

Figure 7-38. NCO Block Diagram

Table 7-23. Available # of Frequencies per NCO Depending on # of DDCs Used

# of DDCs used	# of Frequencies per NCO
1	8
2	4
4	4

There are two NCO operating modes (0x180 in DDC page): phase continuous and infinite phase coherent.

Phase Continuous NCO: During a NCO frequency change, the NCO phase gradually adjusts to the new frequency as shown in Figure 7-39. The dashed line shows the phase of original f_1 frequency.

Infinite Phase Coherent NCO: With a phase coherent NCO, all frequencies are synchronized to a single event using SYSREF. This enables an infinite amount of frequency hops without the need to reset the NCO as phase coherency is maintained between frequency hops. This is illustrated in Figure 7-39 (right). When returning to the original frequency f_1 , the NCO phase appears as if the NCO had never changed frequencies.

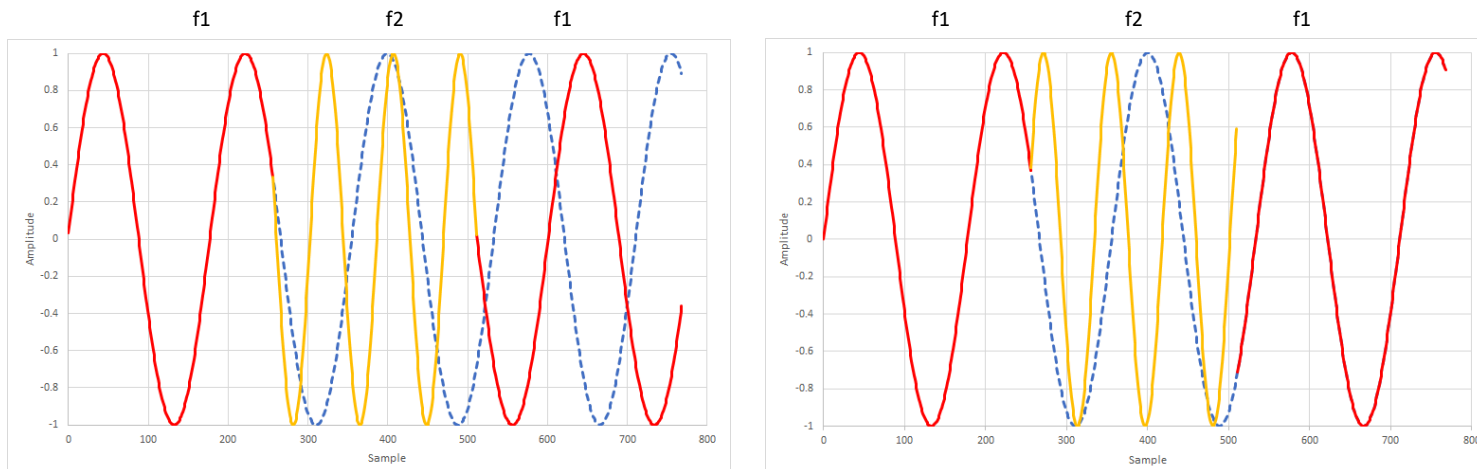

Figure 7-39. Phase Continuous (left) and Infinite Phase Coherent (right) NCO Frequency Switching

The oscillator generates a complex exponential sequence of:

$$e^{j\omega n} \text{ (default) or } e^{-j\omega n} \tag{1}$$

where: frequency (ω) is specified as a signed number by the 48-bit register setting

The complex exponential sequence is multiplied with the real input from the ADC to mix the desired carrier to a frequency equal to $f_{IN} + f_{NCO}$. The NCO frequency can be tuned from $-F_S/2$ to $+F_S/2$ and is processed as a signed, 2s complement number.

The NCO frequency setting is set by the 48-bit register value given and calculated as:

$$\text{NCO frequency (0 to } +F_S/2\text{): } NCO = f_{NCO} \times 2^{48} / F_S \tag{2}$$

$$\text{NCO frequency } (-F_S/2 \text{ to } 0\text{): } NCO = (f_{NCO} + F_S) \times 2^{48} / F_S \tag{3}$$

where:

- NCO = NCO register setting (decimal value)
- f_{NCO} = Desired NCO frequency (MHz)
- F_S = ADC sampling rate (MSPS)

The NCO programming is illustrated with this example:

- ADC sampling rate $F_S = 3000$ MSPS
- Desired NCO frequency = 920 MHz

$$\text{NCO frequency setting} = f_{NCO} \times 2^{48} / F_S = 920 \text{ MHz} \times 2^{48} / 3000 \text{ MSPS} = 86,318,992,857,935 \tag{4}$$

Table 7-24 shows the register writes to set frequency 1 of NCO1 of DDCA to that frequency:

Table 7-24. Example Register Writes to Change NCO Frequency

ADDR	DATA	DESCRIPTION
0x05	0x08	Select DDCA page
0x105	0x4E	Set frequency to 920 MHz (86,318,992,857,935) which is 0x4E81B4E81B4E starting MSB in 0x105.
0x104	0x81	
0x103	0xB4	
0x102	0xE8	
0x101	0x1B	
0x100	0x4E	
0x180	0x01	Enable phase coherent NCO mode
0x181	0x00	Load and update NCO1 with the new frequency. 0x30 updates the NCO values, 0x00 clears the register for the next update.
0x181	0x30	

7.3.5.6 NCO Frequency Programming

There are 4 separate NCOs per channel - one for each band (such as, NCO1 = band 1) and 4 different frequencies can be programmed per NCO as shown in Figure 7-40. The NCO frequencies are located in the DDCA/B pages (0x05 0x08 for channel A and 0x05 0x10 for channel B) in registers 0x100 to 0x17D. Depending on # of bands used, the frequencies for each NCO are selected in registers 0x3B and 0x41 (DIGITAL page) as shown in Table 7-25. If the NCO frequencies are the same for channel A and channel B, they can be written to both DDCA and DDCB pages simultaneously by selecting both pages (0x05 0x18).

Channel A		Channel B	
NCO1 1: 0x100..0x105 2: 0x108..0x10D 3: 0x110..0x115 4: 0x118..0x11D	NCO3 1: 0x140..0x145 2: 0x148..0x14D 3: 0x150..0x155 4: 0x158..0x15D	NCO1 1: 0x100..0x105 2: 0x108..0x10D 3: 0x110..0x115 4: 0x118..0x11D	NCO3 1: 0x140..0x145 2: 0x148..0x14D 3: 0x150..0x155 4: 0x158..0x15D
NCO2 1: 0x120..0x125 2: 0x128..0x12D 3: 0x130..0x135 4: 0x138..0x13D	NCO4 1: 0x160..0x165 2: 0x168..0x16D 3: 0x170..0x175 4: 0x178..0x17D	NCO2 1: 0x120..0x125 2: 0x128..0x12D 3: 0x130..0x135 4: 0x138..0x13D	NCO4 1: 0x160..0x165 2: 0x168..0x16D 3: 0x170..0x175 4: 0x178..0x17D

Figure 7-40. Multi-Band NCO

Single band DDC uses the frequencies of both NCO1 and NCO2 for a combined 8 different frequencies for NCO1 using 3 bit control (NCO2 CHx [1] and NCO1 CHx [1:0]). The NCO2 selection bit (D3) decides if frequencies from NCO1 or NCO2 are being used. In dual and quad band DDC operating mode, there are 4 frequencies per NCO available and selected using 2 register bits (NCOx CHx [1:0]). The NCO frequency selection registers are shown in Table 7-25.

Table 7-25. NCO Frequency Selection SPI Interface Registers

# OF BANDS	ADDR	D7	D6	D5	D4	D3	D2	D1	D0
SINGLE	0x3B	0	0	0	0	NCO2 CHA [1]	0	NCO1 CHA [1:0]	
	0x41	0	0	0	0	NCO2 CHB [1]	0	NCO1 CHB [1:0]	
DUAL	0x3B	0	0	0	0	NCO2 CHA [1:0]		NCO1 CHA [1:0]	
	0x41	0	0	0	0	NCO2 CHB [1:0]		NCO1 CHB [1:0]	
QUAD	0x3B	NCO4 CHA [1:0]		NCO3 CHA [1:0]		NCO2 CHA [1:0]		NCO1 CHA [1:0]	
	0x41	NCO4 CHB [1:0]		NCO3 CHB [1:0]		NCO2 CHB [1:0]		NCO1 CHB [1:0]	

To select a different frequency for the NCO, two registers (0x3B and 0x41) in the DIGITAL page have to be updated. Assuming a SPI clock frequency of 10 MHz (100 ns period), programming two registers (2x (16 bit address and 8 bit data) = 48 bit) means that the NCO frequency would be updated in ~ 5 us.

When updating the currently being used NCO frequency to a new frequency, the following command has to be written in order to load the new frequency into the NCO - 0x181 0x00/0x30 in each of the DDCA/B pages.

Table 7-26. Example Register Writes

ADDR	DATA	DESCRIPTION
0x05	0x02	Select DIGITAL page
0x3B	0x01	Select frequency 2 for NCO1 of channel A.
0x235	0xFF	Select NCO using SPI
0x05	0x08	Select DDCA page
0x10D...0x108	0x..	Write new frequency in frequency 2 of NCO1 of channel A

Table 7-26. Example Register Writes (continued)

ADDR	DATA	DESCRIPTION
0x181	0x00	Update NCO with current frequencies from the register map.
0x181	0x30	

The NCO phase accumulators can be reset using the external SYSREF signal. A SYSREF mask can be setup such the SYSREF signal only goes to the NCO and the remaining device remains unaffected. The following register writes configure the SYSREF mask to only affect the NCO. After completion, the SYSREF mask should be set back to default.

Table 7-27. Example Register Writes to configure the SYSREF MASK

ADDR	DATA	DESCRIPTION
0x05	0x02	Select DIGITAL page
0x357	0xA2	SYSREF mask settings (0x00 is mask default)
0x358	0x02	SYSREF mask settings (0x00 is mask default)

7.3.5.7 Fast Frequency Hopping

The ADC32RF5x supports several different options to update the NCO frequencies. Fast frequency hopping can be achieved in one of the following ways:

- Using the GPIO1/2 pins to select the NCO frequency
- Using the GPIO1/2, SPISEL and SCLK/SDIO pins to select the NCO frequency
- Using the GPIO1/2 pins to program the NCO frequency selection (Fast SPI)

NCO CONTROL	SCLK	SDIO	SPISEL	GPIO1	GPIO2	NCO SEL MODE
Regular SPI (default)	SPI Interface		0	used for other purpose		00
GPIO1/2	SPI Interface		0	used for NCO control		00
GPIO1/2, SPISEL, SCLK/SDIO	NCO CONTROL		1	used for NCO control		00
FAST SPI	SPI Interface		1	SDIO	SCLK	10

The internal NCO is switched quickly; however, the switching time depends primarily on the time it takes to flush out the decimation filter as shown in [Table 7-28](#).

Table 7-28. NCO Switching Time ($F_S = 2.6$ GSPS) vs Decimation Setting

Decimation Setting	NCO Switching Time
/4	~ 250 ns
/8	~ 350 ns
/16	~ 600 ns
/32	~ 1 us
/64	~ 2 us
/128	~ 4 us

7.3.5.7.1 Fast frequency hopping Using the GPIO1/2 pins

The NCO frequency is selected as shown in [Table 7-29](#). This mode is enabled with the following register write:

1. Set 0x234 to 0x03 (NCO SEL MODE = 0, GPIO MODE = 3)

Table 7-29. NCO Frequency Selection Using GPIO1/2 Pins

# OF BANDS	GPIO2	GPIO1	GPIO2	GPIO1	GPIO2	GPIO1	GPIO2	GPIO1
SINGLE	0	0	0	0	0	0	NCO1 CHA [1:0]	
	0	0	0	0	0	0	NCO1 CHB [1:0]	
DUAL	0	0	0	0	NCO2 CHA [1:0]		NCO1 CHA [1:0]	
	0	0	0	0	NCO2 CHB [1:0]		NCO1 CHB [1:0]	
QUAD	NCO4 CHA [1:0]		NCO3 CHA [1:0]		NCO2 CHA [1:0]		NCO1 CHA [1:0]	
	NCO4 CHB [1:0]		NCO3 CHB [1:0]		NCO2 CHB [1:0]		NCO1 CHB [1:0]	

7.3.5.7.2 Fast frequency hopping using GPIO1/2, SEN and SDIO pins

This mode is enabled by setting the SPISEL to logic high and using the following register write:

1. Set 0x234 to 0x63 (NCO SEL MODE = 3, GPIO MODE = 3)

Table 7-30. NCO Frequency Selection SPI Interface Registers

# OF BANDS	SDIO	SEN	GPIO2	GPIO1	SDIO	SEN	GPIO2	GPIO1
SINGLE	0	0	0	0	NCO2 CHA [1]	0	NCO1 CHA [1:0]	
	0	0	0	0	NCO2 CHB [1]	0	NCO1 CHB [1:0]	
DUAL	0	0	0	0	NCO2 CHA [1:0]		NCO1 CHA [1:0]	
	0	0	0	0	NCO2 CHB [1:0]		NCO1 CHB [1:0]	
QUAD	NCO4 CHA [1:0]		NCO3 CHA [1:0]		NCO2 CHA [1:0]		NCO1 CHA [1:0]	
	NCO4 CHB [1:0]		NCO3 CHB [1:0]		NCO2 CHB [1:0]		NCO1 CHB [1:0]	

7.3.5.7.3 Fast Frequency Hopping Using the Fast SPI

In this mode, the GPIO1/2 pins are used as a "fast SPI" input which only updates the NCO selection registers. No register address information needs to be sent. GPIO1 pin is SDIO and GPIO2 pin is SCLK.

This mode is enabled by setting the SPISEL to logic high and using the following register write:

1. Set 0x234 to 0x43 (NCO SEL MODE = 2, GPIO MODE = 3)

The NCO frequencies are selected as shown in [Table 7-31](#).

Table 7-31. NCO Frequency Programming Using FAST SPI

# OF BANDS	D15	D14	D13	D12	D11	D10	D9	D8	D7	D6	D5	D4	D3	D2	D1	D0
SINGLE	0	0	0	0	NCO1 CHB [2]	0	NCO1 CHB [1:0]		0	0	0	0	NCO1 CHA [2]	0	NCO1 CHA [1:0]	
DUAL	0	0	0	0	NCO2 CHB [1:0]		NCO1 CHB [1:0]		0	0	0	0	NCO2 CHA [1:0]		NCO1 CHA [1:0]	
QUAD	NCO4 CHB [1:0]		NCO3 CHB [1:0]		NCO2 CHB [1:0]		NCO1 CHB [1:0]		NCO4 CHA [1:0]		NCO3 CHA [1:0]		NCO2 CHA [1:0]		NCO1 CHA [1:0]	

7.3.6 JESD204B Interface

The ADC32RF5x uses the JESD204B high-speed serial interface to transfer data from the ADC to the receiving logic device. ADC32RF5x serialized lanes are capable of operating up to 13 Gbps, slightly above the JESD204B max lane rate. A maximum of 8 lanes can be used to allow lower lane rates for interfacing with speed limited logic devices. Figure 7-41 shows a simplified block diagram of the JESD204B interface.

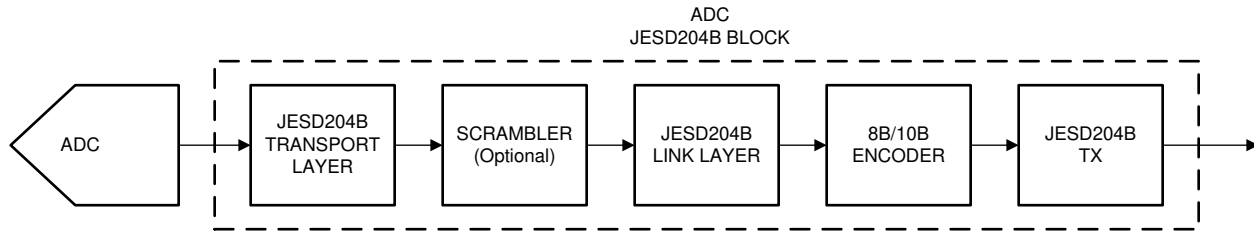

Figure 7-41. JESD204B Block Diagram

7.3.6.1 JESD204B Initial Lane Alignment (ILA)

The receiving device starts the initial lane alignment process by deasserting the $\overline{\text{SYNC}}$ signal. When a logic low state is detected on the $\overline{\text{SYNC}}$ input, the ADC starts transmitting comma characters (K28.5) in order to establish the code group synchronization, as shown in Figure 7-42. When synchronization is completed, the receiving device reasserts the $\overline{\text{SYNC}}$ signal and the ADC starts the initial lane alignment sequence with the next local multi-frame clock (LMFC) boundary. The ADC transmits four multi-frames, each containing K frame (K is SPI programmable). Each of the multi-frames contains the frame start and frame end symbols. The second multi-frame also contains the JESD204B link configuration data.

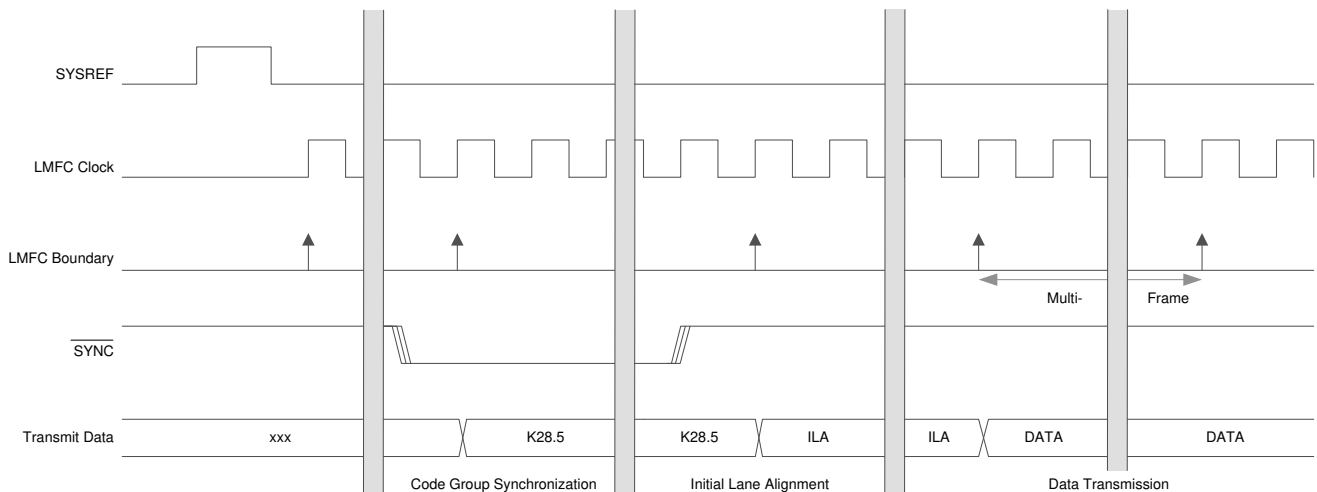

Figure 7-42. JESD204B Internal Timing Diagram

7.3.6.1.1 $\overline{\text{SYNC}}$ Signal

The $\overline{\text{SYNC}}$ signal can be issued using one of two different methods:

- One of the GPIO1/2 pins can be configured via SPI to become the $\overline{\text{SYNC}}$ input pin (address 0x234 in the digital page)
- The synchronization command can be issued via SPI register write (address 0x21 in the JESD page)

When using the GPIO1/2 pins for the $\overline{\text{SYNC}}$ signal input, the device also supports the option to invert the signal polarity (address 0x236 in the digital page).

7.3.6.2 JESD204B Frame Assembly

The JESD204B standard defines the following parameters:

- L: number of lanes per link
- M: number of converters per device
- F: number of octets per frame clock period
- S: number of samples per frame

7.3.6.3 JESD204B Frame Assembly in Bypass Mode

Table 7-32 lists the available JESD204B formats and corresponding valid sampling rate ranges for the ADC32RF5x. The sampling rates are limited by the minimum and maximum SERDES line rate as well as ADC sampling clock frequencies. The JESD204B frame assembly for the different lanes is shown in Table 7-33.

When internal digital averaging is used, the output resolution is automatically adjusted from 14-bit to 16-bit to avoid quantization noise limitation.

Table 7-32. JESD Mode Options: Bypass Mode

DECIMATION SETTING D (complex)	OUTPUT RESOLUTION (Bits)	L	M	F	S	MIN F _S (Gsp/s)	MAX F _S (Gsp/s)	RATIO [f _{SERDES} /F _S]
Bypass	12 ⁽¹⁾	8	2	8	20	0.5	3.0	4
	14/16 ⁽²⁾	8	2	2	4	0.5	2.6	5
		4	2	2	2	0.5	1.3	10

(1) In full rate output, two LSBs are truncated to a 12-bit output.

(2) When using digital averaging the output resolution changes to 16-bit.

Table 7-33. JESD Sample Frame Assembly: Bypass Mode

OUTPUT LANE	LMFS = 82820								LMFS = 8224		LMFS = 4222	
DOUT0	A ₀ [11:4]	A ₀ [3:0], A ₁ [11:8]	A ₁ [7:0]	A ₂ [11:4]	A ₂ [3:0], A ₃ [11:8]	A ₃ [7:0]	A ₄ [11:4]	A ₄ [3:0], 0000	A ₀ [13:6]	A ₀ [5:0], 00	A ₀ [13:6]	A ₀ [5:0], 00
DOUT1	A ₅ [11:4]	A ₅ [3:0], A ₆ [11:8]	A ₆ [7:0]	A ₇ [11:4]	A ₇ [3:0], A ₈ [11:8]	A ₈ [7:0]	A ₉ [11:4]	A ₉ [3:0], 0000	A ₁ [13:6]	A ₁ [5:0], 00	A ₁ [13:6]	A ₁ [5:0], 00
DOUT2	A ₁₀ [11:4]	A ₁₀ [3:0], A ₁₁ [11:8]	A ₁₁ [7:0]	A ₁₂ [11:4]	A ₁₂ [3:0], A ₁₃ [11:8]	A ₁₃ [7:0]	A ₁₄ [11:4]	A ₁₄ [3:0], 0000	A ₂ [13:6]	A ₂ [5:0], 00	B ₀ [13:6]	B ₀ [5:0], 00
DOUT3	A ₁₅ [11:4]	A ₁₅ [3:0], A ₁₆ [11:8]	A ₁₆ [7:0]	A ₁₇ [11:4]	A ₁₇ [3:0], A ₁₈ [11:8]	A ₁₈ [7:0]	A ₁₉ [11:4]	A ₁₉ [3:0], 0000	A ₃ [13:6]	A ₃ [5:0], 00	B ₁ [13:6]	B ₁ [5:0], 00
DOUT4	B ₀ [11:4]	B ₀ [3:0], B ₁ [11:8]	B ₁ [7:0]	B ₂ [11:4]	B ₂ [3:0], B ₃ [11:8]	B ₃ [7:0]	B ₄ [11:4]	B ₄ [3:0], 0000	B ₀ [13:6]	B ₀ [5:0], 00		
DOUT5	B ₅ [11:4]	B ₅ [3:0], B ₆ [11:8]	B ₆ [7:0]	B ₇ [11:4]	B ₇ [3:0], B ₈ [11:8]	B ₈ [7:0]	B ₉ [11:4]	B ₉ [3:0], 0000	B ₁ [13:6]	B ₁ [5:0], 00		
DOUT6	B ₁₀ [11:4]	B ₁₀ [3:0], B ₁₁ [11:8]	B ₁₁ [7:0]	B ₁₂ [11:4]	B ₁₂ [3:0], B ₁₃ [11:8]	B ₁₃ [7:0]	B ₁₄ [11:4]	B ₁₄ [3:0], 0000	B ₂ [13:6]	B ₂ [5:0], 00		
DOUT7	B ₁₅ [11:4]	B ₁₅ [3:0], B ₁₆ [11:8]	B ₁₆ [7:0]	B ₁₇ [11:4]	B ₁₇ [3:0], B ₁₈ [11:8]	B ₁₈ [7:0]	B ₁₉ [11:4]	B ₁₉ [3:0], 0000	B ₃ [13:6]	B ₃ [5:0], 00		

7.3.6.4 JESD204B Frame Assembly with Complex Decimation - Single Band

Table 7-34 lists the available JESD204B interface formats and corresponding valid sampling rate ranges for the ADC32RF5x with complex decimation (single band). The sampling rates are limited by the minimum and maximum SERDES line rate as well as ADC sampling clock frequencies. The JESD204B frame assembly for the different lanes is shown in Table 7-33.

Table 7-34. JESD Mode Options: Complex Decimation - Single Band

DECIMATION SETTING D (complex)	L	M	F	S	MIN F _S (Gbps)	MAX F _S (Gbps)	RATIO [f _{SERDES} /(F _S /D)]
/4	8	4	2	2	0.5	3.0	10
/8					0.8		
/32					1.6		
/4	4	4	2	1	0.5	2.6	20
/8						3.0	
/16							
/32							
/64	2	4	4	1	0.5	3.0	40
/8							
/16							
/32							
/64	1	4	8	1	0.5	1.3	80
/128						3.0	
/8							
/16							
/32							
/64	0.8						
/128							

Table 7-35. JESD Sample Frame Assembly: Complex Decimation - Single Band

OUTPUT LANE	LMFS = 8422		LMFS = 4421		LMFS = 2441				LMFS = 1481							
	AI ₀ [15:8]	AI ₀ [7:0]	AI ₀ [15:8]	AI ₀ [7:0]	AI ₀ [15:8]	AI ₀ [7:0]	AQ ₀ [15:8]	AQ ₀ [7:0]	AI ₀ [15:8]	AI ₀ [7:0]	AQ ₀ [15:8]	AQ ₀ [7:0]	BI ₀ [15:8]	BI ₀ [7:0]	BQ ₀ [15:8]	BQ ₀ [7:0]
DOUT0	AI ₀ [15:8]	AI ₀ [7:0]	AI ₀ [15:8]	AI ₀ [7:0]	AI ₀ [15:8]	AI ₀ [7:0]	AQ ₀ [15:8]	AQ ₀ [7:0]	AI ₀ [15:8]	AI ₀ [7:0]	AQ ₀ [15:8]	AQ ₀ [7:0]	BI ₀ [15:8]	BI ₀ [7:0]	BQ ₀ [15:8]	BQ ₀ [7:0]
DOUT1	AI ₁ [15:8]	AI ₁ [7:0]	AQ ₀ [15:8]	AQ ₀ [7:0]	BI ₀ [15:8]	BI ₀ [7:0]	BQ ₀ [15:8]	BQ ₀ [7:0]								
DOUT2	AQ ₀ [15:8]	AQ ₀ [7:0]	BI ₀ [15:8]	BI ₀ [7:0]												
DOUT3	AQ ₁ [15:8]	AQ ₁ [7:0]	BQ ₀ [15:8]	BQ ₀ [7:0]												
DOUT4	BI ₀ [15:8]	BI ₀ [7:0]														
DOUT5	BI ₁ [15:8]	BI ₁ [7:0]														
DOUT6	BQ ₀ [15:8]	BQ ₀ [7:0]														
DOUT7	BQ ₁ [15:8]	BQ ₁ [7:0]														

7.3.6.5 JESD204B Frame Assembly with Complex Decimation - Dual Band

Table 7-36 lists the available JESD204B interface formats and corresponding valid sampling rate ranges for the ADC32RF5x with complex decimation (dual band). The sampling rates are limited by the minimum and maximum SERDES line rate as well as ADC sampling clock frequencies. The JESD204B frame assembly for the different lanes are shown in Table 7-37 and Table 7-38.

Table 7-36. JESD Mode Options: Complex Decimation - Dual Band

DECIMATION SETTING D (complex)	L	M	F	S	MIN F_S (Gbps)	MAX F_S (Gbps)	RATIO [$f_{SERDES}/(F_S/D)$]
/8	8	8	2	1	0.5	3.0	20
/16					0.8		
/32					1.6		
/64	4	8	4	1	0.5	2.6	40
/128						3.0	
/16							
/32							
/64	2	8	8	1	0.5	1.3	80
/128						2.6	
/16						3.0	
/32							
/64							
/128	1	8	16	1	0.5	1.3	160
/16						2.6	
/32							
/64							
/128						3.0	

Table 7-37. JESD Sample Frame Assembly: Complex Decimation - Dual Band

OUTPUT LANE	LMFS = 8821		LMFS = 4841				LMFS = 2881							
	A1I ₀ [15:8]	A1I ₀ [7:0]	A1I ₀ [15:8]	A1I ₀ [7:0]	A1Q ₀ [15:8]	A1Q ₀ [7:0]	A1I ₀ [15:8]	A1I ₀ [7:0]	A1Q ₀ [15:8]	A1Q ₀ [7:0]	A2I ₀ [15:8]	A2I ₀ [7:0]	A2Q ₀ [15:8]	A2Q ₀ [7:0]
DOUT0	A1I ₀ [15:8]	A1I ₀ [7:0]	A1I ₀ [15:8]	A1I ₀ [7:0]	A1Q ₀ [15:8]	A1Q ₀ [7:0]	A1I ₀ [15:8]	A1I ₀ [7:0]	A1Q ₀ [15:8]	A1Q ₀ [7:0]	A2I ₀ [15:8]	A2I ₀ [7:0]	A2Q ₀ [15:8]	A2Q ₀ [7:0]
DOUT1	A1Q ₀ [15:8]	A1Q ₀ [7:0]	A2I ₀ [15:8]	A2I ₀ [7:0]	A2Q ₀ [15:8]	A2Q ₀ [7:0]	B1I ₀ [15:8]	B1I ₀ [7:0]	B1Q ₀ [15:8]	B1Q ₀ [7:0]	B2I ₀ [15:8]	B2I ₀ [7:0]	B2Q ₀ [15:8]	B2Q ₀ [7:0]
DOUT2	A2I ₀ [15:8]	A2I ₀ [7:0]	B1I ₀ [15:8]	B1I ₀ [7:0]	B1Q ₀ [15:8]	B1Q ₀ [7:0]								
DOUT3	A2Q ₀ [15:8]	A2Q ₀ [7:0]	B2I ₀ [15:8]	B2I ₀ [7:0]	B2Q ₀ [15:8]	B2Q ₀ [7:0]								
DOUT4	B1I ₀ [15:8]	B1I ₀ [7:0]												
DOUT5	B1Q ₀ [15:8]	B1Q ₀ [7:0]												
DOUT6	B2I ₀ [15:8]	B2I ₀ [7:0]												
DOUT7	B2Q ₀ [15:8]	B2Q ₀ [7:0]												

Table 7-38. JESD Sample Frame Assembly: Complex Decimation - Dual Band

OUTPUT LANE	LMFS = 1-8-16-1															
	A1I ₀ [15:8]	A1I ₀ [7:0]	A1Q ₀ [15:8]	A1Q ₀ [7:0]	A2I ₀ [15:8]	A2I ₀ [7:0]	A2Q ₀ [15:8]	A2Q ₀ [7:0]	B1I ₀ [15:8]	B1I ₀ [7:0]	B1Q ₀ [15:8]	B1Q ₀ [7:0]	B2I ₀ [15:8]	B2I ₀ [7:0]	B2Q ₀ [15:8]	B2Q ₀ [7:0]
DOUT 0																
DOUT 1																
DOUT 2																
DOUT 3																
DOUT 4																
DOUT 5																
DOUT 6																
DOUT 7																

7.3.6.6 JESD204B Frame Assembly with Complex Decimation - Quad Band

Table 7-39 lists the available JESD204B interface formats and corresponding valid sampling rate ranges for the ADC32RF5x with complex decimation (quad band). The sampling rates are limited by the minimum and maximum SERDES line rate as well as ADC sampling clock frequencies. The JESD204B frame assembly for the different lanes are shown in Table 7-40, Table 7-41 and Table 7-42.

Table 7-39. JESD Mode Options: Complex Decimation - Quad Band

DECIMATION SETTING D (complex)	L	M	F	S	MIN F _S (Gbps)	MAX F _S (Gbps)	RATIO [f _{SERDES} /(F _S /D)]
/16	8	16	4	1	0.5	3.0	40
/32					0.8		
/128					1.6		
/16	4	16	8	1	0.5	2.6	80
/32					3.0		
/128						0.8	
/16	2	16	16	1	0.5	1.3	160
/32						2.6	
/128						3.0	
/16	1	16	32	1	0.5	0.65	320
/32						1.3	
/128						3.0	

Table 7-40. JESD Sample Frame Assembly: Complex Decimation - Quad Band

OUTPUT LANE	LMFS = 8-16-4-1				LMFS = 4-16-8-1							
	DOUT0	A1 ₀ [15:8]	A1 ₀ [7:0]	A1Q ₀ [15:8]	A1Q ₀ [7:0]	A1 ₀ [15:8]	A1 ₀ [7:0]	A1Q ₀ [15:8]	A1Q ₀ [7:0]	A2 ₀ [15:8]	A2 ₀ [7:0]	A2Q ₀ [15:8]
DOUT1	A2 ₀ [15:8]	A2 ₀ [7:0]	A2Q ₀ [15:8]	A2Q ₀ [7:0]	A3 ₀ [15:8]	A3 ₀ [7:0]	A3Q ₀ [15:8]	A3Q ₀ [7:0]	A4 ₀ [15:8]	A4 ₀ [7:0]	A4Q ₀ [15:8]	A4Q ₀ [7:0]
DOUT2	A3 ₀ [15:8]	A3 ₀ [7:0]	A3Q ₀ [15:8]	A3Q ₀ [7:0]	B1 ₀ [15:8]	B1 ₀ [7:0]	B1Q ₀ [15:8]	B1Q ₀ [7:0]	B2 ₀ [15:8]	B2 ₀ [7:0]	B2Q ₀ [15:8]	B2Q ₀ [7:0]
DOUT3	A4 ₀ [15:8]	A4 ₀ [7:0]	A4Q ₀ [15:8]	A4Q ₀ [7:0]	B3 ₀ [15:8]	B3 ₀ [7:0]	B3Q ₀ [15:8]	B3Q ₀ [7:0]	B4 ₀ [15:8]	B4 ₀ [7:0]	B4Q ₀ [15:8]	B4Q ₀ [7:0]
DOUT4	B1 ₀ [15:8]	B1 ₀ [7:0]	B1Q ₀ [15:8]	B1Q ₀ [7:0]								
DOUT5	B2 ₀ [15:8]	B2 ₀ [7:0]	B2Q ₀ [15:8]	B2Q ₀ [7:0]								
DOUT6	B3 ₀ [15:8]	B3 ₀ [7:0]	B3Q ₀ [15:8]	B3Q ₀ [7:0]								
DOUT7	B4 ₀ [15:8]	B4 ₀ [7:0]	B4Q ₀ [15:8]	B4Q ₀ [7:0]								

Table 7-41. JESD Sample Frame Assembly: Complex Decimation - Quad Band

OUTPUT LANE	LMFS = 2-16-16-1															
	DOUT 0	A1I ₀ [15:8]	A1I ₀ [7:0]	A1Q ₀ [15:8]	A1Q ₀ [7:0]	A2I ₀ [15:8]	A2I ₀ [7:0]	A2Q ₀ [15:8]	A2Q ₀ [7:0]	A3I ₀ [15:8]	A3I ₀ [7:0]	A3Q ₀ [15:8]	A3Q ₀ [7:0]	A4I ₀ [15:8]	A4I ₀ [7:0]	A4Q ₀ [15:8]
DOUT 1	B1I ₀ [15:8]	B1I ₀ [7:0]	B1Q ₀ [15:8]	B1Q ₀ [7:0]	B2I ₀ [15:8]	B2I ₀ [7:0]	B2Q ₀ [15:8]	B2Q ₀ [7:0]	B3I ₀ [15:8]	B3I ₀ [7:0]	B3Q ₀ [15:8]	B3Q ₀ [7:0]	B4I ₀ [15:8]	B4I ₀ [7:0]	B4Q ₀ [15:8]	B4Q ₀ [7:0]
DOUT 2																
DOUT 3																
DOUT 4																
DOUT 5																
DOUT 6																
DOUT 7																

Table 7-42. JESD Sample Frame Assembly: Complex Decimation - Quad Band

OUTPUT LANE	LMFS = 1-16-32-1																
	DOUT 0	A1I ₀ [15:8]	A1I ₀ [7:0]	A1Q ₀ [15:8]	A1Q ₀ [7:0]	A2I ₀ [15:8]	A2I ₀ [7:0]	A2Q ₀ [15:8]	A2Q ₀ [7:0]	A3I ₀ [15:8]	A3I ₀ [7:0]	A3Q ₀ [15:8]	A3Q ₀ [7:0]	A4I ₀ [15:8]	A4I ₀ [7:0]	A4Q ₀ [15:8]	A4Q ₀ [7:0]
...		B1I ₀ [15:8]	B1I ₀ [7:0]	B1Q ₀ [15:8]	B1Q ₀ [7:0]	B2I ₀ [15:8]	B2I ₀ [7:0]	B2Q ₀ [15:8]	B2Q ₀ [7:0]	B3I ₀ [15:8]	B3I ₀ [7:0]	B3Q ₀ [15:8]	B3Q ₀ [7:0]	B4I ₀ [15:8]	B4I ₀ [7:0]	B4Q ₀ [15:8]	B4Q ₀ [7:0]
DOUT 1																	
DOUT 2																	
DOUT 3																	
DOUT 4																	
DOUT 5																	
DOUT 6																	
DOUT 7																	

7.3.7 SERDES Output MUX

The SERDES output block contains one digital mux per SERDES output lane with a 3-bit register. This allows routing any of the 8 digital streams to any output serdes transmitter as shown in the example in Figure 7-43. The MUX can be used to reorder lanes as well as duplicate lane outputs (for example in LMFS = 1-4-8-1 mode the same output stream could be duplicated on all 8 lanes).

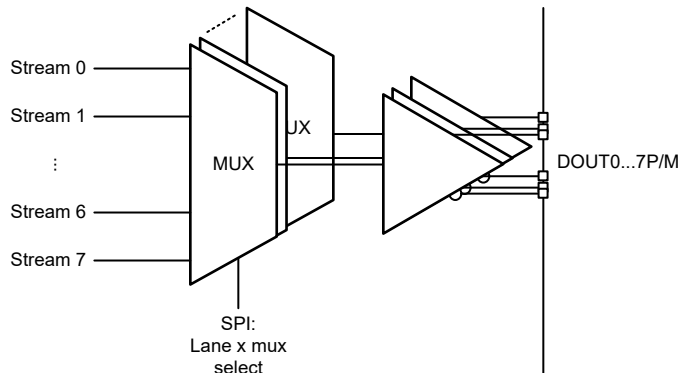

Figure 7-43. SERDES output mux for DOUT0

By default after power, the active SERDES lanes start on lane DOUT0 as shown for the complex decimation dual band example in Table 7-43. After power up, the output is transmitted on lanes DOUT0..3. Using the digital output muxes, the output data for channel B is shifted from lanes DOUT2,3 to DOUT4,5. All SERDES transmitters are powered up and enabled by default. After configuring the output mux unused lanes can be powered down to save power consumption.

Table 7-43. JESD Sample Frame Assembly: Complex Decimation - Dual Band with LMFS = 4841

OUTPUT LANE	Default				Using MUX			
DOUT0	A1I ₀ [15:8]	A1I ₀ [7:0]	A1Q ₀ [15:8]	A1Q ₀ [7:0]	A1I ₀ [15:8]	A1I ₀ [7:0]	A1Q ₀ [15:8]	A1Q ₀ [7:0]
DOUT1	A2I ₀ [15:8]	A2I ₀ [7:0]	A2Q ₀ [15:8]	A2Q ₀ [7:0]	A2I ₀ [15:8]	A2I ₀ [7:0]	A2Q ₀ [15:8]	A2Q ₀ [7:0]
DOUT2	B1I ₀ [15:8]	B1I ₀ [7:0]	B1Q ₀ [15:8]	B1Q ₀ [7:0]				
DOUT3	B2I ₀ [15:8]	B2I ₀ [7:0]	B2Q ₀ [15:8]	B2Q ₀ [7:0]				
DOUT4					B1I ₀ [15:8]	B1I ₀ [7:0]	B1Q ₀ [15:8]	B1Q ₀ [7:0]
DOUT5					B2I ₀ [15:8]	B2I ₀ [7:0]	B2Q ₀ [15:8]	B2Q ₀ [7:0]
DOUT6								
DOUT7								

Table 7-44 shows the register writes to shift the output lanes from default as illustrated in Table 7-43.

Table 7-44. Example register writes to shift the output serdes lanes using the SERDES Output MUX

ADDR	DATA	DESCRIPTION
0x05	0x04	Select JESD page
0x81	0x54	Select internal JESD streams 4 and 5 to lanes DOUT2 and DOUT3
0x82	0x32	Select internal JESD streams 2 and 3 to lanes DOUT4 and DOUT5

7.3.8 Test Pattern

The ADC32RF5x provides two different options to output test patterns instead of the actual output data of the ADC in order to simplify the serial interface and system debug of the JESD204B digital interface link. The output data path is shown in \.

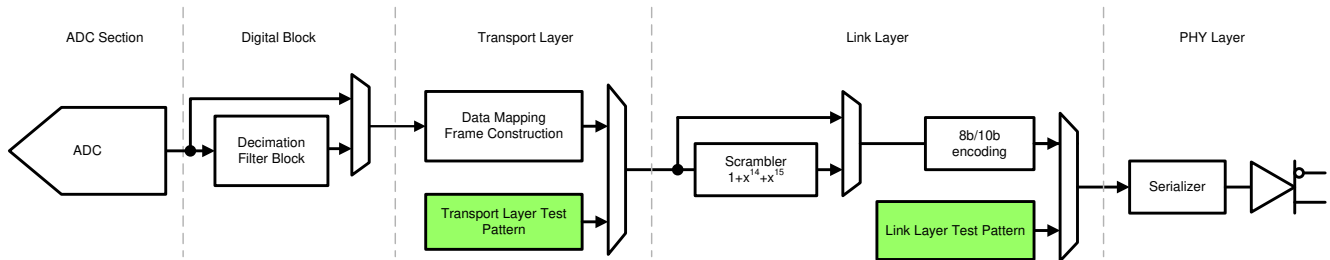

Figure 7-44. Test Pattern Options

The available test patterns in each block are described in Table 7-45. Both test pattern blocks replace output data from the digital block, and not from the ADC; therefore, it is available in decimation or decimation bypass mode. The test patterns are synchronized with the SYSREF signal.

Table 7-45. Test Pattern Overview

TEST PATTERN LOCATION	TYPE	8b/10b encoded	REGISTER PAGE	REGISTER
TRANSPORT LAYER	CUSTOM PATTERN	Yes	JESD 0x05 0x04	0x2E, D0
	TOGGLE 1010 PATTERN	Yes		0x2E, D1
	RAMP PATTERN	Yes		0x2E, D2
LINK LAYER	JESD204B TEST PATTERNS	Depends		0x2D, D2-D0
	PRBS PATTERN ($2^7..2^{31}$)	No		0x2F, D6-D4

The RAMP pattern provides two different output options. Internally each ADC data bus consists of parallel data streams (1 stream per serdes lane). The RAMP pattern is generated for each stream and a different starting value can be set for each stream. By default, the starting values are 0. For example, a LMFS mode using 4 lanes/ADC would show a *slow* ramp which increments once every 4 clock cycles with starting values set to 0 and ramp increment = 1. Also, a RAMP pattern which increments every clock cycle can be set using different starting values (such as 0, 1, 2, 3) for the 4 streams/lanes and setting the RAMP increment to 4. The follow table shows how to enable the RAMP test pattern.

Table 7-46. RAMP Test Pattern

ADDR	DATA	DESCRIPTION
0x05	0x04	Select JESD page
0x32	0x01	Set lane DOUT1 starting value = 1
0x34	0x02	Set lane DOUT2 starting value = 2
0x36	0x03	Set lane DOUT3 starting value = 3
0x42	0x01	Set lane DOUT5 starting value = 1
0x44	0x02	Set lane DOUT6 starting value = 2
0x46	0x03	Set lane DOUT7 starting value = 3
0x2E	0x34	Enable RAMP pattern, RAMP increment = 4

7.3.8.1 Transport Layer

The transport layer maps the ADC output data into 8-bit octets and constructs the JESD204B frames using the LMFS parameters. Tail bits or 0's are added when needed. Alternatively, test patterns can be substituted instead of the ADC data with the JESD frame, as shown in Table 7-45.

7.3.8.2 Link Layer

The link layer contains the scrambler and the 8b/10b encoding of any data passed on from the transport layer. Additionally, the link layer controls the initial lane alignment sequence that can be manually restarted. The link layer test patterns are intended for testing the quality of the link (jitter testing and so forth). The test patterns do not pass through the 8b/10b encoder and contain the options listed in [Table 7-45](#).

7.3.8.3 Internal Capture Memory Buffer

The ADC includes a small internal capture memory buffer which can store up to 64 samples. Once a strobe is given to the memory using SPI register write, the memory will store the next continuous 64 samples of one ADC channel (selected via SPI register write) and stop. The samples are captured from the ADC cores (prior to averaging or decimation). These samples can be read back using the SPI interface without involving the JESD204B interface at all.

This mode allows debug of the analog front end during the initial bring-up phase even if the JESD204B interface is not operational yet.

Table 7-47. Register writes to enable the internal sample capture buffer

ADDR	DATA	DESCRIPTION
0x05	0x02	Select DIGITAL page
0x34		Select ADC channel (D5/D4) and give strobe (D6). The 64 samples are stored in 0x800 to 0x87F in the digital page

7.4 Device Functional Modes

The device offers two different operating modes: bypass mode (1x AVG) and digital averaging (2x/4x AVG). Both operating modes use the same digital back end and JESD204B output configurations.

7.4.1 Digital Averaging

The ADC32RF5x provides a total of eight internal single core 3.0 Gsps ADCs. Normal bypass mode uses only two ADC cores (one ADC per channel). However, the additional six ADCs can be used to trade off further noise density improvement against additional power consumption. Figure 7-45 shows the internal block diagrams for the digital averaging modes. In averaging mode the output resolution is increased to 16-bit to avoid quantization noise limitation.

In 2x averaging mode (left), one external input is connected to the INx1 input where two ADC cores internally average the input signal. In 4x averaging (right), the signal has to be split externally and connected to both the INx1 and INx2 inputs where four ADC cores internally average the signal.

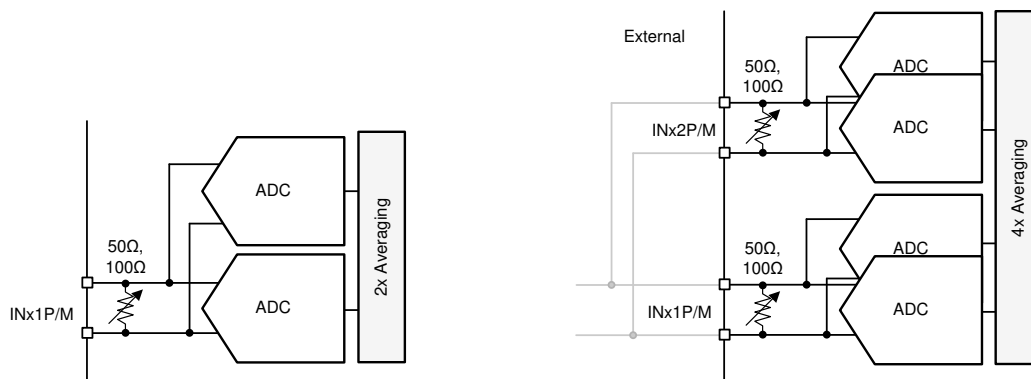

Figure 7-45. Internal digital averaging (left: 2x, right: 4x)

Table 7-48 provides a trade-off comparison of the 3 different averaging mode options vs the default, non-averaged mode.

Table 7-48. Digital Averaging vs Full Power Input Bandwidth (–3 dB)

# of ADCs averaged	ADC inputs used for averaging	Input Bandwidth (–3 dB)	Selected differential input termination	Noise density	Power/ch (W)
Default	INx1	2.75 GHz	100 Ω	-156 dBFS/Hz	~2.1
2	INx1	2.75 GHz	100 Ω	-158 dBFS/Hz	~2.6
4	INx1, INx2	2.1 GHz	100 Ω	-160 dBFS/Hz	~3.5

Digital averaging improves decorrelated noise contributions by 3 dB per 2x AVG (ideal) while correlated noise does not improve with averaging. Some of the dominant noise sources are correlated, that is, clock jitter (external or first clock input buffer), or power supply noise. While others (such as, ADC thermal noise, clock distribution buffers) are decorrelated. Table 7-49 illustrates a performance example comparison across averaging options.

SNR: When operating close to ADC fullscale, some of the SNR limitation is due to jitter and hence the SNR improvement will not reach 3 dB (2x AVG) or 6 dB (4x AVG). As the input fullscale is reduced, the clock jitter contribution to SNR becomes less and the SNR improvement is approaching the ideal 3 dB per 2x AVG. The same phenomenon can be observed when using digital decimation. As the decimation factor increases, the close-in (correlated noise) becomes the more dominating noise unless the input signal amplitude is reduced.

SFDR: The amplitude of low order harmonics (HD2-HD5) and IMD3 typically is similar across ADCs; thus, the improvement with averaging is small.

Table 7-49. Performance Comparison Example with 1x/2x/4x Averaging with $F_S = 2.6$ GSPS, $F_{IN} = 1$ GHz and Dither EN

Parameter	Input Amplitude (dBFS)	1x AVG	2x AVG	4x AVG
SNR (dBFS)	-4	62.8	64.9	67.2
	-10	63.9	66.3	68.2
	-20	64.0	66.4	69.4
HD2 (dBc)	-4	66	62	71
	-10	74	74	75
	-20	70	70	80
HD3 (dBc)	-4	73	76	78
	-10	80	78	80
	-20	74	71	72
Non HD23 (dBFS)	-4	86	84	83
	-10	90	91	92
	-20	96	100	97
IMD3 (dBc)	-10 dBFS/tone	77	73	71
	-20 dBFS/tone	78	79	72

7.5 Programming

The device is primarily configured and controlled using the serial programming interface (SPI); however, it can operate in a default configuration without requiring the SPI interface. Furthermore, the power down function as well as NCO frequency hopping or JESD synchronization are possible via pin control (GPIO1/2 pins).

7.5.1 GPIO Pin Control

There are several commands which can be executed using SPI programming or GPIO pins. [Table 7-50](#) provides an overview of the commands available using GPIO pins.

Table 7-50. GPIO Pin Command Options

FEATURE	DESCRIPTION
JESD SYNC	Support for single ended CMOS or differential LVDS
NCO Control	Fast frequency hopping with 3 different control options
Fast Overage	GPIO1 indicates overrange for channel A and GPIO2 for channel B. In this mode the overrange indication is 'sticky' - the flag stays high until it is cleared using SPI commands.
Calibration Freeze	Freezes swapping of calibration ADC

7.5.2 Configuration Using the SPI Interface

The device has a set of internal registers that can be accessed by the serial interface formed by the SEN (serial interface enable), SCLK (serial interface clock) and SDIO (serial interface data input/output) pins. Serially shifting bits into the device is enabled when SEN is low. Serial data input are latched at every SCLK rising edge when SEN is active (low). The serial data are loaded into the register at every 24th SCLK rising edge when SEN is low. When the word length exceeds a multiple of 24 bits, the excess bits are ignored. Data can be loaded in multiples of 24-bit words within a single active SEN pulse. The interface can function with SCLK frequencies from 20 MHz down to ~ 1 MHz and also with a non-50% SCLK duty cycle.

7.5.2.1 Register Write

The internal registers can be programmed following these steps:

1. Drive the SEN pin low
2. Set the R/W bit to 0 (bit A15 of the 16-bit address) and bits A[14:12] in address field to 0.
3. Initiate a serial interface cycle by specifying the address of the register (A[11:0]) whose content is written and
4. Write the 8-bit data that are latched in on the SCLK rising edges

Figure 7-46 shows the timing requirements for the serial register write operation.

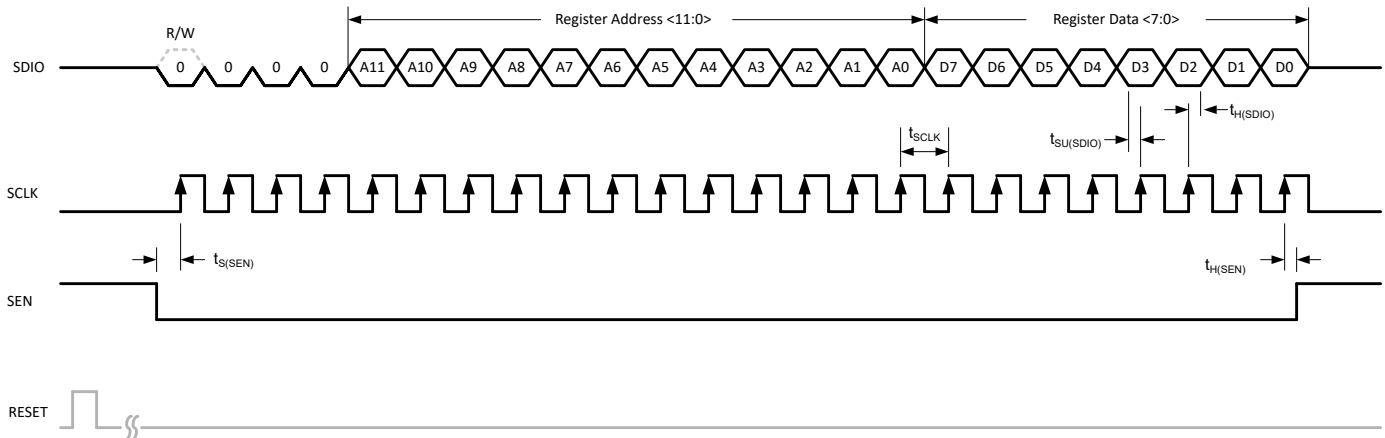

Figure 7-46. Serial Register Write Timing Diagram

7.5.2.2 Register Read

The device includes a mode where the contents of the internal registers can be read back using the SDIO pin. This readback mode can be useful as a diagnostic check to verify the serial interface communication between the external controller and the ADC. The procedure to read the contents of the serial registers is as follows:

1. Drive the SEN pin low
2. Set the R/W bit (A15) to 1. This setting disables any further writes to the registers. Set A[14:12] in address field to 0.
3. Initiate a serial interface cycle specifying the address of the register (A[11:0]) whose content must be read
4. The device outputs the contents (D[7:0]) of the selected register on the SDIO pin
5. The external controller can latch the contents at the SCLK falling edge

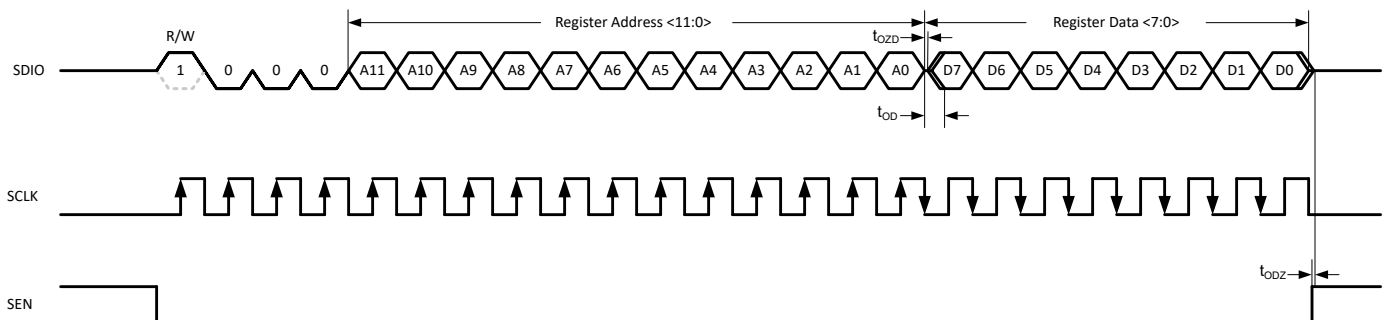

Figure 7-47. Serial Register Read Timing Diagram

7.6 Register Maps

Table 7-51. Register Map Summary

PAGE	REGISTER ADDRESS	REGISTER DATA							
	A[11:0]	D7	D6	D5	D4	D3	D2	D1	D0
GLOBAL	0x00	0	0	0	0	0	0	0	RESET
	0x05	MEM PAGE	ANALOG PAGE	CALIB PAGE	DDCB PAGE	DDCA PAGE	JESD PAGE	DIGITAL PAGE	0
DIGITAL	0x2C	20-BIT OUT	DDC BAND SEL		0	0	0	DDC REAL	BYP EN
	0x2D	0	DECIMATION			0	0	0	0
	0x2E	0	0	0	0	AVG EN	AVG SEL(1)		0
	0x33	0	0	0	1	FORMAT	0	GBL PDN	0
	0x34	0	MEM STROBE	MEM CH SEL		0	0	0	0
	0x3B	NCO4 CHA [1:0]		NCO3 CHA [1:0]		NCO2 CHA [1:0]		NCO1 CHA [1:0]	
	0x41	NCO4 CHB [1:0]		NCO3 CHB [1:0]		NCO2 CHB [1:0]		NCO1 CHB [1:0]	
	0x22F	1	SYSREF X5	SYSREF X4	SYSREF X3	SYSREF X2	SYSREF X1	SYSREF OR	1
	0x234	0	NCO SEL MODE		0	0	GPIO MODE		
	0x235	NCO SEL SOURCE							
	0x236	0	GPIO2 INV	GPIO1 INV	GPIO SWAP	0	0	SYSREF RESET	SYSREF EN
	0x237	0	0	0	0	0	GPIO2 CFG	0	GPIO1 CFG
	0x238	OVR OUTPUT CFG				0	0	0	0
	JESD	0x20	K						
0x21		0	SYNC SPI EN	SYNC SPI	0	0	SYSREF MODE		
0x22		LMFS MODE							
0x24		DDC CLK DIV							
0x25		JESD TX CLK DIV							
0x27		0	0	DROP LSB	0	0	0	CLK BAL EN	0
0x28		JESD TX LANE EN							
0x2B		0	0	0	0	0	0	0	SYNC INV
0x2D		0	0	0	0	0	TEST SEQ SEL		
0x2E		RAMP INCR				0	RAMP EN	ALT PAT	0
0x2F	0	PRBS PAT		PRBS EN	0	0	0	0	

Table 7-51. Register Map Summary (continued)

PAGE	REGISTER ADDRESS	REGISTER DATA								
	A[11:0]	D7	D6	D5	D4	D3	D2	D1	D0	
JESD	0x30	START VALUE JESD RAMP DOUT0								
	0x32	START VALUE JESD RAMP DOUT1								
	0x34	START VALUE JESD RAMP DOUT2								
	0x36	START VALUE JESD RAMP DOUT3								
	0x40	START VALUE JESD RAMP DOUT4								
	0x42	START VALUE JESD RAMP DOUT5								
	0x44	START VALUE JESD RAMP DOUT6								
	0x46	START VALUE JESD RAMP DOUT7								
	0x53	SCR EN	0	0	0	0	0	0	0	
	0x7A	JESD LANE POL INV								
	0x80	0	LANE DOUT1 SEL			0	LANE DOUT0 SEL			
	0x81	0	LANE DOUT3 SEL			0	LANE DOUT2 SEL			
	0x82	0	LANE DOUT5 SEL			0	LANE DOUT4 SEL			
	0x83	0	LANE DOUT7 SEL			0	LANE DOUT6 SEL			
	0x84	0	0	0	0	0	0	JESD PLL FACTOR		
	0x89	TX EMPH DOUT1 [0]	TX EMPH DOUT0 [5:0]						0	
	0x8A	0	0	0	TX EMPH DOUT1 [5:1]					
	0x8B	TX EMPH DOUT3 [0]	TX EMPH DOUT2 [5:0]						0	
	0x8C	0	0	0	TX EMPH DOUT3 [5:1]					
	0x8D	TX EMPH DOUT5 [0]	TX EMPH DOUT4 [5:0]						0	
	0x8E	0	0	0	TX EMPH DOUT5 [5:1]					
	0x8F	TX EMPH DOUT7 [0]	TX EMPH DOUT6 [5:0]						0	
	0x90	0	0	0	TX EMPH DOUT7 [5:1]					
	0x9D	PD DOUT7 [0]	PD DOUT6 [0]	PD DOUT5 [0]	PD DOUT4 [0]	PD DOUT3 [0]	PD DOUT2 [0]	PD DOUT1 [0]	PD DOUT0 [0]	
	0x9E	PD DOUT7 [1]	PD DOUT6 [1]	PD DOUT5 [1]	PD DOUT4 [1]	PD DOUT3 [1]	PD DOUT2 [1]	PD DOUT1 [1]	PD DOUT0 [1]	
	0x9F	0	JESD PLL1			0	JESD PLL2			
	0xA0	0	JESD PLL INPUT1			0	0	0	0	
	0xA1	0	JESD PLL INPUT2			0	0	0	0	
	0xA2	0	0	0	0	JESD PLL INPUT3			0	

Table 7-51. Register Map Summary (continued)

PAGE	REGISTER ADDRESS	REGISTER DATA							
	A[11:0]	D7	D6	D5	D4	D3	D2	D1	D0
DDCA/B	0x100..0x105	NCO1 FREQUENCY1 [7:0],[15:8],[23:16],[31:24],[39:32],[47:40]							
	0x108..0x10D	NCO1 FREQUENCY2 [7:0],[15:8],[23:16],[31:24],[39:32],[47:40]							
	0x110..0x115	NCO1 FREQUENCY3 [7:0],[15:8],[23:16],[31:24],[39:32],[47:40]							
	0x118..0x11D	NCO1 FREQUENCY4 [7:0],[15:8],[23:16],[31:24],[39:32],[47:40]							
	0x120..0x125	NCO2 FREQUENCY1 [7:0],[15:8],[23:16],[31:24],[39:32],[47:40]							
	0x128..0x12D	NCO2 FREQUENCY2 [7:0],[15:8],[23:16],[31:24],[39:32],[47:40]							
	0x130..0x135	NCO2 FREQUENCY3 [7:0],[15:8],[23:16],[31:24],[39:32],[47:40]							
	0x138..0x13D	NCO2 FREQUENCY4 [7:0],[15:8],[23:16],[31:24],[39:32],[47:40]							
	0x140..0x145	NCO3 FREQUENCY1 [7:0],[15:8],[23:16],[31:24],[39:32],[47:40]							
	0x148..0x14D	NCO3 FREQUENCY2 [7:0],[15:8],[23:16],[31:24],[39:32],[47:40]							
	0x150..0x155	NCO3 FREQUENCY3 [7:0],[15:8],[23:16],[31:24],[39:32],[47:40]							
	0x158..0x15D	NCO3 FREQUENCY4 [7:0],[15:8],[23:16],[31:24],[39:32],[47:40]							
	0x160..0x165	NCO4 FREQUENCY1 [7:0],[15:8],[23:16],[31:24],[39:32],[47:40]							
	0x168..0x16D	NCO4 FREQUENCY2 [7:0],[15:8],[23:16],[31:24],[39:32],[47:40]							
	0x170..0x175	NCO4 FREQUENCY3 [7:0],[15:8],[23:16],[31:24],[39:32],[47:40]							
	0x178..0x17D	NCO4 FREQUENCY4 [7:0],[15:8],[23:16],[31:24],[39:32],[47:40]							
		0x180	0	0	DDC PDN	DDC DITH PDN	REAL DDC	DB/QB DDC	0
	0x181	0	0	LOAD NCO		0	0	0	0
CALIBRATION	0x34	0	0	0	0	0	AVG SEL(2)		1
	0x45	CAL SPI	CAL GPIO	0	0	1	0	1	0
	0x298	0	0	0	0	CAL STATUS			
ANALOG	0x6D	RESET SW [1:0]		0	0	0	0	0	0
	0x6E	0	0	0	0	0	RESET SW [3:2]		
	0x7B	0	0	TERM A	0	0	0	0	TERM A
	0x8B	0	0	TERM B	0	0	0	0	TERM B
	0xA8	0	DITHER AMP1				0	0	0
	0xAF	DITHER DIS	0	0	1	0	0	0	0
	0xB1	DITHER DIVIDER							
	0xB4	0	0	0	0	0	0	0	SYSREF AC EN
	0xCD	0	DITH AMP2				0	0	0
	0xE6	TX SWING [0]	0	0	0	0	0	0	0
	0xE7	0	0	0	0	0	TX SWING [2:1]		

7.6.1 Detailed Register Description

Figure 7-48. Register 0x00

7	6	5	4	3	2	1	0
0	0	0	0	0	0	0	RESET
R/W-0	R/W-0	R/W-0	R/W-0	R/W-0	R/W-0	R/W-0	R/W-0

Table 7-52. Register 0x00 Field Descriptions

Bit	Field	Type	Reset	Description
7-1	0	R/W	0	Must write 0
0	RESET	R/W	0	This bit resets all internal registers to the default values. Does not self clear to 0.

Figure 7-49. Register 0x05

7	6	5	4	3	2	1	0
MEM PAGE	ANALOG PAGE	CALIB PAGE	DDCB PAGE	DDCA PAGE	JESD PAGE	DIGITAL PAGE	0
R/W-0	R/W-0	R/W-0	R/W-0	R/W-0	R/W-0	R/W-0	R/W-0

Table 7-53. Register 0x05 Field Descriptions

Bit	Field	Type	Reset	Description
7	MEM PAGE	R/W	0	This bit enables access to the MEMORY page 0: MEMORY page access disabled 1: MEMORY page access enabled
6	ANALOG PAGE	R/W	0	This bit enables access to the ANALOG page 0: ANALOG page access disabled 1: ANALOG page access enabled
5	CALIB PAGE	R/W	0	This bit enables access to the CALIBRATION page 0: CALIBRATION page access disabled 1: CALIBRATION page access enabled
4	DDCB PAGE	R/W	0	This bit enables access to the DDCB page. Contents can be written to DDCA and DDCB page simultaneously if it is identical. 0: DDCB page access disabled 1: DDCB page access enabled.
3	DDCA PAGE	R/W	0	This bit enables access to the DDCA page. Contents can be written to DDCA and DDCB page simultaneously if it is identical. 0: DDCA page access disabled 1: DDCA page access enabled
2	JESD PAGE	R/W	0	This bit enables access to the JESD page 0: JESD page access disabled 1: JESD page access enabled
1	DIGITAL PAGE	R/W	0	This bit enables access to the DIGITAL page 0: DIGITAL page access disabled 1: DIGITAL page access enabled
0	0	R/W	0	Must write 0

Figure 7-50. Register 0x2C (DIGITAL page)

7	6	5	4	3	2	1	0
20-BIT OUT	DDC BAND SEL		0	0	0	DDC REAL	BYP EN
R/W-0	R/W-0	R/W-0	R/W-0	R/W-0	R/W-0	R/W-0	R/W-0

Table 7-54. Register 0x2C Field Descriptions

Bit	Field	Type	Reset	Description
7	20-BIT OUT	R/W	0	This bit enables the 20-bit output mode. It carries the output sample with 20-bit output resolution from the DDC and the sample is filled to 32-bit with 12 trailing 0s. 0: Normal operation 1: 20-bit output mode
6-5	DDC BAND SEL	R/W	00	Selects 1, 2 or 4 DDC per ADC when complex decimation is enabled 0: Single band 1: Dual band 2: Quad band 3: not used
4-2	0	R	0	Must write 0
1	DDC REAL	R/W	0	This bit enables real decimation filter (NCO = 0). BYP EN (D0) must be set to 0. 0: Complex decimation 1: Real decimation
0	BYP EN	R/W	0	This bit enables DDC bypass mode 0: Decimation filter enabled. Complex decimation by default unless D1 is set 1: Decimation filter bypass

Figure 7-51. Register 0x2D (DIGITAL page)

7	6	5	4	3	2	1	0
0	DECIMATION			0	0	0	0
R/W-0	R/W-0	R/W-0	R/W-0	R/W-0	R/W-0	R/W-0	R/W-0

Table 7-55. Register 0x2D Field Descriptions

Bit	Field	Type	Reset	Description
7	0	R/W	0	Must write 0
6-4	DECIMATION	R/W	0	Selects decimation. 0,1: not used 2: Decimation by 4 3: Decimation by 8 4: Decimation by 16 5: Decimation by 32 6: Decimation by 64 7: Decimation by 128
3-0	0	R/W	0	Must write 0

Figure 7-52. Register 0x2E (DIGITAL page)

7	6	5	4	3	2	1	0
0	0	0	0	AVG EN	AVG SEL (1)		0
R/W-0	R/W-0	R/W-0	R/W-0	R/W-0	R/W-0	R/W-0	R/W-0

Table 7-56. Register 0x2E Field Descriptions

Bit	Field	Type	Reset	Description
7-4	0	R/W	0	Must write 0
3	AVG EN	R/W	0	This bit enables averaging 0: no average 1: ADC averaging enabled
2-1	AVG SEL (1)	R/W	00	Selects ADC averaging. Also AVG SEL (2) in CALIBRATION page needs to be set. 0: no average 1: 2 ADC average 2: 4 ADC average
0	0	R/W	0	Must write 0

Figure 7-53. Register 0x33 (DIGITAL page)

7	6	5	4	3	2	1	0
0	0	0	1	FORMAT	0	GBL PDN	0
R/W-0	R/W-0	R/W-0	R/W-0	R/W-0	R/W-0	R/W-0	R/W-0

Table 7-57. Register 0x33 Field Descriptions

Bit	Field	Type	Reset	Description
7-5	0	R/W	0	Must write 0
4	1	R/W	0	Must write 1
3	FORMAT	R/W	0	This register bit determines the output data format in DDC bypass mode only. 0: Offset Binary 1: 2s Complement DDC mode only supports 2s complement output format.
2	0	R/W	0	Must write 0
1	GBL PDN	R/W	0	This register bit enables global power down mode 0: normal operation 1: global power down mode enabled
0	0	R/W	0	Must write 0

Figure 7-54. Register 0x34 (DIGITAL page)

7	6	5	4	3	2	1	0
0	MEM STROBE	MEM CH SEL		0	0	0	0
R/W-0	R/W-0	R/W-0	R/W-0	R/W-0	R/W-0	R/W-0	R/W-0

Table 7-58. Register 0x34 Field Descriptions

Bit	Field	Type	Reset	Description
7	0	R/W	0	Must write 0
6	MEM STROBE	R/W	0	This register enables fast power down mode 0: normal operation 1: fast power down mode enabled

Table 7-58. Register 0x34 Field Descriptions (continued)

Bit	Field	Type	Reset	Description
5-4	MEM CH SEL	R/W	0	This register selects which ADC channel is used to fill up the capture sample buffer. Only 1 channel can be selected at a time and the samples are captured from the ADC core without averaging or decimation. 00: capture memory is filled from chA1 input 01: capture memory is filled from chA2 input 10: capture memory is filled from chB1 input 11: capture memory is filled from chB2 input
0	0	R/W	0	Must write 0

Figure 7-55. Register 0x3B (DIGITAL page)

7	6	5	4	3	2	1	0
NCO4 CHA [1:0]		NCO3 CHA [1:0]		NCO2 CHA [1:0]		NCO1 CHA [1:0]	
R/W-0	R/W-0	R/W-0	R/W-0	R/W-0	R/W-0	R/W-0	R/W-0

Table 7-59. Register 0x3B Field Descriptions

Bit	Field	Type	Reset	Description
7-6	NCO4 CHA [1:0]	R/W	00	This register is used when selecting the NCO frequency for channel A, band 4 with the SPI interface in quad DDC mode.
5-4	NCO3 CHA [1:0]	R/W	00	This register is used when selecting the NCO frequency for channel A, band 3 with the SPI interface in quad DDC mode.
3-2	NCO2 CHA [1:0]	R/W	00	In single band DDC mode this register is used to select between NCO bank 1 or 2. 00: NCO bank 1 01: NCO bank 2 In dual band DDC mode this register is used to select the NCO frequency for channel A, band 2 with the SPI interface.
1-0	NCO1 CHA [1:0]	R/W	00	This register is used when selecting the NCO1 of channel A with the SPI interface.

Figure 7-56. Register 0x41 (DIGITAL page)

7	6	5	4	3	2	1	0
NCO4 CHB [1:0]		NCO3 CHB [1:0]		NCO2 CHB [1:0]		NCO1 CHB [1:0]	
R/W-0	R/W-0	R/W-0	R/W-0	R/W-0	R/W-0	R/W-0	R/W-0

Table 7-60. Register 0x41 Field Descriptions

Bit	Field	Type	Reset	Description
7-6	NCO4 CHB [1:0]	R/W	00	This register is used when selecting the NCO frequency for channel B, band 4 with the SPI interface in quad DDC mode.
5-4	NCO3 CHB [1:0]	R/W	00	This register is used when selecting the NCO frequency for channel B, band 3 with the SPI interface in quad DDC mode.
3-2	NCO2 CHB [1:0]	R/W	00	In single band DDC mode this register is used to select between NCO bank 1 or 2 of channel B. 00: NCO bank 1 01: NCO bank 2 In dual band DDC mode this register is used to select the NCO frequency for channel B, band 2 with the SPI interface.
1-0	NCO1 CHB [1:0]	R/W	00	This register is used when selecting the NCO1 of channel B with the SPI interface.

Figure 7-57. Register 0x22F (DIGITAL page)

7	6	5	4	3	2	1	0
1	SYSREF X5	SYSREF X4	SYSREF X3	SYSREF X2	SYSREF X1	SYSREF OR	1
R/W-0	R/W-0	R/W-0	R/W-0	R/W-0	R/W-0	R/W-0	R/W-0

Table 7-61. Register 0x22F Field Descriptions

Bit	Field	Type	Reset	Description
7	1	R/W	1	Must write 1
6-2	SYSREF X1..5	R/W	0	These bits are the XOR flags from the SYSREF window monitoring circuitry. The sampling clock gets delayed internally by ~ 160 ps and used to capture the SYSREF signal. If a SYSREF signal transition happens within +/- 50 ps of the SYSREF capture the appropriate XOR flag gets raised. These bits are not sticky - they get overwritten with the next SYSREF rising edge. X1: Window from 110 ps to 135 ps after the rising sampling clock edge X2: Window from 135 ps to 160 ps after the rising sampling clock edge X3: Window from 160 ps to 176 ps after the rising sampling clock edge X4: Window from 176 ps to 192 ps after the rising sampling clock edge X5: Window from 192 ps to 208 ps after the rising sampling clock edge 0: No SYSREF transition detected 1: SYSREF transition detected within given window
1	SYSREF OR	R/W	0	This bit is the output of the five SYSREF XOR flags logically OR'ed together. 0: no SYSREF flag raised 1: one of the five SYSREF XOR flags is raised.
0	1	R/W	1	Must write 1

Figure 7-58. Register 0x234 (DIGITAL page)

7	6	5	4	3	2	1	0
0	NCO SEL MODE			0	0	GPIO MODE	
R/W-0	R/W-0	R/W-0	R/W-0	R/W-0	R/W-0	R/W-0	R/W-0

Table 7-62. Register 0x234 Field Descriptions

Bit	Field	Type	Reset	Description
7	0	R/W	0	Must write 0
6-5	NCO SEL MODE	R/W	00	These bits select control of the NCO selection in complex decimation. 0: NCO selection using GPIO pins (GPIO MODE (D2-D0) needs to be set accordingly) 2: GPIO1/2 pins are used as a fast serial interface only for the NCO selection for each digital mixer 3: GPIO1/2, SCLK, SDIO pins are used for NCO selection. others: not used Register 0x235 may need to be set as well.
4-3	0	R/W	0	Must write 0
2-0	GPIO MODE	R/W	000	This register sets the functionality of the two GPIO pins 0: GPIO pins are used as SYNC input (LVDS), GPIO1 = SYNC, GPIO2 = SYNCM 1: GPIO1 is used as SYNC input (CMOS) 3: Both GPIO pins are used to select NCOs for the decimation filters 4: GPIO1 is used to disable the calibration 5: GPIO1 is used as start of SYSREF counter others: not used

Figure 7-59. Register 0x235 (DIGITAL page)

7	6	5	4	3	2	1	0
NCO SEL SOURCE							
R/W-0	R/W-0	R/W-0	R/W-0	R/W-0	R/W-0	R/W-0	R/W-0

Table 7-63. Register 0x235 Field Descriptions

Bit	Field	Type	Reset	Description
7-0	NCO SEL SOURCE	R/W	0	This register works in conjunction with NCO SEL MODE (0x234). 0x00: NCO selection other than regular SPI (GPIO, Fast SPI etc) 0xFF: NCO selection using regular SPI with addresses 0x3B/41.

Figure 7-60. Register 0x236 (DIGITAL page)

7	6	5	4	3	2	1	0
0	GPIO2 INV	GPIO1 INV	GPIO SWAP	0	0	SYSREF RESET	SYSREF EN
R/W-0	R/W-0	R/W-0	R/W-0	R/W-0	R/W-0	R/W-0	R/W-0

Table 7-64. Register 0x236 Field Descriptions

Bit	Field	Type	Reset	Description
7	0	R/W	0	Must write 0
6	GPIO2 INV	R/W	0	This bit inverts polarity of the GPIO2 pin 0: Polarity as is 1: Polarity inverted
5	GPIO1 INV	R/W	0	This bit inverts polarity of the GPIO1 pin 0: Polarity as is 1: Polarity inverted
4	GPIO SWAP	R/W	0	This bit swaps GPIO1 and GPIO2 pins internally. 0: Normal operation 1: GPIO1 and GPIO2 are swapped
3-2	0	R/W	0	Must write 0
1	SYSREF RESET	R/W	0	This bit enables and clears the internal SYSREF counter: 0: Normal operation 1: Enables SYSREF and clears the internal counter
0	SYSREF EN	R/W	0	This bit starts the internal SYSREF counter: 0: Normal operation 1: Starts SYSREF counter

Figure 7-61. Register 0x237 (DIGITAL page)

7	6	5	4	3	2	1	0
0	0	0	0	0	GPIO2 CFG	0	GPIO1 CFG
R/W-0	R/W-0	R/W-0	R/W-0	R/W-0	R/W-0	R/W-0	R/W-0

Table 7-65. Register 0x237 Field Descriptions

Bit	Field	Type	Reset	Description
7-3	0	R/W	0	Must write 0
2	GPIO2 CFG	R/W	0	This bit configures GPIO2 pin either as input or output. 0: GPIO2 pin is input 1: GPIO2 pin is output
1	0	R/W	0	Must write 0
0	GPIO1 CFG	R/W	0	This bit configures GPIO1 pin either as input or output. 0: GPIO1 pin is input 1: GPIO1 pin is output

Figure 7-62. Register 0x238 (DIGITAL page)

7	6	5	4	3	2	1	0
OVR OUTPUT CFG				0	0	0	0
R/W-0	R/W-0	R/W-0	R/W-0	R/W-0	R/W-0	R/W-0	R/W-0

Table 7-66. Register 0x238 Field Descriptions

Bit	Field	Type	Reset	Description
7-4	OVR OUTPUT CFG	R/W	0000	This bit configures if the overrange indication (OVR) is output on JESD output stream or on GPIO pins 0000: OVR on JESD 1111: OVR on GPIO
3-0	0	R/W	0	Must write 0

Figure 7-63. Register 0x20 (JESD page)

7	6	5	4	3	2	1	0
K							
R/W-0	R/W-0	R/W-0	R/W-0	R/W-0	R/W-0	R/W-0	R/W-0

Table 7-67. Register 0x20 Field Descriptions

Bit	Field	Type	Reset	Description
7-0	K	R/W	00000000	This is JESD204B parameter K which sets number of frames in a multi-frame. Bit value is set as K minus 1.

Figure 7-64. Register 0x21 (JESD page)

7	6	5	4	3	2	1	0
0	SYNC SPI EN	SYNC SPI	0	0	SYSREF MODE		
R/W-0	R/W-0	R/W-0	R/W-0	R/W-0	R/W-0	R/W-0	R/W-0

Table 7-68. Register 0x21 Field Descriptions

Bit	Field	Type	Reset	Description
7	0	R/W	0	Must write 0
6	SYNC SPI EN	R/W	0	This bit enables JESD SYNC control using SPI (ignoring SYNC using GPIO1/2 pins) using bit D5 (SYNC SPI). 0: SPI SYNC disabled 1: SPI SYNC (using register bit D5) enabled
5	SYNC SPI	R/W	0	This bit enables JESD SYNC. SYNC control via SPI must be enabled also (D6). 0: ADC outputs data (SYNC disabled) 1: SYNC enabled (ADC outputs K28.5 characters for JESD interface synchronization)
4-3	0	R/W	0	Must write 0
2-0	SYSREF MODE	R/W	000	This register controls how the ADC processes incoming SYSREF pulses. 0: Ignore all SYSREF pulses 1: Use all SYSREF pulses 2: Don't use SYSREF pulses 3: Skip one SYSREF pulse then use only the next one 4: Skip one SYSREF pulse then use all pulses 5: Skip two SYSREF pulses and then use one 6: Skip two SYSREF pulses and then use all

Figure 7-65. Register 0x22 (JESD page)

7	6	5	4	3	2	1	0
JESD MODE							
R/W-0	R/W-0	R/W-0	R/W-0	R/W-0	R/W-0	R/W-0	R/W-0

Table 7-69. Register 0x22 Field Descriptions

Bit	Field	Type	Reset	Description
7:0	JESD MODE	R/W	00000000	This register sets the LMFS configuration 0: LMFS = 8-2-8-20 (also bit DROP LSB in 0x27 needs to be set) 1: LMFS = 8-2-2-4 3: LMFS = 8-4-2-2 4: LMFS = 8-16-4-1 5: LMFS = 4-16-8-1 6: LMFS = 2-16-16-1 7: LMFS = 1-16-32-1 8: LMFS = 8-8-2-1 9: LMFS = 4-8-4-1 10: LMFS = 2-8-8-1 11: LMFS = 1-8-16-1 12: LMFS = 4-4-2-1 13: LMFS = 2-4-4-1 14: LMFS = 1-4-8-1 15: LMFS = 2-2-2-1 16: LMFS = 1-2-4-1 others: not used

Figure 7-66. Register 0x24 (JESD page)

7	6	5	4	3	2	1	0
DDC CLK DIV							
R/W-0	R/W-0	R/W-0	R/W-0	R/W-0	R/W-0	R/W-0	R/W-0

Table 7-70. Register 0x24 Field Descriptions

Bit	Field	Type	Reset	Description
7:0	DDC CLK DIV	R/W	00000000	This register sets the internal clock divider when using the decimation filter. See Table 7-72 .

Figure 7-67. Register 0x25 (JESD page)

7	6	5	4	3	2	1	0
JESD TX CLK DIV							
R/W-0	R/W-0	R/W-0	R/W-0	R/W-0	R/W-0	R/W-0	R/W-0

Table 7-71. Register 0x25 Field Descriptions

Bit	Field	Type	Reset	Description
7:0	JESD TX CLK DIV	R/W	00000000	This register sets the internal clock divider for the selected LMFS output mode. See Table 7-72 for 16-bit and Table 7-73 for 20-bit output.

Table 7-72. Register Settings for 0x24/0x25 Based on Bypass/Decimation and LMFS Mode (16-bit Output)

LMFS	0x24 (DDC CLK DIV)							0x25 (JESD TX CLK DIV)						
	BYP	/4	/8	/16	/32	/64	/128	BYP	/4	/8	/16	/32	/64	/128
8-2-2-4	0							0						
8-2-8-20	0							4						
8-4-8-10	1							4						
8-4-2-2	1	0	0	0	0			0	1	1	1	1		
8-8-2-1		0	0	0	0	0	0		0	0	0	0	0	0
8-16-4-1		1	1	1	1	1	1		0	0	0	0	0	0
4-2-2-2		0	0	0	0	0	0		1	1	1	1	1	1
4-4-2-1		0	0	0	0	0	0		0	0	0	0	0	0
4-8-4-1		1	1	1	1	1	1		0	0	0	0	0	0
4-16-8-1		3	3	3	3	3	3		0	0	0	0	0	0
2-2-2-1		0	0	0	0	0	0		0	0	0	0	0	0
2-4-4-1		1	1	1	1	1	1		0	0	0	0	0	0
2-8-8-1		3	3	3	3	3	3		0	0	0	0	0	0
2-16-16-1			7	7	7	7	7			0	0	0	0	0
1-2-4-1		1	1	1	1	1	1		0	0	0	0	0	0
1-4-8-1		3	3	3	3	3	3		0	0	0	0	0	0
1-8-16-1			7	7	7	7	7			0	0	0	0	0
1-16-32-1				15	15	15	15				0	0	0	0

Table 7-73. Register Settings for 0x24/0x25 Based on Decimation and LMFS Mode (20-bit Output).

LMFS	0x24 (DDC CLK DIV)							0x25 (JESD TX CLK DIV)						
	BYP	/4	/8	/16	/32	/64	/128	BYP	/4	/8	/16	/32	/64	/128
8-8-4-1		1	1	1	1	1	1		0	0	0	0	0	0
8-16-8-1		3	3	3	3	3	3		0	0	0	0	0	0
4-4-4-1		1	1	1	1	1	1		0	0	0	0	0	0
4-8-8-1		3	3	3	3	3	3		0	0	0	0	0	0
4-16-16-1			7	7	7	7	7			0	0	0	0	0
2-2-4-1		1	1	1	1	1	1		0	0	0	0	0	0
2-4-8-1		3	3	3	3	3	3		0	0	0	0	0	0
2-8-16-1			7	7	7	7	7			0	0	0	0	0
2-16-32-1				15	15	15	15				0	0	0	0
1-2-8-1		3	3	3	3	3	3		0	0	0	0	0	0
1-4-16-1			7	7	7	7	7			0	0	0	0	0
1-8-32-1				15	15	15	15				0	0	0	0
1-16-64-1					31	31	31					0	0	0

Figure 7-68. Register 0x27 (JESD page)

7	6	5	4	3	2	1	0
0	0	DROP LSB	0	0	0	CLK BAL EN	0
R/W-0	R/W-0	R/W-0	R/W-0	R/W-0	R/W-0	R/W-0	R/W-0

Table 7-74. Register 0x27 Field Descriptions

Bit	Field	Type	Reset	Description
7-6	0	R/W	0	Must write 0
5	DROP LSB	R/W	0	This register needs to be set when using the 12-bit output LMFS mode. 0: Drop LSB disabled 1: Drop LSB enabled when using LMFS = 8-2-8-2-20
4-2	0	R/W	0	Must write 0
1	CLK BAL EN	R/W	0	This register bit needs to be enabled in bypass mode LMFS = 8-2-2-4 only in order to improve some internal clock balancing. 0: CLK BAL disabled 1: CLK BAL EN. Set for LMFS = 8-2-2-4
0	0	R/W	0	Must write 0

Figure 7-69. Register 0x28 (JESD page)

7	6	5	4	3	2	1	0
JESD LANE EN							
R/W-0	R/W-0	R/W-0	R/W-0	R/W-0	R/W-0	R/W-0	R/W-0

Table 7-75. Register 0x28 Field Descriptions

Bit	Field	Type	Reset	Description
7-0	JESD LANE EN	R/W	11111111	This register turns on individual output lanes 0: Lane powered down 1: Serdes lane enabled D0: Lane DOUT0 D1: Lane DOUT1 ... D7: Lane DOUT7

Figure 7-70. Register 0x2B

7	6	5	4	3	2	1	0
0	0	0	0	0	0	0	SYNC INV
R/W-0	R/W-0	R/W-0	R/W-0	R/W-0	R/W-0	R/W-0	R/W-0

Table 7-76. Register 0x2B Field Descriptions

Bit	Field	Type	Reset	Description
7-1	0	R/W	0	Must write 0
0	SYNC INV	R/W	0	This register inverts the polarity from external SYNC pin 0: Polarity as is 1: Polarity inverted

Figure 7-71. Register 0x2D (JESD page)

7	6	5	4	3	2	1	0
0	0	0	0	0	JESD SEQ SEL		
R/W-0	R/W-0	R/W-0	R/W-0	R/W-0	R/W-0	R/W-0	R/W-0

Table 7-77. Register 0x2D Field Descriptions

Bit	Field	Type	Reset	Description
7-3	0	R/W	0	Must write 0
2-0	JESD SEQ SEL	R/W	000	This register selects the JESD test pattern sequence 0: Test sequence disabled 1: Repeat D21.5 high frequency pattern for random jitter (RJ) 2: Repeat K28.5 mixed frequency pattern for deterministic jitter (DJ) 3: Repeat initial lane alignment (ILA) sequence 4: Modified random pattern 5: Scrambled jitter pattern 6: Repeat K28.7 low frequency pattern 7: Short test pattern

Figure 7-72. Register 0x2E (JESD page)

7	6	5	4	3	2	1	0
RAMP INCR				0	RAMP EN	ALT PAT	0
R/W-0	R/W-0	R/W-0	R/W-0	R/W-0	R/W-0	R/W-0	R/W-0

Table 7-78. Register 0x2E Field Descriptions

Bit	Field	Type	Reset	Description
7-4	RAMP INCR	R/W	0000	This register value sets the increment step size for the ramp pattern on 16-bit output. The step size is RAMP INCR plus 1.
3	0	R/W	0	Must write 0
2	RAMP EN	R/W	0	Enables RAMP output pattern in the TRANSPORT LAYER.
1	ALT PAT	R/W	0	Enables a toggle pattern switching between 0x0000 and 0xFFFF in the TRANSPORT LAYER
0	0	R/W	0	Must write 0

Figure 7-73. Register 0x2F (JESD page)

7	6	5	4	3	2	1	0
0	SERDES PRBS		SERDES PRBS EN	0	0	0	0
R/W-0	R/W-0	R/W-0	R/W-0	R/W-0	R/W-0	R/W-0	R/W-0

Table 7-79. Register 0x2F Field Descriptions

Bit	Field	Type	Reset	Description
7	0	R/W	0	Must write 0
6-5	SERDES PRBS	R/W	0	This register selects the PRBS pattern in the LINK LAYER (no 8b/10b encoding). PRBS pattern must be enabled (D4). 0: PRBS 2 ⁷ -1 1: PRBS 2 ¹⁵ -1 2: PRBS 2 ²³ -1 3: PRBS 2 ³¹ -1
4	SERDES PRBS EN	R/W	0	This register enables PRBS test pattern in the LINK LAYER 0: Test pattern mode disabled 1: PRBS test pattern mode enabled
3-0	0	R/W	0	Must write 0

Figure 7-74. Register 0x30/32/34/36/40/42/44/46 (JESD page)

7	6	5	4	3	2	1	0
START VALUE JESD RAMP DOUT0/1/2/3/4/5/6/7							
R/W-0	R/W-0	R/W-0	R/W-0	R/W-0	R/W-0	R/W-0	R/W-0

Table 7-80. Register 0x30/32/34/36/40/42/44/46 Field Descriptions

Bit	Field	Type	Reset	Description
7-0	START VALUE JESD RAMP DOUT0/1/2/3/4/5/6/7	R/W	00000000	The JESD RAMP test pattern is designed to act as an individual RAMP pattern on each output lane. If the starting value on each lane is set to 0 (default), each output lane shows the same RAMP code at any given time. The RAMP pattern can be configured such that the RAMP pattern is constructed across JESD output lanes using the start value registers. DOUT1=1, DOUT2=2, DOUT3=3, DOUT4=0, DOUT5=1, DOUT6=2 and DOUT7=3 as well as the RAMP increment to 4 (RAMP INCR (0x2E) = 0x30) results in a RAMP pattern across lanes for each channel in bypass mode.

Figure 7-75. Register 0x53 (JESD page)

7	6	5	4	3	2	1	0
SCR EN	0	0	0	0	0	0	0
R/W-0	R/W-0	R/W-0	R/W-0	R/W-0	R/W-0	R/W-0	R/W-0

Table 7-81. Register 0x53 Field Descriptions

Bit	Field	Type	Reset	Description
7	SCR EN	R/W	0	Enables scrambling of the JESD output data 0: Output scrambling disabled 1: Output scrambling enabled
6-0	0	R/W	0	Must write 0

Figure 7-76. Register 0x7A (JESD page)

7	6	5	4	3	2	1	0
JESD LANE POL INV							
R/W-0	R/W-0	R/W-0	R/W-0	R/W-0	R/W-0	R/W-0	R/W-0

Table 7-82. Register 0x7A Field Descriptions

Bit	Field	Type	Reset	Description
7-0	JESD LANE POL INV	R/W	00000000	This register inverts the polarity of the individual SERDES output lanes. Register bit D0 corresponds to SERDES lane DOUT0, D1 to DOUT1 etc 0: Output polarity as is 1: Output polarity inverted

Figure 7-77. Register 0x80/81/82/83 (JESD page)

ADDR	7	6	5	4	3	2	1	0
0x80	0	LANE DOUT1 SEL			0	LANE DOUT0 SEL		
0x81	0	LANE DOUT3 SEL			0	LANE DOUT2 SEL		
0x82	0	LANE DOUT5 SEL			0	LANE DOUT4 SEL		
0x83	0	LANE DOUT7 SEL			0	LANE DOUT6 SEL		
	R/W-0	R/W-0	R/W-0	R/W-0	R/W-0	R/W-0	R/W-0	R/W-0

Table 7-83. Register 0x80/81/82/83 Field Descriptions

Bit	Field	Type	Reset	Description
7,3	0	R/W	0	Must write 0
6-4	LANE DOUT1/3/5/7 SEL	R/W	000	These register bits control the output mux. Any physical serdes output lane (DOUTx) can be connected to any JESD digital stream. By default lane DOUT0 is connected to JESD stream 0, lane DOUT1 to JESD stream 1 etc. 0: JESD stream 0 1: JESD stream 1 ... 7: JESD stream 7
2-0	LANE DOUT0/2/4/6 SEL	R/W	000	

Figure 7-78. Register 0x84 (JESD page)

7	6	5	4	3	2	1	0
0	0	0	0	0	0	JESD PLL FACTOR	
R/W-0	R/W-0	R/W-0	R/W-0	R/W-0	R/W-0	R/W-0	R/W-0

Table 7-84. Register 0x84 Field Descriptions

Bit	Field	Type	Reset	Description
7-2	0	R/W	0	Must write 0
1-0	JESD PLL FACTOR	R/W	00	This register bit must be set for 12-bit output LMFS = 8-2-8-20 only. 0: all other JESD LMFS modes 1: Set for LMFS = 8-2-8-20

Figure 7-79. Register 0x89/8A/8B/8C/8D/8E/8F/90 (JESD page)

ADDR	7	6	5	4	3	2	1	0
0x89	TX EMPH DOUT1 [0]	TX EMPH DOUT0 [5:0]						0
0x8A	0	0	0	TX EMPH DOUT1 [5:1]				
0x8B	TX EMPH DOUT3 [0]	TX EMPH DOUT2 [5:0]						0
0x8C	0	0	0	TX EMPH DOUT3 [5:1]				
0x8D	TX EMPH DOUT5 [0]	TX EMPH DOUT4 [5:0]						0
0x8E	0	0	0	TX EMPH DOUT5 [5:1]				
0x8F	TX EMPH DOUT7 [0]	TX EMPH DOUT6 [5:0]						0
0x90	0	0	0	TX EMPH DOUT7 [5:1]				
	R/W-0	R/W-0	R/W-0	R/W-0	R/W-0	R/W-0	R/W-0	R/W-0

Table 7-85. Register 0x89/8A/8B/8C/8D/8E/8F/90 Field Descriptions

Bit	Field	Type	Reset	Description
7-5,0	0	R/W	0	Must write 0
6-1	TX EMPH DOUT0/2/4/6 [5:0]	R/W	000000	These bits select the amount of de-emphasis for the JESD output transmitter. The de-emphasis value in dB is measured as the ratio between the peak value after the signal transition to the settled value of the voltage in one bit period. 0: 0 dB 1: -1 dB 3: -2 dB 7: -4.1 dB 15: -6.2 dB 31: -8.2 dB 63: -11.5 dB
4-0,7	TX EMPH DOUT1/3/5/7 [5:0]	R/W	000000	

Figure 7-80. Register 0x9D/9E (JESD page)

7	6	5	4	3	2	1	0
PD DOUT7 [0,1]	PD DOUT6 [0,1]	PD DOUT5 [0,1]	PD DOUT4 [0,1]	PD DOUT3 [0,1]	PD DOUT2 [0,1]	PD DOUT1 [0,1]	PD DOUT0 [0,1]
R/W-0	R/W-0	R/W-0	R/W-0	R/W-0	R/W-0	R/W-0	R/W-0

Table 7-86. Register 0x9D/9E Field Descriptions

Bit	Field	Type	Reset	Description
7-0	PD DOUTx [0,1]	R/W	0	Register 0x9D and 0x9E allow power down of individual serdes output lanes. Register 0x9D (PD DOUTx [0]) covers the output driver, 0x9E (PD DOUTx [1]) covers the associated internal high-speed data clock. 0: Output lane enabled 1: Output lane powered down

Figure 7-81. Register 0x9F (JESD page)

7	6	5	4	3	2	1	0
0	JESD PLL1			0	JESD PLL2		
R/W-0	R/W-0	R/W-0	R/W-0	R/W-0	R/W-0	R/W-0	R/W-0

Table 7-87. Register 0x9F Field Descriptions

Bit	Field	Type	Reset	Description
7	0	R/W	0	Must write 0
6-4	JESD PLL1	R/W	000	Internal JESD PLL input divider setting. See Table 7-89 how to configure it for the different decimation and LMFS settings.
3	0	R/W	0	Must write 0
2-0	JESD PLL2	R/W	000	Internal JESD PLL input divider setting. See Table 7-89 how to configure it for the different decimation and LMFS settings.

Figure 7-82. Register 0xA0/A1/A2 (JESD page)

ADDR	7	6	5	4	3	2	1	0
0xA0	0	JESD PLL INPUT1			0	0	0	0
0xA1	0	JESD PLL INPUT2			0	0	0	0
0xA2	0	0	0	0	JESD PLL INPUT3			0
	R/W-0	R/W-0	R/W-0	R/W-0	R/W-0	R/W-0	R/W-0	R/W-0

Table 7-88. Register 0xA0/A1/A2 Field Descriptions

Bit	Field	Type	Reset	Description
7-0	0	R/W	0	Must write 0
6-4	JESD PLL INPUT1/2	R/W	000	Internal JESD PLL input divider setting. See Table 7-89 (16-bit output) and Table 7-89 (20-bit output) how to configure it for the different decimation and LMFS settings.
3-1	JESD PLL INPUT3	R/W	000	Internal JESD PLL input divider setting. See Table 7-89 (16-bit output) and Table 7-89 (20-bit output) how to configure it for the different decimation and LMFS settings.

Table 7-89. Register settings for 0x9F/A0/A1/A2 based on bypass/decimation and LMFS mode (16-bit output)

LMFS	0x9F[6:4], 0x9F[2:0], 0xA1[6:4]							0xA0[6:4]							0xA2[3:1]							
	BYP	/4	/8	/16	/32	/64	/128	BYP	/4	/8	/16	/32	/64	/128	BYP	/4	/8	/16	/32	/64	/128	
8-2-2-4	0							0							0							
8-2-8-20	0							0							0							
8-4-8-10	0							0							1							
8-4-2-2	0	1	2	3	3			0	0	1	2	2			1	0	0	0	2			
8-8-2-1		0	1	2	3	4	4		0	1	2	3	4	4		0	0	0	0	0	0	2
8-16-4-1		0	0	1	2	3	4		0	0	1	2	3	4		1	0	0	0	0	0	0
4-2-2-2		1	2	3					0	1	2					0						
4-4-2-1		0	1	2	3	4	4		0	1	2	3	4	4		0	0	0	0	0	0	2
4-8-4-1		0	0	1	2	3	4		0	0	1	2	3	4		1	0	0	0	0	0	0
4-16-8-1		0	0	0	1	2	3		0	0	0	1	2	3		3	1	0	0	0	0	0
2-2-2-1		0	1	2	3	4	4		0	1	2	3	4	4		0	0	0	0	0	0	2
2-4-4-1		0	0	1	2	3	4		0	0	1	2	3	4		0	0	0	0	0	0	0
2-8-8-1		0	0	0	1	2	3		0	0	0	1	2	3		3	1	0	0	0	0	0
2-16-16-1			0	0	0	1	2		0	0	0	1	2			3	1	0	0	0	0	0
1-2-4-1		0	0	1	2	3	4		0	0	1	2	3	4		1	0	0	0	0	0	0
1-4-8-1		0	0	0	1	2	3		0	0	0	1	2	3		3	1	0	0	0	0	0

Table 7-89. Register settings for 0x9F/A0/A1/A2 based on bypass/decimation and LMFS mode (16-bit output) (continued)

	0x9F[6:4], 0x9F[2:0], 0xA1[6:4]						0xA0[6:4]						0xA2[3:1]								
1-8-16-1			0	0	0	1	2			0	0	0	1	2			3	1	0	0	0
1-16-32-1				0	0	0	1				0	0	0	1				3	1	0	0

Table 7-90. Register settings for 0x9F/A0/A1/A2 based on decimation and LMFS mode (20-bit output)

	0x9F[6:4], 0x9F[2:0], 0xA1[6:4]						0xA0[6:4]						0xA2[3:1]					
LMFS	/4	/8	/16	/32	/64	/128	/4	/8	/16	/32	/64	/128	/4	/8	/16	/32	/64	/128
8-8-4-1	0	0	1	2	3	4	0	0	1	2	3	4	1	0	0	0	0	0
8-16-8-1	0	0	0	1	2	3	0	0	0	1	2	3	3	1	0	0	0	0
4-4-4-1	0	0	1	2	3	4	0	0	1	2	3	4	1	0	0	0	0	0
4-8-8-1	0	0	0	1	2	3	0	0	0	1	2	3	3	1	0	0	0	0
4-16-16-1		0	0	0	1	2		0	0	0	1	2		3	1	0	0	0
2-2-4-1	0	0	1	2	3	4	0	0	1	2	3	4	1	0	0	0	0	0
2-4-8-1	0	0	0	1	2	3	0	0	0	1	2	3	3	1	0	0	0	0
2-8-16-1		0	0	0	1	2		0	0	0	1	2		3	1	0	0	0
2-16-32-1			0	0	0	1			0	0	0	1			3	1	0	0
1-2-8-1	0	0	0	1	2	3	0	0	0	1	2	3	3	1	0	0	0	0
1-4-16-1		0	0	0	1	2		0	0	0	1	2		3	1	0	0	0
1-8-32-1			0	0	0	1			0	0	0	1			3	1	0	0
1-16-64-1				0	0	0				0	0	0				3	1	0

Figure 7-83. Register 0x100..0x17D (DDCA/B page)

7	6	5	4	3	2	1	0
NCOx FREQUENCYx [7:0],[15:8],[23:16],[31:24],[39:32],[47:40]							
R/W-0	R/W-0	R/W-0	R/W-0	R/W-0	R/W-0	R/W-0	R/W-0

Table 7-91. Register 0x100..0x17D Field Descriptions

Bit	Field	Type	Reset	Description
47:0	NCOx FREQUENCYx	R/W	0	The frequencies for NCOs are located in addresses 0x100 to 0x17D. Each frequency is 48-bit and the MSB starts on the highest address as illustrated in Section 7.3.5.6 .

Figure 7-84. Register 0x180 (DDCA/B page)

7	6	5	4	3	2	1	0
0	0	DDC PDN	DDC DITH PDN	REAL DDC	DB/QB DDC	0	NCO MODE
R/W-0	R/W-0	R/W-0	R/W-0	R/W-0	R/W-0	R/W-0	R/W-0

Table 7-92. Register 0x180 Field Descriptions

Bit	Field	Type	Reset	Description
7-6	0	R/W	0	Must write 0
5	DDC PDN	R/W	0	This bit powers down the DDC mixer and NCO 0: DDC block enabled 1: DDC block powered down
4	DDC DITH PDN	R/W	0	This bit powers down the dither in the DDC digital block 0: DDC dither enabled 1: DDC dither powered down
3	REAL DDC	R/W	0	Set this bit to 1 in real decimation mode to disable the NCO. 0: Complex Decimation 1: Real Decimation
2	DB/QB DDC	R/W	0	This register splits the NCOs for dual or quad band operation. 0: Dual Band 1: Quad Band
1	0	R/W	0	Must write 0
0	NCO MODE	R/W	0	This register selects phase coherent or phase continuous operation of the NCO. 0: Phase continuous 1: Phase coherent

Figure 7-85. Register 0x181 (DDCA/B page)

7	6	5	4	3	2	1	0
0	0	LOAD NCO		0	0	0	0
R/W-0	R/W-0	R/W-0	R/W-0	R/W-0	R/W-0	R/W-0	R/W-0

Table 7-93. Register 0x181 Field Descriptions

Bit	Field	Type	Reset	Description
7-6	0	R/W	0	Must write 0
5-4	LOAD NCO	R/W	00	This register loads all the NCO frequencies from the memory to the NCOs. To update the NCO this register has to be set to 3 and back to 0 as shown in Table 7-94 .
3-0	0	R/W	0	Must write 0

Table 7-94. NCO frequency programming example

ADDR	DATA	DESCRIPTION
0x105	0x4E	Frequency = 920 MHz with $F_S = 3$ GSPS 86,318,992,857,935 = 0x4E81B4E81BE4 where the MSB goes to address 0x105 and the LSB to 0x100.
0x104	0x81	
0x103	0xB4	
0x102	0xE8	
0x101	0x1B	
0x100	0x4E	
0x181	0x00	Load and update all NCO frequencies
0x181	0x30	

Figure 7-86. Register 0x34 (CALIBRATION page)

7	6	5	4	3	2	1	0
0	0	0	0	0	AVG SEL (2)		1
R/W-0	R/W-0	R/W-0	R/W-0	R/W-0	R/W-0	R/W-0	R/W-0

Table 7-95. Register 0x34 Field Descriptions

Bit	Field	Type	Reset	Description
7-3	0	R/W	0	Must write 0
2-1	AVG SEL (2)	R/W	00	Selects ADC averaging. Also AVG SEL (1) in DIGITAL page needs to be set. 0: no average 01: 2 ADC average 10: not used 11: 4 ADC average
0	1	R/W	1	Must write 1

Figure 7-87. Register 0x45 (CALIBRATION page)

7	6	5	4	3	2	1	0
CAL SPI	CAL GPIO	0	0	1	0	1	0
R/W-0	R/W-0	R/W-0	R/W-0	R/W-0	R/W-0	R/W-0	R/W-0

Table 7-96. Register 0x45 Field Descriptions

Bit	Field	Type	Reset	Description
7	CAL SPI	R/W	0	This register triggers the calibration using SPI write. It needs to be toggled (0=>1=>0).
6	CAL GPIO	R/W	0	This register triggers the calibration using the GPIO1 pin.
5-4	0	R/W	0	Must write 0
3	1	R/W	1	Must write 1
2	0	R/W	0	Must write 0
1	1	R/W	1	Must write 1
0	0	R/W	0	Must write 0

Figure 7-88. Register 0x298 (CALIBRATION page)

7	6	5	4	3	2	1	0
0	0	0	0	CAL STATUS			
R/W-0	R/W-0	R/W-0	R/W-0	R/W-0	R/W-0	R/W-0	R/W-0

Table 7-97. Register 0x298 Field Descriptions

Bit	Field	Type	Reset	Description
7-4	0	R/W	0	Must write 0
3-0	CAL STATUS	R/W	0000	This register can be used to check if calibration state machine has finished without any errors. A value of 0xE indicates successful calibration.

Figure 7-89. Register 0x6D/6E (ANALOG page)

7	6	5	4	3	2	1	0
RESET SW [1:0]		0	0	0	0	0	0
0	0	0	0	0	0	RESET SW [3:2]	
R/W-0	R/W-0	R/W-0	R/W-0	R/W-0	R/W-0	R/W-0	R/W-0

Table 7-98. Register 0x6D/6E Field Descriptions

Bit	Field	Type	Reset	Description
7-6	RESET SW [1:0]	R/W	00	This register disables the sampling reset switch. 00: Sampling reset switch enabled 1: Sampling reset switch disabled
5-0	0	R/W	0	Must write 0
1-0	RESET SW [3:2]	R/W	00	This register disables the sampling reset switch. 00: Sampling reset switch enabled 1: Sampling reset switch disabled
7-2	0	R/W	0	Must write 0

Figure 7-90. Register 0x7B (ANALOG page)

7	6	5	4	3	2	1	0
0	0	TERM A	0	0	0	0	TERM A
R/W-0	R/W-0	R/W-0	R/W-0	R/W-0	R/W-0	R/W-0	R/W-0

Table 7-99. Register 0x7B Field Descriptions

Bit	Field	Type	Reset	Description
7-6	0	R/W	0	Must write 0
5,0	TERM A	R/W	00	These registers set the internal termination resistor at the analog inputs for channel A1 and A2. Both registers need to be set to the same value. 0: 100 ohm differential termination 1: 50 ohm differential termination
4-1	0	R/W	0	Must write 0

Figure 7-91. Register 0x8B (ANALOG page)

7	6	5	4	3	2	1	0
0	0	TERM B	0	0	0	0	TERM B
R/W-0	R/W-0	R/W-0	R/W-0	R/W-0	R/W-0	R/W-0	R/W-0

Table 7-100. Register 0x8B Field Descriptions

Bit	Field	Type	Reset	Description
7-6	0	R/W	0	Must write 0
5,0	TERM B	R/W	00	These registers set the internal termination resistor at the analog inputs for channel B1 and B2. Both registers need to be set to the same value. 0: 100 ohm differential termination 1: 50 ohm differential termination
4-1	0	R/W	0	Must write 0

Figure 7-92. Register 0xA8 (ANALOG page)

7	6	5	4	3	2	1	0	
0	DITH AMP1					0	0	0
R/W-0	R/W-0	R/W-0	R/W-0	R/W-0	R/W-0	R/W-0	R/W-0	

Table 7-101. Register 0xA8 Field Descriptions

Bit	Field	Type	Reset	Description
7	0	R/W	0	Must write 0
6-3	DITH AMP1	R/W	0000	This register sets dither amplitude coarse gain. There are two recommended settings: 0000: Amplitude = 0 0011: Amplitude = 3 Here is a list of all the settings: 0000: Amplitude = 0 (smallest) 0001: Amplitude = 1 ... 1110: Amplitude = 14 1111: Amplitude = 15 (largest)
2-0	0	R/W	0	Must write 0

Figure 7-93. Register 0xAF (ANALOG page)

7	6	5	4	3	2	1	0
DITHER DIS	0	0	1	0	0	0	0
R/W-0	R/W-0	R/W-0	R/W-0	R/W-0	R/W-0	R/W-0	R/W-0

Table 7-102. Register 0xAF Field Descriptions

Bit	Field	Type	Reset	Description
7	DITHER DIS	R/W	0	This register disables internal dither. 0: Dither enabled 1: Dither disabled
6-5	0	R/W	0	Must write 0
4	1	R/W	0	Must write 1
3-0	0	R/W	0	Must write 0

Figure 7-94. Register 0xB1 (ANALOG page)

7	6	5	4	3	2	1	0
DITHER DIVIDER							
R/W-0	R/W-0	R/W-0	R/W-0	R/W-0	R/W-0	R/W-0	R/W-0

Table 7-103. Register 0xB1 Field Descriptions

Bit	Field	Type	Reset	Description
7-0	DITHER DIVIDER	R/W	0	This register sets the dither divider frequency. SPI write is actual -1. For example a divider of 48 is 47 (0x2F). 0x00 (default) is a divide /50

Figure 7-95. Register 0xB4 (ANALOG page)

7	6	5	4	3	2	1	0
0	0	0	0	0	0	0	SYSREF AC
R/W-0	R/W-0	R/W-0	R/W-0	R/W-0	R/W-0	R/W-0	R/W-0

Table 7-104. Register 0xB4 Field Descriptions

Bit	Field	Type	Reset	Description
7-1	0	R/W	0	Must write 0
0	SYSREF AC	R/W	0	This register enables external AC coupling of the SYSREF input with internal biasing. 0: External DC coupling with internal 100 Ω termination 1: External AC coupling with internal biasing

Figure 7-96. Register 0xCD (ANALOG page)

7	6	5	4	3	2	1	0
0	DITH AMP2			0	0	0	0
R/W-0	R/W-0	R/W-0	R/W-0	R/W-0	R/W-0	R/W-0	R/W-0

Table 7-105. Register 0xCD Field Descriptions

Bit	Field	Type	Reset	Description
7	0	R/W	0	Must write 0
6-4	DITH AMP2	R/W	0	This register sets dither amplitude fine gain. There are two recommended settings: 000: Amplitude = 0 100: Amplitude = -4 Here is a list of all the settings: 000: Amplitude = 0 001: Amplitude = 1 010: Amplitude = 2 011: Amplitude = 3 (largest) 100: Amplitude = -4 (smallest) 101: Amplitude = -3 110: Amplitude = -2 111: Amplitude = -1
3-0	0	R/W	0	Must write 0

Figure 7-97. Register 0xE6/E7 (ANALOG page)

ADDR	7	6	5	4	3	2	1	0
0xE6	TX SWING [0]	0	0	0	0	0	0	0
0xE7	0	0	0	0	0	0	TX SWING [2:1]	
	R/W-0	R/W-0	R/W-0	R/W-0	R/W-0	R/W-0	R/W-0	R/W-0

Table 7-106. Register 0xE6/E7 Field Descriptions

Bit	Field	Type	Reset	Description
7-0	0	R/W	0	Must write 0
1,0,7	TX SWING [2:0]	R/W	000	This register adjusts the output amplitude on all 8 serdes lanes. 0: 850 mVpp 1: 825 mVpp 2: 800 mVpp 3: 775 mVpp 4: 950 mVpp 5: 925 mVpp 6: 900 mVpp 7: 875 mVpp

8 Application and Implementation

Note

Information in the following applications sections is not part of the TI component specification, and TI does not warrant its accuracy or completeness. TI's customers are responsible for determining suitability of components for their purposes, as well as validating and testing their design implementation to confirm system functionality.

8.1 Application Information

The ADC32RF5x can be used in a wide range of applications including radar, frequency domain digitizer and spectrum analyzer, test and communications equipment and software-defined radios (SDRs). The Typical Applications section describe one configuration that meets the needs of a number of these applications.

8.2 Typical Applications

8.2.1 Wideband RF Sampling Receiver

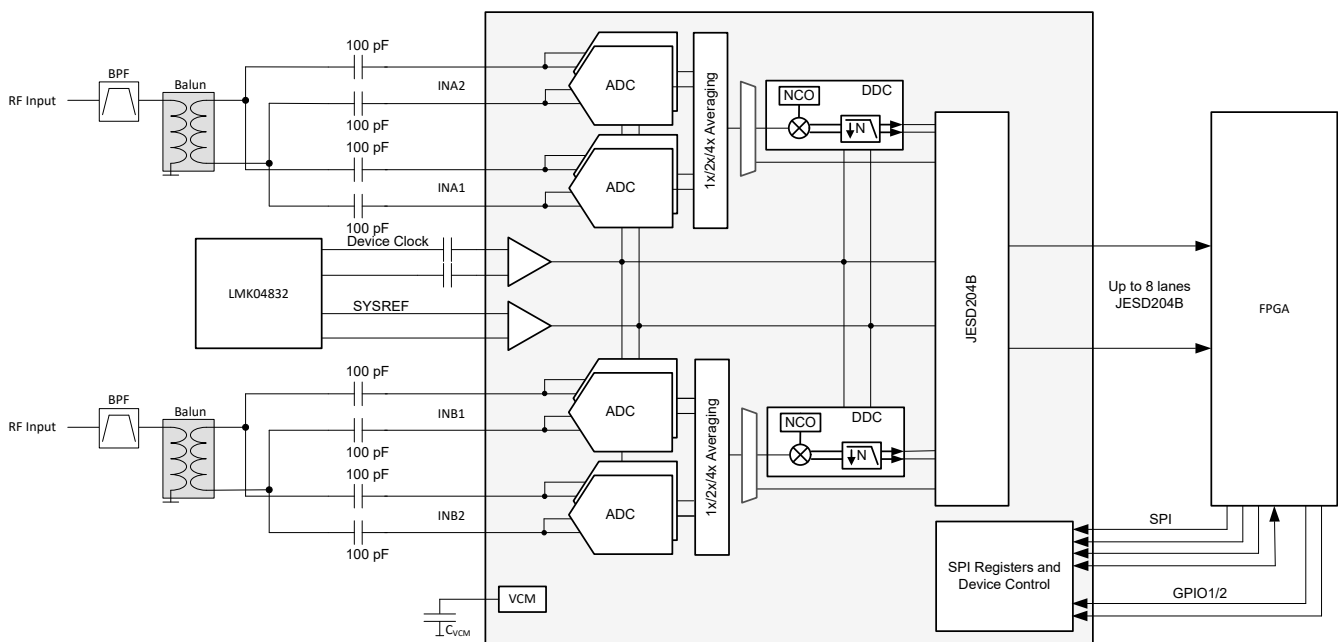

Figure 8-1. Typical Configuration for Wideband RF Sampling

8.2.1.1 Design Requirements

8.2.1.1.1 Input Signal Path

Appropriate band limiting filters should be used to reject unwanted frequencies in the receive signal path.

A 1:2 (for 100 ohm effective termination impedance) or a 1:1 (for 50 ohm effective termination impedance) balun transformer is needed to convert the single ended RF input to differential for input to the ADC. The balun outputs should be AC coupled with 100 pF capacitors. The balun should have good amplitude (< 0.5 dB) and phase balance (less than 2 deg) within the frequency range of interest. A back-to-back balun configuration often times gives better SFDR performance. [Table 8-1](#) lists a number of recommended baluns for different impedance ratios and frequency ranges.

The S-parameters of the ADC input can be used in order to design the front end matching network.

Table 8-1. Recommended Baluns

PART NUMBER	MANUFACTURER	IMPEDANCE RATIO	AMPLITUDE BALANCE (dB)	PHASE BALANCE (°)	FREQUENCY RANGE
BAL-0009SMG	Marki Microwave	1:2	0.6	5	0.5 MHz to 9 GHz
TCM2-43X+	Minicircuits	1:2	0.5	7	10 MHz to 4 GHz
TCM2-33WX+	Minicircuits	1:2	0.7	4	10 MHz to 3 GHz
TC1-1-13M+	Minicircuits	1:1	0.5	2-3	10 MHz to 3 GHz

8.2.1.1.2 Clocking

The device clock inputs must be AC-coupled to the device to provide the rated performance. The clock source must have low jitter (integrated phase noise) for the ADC to meet the stated SNR performance, especially when operating at higher input frequencies. The clock signal may need to be filtered with a band pass filter in order to remove some of the broad band clock noise.

The JESD204B data converter system (ADC and FPGA) requires additional SYSREF and device clocks. The LMK04828 or LMK04832 devices are suitable to generate these clocks. Depending on the ADC clock frequency and jitter requirements. The device may also be used as a system clock synthesizer or as a device clock and SYSREF distribution device when using multiple ADC32RF5x devices in a system.

8.2.1.2 Detailed Design Procedure

8.2.1.2.1 Sampling Clock

In order to maximize the SNR performance of the ADC a very low jitter (< 50 fs) sampling clock is required. Figure 8-2 shows the estimated SNR performance vs input frequency vs external clock jitter. The internal ADC aperture jitter also has some dependency to the clock amplitude (gets more sensitive with higher input frequency) as shown in Figure 8-3.

When using averaging and/or decimation, the SNR for a single ADC core should be estimated first before adding the SNR improvement from internal averaging and/or decimation.

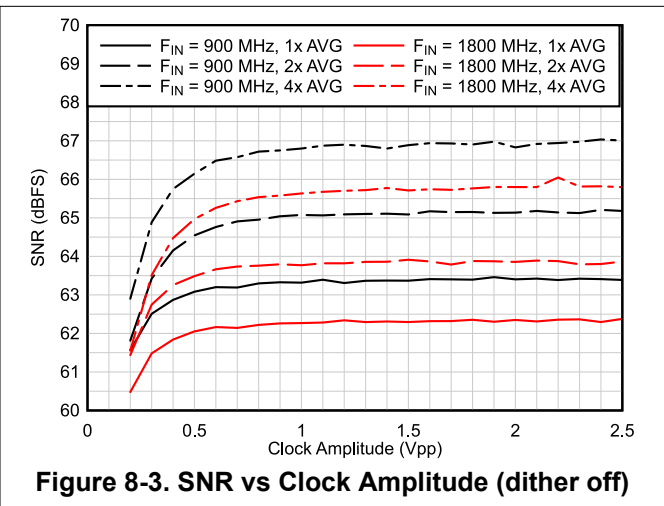
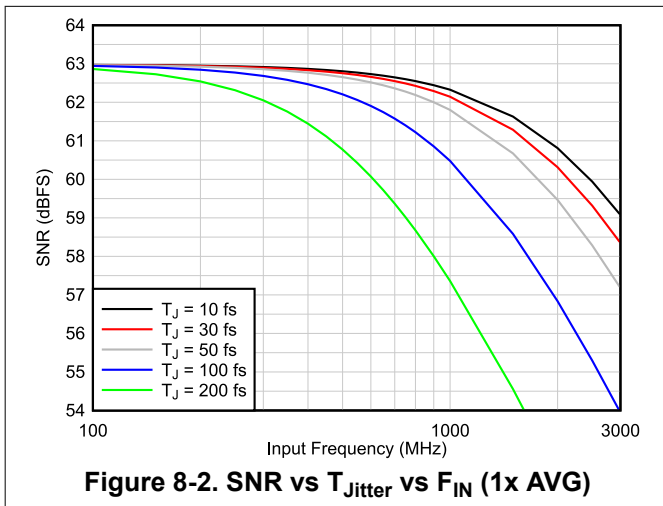

8.2.1.3 Application Curves

The following application curves demonstrate performance and results only of the ADC using a balun front end and configured to 4x internal averaging. The input frequency is 900 MHz ($F_S = 2.6$ GSPS) and input amplitudes of -6 and -20 dBFS are shown with dither enabled/disabled.

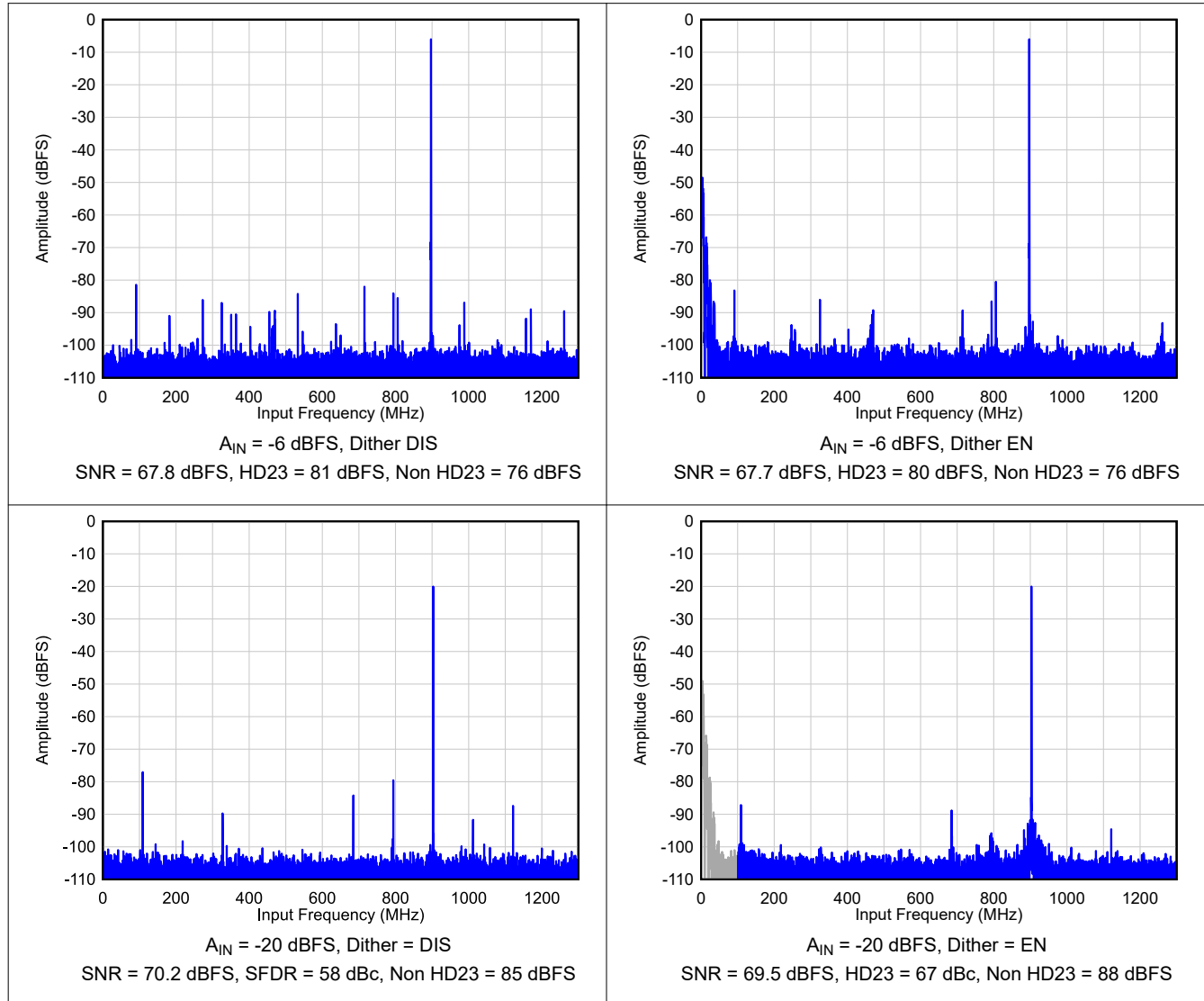

8.3 Initialization Set Up

After power-up, the internal registers must be initialized to their default values through a hardware reset by applying a low pulse on the RESET pin, as shown in Figure 8-4.

1. Apply 1.2 V DVDD digital power supply
2. Apply remaining 1.2 V power supplies (AVDD12, CLKVDD), in no specific order
3. Apply 1.8 V AVDD18 power supply
4. Apply hardware reset. After hardware reset is released, the default registers are loaded from internal fuses.
5. Begin programming the internal registers using the SPI interface.

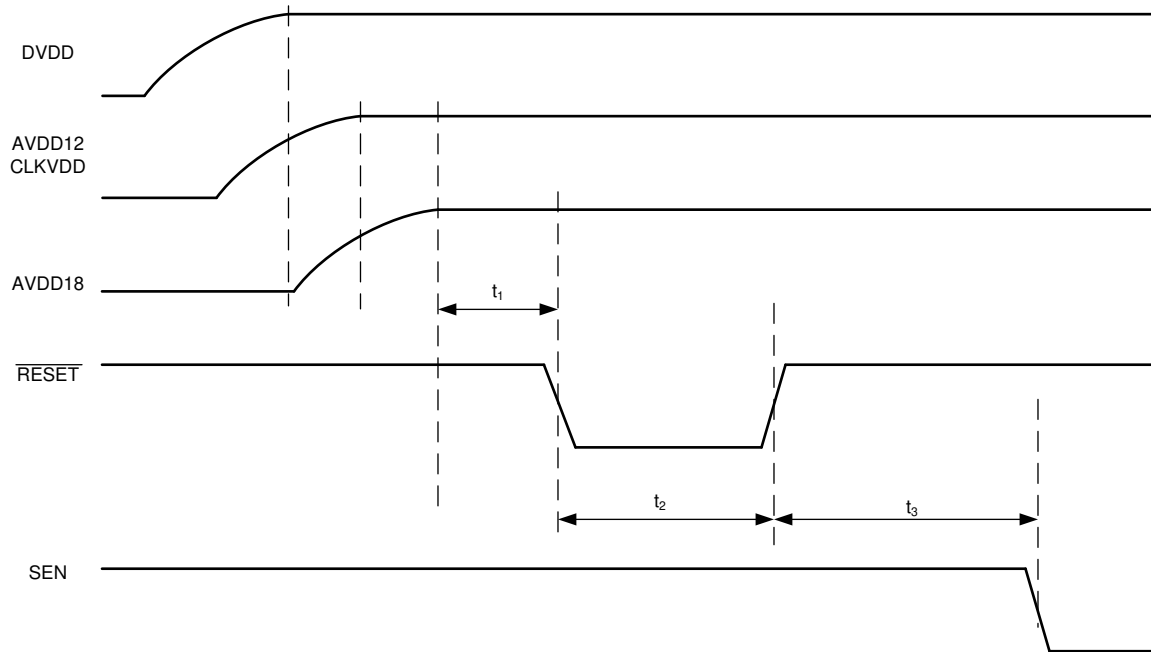

Figure 8-4. Initialization of Serial Registers After Power-Up

Table 8-2. Power-Up Timing

		MIN	TYP	MAX	UNIT
t ₁	Power-on delay: delay from power up to active high RESET pulse	1			ms
t ₂	Reset pulse width: active low RESET pulse width	100			ns
t ₃	Register write delay: delay from RESET disable to SEN active	45k			Clock cycles

8.3.1 Initial Device Configuration After Power-Up

The following section outlines the sequence of register writes for the device configuration after initial power-up.

Table 8-3. Summary of Programming Steps After Initial Power-Up

Step	Section	Description
1	RESET	Hardware and software RESET in order to reset all registers to known state
2	DEVICE CONFIG	Configures the digital operating modes like averaging, test pattern output, input termination, internal dither and decimation.
3	JESD	Configures the JESD204B interface
4	SYSREF	Enables SYSREF input and resets internal circuits based on external SYSREF signal.
5	JESD	Clears and configures some of the JESD registers
6	TRIM	Set trim settings for best analog performance
7	CALIB CONFIG	Configure the calibration settings
8	SYSREF	Issue SYSREF for trim settings to go into effect
9	RUN CALIB	Run power up calibration
10	JESD	Synchronize the JESD interface with the receiver

The following sections outlines the detailed register writes for the device configuration after initial power up. This includes all the register writes (fields in grey) which are not documented in the register summary table. The register examples are given for 2x internal averaging, DDC bypass mode (LMFS = 8224).

8.3.1.1 STEP 1: RESET

After the initial power up, both hardware and software reset are required.

Table 8-4. Register Programming Sequence for Software RESET

ADDRESS	DATA	DESCRIPTION
0x00	0x01	Software set and reset
0x00	0x00	
0x01	0x00	These two resets are staggered in order to minimize strain on external power supply.
0x09	0x20	
0x09	0x80	
0x09	0x00	Internal memory reset (set and reset)
0x08	0x01	
0x08	0x00	Select ANALOG page
0x05	0x40	
0x47	0x80	Analog reset (set and reset)
0x47	0x00	

8.3.1.2 STEP 2: Device Configuration

In this step, the operating mode and digital features (DDC, test pattern) are configured.

Table 8-5. Register Programming Sequence for Device Configuration

ADDRESS	DATA	DESCRIPTION
0x05	0x20	Select CALIBRATION page
0x34	0x03	Select 2x averaging (1x AVG: 0x01, 4x AVG: 0x07)
0x05	0x02	Select DIGITAL page
0x2C	0x01	Select DDC Bypass mode
0x2D	0x00	No decimation, step can be skipped
0x2E	0x0B	Select 2x averaging (1x: 0x09, 4x: 0x0D)
0x23C	0x07	Set register to 0x07
0x33	0x10	Set register to 0x10
0x2F	0x11	Set register to 0x11 (1x: 0x11, 4x: 0xE1)
0x30	0x11	Set register to 0x11 (1x: 0x11, 4x: 0xE1)
0x05	0x40	Select ANALOG page
0x7B/8B	0x00	Select internal input termination (0x00 = 100 ohm)
0xA8	0x00	DITHER AMP1: 3 = 0x80, 0 = 0x00
0xCD	0x00	DITHER AMP2: -4 = 0x40, 0 = 0x00
0x04	0x01	
0x20	0x04	
0x91	0x40	
0xAF	0x10	
0xB1	0x00	Sets dither divider. 0x00 = /50
0xB2	0x00	
0xAF	0x18	
0xAF	0x10	0x10 = dither ENABLED, 0x90 = dither DISABLED
0x04	0x01	
0x20	0x00	
0x04	0x00	
0x05	0x02	
0x363	0x01	
0x05	0x08	Select DDCA page, load non linearity correction (NLC) trims
0x224	0x00	
0x223	0x00	
0x21D	0x00	if FS > 2.85 GSPS 0x00, else 0x14
0x21E	0x01	if FS > 2.85 GSPS 0x00, else 0x11
0x205	0x03	
0x204	0xFF	
0x21A	0x3C	
0x31C	0x3E	
0x325	0x00	
0x325	0x01	
0x325	0x00	
0x21C	0x00	Nyquist zone 1: 0x00, other Nyquist zone 0x02
0x225	0x00	
0x225	0x01	

Table 8-5. Register Programming Sequence for Device Configuration (continued)

ADDRESS	DATA	DESCRIPTION
0x225	0x00	
0x05	0x10	Select DDCB page, load non linearity correction (NLC) trims
0x224	0x00	
0x223	0x00	
0x21D	0x00	if FS > 2.85 GSPS 0x00, else 0x14
0x21E	0x01	if FS > 2.85 GSPS 0x00, else 0x11
0x205	0x03	
0x204	0xFF	
0x21A	0x3C	
0x21C	0x00	Nyquist zone 1: 0x00, other Nyquist zone 0x02
0x31C	0x3E	
0x325	0x00	
0x325	0x01	
0x325	0x00	
0x225	0x00	
0x225	0x01	
0x225	0x00	
0x05	0x08	
0x20	0x02	OVR MUX EN
0x203	0x30	
0x303	0x30	
0x180	0x30	

8.3.1.3 STEP 3: JESD Interface Configuration (1)

In this step, the JESD204B digital interface and the parameters are configured.

Table 8-6. Register Programming Sequence for JESD204B Interface Configuration

ADDRESS	DATA	DESCRIPTION
0x05	0x02	Select DIGITAL page
0x81	0x00	Set register to 0x00
0x80	0xF0	Set register to 0xF0
0x7F	0xFF	Set register to 0xFF
0x7E	0xFF	Set register to 0xFF
0x7D	0xFF	Set register to 0xFF
0x7C	0xFF	Set register to 0xFF
0x7B	0x3B	Set register to 0x3B
0x7A	0x28	Set register to 0x28
0x79	0x51	Set register to 0x51
0x78	0x40	Set register to 0x40
0x05	0x04	Select JESD page
0x23	0x03	Set register to 0x03
0x29	0xFF	Set register to 0xFF
0x20	0x0F	Select K (0x0F: K=15)
0x21	0x01	SYSREF mode
0x22	0x01	Select LMFS configuration (LMFS = 8-2-2-4)
0x24	0x00	Select DDC CLK DIV
0x25	0x00	Select JESD TX CLK DIV
0x26	0x00	
0x27	0x02	Select CLK BAL EN for LMFS = 8-2-2-4
0x53	0x80	Output scrambler EN/DIS (SCR EN)
0x5C	0x01	M-1 in ILA (M=2)
0x5D	0x0F	K-1 in ILA (K=15)
0x6E	0x11	
0xA0	0x00	
0xA1	0x00	Select JESD PLL INPUT divider 1/2/3
0xA2	0x00	
0x9F	0x00	Select JESD PLL setting
0x2A	0x0C	
0x23	0x02	JESD INIT toggle
0x23	0x00	

8.3.1.4 STEP 4: SYSREF Synchronization

After device and JESD204B interface configuration a synchronization using external SYSREF is necessary.

Table 8-7. Device Synchronization Using External SYSREF

ADDRESS	DATA	DESCRIPTION
0x05	0x02	Select DIGITAL page
0x236	0x02	Enable internal SYSREF input and clear SYSREF pulse counter
0x236	0x03	Starts SYSREF counter

8.3.1.5 STEP 5: JESD Interface Configuration (2)

Some registers of the JESD204B interface need to be set after the first SYSREF.

Table 8-8. Register Programming Sequence for JESD204B Interface Configuration

ADDRESS	DATA	DESCRIPTION
0x05	0x04	Select JESD page
0x29	0x00	
0x84	0x00	JESD PLL factor

8.3.1.6 STEP 6: Analog Trim Settings

The following registers need to be set for best analog performance. The register write order is all writes in first 2 columns before moving to the next set of address/data in middle columns, and so on.

Table 8-9. Analog Trim Setting Registers

ADDR	DATA	ADDR	DATA	COMMENT	ADDR	DATA	COMMENT
0x05	0x40	0x3D	0x06	Only for $F_S > 2.9$ GSPS	0x56	0x03	
0xE8	0xF0	0x104	0x60		0x56	0x07	
0xE9	0x01	0x3B	0x0C	Only for $F_S < 2.9$ GSPS	0x56	0x0F	
0x4B	0x1F	0xA8	0x18	Only for 1x AVG	0x6E	0x08	
0x5B	0x01	0xA8	0x00	Only for 2x/4x AVG, $F_S < 1.1$ GSPS	0x102	0x02	
0xEA	0x00	0xA8	0x08	Only for 2x/4x AVG, $F_S = 1.1-1.8$ GSPS	0x103	0xD9	
0xEB	0x03	0xA8	0x60	Only for 2x/4x AVG, $F_S = 1.85-2.6$ GSPS	0xA7	0x00	
0x95	0x00	0xA8	0x70	Only for 2x/4x AVG, $F_S = 2.6-3.0$ GSPS	0xA6	0x08	
0xFC	0x28	0xCD	0x00		0x05	0x20	
0xE0	0x8E	0xCE	0x00		0xC9	0x09	
0xE1	0x03	0x100	See Table 8-10 for sample rate dependent trim registers		0x102	0xFE	
0x4C	0x40	0x101			0x103	0x03	
0x4E	0x01	0x104			0x104	0xD4	
0x4E	0x00	0x105			0x105	0x03	
0xA1	0x01	0x107	0x10		0x106	0xFE	
0xF8	0x00	0x05	0x20		0x107	0x03	
0x31	0x20	0x30	0xE8		0x108	0xBC	
0xFD	0x1C	0x31	0xFF		0x109	0x1A	
0xAA	0x02	0x30	0x08		0x101	0x01	
0x4D	0x80	0x31	0x80		0x159	0x63	
0xB3	0x30	0x32	0x03		0x05	0x40	
0x64	0x10	0x05	0x02		0x31	0x00	
0x62	0x12	0x243	0x02		0x4D	0x00	
0xFE	0x80	0x05	0x20		0x62	0x10	
0xFC	0x28	0x36	0x04		0x56	0x0E	
0xFF	0x14	0x1F8	0x01		0x56	0x0C	
0x106	0x00	0x1FC	0x0A		0x56	0x08	
0x107	0x00	0x1F0	0x20		0x56	0x00	
		0x1F1	0x0C		0x6E	0x00	
		0x05	0x40		0xF8	0x06	

Table 8-9. Analog Trim Setting Registers (continued)

ADDR	DATA	ADDR	DATA	COMMENT	ADDR	DATA	COMMENT
		0x39	0x40		0x102	0x42	Only for $F_S > 2.9$ GSPS
		0x56	0x01				

Table 8-10. Sample rate dependent trim registers

F_S (GSPS)	0x100	0x101	0x104	0x105
0.6-0.7	0x48	0x00	0x01	0x01
0.7-0.9	0xC8	0x01	0x81	0x00
0.9-1.1	0x48	0x01	0x81	0x00
1.1-1.3	0xC8	0x00	0x81	0x00
1.3-1.5	0x48	0x00	0x81	0x00
1.5-1.7	0xC8	0x01	0x01	0x00
1.7-1.9	0x48	0x01	0x01	0x00
1.9-2.1	0xC8	0x00	0x01	0x00
2.1-2.3	0x48	0x00	0x01	0x00
2.3-2.5	0xC8	0x01	0x81	0x03
2.5-2.7	0x48	0x01	0x81	0x03
2.7-2.9	0xC8	0x00	0x81	0x0
2.9-3.0	0x48	0x00	0xE1	0x03

8.3.1.7 STEP 7: Calibration Configuration

The following registers configure the internal foreground calibration. The register write order is all writes in first 2 columns before moving to the next set of address/data in middle columns, and so on.

Table 8-11. Calibration Register Settings

ADDRESS	DATA	ADDRESS	DATA	ADDRESS	DATA
0x05	0x40	0xFC	0x13	0x47	0xC7
0x68	0xC0	0xFD	0x08	0x46	0x13
0x69	0xFF	0x36	0x04	0xFC	0x13
0x05	0x20	0x36	0x05	0xFD	0x00
0x46	0x03	0x36	0x04	0x36	0x04
0x47	0xC2	0xFC	0x13	0x36	0x05
0x46	0x13	0xFD	0x0A	0x36	0x04
0x1AE	0x00	0x36	0x04	0xFC	0x13
0x1E6	0x1C	0x36	0x05	0xFD	0x02
0x1AE	0x00	0x36	0x04	0x36	0x04
0x1E6	0x1C	0xFC	0x13	0x36	0x05
0x1E9	0x08	0xFD	0x0C	0x36	0x04
0x1E9	0xA8	0x36	0x04	0xFC	0x13
0x1E8	0x02	0x36	0x05	0xFD	0x04
0x1E8	0x06	0x36	0x04	0x36	0x04
0x1E8	0x04	0xFC	0x13	0x36	0x05
0x1E8	0x00	0xFD	0x0E	0x36	0x04
0x1E9	0xA0	0x36	0x04	0xFC	0x13
0x1F0	0x28	0x36	0x05	0xFD	0x06
0x1F1	0x0C	0x36	0x04	0x36	0x04
0x1F0	0x2A	0xFC	0x03	0x36	0x05
0x1F0	0x2E	0x36	0x04	0x36	0x04
0x1F0	0x2C	0x46	0x03	0xFC	0x13
0x1F0	0x28	0x47	0xC0	0xFD	0x08
0x1F0	0x08	0x46	0x13	0x36	0x04
0x1F0	0x18	0x46	0x03	0x36	0x05
0x1F0	0x38	0x47	0xC7	0x36	0x04
0x1F1	0x0C	0x46	0x13	0xFC	0x13
0x1F0	0x3A	0x1AE	0x00	0xFD	0x0A
0x1F0	0x3E	0x1E6	0x1C	0x36	0x04
0x1F0	0x3C	0x1AE	0x00	0x36	0x05
0x1F0	0x38	0x1E6	0x1C	0x36	0x04
0x1F0	0x18	0x1E9	0xA8	0xFC	0x13
0x1F0	0x10	0x1E8	0x02	0xFD	0x0C
0x1AE	0x00	0x1E8	0x06	0x36	0x04
0x1E6	0x1C	0x1E8	0x04	0x36	0x05
0x1AE	0x00	0x1E8	0x00	0x36	0x04
0x1E6	0x1C	0x1E9	0xA0	0xFC	0x13
0x47	0xC0	0x1F0	0x18	0xFD	0x0E
0x46	0x03	0x1F0	0x08	0x36	0x04
0x47	0xC2	0x1F0	0x28	0x36	0x05
0x46	0x13	0x1F1	0x0C	0x36	0x04

Table 8-11. Calibration Register Settings (continued)

ADDRESS	DATA	ADDRESS	DATA	ADDRESS	DATA
0xFC	0x13	0x1F0	0x2A	0xFC	0x03
0xFD	0x00	0x1F0	0x2E	0x36	0x04
0x36	0x04	0x1F0	0x2C	0x46	0x03
0x36	0x05	0x1F0	0x28	0x47	0xC0
0x36	0x04	0x1F0	0x08	0x46	0x13
0xFC	0x13	0x1F0	0x18	0x05	0x40
0xFD	0x02	0x1F0	0x38	0x68	0x40
0x36	0x04	0x1F1	0x0C	0x69	0xFD
0x36	0x05	0x1F0	0x3A	0x69	0xF5
0x36	0x04	0x1F0	0x3E	0x69	0xD5
0xFC	0x13	0x1F0	0x3C	0x69	0x55
0xFD	0x04	0x1F0	0x38	0x68	0x00
0x36	0x04	0x1F0	0x18	0x69	0x54
0x36	0x05	0x1F0	0x10	0x69	0x50
0x36	0x04	0x1AE	0x00	0x69	0x40
0xFC	0x13	0x1E6	0x1C	0x69	0x00
0xFD	0x06	0x1AE	0x00	0x93	0x0E
0x36	0x04	0x1E6	0x1C	0x94	0x70
0x36	0x05	0x47	0xC0	0x94	0x77
0x36	0x04	0x46	0x03		

8.3.1.8 STEP 8: SYSREF Synchronization

After setting the analog trim registers, a synchronization using external SYSREF is necessary.

Table 8-12. Device Synchronization Using External SYSREF

ADDRESS	DATA	DESCRIPTION
0x05	0x02	Select DIGITAL page
0x236	0x02	Enable internal SYSREF input and clear SYSREF pulse counter
0x236	0x03	Starts SYSREF counter

8.3.1.9 STEP 9: Run Power up Calibration

The following registers start the power up foreground calibration. The register write order is all writes in first 2 columns before moving to the next set of address and/or data in middle columns, and so on.

Table 8-13. Calibration Register Settings

ADDRESS	DATA	ADDRESS	DATA	ADDRESS	DATA
0x05	0x20	0x93	0x20	0x58	0x30
0xE7	0x01	0x20	0x00	0x58	0x20
0x174	0x02	0x05	0x00	0x58	0x00
0x178	0x00	0x04	0x01	0x89	0x20
0x17C	0x22	0x20	0x1F	0x95	0x00
0x3C	0x00	0x93	0x20	0x96	0x00
0xFC	0x03	0x04	0x01	0x97	0x10
0xFD	0x00	0x20	0x00	0x9C	0x00
0x154	0x1C	0x04	0x00	0x57	0x1E
0x155	0x03	0x05	0x20	0x46	0x02
0xFC	0x03	0xC0	0x7C	0x45	0x8A

Table 8-13. Calibration Register Settings (continued)

ADDRESS	DATA	ADDRESS	DATA	ADDRESS	DATA
0xEE	0x26	0xBC	0x3C	0x45	0x0A
0xEF	0x02	0xC9	0x01	Delay 3 seconds	
0x18C	0x88	0xC9	0x00	0x89	0x00
0xAE	0xC8	0xC9	0x06	0x95	0x00
0xAF	0x00	0x38	0x01	0x96	0x00
0xB0	0x4C	0x110	0x10	0x97	0x00
0xB1	0x3F	0x111	0x42	0x9C	0x00
0x4F	0x46	0x112	0xA6	0x57	0x1A
0x50	0x2C	0x112	0xD6	0x57	0x3A
0x51	0x05	0x113	0xBB	0x57	0x7A
0x154	0x7C	0x113	0xDB	0x57	0xFA
0x158	0x7C	0x114	0xF4	0x58	0x01
0x159	0x6F	0x114	0x64	0x58	0x03
0x15C	0x7C	0x115	0x0E	0x58	0x07
0x15D	0x3F	0x115	0xFE	0x58	0x0F
0x160	0x7C	0x116	0x0D	0x58	0x1F
0x161	0x3F	0x116	0xDD	0x58	0x3F
0x164	0x7C	0x117	0x0D	0x45	0x8A
0x165	0x4F	0x117	0xDD	0x45	0x0A
0x16C	0x7C	0x46	0x03	Delay 3 seconds	
0x1B0	0x1C	0x3D	0x00	0x47	0xC0
0x1B1	0x5F	0x45	0x0A	0x46	0x03
0x1D8	0x1C	0x46	0x02	0x47	0xC0
0x1D9	0xAF	0x64	0x4A	0x05	0x80
0xB2	0x1F	0x65	0x05	0x20	0x1F
0xB5	0x7F	0x68	0x28	0x9D	0x05
0x165	0xFF	0x69	0x5E	0x9E	0x08
0x38	0x01	0x6A	0x3D	0x8B	0x40
0xA4	0x30	0x6B	0x8F	0x20	0x00
0xC5	0x7F	0x6C	0x44	0x05	0x00
0xA8	0x00	0x57	0xDA	0x04	0x01
0xA2	0x63	0x57	0x9A	0x20	0x1F
0xA3	0x00	0x57	0x1A	0x9D	0x05
0xAD	0x02	0x58	0x3E	0x9E	0x08
0x05	0x80	0x58	0x3C	0x8B	0x40
0x20	0x1F	0x58	0x38		

8.3.1.10 STEP 10: JESD Interface Synchronization

The JESD interface can be synchronized using SPI writes or the GPIO1 pin.

Table 8-14. JESD Interface Synchronization Using SPI Writes

ADDRESS	DATA	DESCRIPTION
0x05	0x04	Select JESD page
0x21	0x41	Configure ADC to control SYNC using SPI writes
0x21	0x61	Configure JESD interface to send K28.5 characters for receiver synchronization

Table 8-14. JESD Interface Synchronization Using SPI Writes (continued)

ADDRESS	DATA	DESCRIPTION
0x21	0x41	Configure JESD interface to send normal ADC data

8.4 Power Supply Recommendations

The ADC32RF5x requires four different power-supplies. The AVDD18, AVDD12 and CLKVDD rail provides power for the internal analog and clocking circuits of the ADC. The DVDD rail powers the digital logic (including averaging and decimation filter) and the JESD204B digital interface.

Power sequencing is required as shown in [Initialization Set Up](#). The AVDD18, AVDD12 and especially the CLKVDD power supply must be low noise in order to achieve data sheet performance. For applications operating near DC, the 1/f noise contribution of the power supply needs to be considered as well.

Power supply decoupling capacitors (0.1 μF) as close to the pins as possible on the top layer are recommended.

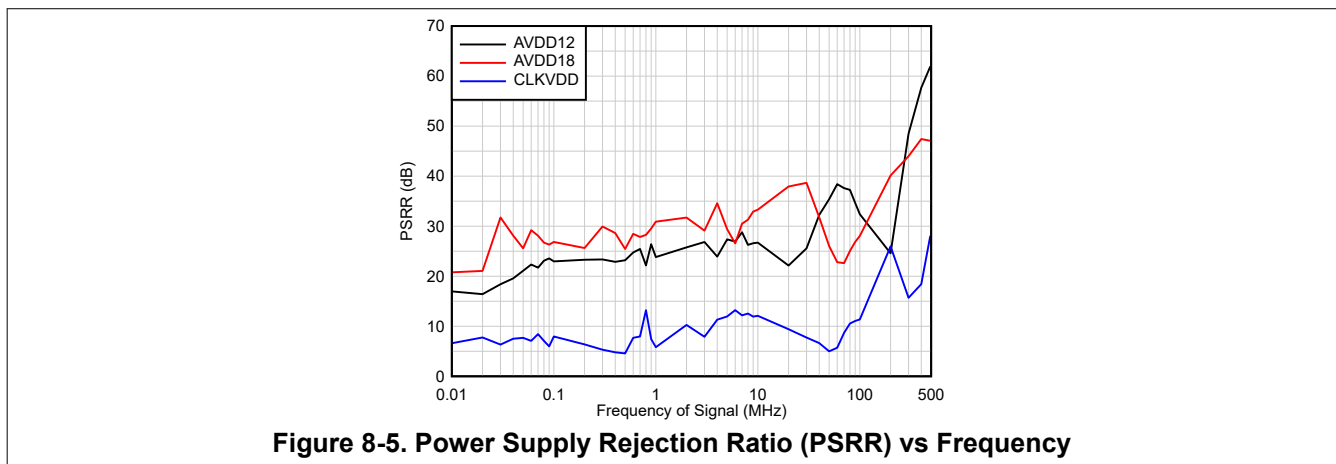

The recommended power supply architecture for a low noise design is to first use a high-efficiency step down switching regular, followed by a second stage of regulation using a low noise LDO for each power rail as shown in [Figure 8-6](#). This provides additional switching noise reduction and improved voltage accuracy.

TI WEBENCH® Power Designer can be used to select and design the individual power-supply elements. Recommended switching regulators for the first stage include the LMS3635, and similar devices. Recommended low dropout (LDO) linear regulators include the TPS7A8400, and similar devices.

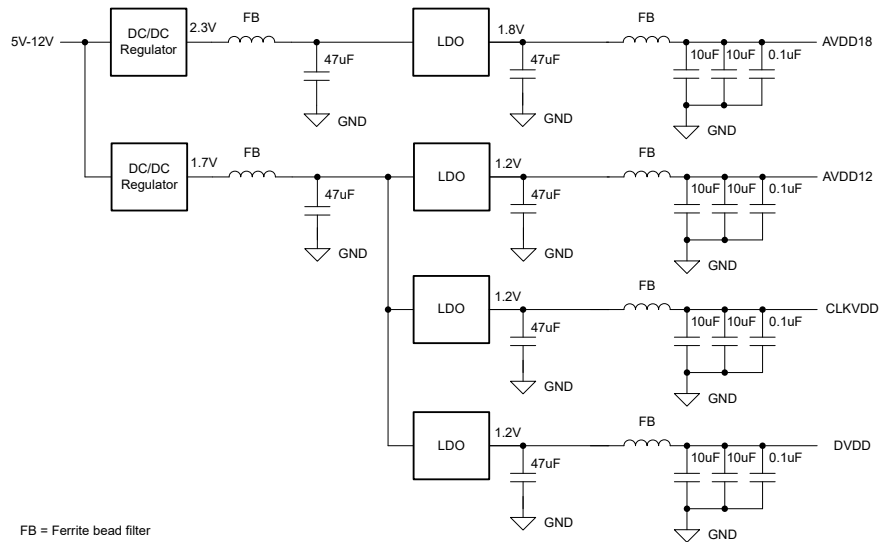

Figure 8-6. Power Supply Design Example

AVDD12 or CLKVDD should not be shared with the DVDD in order to prevent digital switching noise from coupling into the analog domain.

8.5 Layout

8.5.1 Layout Guidelines

There are several critical signals which require specific care during board design:

1. Analog input and clock signals
 - Traces should be as short as possible and vias should be avoided where possible to minimize impedance discontinuities.
 - Traces should be routed using loosely coupled 100-Ω differential traces.
 - Differential trace lengths should be matched as close as possible to minimize phase imbalance and HD2 degradation.
2. Digital JESD204B output interface
 - Traces should be routed using tightly coupled 100-Ω differential traces.
3. Power and ground connections
 - Provide low resistance connection paths to all power and ground pins.
 - Use power and ground planes instead of traces.
 - Avoid narrow, isolated paths which increase the connection resistance.
 - Use a signal/ground/power circuit board stackup to maximize coupling between the ground and power plane.

8.5.2 Layout Example

The following screen shot shows the top layer of the ADC32RF5x EVM.

- The input signal traces are routed as differential signals on the top layer avoiding vias. Care is taken to maintain symmetry between positive and negative input with matched trace length in order to minimize phase imbalance.
- [Figure 8-7](#) shows the layout example for 1x and 2x averaging configuration
- [Figure 8-8](#) shows the layout example for 4x averaging configuration
- JESD204B output interface lanes are routed differential and length matched
- Bypass caps are close to the power pins on the top layer avoiding vias.

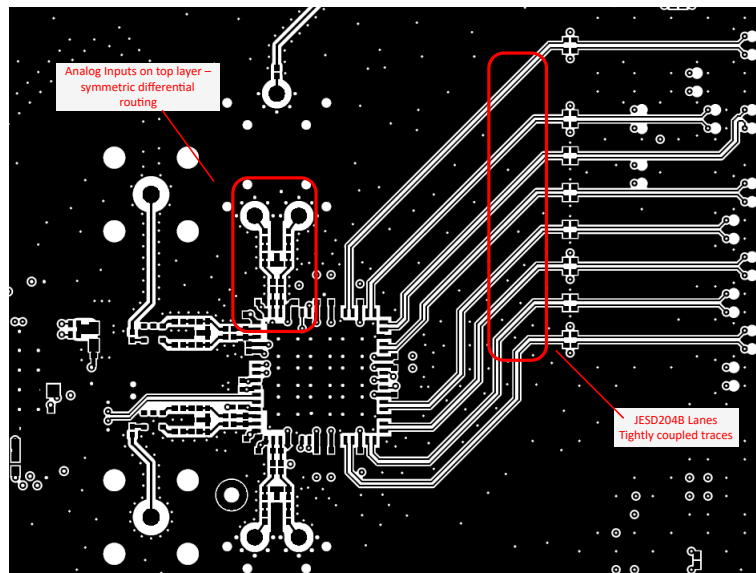

Figure 8-7. Layout example: top layer of ADC32RF5x EVM

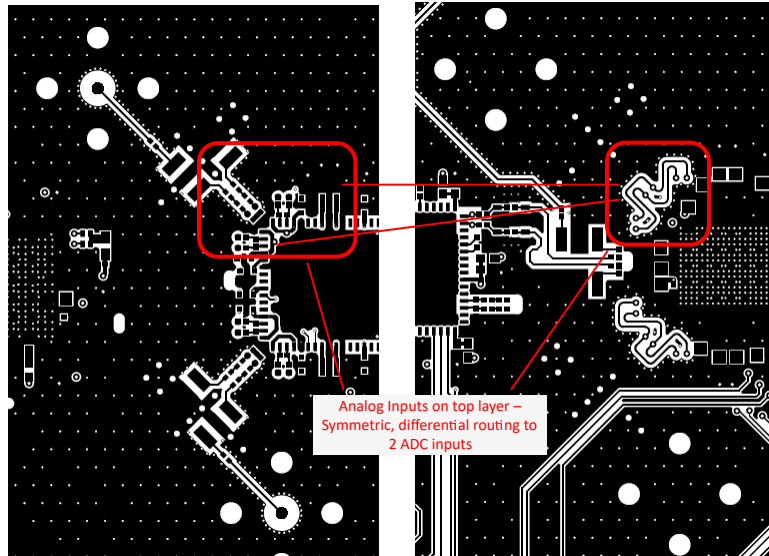

Figure 8-8. Layout example for 4x AVG: ADC32RF5x EVM

9 Device and Documentation Support

9.1 Receiving Notification of Documentation Updates

To receive notification of documentation updates, navigate to the device product folder on ti.com. Click on *Subscribe to updates* to register and receive a weekly digest of any product information that has changed. For change details, review the revision history included in any revised document.

9.2 Support Resources

[TI E2E™ support forums](#) are an engineer's go-to source for fast, verified answers and design help — straight from the experts. Search existing answers or ask your own question to get the quick design help you need.

Linked content is provided "AS IS" by the respective contributors. They do not constitute TI specifications and do not necessarily reflect TI's views; see TI's [Terms of Use](#).

9.3 Trademarks

TI E2E™ is a trademark of Texas Instruments.
All trademarks are the property of their respective owners.

9.4 Electrostatic Discharge Caution



This integrated circuit can be damaged by ESD. Texas Instruments recommends that all integrated circuits be handled with appropriate precautions. Failure to observe proper handling and installation procedures can cause damage.

ESD damage can range from subtle performance degradation to complete device failure. Precision integrated circuits may be more susceptible to damage because very small parametric changes could cause the device not to meet its published specifications.

9.5 Glossary

[TI Glossary](#) This glossary lists and explains terms, acronyms, and definitions.

10 Mechanical, Packaging, and Orderable Information

The following pages include mechanical, packaging, and orderable information. This information is the most current data available for the designated devices. This data is subject to change without notice and revision of this document. For browser-based versions of this data sheet, refer to the left-hand navigation.

PACKAGING INFORMATION

Orderable Device	Status (1)	Package Type	Package Drawing	Pins	Package Qty	Eco Plan (2)	Lead finish/ Ball material (6)	MSL Peak Temp (3)	Op Temp (°C)	Device Marking (4/5)	Samples
ADC32RF55IRTD	ACTIVE	VQFN	RTD	64	168	RoHS & Green	NIPDAU	Level-3-260C-168 HR	-40 to 85	AZ32RF55	Samples
ADC32RF55IRTDT	ACTIVE	VQFN	RTD	64	250	RoHS & Green	NIPDAU	Level-3-260C-168 HR	-40 to 85	AZ32RF55	Samples
PADC32RF54RTD	ACTIVE	VQFN	RTD	64	250	TBD	Call TI	Call TI	-40 to 85		Samples

(1) The marketing status values are defined as follows:

ACTIVE: Product device recommended for new designs.

LIFEBUY: TI has announced that the device will be discontinued, and a lifetime-buy period is in effect.

NRND: Not recommended for new designs. Device is in production to support existing customers, but TI does not recommend using this part in a new design.

PREVIEW: Device has been announced but is not in production. Samples may or may not be available.

OBSOLETE: TI has discontinued the production of the device.

(2) **RoHS:** TI defines "RoHS" to mean semiconductor products that are compliant with the current EU RoHS requirements for all 10 RoHS substances, including the requirement that RoHS substance do not exceed 0.1% by weight in homogeneous materials. Where designed to be soldered at high temperatures, "RoHS" products are suitable for use in specified lead-free processes. TI may reference these types of products as "Pb-Free".

RoHS Exempt: TI defines "RoHS Exempt" to mean products that contain lead but are compliant with EU RoHS pursuant to a specific EU RoHS exemption.

Green: TI defines "Green" to mean the content of Chlorine (Cl) and Bromine (Br) based flame retardants meet JS709B low halogen requirements of <=1000ppm threshold. Antimony trioxide based flame retardants must also meet the <=1000ppm threshold requirement.

(3) MSL, Peak Temp. - The Moisture Sensitivity Level rating according to the JEDEC industry standard classifications, and peak solder temperature.

(4) There may be additional marking, which relates to the logo, the lot trace code information, or the environmental category on the device.

(5) Multiple Device Markings will be inside parentheses. Only one Device Marking contained in parentheses and separated by a "~" will appear on a device. If a line is indented then it is a continuation of the previous line and the two combined represent the entire Device Marking for that device.

(6) Lead finish/Ball material - Orderable Devices may have multiple material finish options. Finish options are separated by a vertical ruled line. Lead finish/Ball material values may wrap to two lines if the finish value exceeds the maximum column width.

Important Information and Disclaimer:The information provided on this page represents TI's knowledge and belief as of the date that it is provided. TI bases its knowledge and belief on information provided by third parties, and makes no representation or warranty as to the accuracy of such information. Efforts are underway to better integrate information from third parties. TI has taken and continues to take reasonable steps to provide representative and accurate information but may not have conducted destructive testing or chemical analysis on incoming materials and chemicals. TI and TI suppliers consider certain information to be proprietary, and thus CAS numbers and other limited information may not be available for release.

In no event shall TI's liability arising out of such information exceed the total purchase price of the TI part(s) at issue in this document sold by TI to Customer on an annual basis.

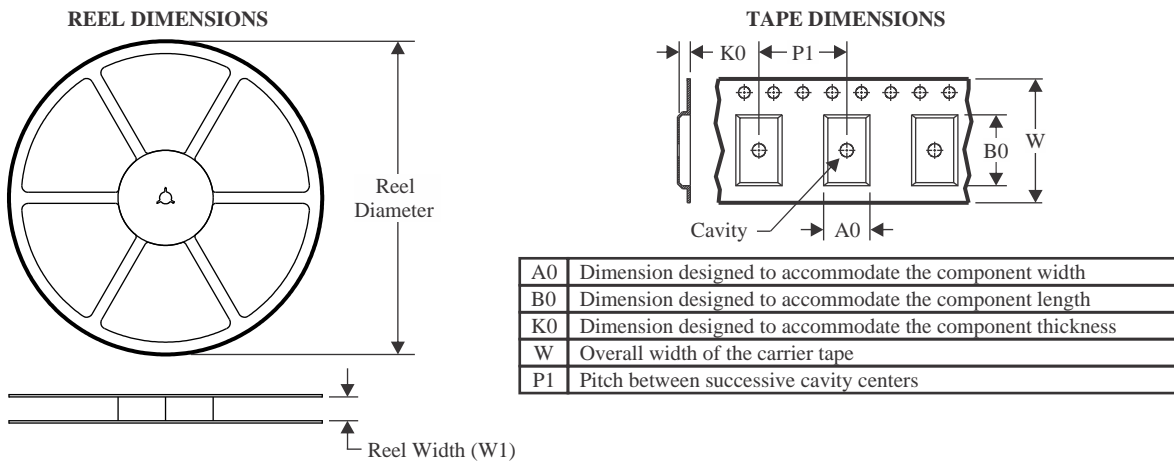
TAPE AND REEL INFORMATION

QUADRANT ASSIGNMENTS FOR PIN 1 ORIENTATION IN TAPE

*All dimensions are nominal

Device	Package Type	Package Drawing	Pins	SPQ	Reel Diameter (mm)	Reel Width W1 (mm)	A0 (mm)	B0 (mm)	K0 (mm)	P1 (mm)	W (mm)	Pin1 Quadrant
ADC32RF55IRTD	VQFN	RTD	64	250	180.0	16.4	9.3	9.3	1.5	12.0	16.0	Q2

TAPE AND REEL BOX DIMENSIONS

*All dimensions are nominal

Device	Package Type	Package Drawing	Pins	SPQ	Length (mm)	Width (mm)	Height (mm)
ADC32RF55IRTD	VQFN	RTD	64	250	213.0	191.0	55.0

GENERIC PACKAGE VIEW

RTD 64

VQFN - 0.9 mm max height

PLASTIC QUAD FLATPACK - NO LEAD

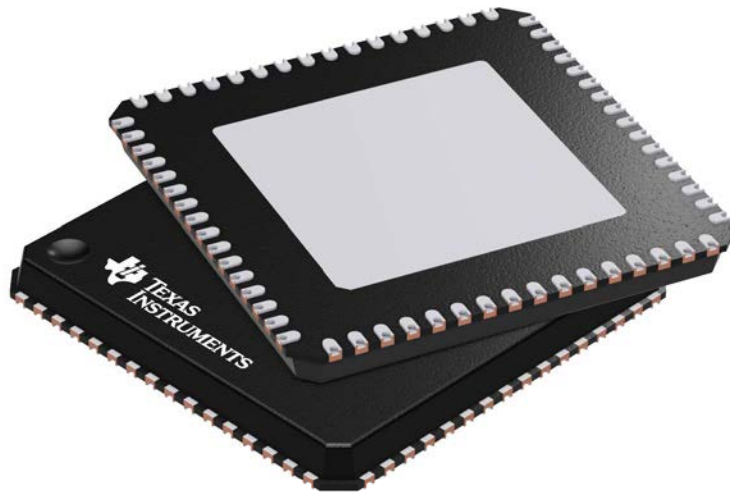

Images above are just a representation of the package family, actual package may vary.
Refer to the product data sheet for package details.

4205146/D

RTD0064N

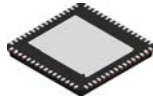

PACKAGE OUTLINE

VQFN - 0.9 mm max height

PLASTIC QUAD FLATPACK - NO LEAD

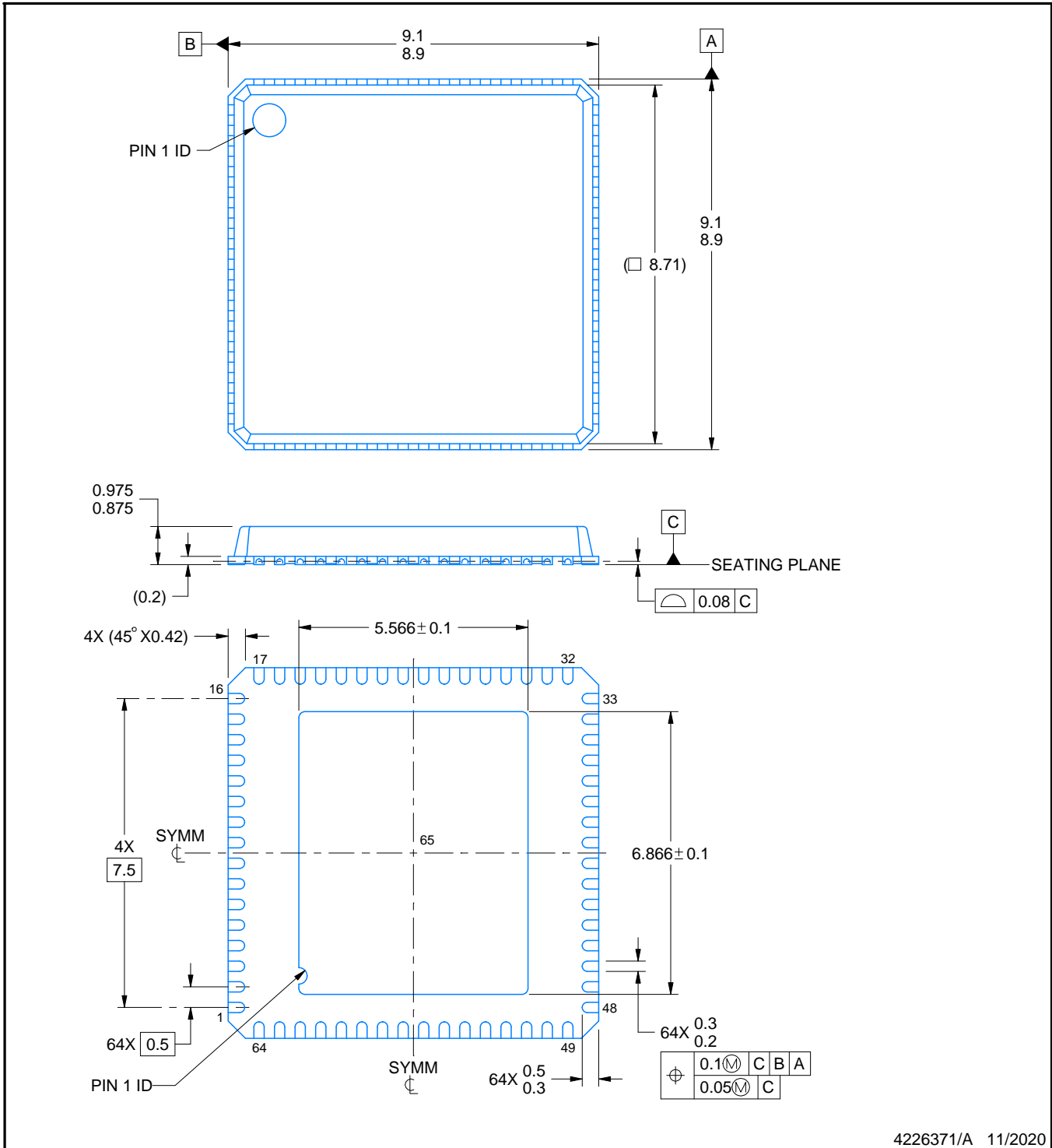

4226371/A 11/2020

NOTES:

1. All linear dimensions are in millimeters. Any dimensions in parenthesis are for reference only. Dimensioning and tolerancing per ASME Y14.5M.
2. This drawing is subject to change without notice.
3. The package thermal pad must be soldered to the printed circuit board for thermal and mechanical performance.

EXAMPLE BOARD LAYOUT

RTD0064N

VQFN - 0.9 mm max height

PLASTIC QUAD FLATPACK - NO LEAD

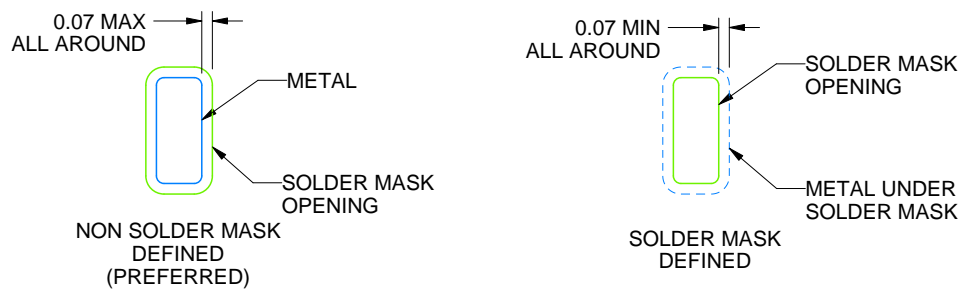
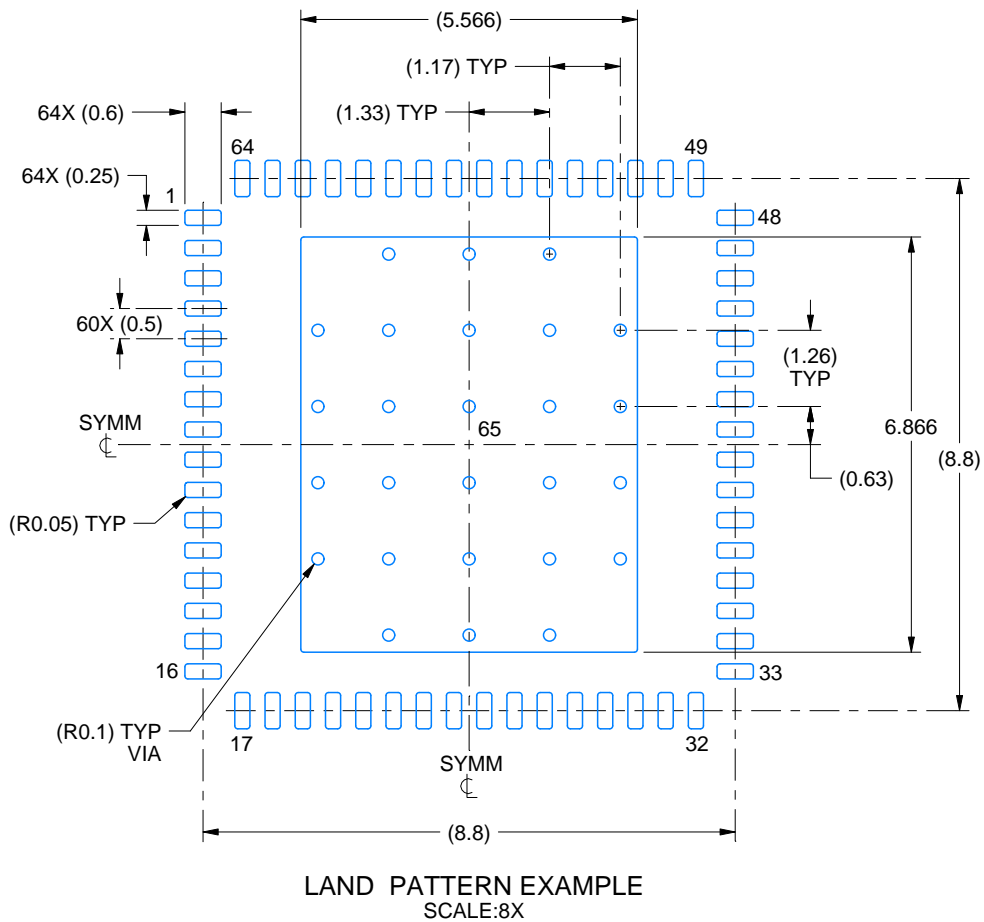

4226371/A 11/2020

NOTES: (continued)

4. This package is designed to be soldered to a thermal pad on the board. For more information, see Texas Instruments literature number SLUA271 (www.ti.com/lit/sluea271).
5. Vias are optional depending on application, refer to device data sheet. If any vias are implemented, refer to their locations shown on this view. It is recommended that vias under paste be filled, plugged or tented.

EXAMPLE STENCIL DESIGN

RTD0064N

VQFN - 0.9 mm max height

PLASTIC QUAD FLATPACK - NO LEAD

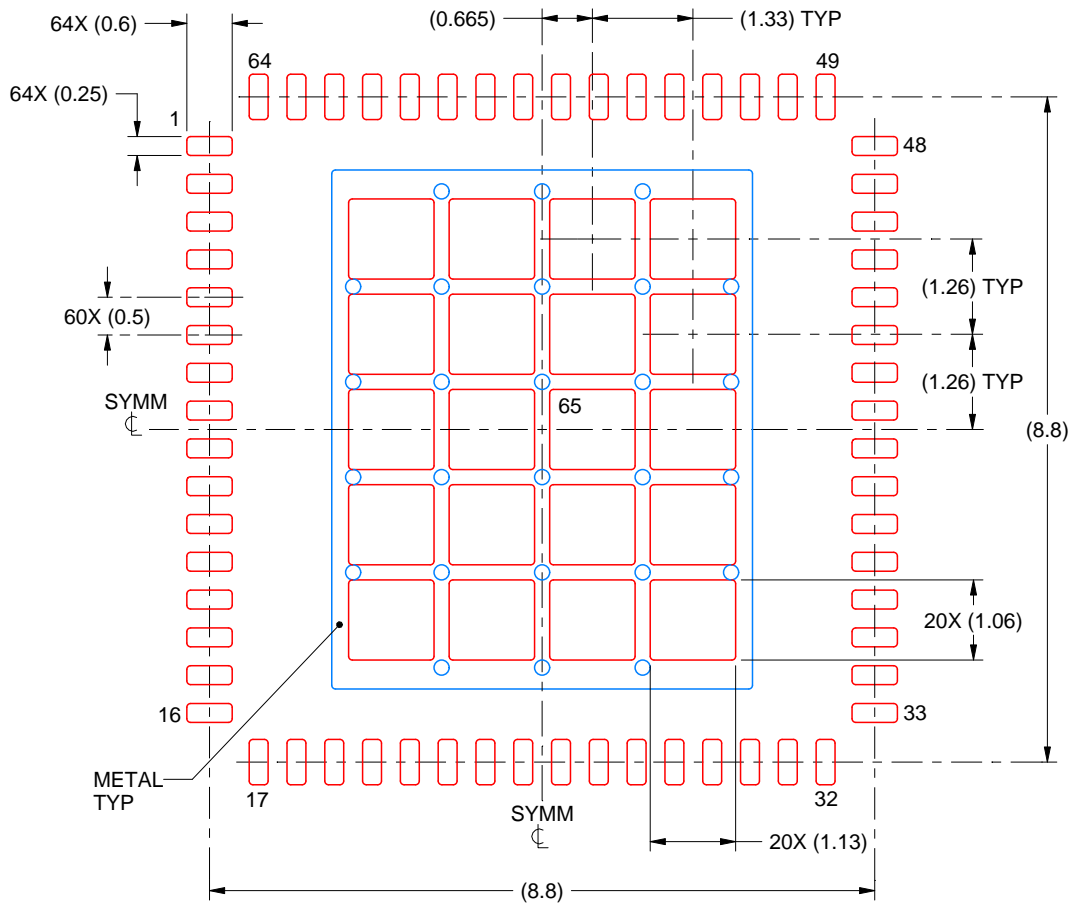

SOLDER PASTE EXAMPLE
 BASED ON 0.125 mm THICK STENCIL

EXPOSED PAD 65:
 63% PRINTED SOLDER COVERAGE BY AREA UNDER PACKAGE
 SCALE:10X

4226371/A 11/2020

NOTES: (continued)

6. Laser cutting apertures with trapezoidal walls and rounded corners may offer better paste release. IPC-7525 may have alternate design recommendations.

IMPORTANT NOTICE AND DISCLAIMER

TI PROVIDES TECHNICAL AND RELIABILITY DATA (INCLUDING DATA SHEETS), DESIGN RESOURCES (INCLUDING REFERENCE DESIGNS), APPLICATION OR OTHER DESIGN ADVICE, WEB TOOLS, SAFETY INFORMATION, AND OTHER RESOURCES "AS IS" AND WITH ALL FAULTS, AND DISCLAIMS ALL WARRANTIES, EXPRESS AND IMPLIED, INCLUDING WITHOUT LIMITATION ANY IMPLIED WARRANTIES OF MERCHANTABILITY, FITNESS FOR A PARTICULAR PURPOSE OR NON-INFRINGEMENT OF THIRD PARTY INTELLECTUAL PROPERTY RIGHTS.

These resources are intended for skilled developers designing with TI products. You are solely responsible for (1) selecting the appropriate TI products for your application, (2) designing, validating and testing your application, and (3) ensuring your application meets applicable standards, and any other safety, security, regulatory or other requirements.

These resources are subject to change without notice. TI grants you permission to use these resources only for development of an application that uses the TI products described in the resource. Other reproduction and display of these resources is prohibited. No license is granted to any other TI intellectual property right or to any third party intellectual property right. TI disclaims responsibility for, and you will fully indemnify TI and its representatives against, any claims, damages, costs, losses, and liabilities arising out of your use of these resources.

TI's products are provided subject to [TI's Terms of Sale](#) or other applicable terms available either on ti.com or provided in conjunction with such TI products. TI's provision of these resources does not expand or otherwise alter TI's applicable warranties or warranty disclaimers for TI products.

TI objects to and rejects any additional or different terms you may have proposed.

Mailing Address: Texas Instruments, Post Office Box 655303, Dallas, Texas 75265
Copyright © 2022, Texas Instruments Incorporated