



Main

Range of Product	Modicon TM5
Product or Component Type	Analog input module
Analogue input number	2
Analogue input type	Pt 100/Pt 1000 temperature probe - 200...850 °C
Analogue input resolution	16 bits

Complementary

Range Compatibility	Modicon M258 Modicon LMC058
Product Compatibility	Logic controller Motion controller
Measurement resolution	0.1 °C
Color	White
Measurement error	< 0.037 % of full scale - 200...850 °C Pt 100/Pt 1000 25 °C
Temperature coefficient	0.004 %FS/°C temperature probe
Non-linearity	0.00015 %FS temperature probe
Type of Cable	Shielded cable
Isolation	500 Vrms AC insulation between channel and bus No insulation between channels
Supply	Internal
[Us] rated supply voltage	24 V DC -15...20 %
Common mode rejection	> 95 dB
Local signalling	1 LED green power supply 1 LED red power supply 2 LEDs green input status
Current consumption	2 mA 5 V DC bus 46 mA 24 V DC input/output
Maximum power dissipation in W	1.11 W
Marking	CE
Net Weight	0.06 lb(US) (0.025 kg)

Environment

Standards	UL 508 CSA C22.2 No 142 IEC 61131-2 CSA C22.2 No 213
Product Certifications	CULus CSA GOST-R C-tick
Ambient air temperature for operation	32...131 °F (0...55 °C) without derating horizontal installation) 32...140 °F (0...60 °C) with derating factor horizontal installation) 32...122 °F (0...50 °C) vertical installation)
Ambient Air Temperature for Storage	-13...158 °F (-25...70 °C)
Relative humidity	5...95 % without condensation

IP degree of protection	IP20IEC 61131-2
Pollution degree	2 IEC 60664
Operating altitude	0...6561.68 ft (0...2000 m)
Storage altitude	0.00...9842.52 ft (0...3000 m)
Vibration resistance	1 gn 8.4...150 Hz DIN rail 3.5 mm 5...8.4 Hz DIN rail
Shock resistance	15 gn 11 ms
Resistance to electrostatic discharge	4 KV on contact EN/IEC 61000-4-2 8 kV in air EN/IEC 61000-4-2
Resistance to electromagnetic fields	0.91 V/M (1 V/m) 2...2.7 GHz EN/IEC 61000-4-3 9.14 V/m (10 V/m) 80...2000 MHz EN/IEC 61000-4-3
Resistance to fast transients	1 KV EN/IEC 61000-4-4 I/O) 1 KV EN/IEC 61000-4-4 shielded cable) 2 kV EN/IEC 61000-4-4 power lines)
Surge withstand	0.5 KV differential mode EN/IEC 61000-4-5 1 kV common mode EN/IEC 61000-4-5
Electromagnetic compatibility	EN/IEC 61000-4-6
Disturbance radiated/conducted	CISPR 11

Ordering and shipping details

Category	22532 - M258 PLC
Discount Schedule	PC12
GTIN	3595864074757
Nbr. of units in pkg.	1
Package weight(Lbs)	1.48 oz (42 g)
Returnability	No
Country of origin	AT

Packing Units

Unit Type of Package 1	PCE
Package 1 Height	0.79 in (2 cm)
Package 1 width	2.36 in (6 cm)
Package 1 Length	4.33 in (11 cm)
Unit Type of Package 2	S02
Number of Units in Package 2	97
Package 2 Weight	9.26 lb(US) (4.2 kg)
Package 2 Height	5.91 in (15 cm)
Package 2 width	11.81 in (30 cm)
Package 2 Length	15.75 in (40 cm)

Offer Sustainability

Sustainable offer status	Green Premium product
California proposition 65	WARNING: This product can expose you to chemicals including: Lead and lead compounds, which is known to the State of California to cause cancer and birth defects or other reproductive harm. For more information go to www.P65Warnings.ca.gov
REACH Regulation	REACH Declaration
REACH free of SVHC	Yes
EU RoHS Directive	Pro-active compliance (Product out of EU RoHS legal scope) EU RoHS Declaration
Toxic heavy metal free	Yes
Mercury free	Yes
RoHS exemption information	Yes
China RoHS Regulation	China RoHS Declaration
Environmental Disclosure	Product Environmental Profile
Circularity Profile	End Of Life Information

WEEE	The product must be disposed on European Union markets following specific waste collection and never end up in rubbish bins.
PVC free	Yes
Contractual warranty	
Warranty	18 months

TM5 Slice

Dimensions

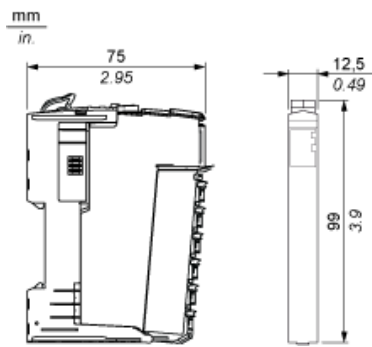

TM5 System

Spacing Requirements

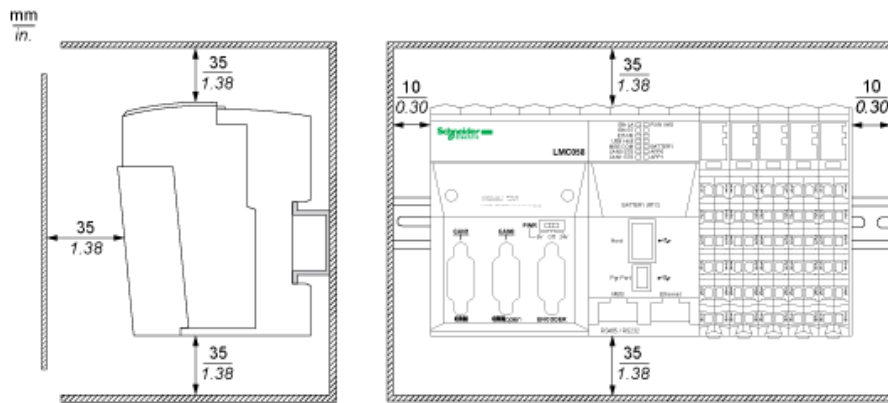



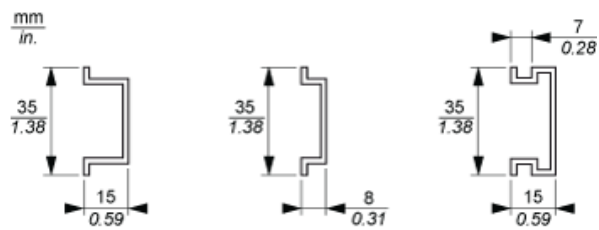

Mounting on a DIN Rail



TM5 System Wiring Recommendations

Wire Sizes to Use with the Removable Spring Terminal Blocks

mm in.				
mm ²	0,08...2,5	0,25...2,5	0,25...1,5	2 x 0,25...2 x 0,75
AWG	28...14	24...14	24...16	2 x 24...2 x 18

Electronic Module 2AI PT100/PT1000 16 Bits

Wiring Diagrams

The following figure shows the 2-wire wiring diagram:

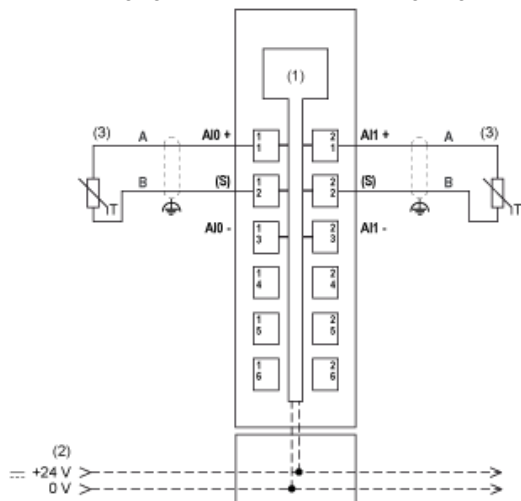

- (1) Internal electronics
- (2) 24 Vdc I/O power segment integrated into the bus bases
- (3) 2-wire sensor
- (S) Sensor

The following figure shows the 3-wire and 4-wire wiring diagram:

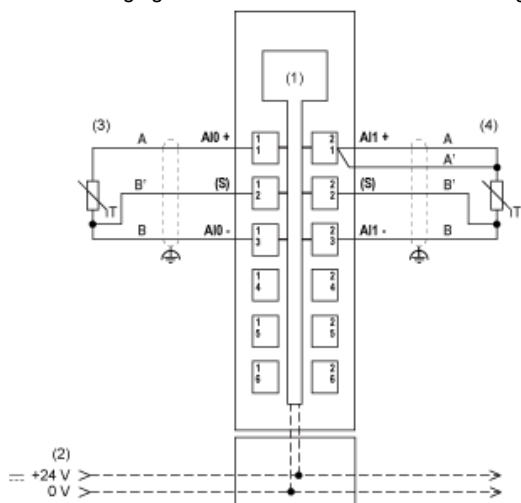

- (1) Internal electronics
- (2) 24 Vdc I/O power segment integrated into the bus bases
- (3) 3-wire sensor
- (4) 4-wire sensor
- (S) Sensor