

# Electrical Insulation Tester

420001



SPER  
SCIENTIFIC

Environmental Measurement

## **SAFETY INFORMATION**

- Read the following safety information carefully before attempting to operate or service the meter.
- To avoid damages to the instrument do not apply the signals which exceed the maximum limits shown in the technical specifications tables.
- Do not use the meter or test leads if they look damaged. Use extreme caution when working around bare conductors or bus bars.
- Accidental contact with the conductor could result in electric shock.
- Use the meter only as specified in this manual; otherwise, the protection provided by the meter may be impaired.
- Read the operating instructions before use and follow all safety Information.
- Caution when working with voltages above 60V DC or 30V AC RMS. Such voltages pose a shock hazard.
- Before taking resistance measurements or testing acoustic continuity, disconnect circuit from main power supply and all loads from the circuit.

## Safety symbols:



Caution refer to this manual before using the meter.



Dangerous voltages.



Meter is protected throughout by double insulation or reinforced insulation.

**When servicing, use only specified replacement parts.**

**CE** Comply with EN-61010-1

## 1. SPECIFICATIONS

### 1-1 General Information

#### Environment conditions:

- ① Installation Categories III
- ② Pollution Degree 2
- ③ Altitude up to 2000 meters
- ④ Indoor use only
- ⑤ Relatively humidity 80% max.
- ⑥ Operation Ambient 0~40°C

#### Maintenance & Clearing:

- ① Repairs or servicing not covered in this manual should only be performed by qualified personnel.
- ② Periodically wipe the case with a dry cloth. Do not use abrasives or solvents on this instruments.

**Display:** Large LCD with dual display

**Measurement Range:** 4000M $\Omega$ /125V, 4000M $\Omega$ /250V,  
4000M $\Omega$ /500V, 4000M $\Omega$ /1000V, 400 $\Omega$ /BZ,

1000V/DCV. ,750V/ACV

**Sampling Rate:** 2.5 times per second.

**Zero Adjustment:** Automatic adjustment.

**Over Range Indicator:** "OL" of highest digit is displayed.

**Low Battery Indication:** The  is displayed when the battery Voltage drop below the operating voltage.

**Operating Temperature:** 0°C to 40°C (32°F to 104°F) and Humidity below 80% RH

**Storage Temperature:** -10°C to 60°C (14°F to 140°F) and Humidity below 70% RH

**Power source:** DC9V (6x1.5V Size "AA" battery or Equivalent)

**Dimensions:** 200(L) x 92(W) x 50(H) mm

**Weight:** Approx 700g include battery

**Accessories:** Test leads, 6pcs battery, Carrying case, manual.

## 1-2 Electrical Specifications

Accuracies are specified in the way:

$\pm(\dots\% \text{ of reading} + \dots \text{digits})$  at  $23^{\circ}\text{C} \pm 5^{\circ}\text{C}$ , below 80% RH.

### OHMS

Range	Resolution	Accuracy	Max. open Circuit Voltage	Overload Protection
40.00 $\Omega$	0.01 $\Omega$	$\pm(1.2\%+3)$	5.8V	250Vrms
400.0 $\Omega$	0.1 $\Omega$		5.8V	

### Continuity Beeper

Range	Resolution	Operation Resistance	Max.open Circuit Voltage	Overload Protection
-------	------------	----------------------	--------------------------	---------------------

•)))	0.01Ω	Resistance $\leq$ 35Ω	5.8V	250Vrms
Short circuit current		$\cong$ 200mA		

### DC Voltage

Range	Resolution	Accuracy	Input Impedance	Overload Protection
1000V	1V	$\pm(0.8\%+3)$	10MΩ	1000Vrms

### AC Voltage (40Hz~400Hz)

Range	Resolution	Accuracy	Input Impedance	Overload Protection
750V	1V	$\pm(1.2\%+10)$	10MΩ	750Vrms

### Meg OHMS

Terminal Voltage	Range	Resolution	Accuracy	Test Current	Short circuit current
125V(0%~+10%)	0.125~4.000 MΩ	0.001MΩ	$\pm(2\%+10)$	1mA @load 125kΩ	$\leq$ 1mA
	4.001~40.00 MΩ	0.01MΩ	$\pm(2\%+10)$		
	40.01~400.0 MΩ	0.1MΩ	$\pm(4\%+5)$		
	400.1~4000 MΩ	1MΩ	$\pm(5\%+5)$		
250V(0%~+10%)	0.250~4.000 MΩ	0.001MΩ	$\pm(2\%+10)$	1mA @load 250kΩ	$\leq$ 1mA
	4.001~40.00 MΩ	0.01MΩ	$\pm(2\%+10)$		
	40.01~400.0 MΩ	0.1MΩ	$\pm(3\%+5)$		
	400.1~4000 MΩ	1MΩ	$\pm(4\%+5)$		
500V(0%~+10%)	0.500~4.000 MΩ	0.001MΩ	$\pm(2\%+10)$	1mA @load 500kΩ	$\leq$ 1mA
	4.001~40.00 MΩ	0.01MΩ	$\pm(2\%+10)$		
	40.01~400.0 MΩ	0.1MΩ	$\pm(2\%+5)$		

	400.1~4000 M $\Omega$	1M $\Omega$	$\pm(4\%+5)$		
1000V (0%~+1 0%)	1.000~4.000 M $\Omega$	0.001M $\Omega$	$\pm(3\%+10)$	1mA @load 1M $\Omega$	$\leq 1\text{mA}$
	4.001~40.00 M $\Omega$	0.01M $\Omega$	$\pm(2\%+10)$		
	40.01~400.0 M $\Omega$	0.1M $\Omega$	$\pm(2\%+5)$		
	400.1~4000 M $\Omega$	1M $\Omega$	$\pm(4\%+5)$		

## 2. PARTS & CONTROLS

- 1.Digital Display
- 2.Data Hold Button; MAX/MIN
- 3.Lock Button
- 4.Backlight Button; ZERO
- 5.Test Button
- 6.Rotary Function switch
- 7.V $\Omega$  Jack
- 8.COM input jack
9. Pothook
- 10.Battery Cover

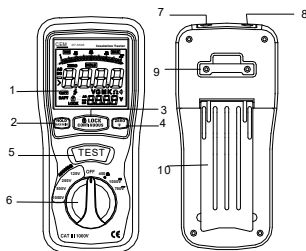

### 2-1 How to connect test leads.

On M $\Omega$  Range , and 400 $\Omega$ /BZ ,ACV,DCV, Connect the red test lead into the “V $\Omega$ ” terminal and the black lead into the “COM” terminal.

### 2-2 Battery Check-UP & Replacement

- a) As battery power is not sufficient. LCD will display  .  
Replacement of 6 pcs new batteries, type 1.5V size “AA” is Required.
- b). Place back the battery cover and four the screws.

### 2-3 Test leads check

Set the range select switch to the 400 $\Omega$  range. With the tip and

alligator clip of the test leads connected. The indicator should read 00.0Ω. When the leads are not connected the display will read infinity indicated by “OL”. This will ensure that test lead are under working condition.

#### **2-4 Rotary Switch positions**

Turn the Tester on by selecting any measurement

Lift < 1000v,500v,250v,125v (4000MΩ)

OFF 400Ω/BZ, 1000VDC,750VAC > Right

#### **2-5 Buttons and a display Indicators**

##### **a). Button**

**HOLD/MAX.MIN** : Instant-pressing the “HOLD” button the 1st time, the current values will be hold in the primary display., but it will return in the 2nd pressing ; pressing 2 seconds ,it will enter directly into the “MAX”status, and one another instant-pressing will switch to the “MIN”, if instant-pressing once more, it will recycle ,but exit if pressing 2 seconds again.

**LOCK** :In the insulation resistance testing function ,press the “LOCK” button ,and then push down the “ TEST” key, it will occur the high-voltage and enter the insulation resistance testing status. Press the “TEST” button once more ,it will shutoff the high-voltage and exit from the insulation resistance testing status.

**TEST** : In the insulation resistance testing function ,pressing and holding the “TEST” button, The meter will bring high-voltage, and enter into the insulation resistance testing, being free from the “TEST” , it will cutoff the high-voltage and exit form the insulation resistance testing.

**ZERO/LIGHT** :instant-pressing the “ZERO/LIGHT” button in the 1st time, the current values in the primary display will be set zero,(mainly used for 400Ω, the low resistance testing), ,it will return



if in the 2nd time. pressing for 2 seconds, it will enter directly into the "LIGHT" status, and the LCD backlight light up. After 15 seconds, the backlight is shut off automatically, the same as pressing for 2 seconds within 15s.

#### b) Display Indicators

The Primary Display: Indicate the current function testing values

The Secondary Display: It shows the output DCV while you test the insulation resistance, and the battery voltage while the ACV

The Analog Bar: indicate the current function testing value in synchronous with the primary display.

 :While testing the insulation resistance, the symbol " " flashes frequently if the voltage is over 30V.

•))) : While testing the insulation resistance, the symbol "•)))" " flashes frequently and the buzzer warns continually if the outside voltage is over 30V. the symbol "•)))" " is indicated while  $L0\Omega \leq 35\Omega$  and the BZ warns continuously.

**LOCK:** Push down the "LOCK" button while you test the insulation resistance and the symbol " Lock " is indicated.

LOBAT: The display shows "LOBAT" when the voltage drops below 7.5V

**MAX/MIN:**Stand for the maximum or the minimum.

**ZERO** : Digital zero adjusting.



**HOLD** :The digital holding function for the primary display.

**AC, DC,** :The indicator for the voltage property.

**V, MΩ, Ω** The measured dimension units.



### 3. INSULATION RESISTANCE MEASUREMENTS

- a) Turn the function switch from the "OFF" position to the left (4000 M $\Omega$ /1000V---4000/      M $\Omega$ 500V---4000      M $\Omega$ /250V---1000 M $\Omega$ /125V), and choose one of the voltage-block (there are 4 ranges namely, 4 M $\Omega$ 40 M $\Omega$ 400 M $\Omega$ 4000 M $\Omega$ , can be switched automatically for every voltage-block.)
- b) Connect two testing lines to the tested;
- c) Push down and hold the "TEST" button /or press the " LOCK" keystroke first and then the "TEST" button, if the tested is electriferous and its voltage ( AC/DC) is over 30V, it will refuse work and no high-voltage testing occurs, simultaneity, it shows ">30V" on the LCD, the symbol " " flashes, and the buzzer warns frequently. if the tested is diselectriferous or its voltage is lower than 30V, it will enter into the formal testing process and brings the high-voltage. on the primary display, the insulation resistance in M $\Omega$  is indicated in-phase with analog bar; on the secondary display, the tested insulation voltage in V (DC) is indicated, the symbol " " flashes and the buzzer warns frequently
- d) Being free from the "TEST" button or pushing down the "TEST" button in the "LOCK " status can exit from the "LOCK" status and shutoff the high-voltage, synchronously, the resistance values is indicated in the primary display will be held, and the secondary display still be in the status of monitoring the insulation voltage for the tested.
- e) Subsequently, discharge the balance insulation voltage of the tested through the inner switch of the meter.  
Turning the function switch can exit automatically from testing status during the process.

## 4. LOW RESISTANCE (CONTINUITY) MEASUREMENTS

- a). Set the range switch to 400 $\Omega$ /BZ Position
- b). Connect the red test lead to the V  $\Omega$  terminal and black to the COM terminal.
- c). Connect the tips of the test leads to both ends of the circuit under test. read resistance in  $\Omega$  on the LCD. The two ranges(40.00/400.0 $\Omega$ ) can be switched automatically; the primary display of the resistance in  $\Omega$ , flashes in synchronous with the analog bar.
- d). When the impedance on circuit is below approximately  $\leq 35\Omega$ . It will indicate by a continuous beeper.
- e) The current is from 200 to 220mA while the tested resistance is 0 $\Omega$
- f) The high voltage symbol “” flashes along with a primary display of “>30V” and the buzzer warns frequently if the voltage (AC/DC) is more than 30V.

## 5. AC/DC VOLTAGE MEASUREMENTS

- a). Set the range switch to ACV or DCV position
- b). Connect red test lead to “V  $\Omega$ ” terminal and black test lead to terminal “COM”.
- c). Connect test prods of test leads IN PARALLEL to the circuit being measured.
- d). Read the voltage value on LCD.

## **6.BATTERY SAVER (SLEEP MODE)**

The meter will automatically enter the “sleep mode” if there is no function change or button press for 10minutes, but it works as soon as you turn the rotary function switch or push down any button.

## **7.POWER TOOLS AND AMALL APPLIANCES**

This test would also apply to other similar equipment that has a line cord. For double insulated power tools, the megohmmeter lead shown connected to the housing would be connected to some metal part If the tool(e..g chuck,blade).

Note: The switch of the device must be in the “ON” position and the main power should be disconnected.

### **MOTORS**

AC-Disconnect the motor from the line by disconnecting the wires at the motor terminals or by opening the main switch. If the main switch is used and the motor also has a starter then the starter must be held, by some means, in the “ON” position. In the latter case, the measured resistance will include the resistance of the motor, wire and all other components between the motor and the main switch. If a weakness is indicated, the motor and other components should be checked individually. If the motor is disconnected at the motor terminals, connect one megohmmeter lead to the grounded motor housing and the other lead to One of the motor leads.

DC-Disconnect the motor from the line. To test the brush rigging, field coils and armature connect one megohmmeter lead to the grounded motor housing and the other lead to the brush on the commutator. If the resistance measurement indicates a weakness, raise the brushes off the commutator and separately test the

armature, field coils and brush rigging by connecting one megohmmeter lead to each of them individually, leaving the other connected to the grounded motor housing. The above also applies to DC Generators.

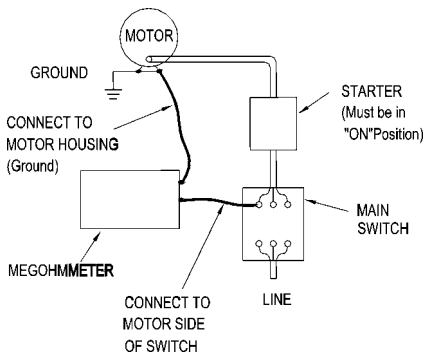

## CABLES

Disconnect the cable from the line. Also disconnect opposite end to avoid errors due to leakage from other equipment. Check each conductor to ground and /or lead sheath by connecting one megohmmeter lead to a ground and /or lead sheather and the other megohmmeter lead to each of the conductors in turn. Check insulation resistance between conductors by connecting megohmmeter leads to conductors in pairs.

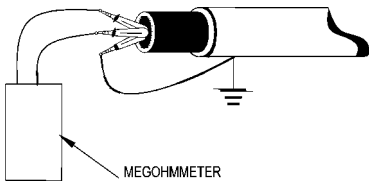

## **WARRANTY**

Sper Scientific warrants this product against defects in materials and workmanship for a period of **one (1) year** from the date of purchase, and agrees to repair or replace any defective unit without charge. If your model has since been discontinued, an equivalent Sper Scientific product will be substituted if available. This warranty does not cover probes, batteries, battery leakage, or damage resulting from accident, tampering, misuse, or abuse of the product. Opening the meter to expose its electronics will break the waterproof seal and void the warranty.

To obtain warranty service, ship the unit postage prepaid to:

**SPER SCIENTIFIC LTD.**

8281 East Evans Road, Suite #103  
Scottsdale, AZ 85260

The defective unit must be accompanied by a description of the problem and your return address. Register your product online at [www.sperwarranty.com](http://www.sperwarranty.com) within 10 days of purchase.