

NO. OF CKTS.	DIM. A	DIM. B
1	(2.44 ± .15) .096 ± .006	—
2	(4.98 ± .15) .196 ± .006	(2.54 ± .10) .100 ± .004
3	(7.52 ± .15) .296 ± .006	(5.08 ± .10) .200 ± .004
4	(10.06 ± .15) .396 ± .006	(7.62 ± .10) .300 ± .004
5	(12.60 ± .18) .496 ± .007	(10.16 ± .13) .400 ± .005
6	(15.14 ± .18) .596 ± .007	(12.70 ± .13) .500 ± .005
7	(17.68 ± .20) .696 ± .008	(15.24 ± .15) .600 ± .006
8	(20.22 ± .20) .796 ± .008	(17.78 ± .15) .700 ± .006
9	(22.76 ± .20) .896 ± .008	(20.32 ± .15) .800 ± .006
10	(25.30 ± .25) .996 ± .010	(22.86 ± .20) .900 ± .008
11	(27.84 ± .25) 1.096 ± .010	(25.40 ± .20) 1.000 ± .008
12	(30.38 ± .25) 1.196 ± .010	(27.94 ± .20) 1.100 ± .008
13	(32.92 ± .25) 1.296 ± .010	(30.48 ± .20) 1.200 ± .008
14	(35.46 ± .25) 1.396 ± .010	(33.02 ± .20) 1.300 ± .008
15	(38.00 ± .28) 1.496 ± .011	(35.56 ± .23) 1.400 ± .009
16	(40.54 ± .28) 1.596 ± .011	(38.10 ± .23) 1.500 ± .009
17	(43.08 ± .28) 1.696 ± .011	(40.64 ± .23) 1.600 ± .009
18	(45.62 ± .28) 1.796 ± .011	(43.18 ± .23) 1.700 ± .009
19	(48.16 ± .28) 1.896 ± .011	(45.72 ± .23) 1.800 ± .009
20	(50.70 ± .30) 1.996 ± .012	(48.26 ± .25) 1.900 ± .010

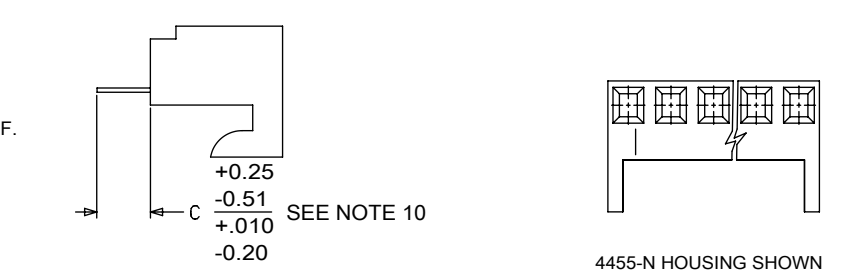
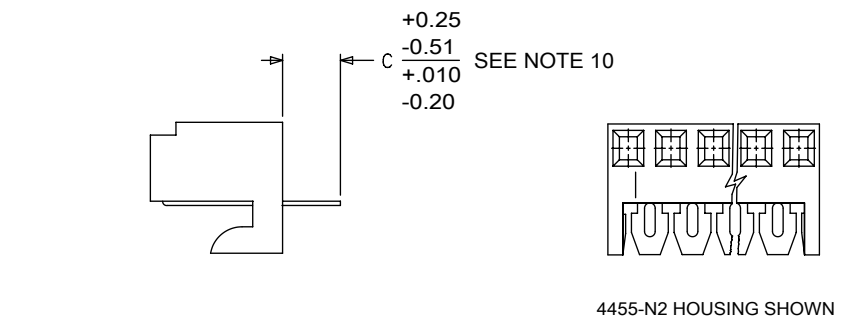
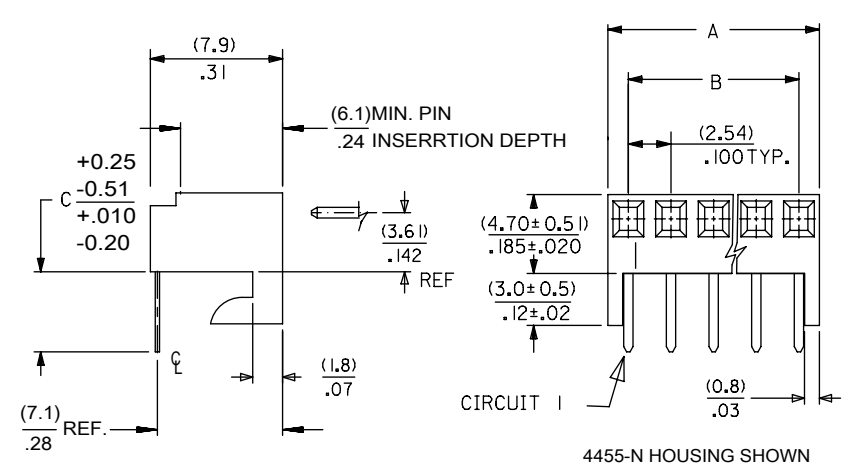
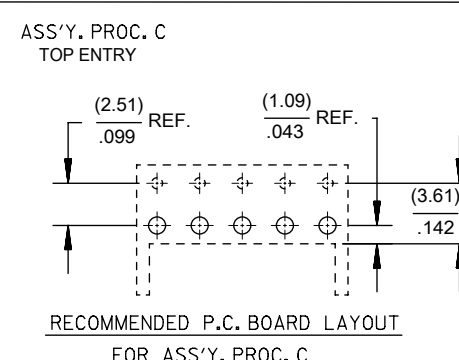
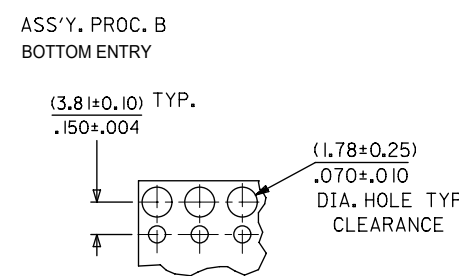
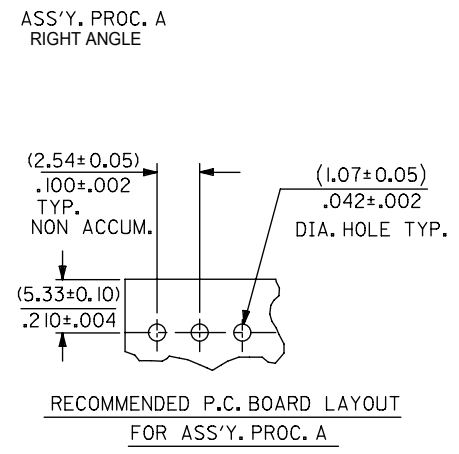

RECOMMENDED P.C. BOARD LAYOUT FOR ASS'Y. PROC. A

RECOMMENDED P.C. BOARD LAYOUT FOR ASS'Y. PROC. B

RECOMMENDED P.C. BOARD LAYOUT FOR ASS'Y. PROC. C

- NOTES:
- MATERIAL: NYLON, UL 94V-0, COLOR: WHITE
  - FINISH:
    - (208) - SELECT GOLD: (0.00038)/.000015 MIN., SELECT TIN: (0.00254)/.000100 MIN. OVERALL NICKEL UNDERPLATE: (0.00127)/.000050 MIN.
    - (228) - SELECT GOLD: (0.00076)/.000030 MIN., SELECT TIN: (0.00254)/.000100 MIN. OVERALL NICKEL UNDERPLATE: (0.00127)/.000050 MIN.
    - (231) - SELECT GOLD: (0.00127)/.000050 MIN., SELECT TIN: (0.00254)/.000100 MIN. OVERALL NICKEL UNDERPLATE: (0.00127)/.000050 MIN.
    - (565) - SELECT GOLD: (0.00051)/.000020 MIN., OVERALL NICKEL: (0.00076)/.000030 MIN. OVERALL GOLD FLASH: (0.00005)/.000002 MIN.
    - (P909) - OVERALL TIN: (0.00254)/.000100 MIN.
  - PARTS CONFORM TO PRODUCT SPECIFICATION PS-10-07.
  - PACKAGING: SEE CHARTS.
  - PARTS MUST CONFORM TO SOLDERABILITY SPEC 152.
  - PARTS ARE STACKABLE END TO END ON (2.54)/.100 CENTERS.
  - TYPICAL PCB THICKNESS: (1.57)/.062
  - PART CONFORMS TO CLASS B REQUIREMENTS OF COSMETIC SPECIFICATION PS-45499-002 EXCEPT PROTRUSIONS. PARTS MAY HAVE MORE THAN 2 GATE MARKS.
  - WHEN MATING ASSEMBLIES THAT USE 4455-BN HOUSINGS TO BREAKAWAY FRICTION LOCK OR POLARIZING HEADERS, THE END BACKWALLS MUST BE REMOVED.
  - DIMENSION C MEASURED WITH TERMINAL PUSHED IN AGAINST THE STOP.

DOCUMENT STATUS	P1	RELEASE DATE	2018/08/13	11:53:00
-----------------	----	--------------	------------	----------

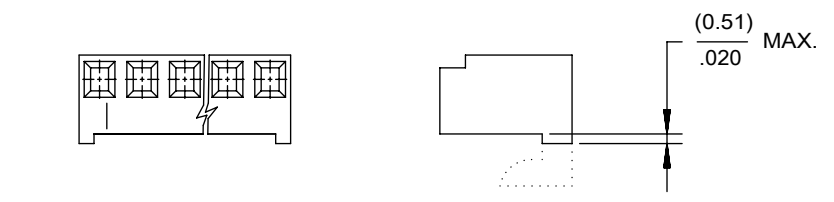
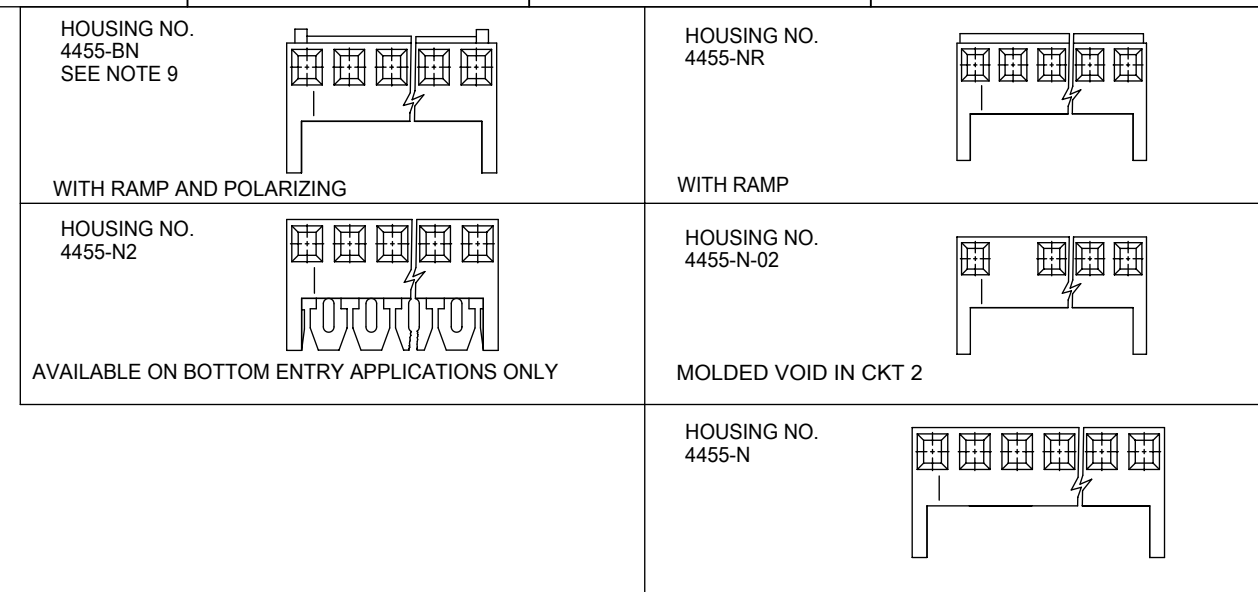

HOOKS CUT OPTION AVAILABLE ON TOP ENTRY, SEE CHART

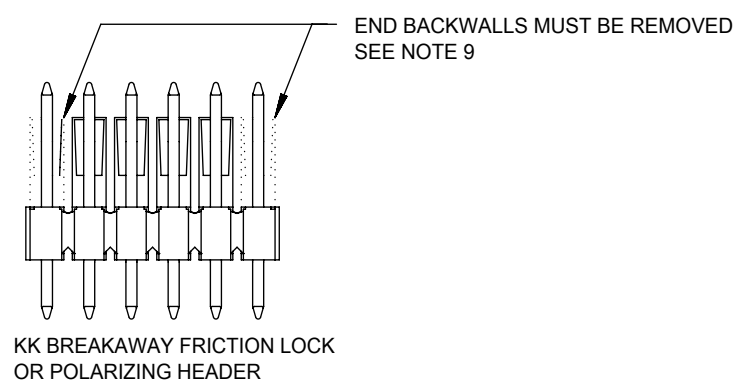

SYMBOLS		THIS DRAWING CONTAINS INFORMATION THAT IS PROPRIETARY TO MOLEX ELECTRONIC TECHNOLOGIES, LLC AND SHOULD NOT BE USED WITHOUT WRITTEN PERMISSION		CURRENT REV DESC: ADDED NEW P/N'S	
▽ = 0	DIMENSION UNITS	SCALE			
▽ = 0	MM/IN	1:1			
▽ = 0	GENERAL TOLERANCES (UNLESS SPECIFIED)				
▽ = 0		MM	INCH		
▽ = 0	4 PLACES	±	±		
▽ = 0	3 PLACES	±	± 0.01		
▽ = 0	2 PLACES	± 0.25	± 0.015		
▽ = 0	1 PLACE	± 0.36	±		
▽ = 0	0 PLACES	±	±		
▽ = 0	ANGULAR TOL		± 0.5°		
▽ = 0	DRAFT WHERE APPLICABLE MUST REMAIN WITHIN DIMENSIONS		THIRD ANGLE PROJECTION	DRAWING	SERIES
▽ = 0				B-SIZE	4455
		EC NO: 602687		2018/06/18	
		DRWN: SS06		2018/08/13	
		CHK'D: ISHWARG		2018/08/13	
		APPR: ISHWARG		2018/08/13	
		INITIAL REVISION:			
		DRWN: SAMIEC		1984/05/10	
		APPR: LENZ		1984/05/10	
		MATERIAL NUMBER		CUSTOMER	
		SEE CHART		GENERAL MARKET	
		SHEET		REV.	
		2-*		D15	
		1		D16	
		SDA-4455		PSD 001 D16	
		DOCUMENT NUMBER		DOC TYPE DOC PART REVISION	
		SDA-4455		PSD 001 D16	
		MATERIAL NUMBER		CUSTOMER	
		SEE CHART		GENERAL MARKET	
		SHEET NUMBER		1 OF 1	



# KK 100 PCB ASSY 2-20 CKT

## 4455 SERIES

STANDARD PRODUCT

**A-4455- \* \* N \* \* - \* - \***

↑      ↑      ↑      ↑      ↑      ↑      ↑

**ASSY PROCEDURE**  
 A=RIGHT ANGLE  
 B=BOTTOM ENTRY  
 C=TOP ENTRY

**HOUSING OPTION**  
 B=4455-BN  
 G=4455-BN (HOOKS CUT OFF)  
 H=4455-N2 (BOTTOM ENTRY ONLY)  
 P=4455-NR (HOOKS CUT OFF)  
 R=4455-NR  
 V=4455-N-02  
 W=4455-N-02 (HOOKS CUT OFF)  
 Y=4455-N (HOOKS CUT OFF)  
 Z=4455-N

**NO OF CIRCUITS** \_\_\_\_\_

**TERMINAL TYPE**

Code	Number	Material	Form
A	4316-4	Brass	Standard
B	6516-4	Phos Bronze	Standard
C	6516-5C	Phos Bronze	Cat Ear / V
D	4316-3B	Brass	Std / V
F	6516-6C	Phos Bronze	Cat Ear / V
G	4316-3	Brass	Standard
J	6516-3B	Phos Bronze	Std / V
L	6516-3C	Phos Bronze	Cat Ear / V
M	6516-4A	Phos Bronze	Cat Ear
T	4316-4A	Brass	Cat Ear

**VOID LOCATION NUMBER = CIRCUIT**  
 VOIDED  
 MULTIPLE VOIDS START WITH 51  
 BLANK = NONE

**PACKAGING**  
 A = TRAY  
 B = TAPE AND REEL

**PLATING**  
 (SEE SHEET 1)

Assy Proc:	RIGHT ANGLE
Hooks Cut:	NO
Housing No:	4455-N
Terminal No:	4316-4(P909)
Dim C:	3.35 / .132
Plating:	P909
Packaging:	PK-44646-001
Voids:	NONE

Assy Proc:	RIGHT ANGLE
Hooks Cut:	NO
Housing No:	4455-N
Terminal No:	4316-4(565)
Dim C:	3.35 / .132
Plating:	565
Packaging:	PK-44646-001
Voids:	NONE

Ckts	Material No	Engineer Number
2	22-15-2026	A-4455-AZ02A(P909)
3	22-15-2036	A-4455-AZ03A(P909)
4	22-15-2046	A-4455-AZ04A(P909)
5	22-15-2056	A-4455-AZ05A(P909)
6	22-15-2066	A-4455-AZ06A(P909)
7	22-15-2076	A-4455-AZ07A(P909)
8	22-15-2086	A-4455-AZ08A(P909)
9	22-15-2096	A-4455-AZ09A(P909)
10	22-15-2106	A-4455-AZ10A(P909)
11	22-15-2116	A-4455-AZ11A(P909)
12	22-15-2126	A-4455-AZ12A(P909)
13	22-15-2136	A-4455-AZ13A(P909)
14	22-15-2146	A-4455-AZ14A(P909)
15	22-15-2156	A-4455-AZ15A(P909)
16	22-15-2166	A-4455-AZ16A(P909)
17	22-15-2176	A-4455-AZ17A(P909)
18	22-15-2186	A-4455-AZ18A(P909)
19	22-15-2196	A-4455-AZ19A(P909)
20	22-15-2206	A-4455-AZ20A(P909)

Material No	Engineer Number
22-16-2021	A-4455-AZ02A(565)
22-16-2031	A-4455-AZ03A(565)
22-16-2041	A-4455-AZ04A(565)
22-16-2051	A-4455-AZ05A(565)
22-16-2061	A-4455-AZ06A(565)
22-16-2071	A-4455-AZ07A(565)
22-16-2081	A-4455-AZ08A(565)
22-16-2091	A-4455-AZ09A(565)
22-16-2101	A-4455-AZ10A(565)
22-16-2111	A-4455-AZ11A(565)
22-16-2121	A-4455-AZ12A(565)
22-16-2131	A-4455-AZ13A(565)
22-16-2141	A-4455-AZ14A(565)
22-16-2151	A-4455-AZ15A(565)
22-16-2161	A-4455-AZ16A(565)
22-16-2171	A-4455-AZ17A(565)
22-16-2181	A-4455-AZ18A(565)
22-16-2191	A-4455-AZ19A(565)
22-16-2201	A-4455-AZ20A(565)

<b>REV:</b>  <b>D15</b>	<b>ECM INFORMATION:</b> ECM No.: <b>602687</b> DATE: <b>22/06/2018</b>	<b>TITLE:</b>  <b>KK 100 PCB ASSY 4455 SERIES DWG</b>	<b>SHEET No.</b>  <b>- 2 -</b>
<b>DOCUMENT NUMBER:</b> <b>SDA-4455</b>	<b>DOC TYPE:</b> <b>PSD</b>	<b>DOC PART:</b> <b>002</b>	<b>CREATED / REVISED BY:</b> <b>SS06</b>
<b>CHECKED BY:</b> <b>SS06</b>		<b>APPROVED BY:</b> <b>ISHWARG</b>	



# KK 100 PCB ASSY 2-20 CKT

## 4455 SERIES

STANDARD PRODUCT

Ckts	Assy Proc: RIGHT ANGLE		Assy Proc: BOTTOM ENTRY		Assy Proc: BOTTOM ENTRY		Assy Proc: BOTTOM ENTRY	
	Hooks Cut:	NO	Hooks Cut:	NO	Hooks Cut:	NO	Hooks Cut:	NO
	Housing No:	4455-N	Housing No:	4455-N2	Housing No:	4455-N2	Housing No:	4455-N2
	Terminal No:	4316-4(208)	Terminal No:	4316-3B(P909)	Terminal No:	4316-3B(565)	Terminal No:	4316-3B(208)
	Dim C:	3.35 / .132	Dim C:	3.35 / .132	Dim C:	3.35 / .132	Dim C:	3.35 / .132
	Plating:	208	Plating:	P909	Plating:	565	Plating:	208
	Packaging:	PK-44646-001	Packaging:	PK-44646-001	Packaging:	PK-44646-001	Packaging:	PK-44646-001
	Voids:	NONE	Voids:	NONE	Voids:	NONE	Voids:	NONE
	Material No	Engineer Number	Material No	Engineer Number	Material No	Engineer Number	Material No	Engineer Number
2	22-16-2020	A-4455-AZ02A(208)	22-14-2024	A-4455-BH02D(P909)	22-17-2022	A-4455-BH02D(565)	22-17-3022	A-4455-BH02D(208)
3	22-16-2030	A-4455-AZ 03 A(208)	22-14-2034	A-4455-BH 03 D(P909)	22-17-2032	A-4455-BH 03 D(565)	22-17-3032	A-4455-BH 03 D(208)
4	22-16-2040	A-4455-AZ 04 A(208)	22-14-2044	A-4455-BH 04 D(P909)	22-17-2042	A-4455-BH 04 D(565)	22-17-3042	A-4455-BH 04 D(208)
5	22-16-2050	A-4455-AZ 05 A(208)	22-14-2054	A-4455-BH 05 D(P909)	22-17-2052	A-4455-BH 05 D(565)	22-17-3052	A-4455-BH 05 D(208)
6	22-16-2060	A-4455-AZ 06 A(208)	22-14-2064	A-4455-BH 06 D(P909)	22-17-2062	A-4455-BH 06 D(565)	22-17-3062	A-4455-BH 06 D(208)
7	22-16-2070	A-4455-AZ 07 A(208)	22-14-2074	A-4455-BH 07 D(P909)	22-17-2072	A-4455-BH 07 D(565)	22-17-3072	A-4455-BH 07 D(208)
8	22-16-2080	A-4455-AZ 08 A(208)	22-14-2084	A-4455-BH 08 D(P909)	22-17-2082	A-4455-BH 08 D(565)	22-17-3082	A-4455-BH 08 D(208)
9	22-16-2090	A-4455-AZ 09 A(208)	22-14-2094	A-4455-BH 09 D(P909)	22-17-2092	A-4455-BH 09 D(565)	22-17-3092	A-4455-BH 09 D(208)
10	22-16-2100	A-4455-AZ 10 A(208)	22-14-2104	A-4455-BH 10 D(P909)	22-17-2102	A-4455-BH 10 D(565)	22-17-3102	A-4455-BH 10 D(208)
11	22-16-2110	A-4455-AZ 11 A(208)	22-14-2114	A-4455-BH 11 D(P909)	22-17-2112	A-4455-BH 11 D(565)	22-17-3112	A-4455-BH 11 D(208)
12	22-16-2120	A-4455-AZ 12 A(208)	22-14-2124	A-4455-BH 12 D(P909)	22-17-2122	A-4455-BH 12 D(565)	22-17-3122	A-4455-BH 12 D(208)
13	22-16-2130	A-4455-AZ 13 A(208)	22-14-2134	A-4455-BH 13 D(P909)	22-17-2132	A-4455-BH 13 D(565)	22-17-3132	A-4455-BH 13 D(208)
14	22-16-2140	A-4455-AZ 14 A(208)	22-14-2144	A-4455-BH 14 D(P909)	22-17-2142	A-4455-BH 14 D(565)	22-17-3142	A-4455-BH 14 D(208)
15	22-16-2150	A-4455-AZ 15 A(208)	22-14-2154	A-4455-BH 15 D(P909)	22-17-2152	A-4455-BH 15 D(565)	22-17-3152	A-4455-BH 15 D(208)
16	22-16-2160	A-4455-AZ 16 A(208)	22-14-2164	A-4455-BH 16 D(P909)	22-17-2162	A-4455-BH 16 D(565)	22-17-3162	A-4455-BH 16 D(208)
17	22-16-2170	A-4455-AZ 17 A(208)	22-14-2174	A-4455-BH 17 D(P909)	22-17-2172	A-4455-BH 17 D(565)	22-17-3172	A-4455-BH 17 D(208)
18	22-16-2180	A-4455-AZ 18 A(208)	22-14-2184	A-4455-BH 18 D(P909)	22-17-2182	A-4455-BH 18 D(565)	22-17-3182	A-4455-BH 18 D(208)
19	22-16-2190	A-4455-AZ 19 A(208)	22-14-2194	A-4455-BH 19 D(P909)	22-17-2192	A-4455-BH 19 D(565)	22-17-3192	A-4455-BH 19 D(208)
20	22-16-2200	A-4455-AZ 20 A(208)	22-14-2204	A-4455-BH 20 D(P909)	22-17-2202	A-4455-BH 20 D(565)	22-17-3202	A-4455-BH 20 D(208)

REV:	<b>ECM INFORMATION:</b>	<u>TITLE:</u>	<h1 style="margin: 0;">KK 100 PCB ASSY</h1> <h2 style="margin: 0;">4455 SERIES DWG</h2>	<u>SHEET No.</u>	
<b>D15</b>	ECM No.: <b>602687</b>			<b>- 3 -</b>	
	DATE: <b>22/06/2018</b>				
<u>DOCUMENT NUMBER:</u>	<u>DOC TYPE:</u>	<u>DOC PART:</u>	<u>CREATED / REVISED BY:</u>	<u>CHECKED BY:</u>	<u>APPROVED BY:</u>
<b>SDA-4455</b>	<b>PSD</b>	<b>002</b>	<b>SS06</b>	<b>SS06</b>	<b>ISHWARG</b>



# KK 100 PCB ASSY 2-20 CKT

## 4455 SERIES

Assy Proc:	TOP ENTRY
Hooks Cut:	NO
Housing No:	4455-N
Terminal No:	4316-4(P909)
Dim C:	3.35 / .132
Plating:	P909
Packaging:	PK-44646-001
Voids:	NONE

Assy Proc:	TOP ENTRY
Hooks Cut:	NO
Housing No:	4455-N
Terminal No:	4316-4(565)
Dim C:	3.35 / .132
Plating:	565
Packaging:	PK-44646-001
Voids:	NONE

Assy Proc:	TOP ENTRY
Hooks Cut:	NO
Housing No:	4455-N
Terminal No:	4316-4(208)
Dim C:	3.35 / .132
Plating:	208
Packaging:	PK-44646-001
Voids:	NONE

Assy Proc:	TOP ENTRY
Hooks Cut:	NO
Housing No:	4455-N
Terminal No:	6516-4(P909)
Dim C:	3.35 / .132
Plating:	P909
Packaging:	PK-44646-001
Voids:	NONE

Ckts
2
3
4
5
6
7
8
9
10
11
12
13
14
15
16
17
18
19
20

Material No	Engineer Number
22-02-2025	A-4455-CZ02A(P909)
22-02-2035	A-4455-CZ 03A(P909)
22-02-2045	A-4455-CZ 04A(P909)
22-02-2055	A-4455-CZ 05A(P909)
22-02-2065	A-4455-CZ 06A(P909)
22-02-2075	A-4455-CZ 07A(P909)
22-02-2085	A-4455-CZ 08 A(P909)
22-02-2095	A-4455-CZ 09 A(P909)
22-02-2105	A-4455-CZ 10 A(P909)
22-02-2115	A-4455-CZ 11 A(P909)
22-02-2125	A-4455-CZ 12 A(P909)
22-02-2135	A-4455-CZ 13 A(P909)
22-02-2145	A-4455-CZ 14 A(P909)
22-02-2155	A-4455-CZ 15 A(P909)
22-02-2165	A-4455-CZ 16 A(P909)
22-02-2175	A-4455-CZ 17 A(P909)
22-02-2185	A-4455-CZ 18 A(P909)
22-02-2195	A-4455-CZ 19 A(P909)
22-02-2205	A-4455-CZ 20 A(P909)

Material No	Engineer Number
22-18-2023	A-4455-CZ02A(565)
22-18-2033	A-4455-CZ 03 A(565)
22-18-2043	A-4455-CZ 04 A(565)
22-18-2053	A-4455-CZ 05 A(565)
22-18-2063	A-4455-CZ 06 A(565)
22-18-2073	A-4455-CZ 07 A(565)
22-18-2083	A-4455-CZ 08 A(565)
22-18-2093	A-4455-CZ 09 A(565)
22-18-2103	A-4455-CZ 10 A(565)
22-18-2113	A-4455-CZ 11 A(565)
22-18-2123	A-4455-CZ 12 A(565)
22-18-2133	A-4455-CZ 13 A(565)
22-18-2143	A-4455-CZ 14 A(565)
22-18-2153	A-4455-CZ 15 A(565)
22-18-2163	A-4455-CZ 16 A(565)
22-18-2173	A-4455-CZ 17 A(565)
22-18-2183	A-4455-CZ 18 A(565)
22-18-2193	A-4455-CZ 19 A(565)
22-18-2203	A-4455-CZ 20 A(565)

Material No	Engineer Number
22-18-2021	A-4455-CZ02A(208)
22-18-2031	A-4455-CZ 03 A(208)
22-18-2041	A-4455-CZ 04 A(208)
22-18-2051	A-4455-CZ 05 A(208)
22-18-2061	A-4455-CZ 06 A(208)
22-18-2071	A-4455-CZ 07 A(208)
22-18-2081	A-4455-CZ 08 A(208)
22-18-2091	A-4455-CZ 09 A(208)
22-18-2101	A-4455-CZ 10 A(208)
22-18-2111	A-4455-CZ 11 A(208)
22-18-2121	A-4455-CZ 12 A(208)
22-18-2131	A-4455-CZ 13 A(208)
22-18-2141	A-4455-CZ 14 A(208)
22-18-2151	A-4455-CZ 15 A(208)
22-18-2161	A-4455-CZ 16 A(208)
22-18-2171	A-4455-CZ 17 A(208)
22-18-2181	A-4455-CZ 18 A(208)
22-18-2191	A-4455-CZ 19 A(208)
22-18-2201	A-4455-CZ 20 A(208)

Material No	Engineer Number
22-15-4025	A-4455-AZ02B(P909)
22-15-4035	A-4455-AZ 03B(P909)
22-15-4045	A-4455-AZ 04B(P909)
22-15-4055	A-4455-AZ 05B(P909)
22-15-4065	A-4455-AZ 06B(P909)
22-15-4075	A-4455-AZ 07B(P909)
22-15-4085	A-4455-AZ 08B(P909)
22-15-4095	A-4455-AZ 09B(P909)
22-15-4105	A-4455-AZ 10B(P909)
22-15-4115	A-4455-AZ 11B(P909)
22-15-4125	A-4455-AZ 12B(P909)
22-15-4135	A-4455-AZ 13B(P909)
22-15-4145	A-4455-AZ 14B(P909)
22-15-4155	A-4455-AZ 15B(P909)
22-15-4165	A-4455-AZ 16B(P909)
22-15-4175	A-4455-AZ 17B(P909)
22-15-4185	A-4455-AZ 18B(P909)
22-15-4195	A-4455-AZ 19B(P909)
22-15-4205	A-4455-AZ 20B(P909)

REV:	<b>ECM INFORMATION:</b>	<u>TITLE:</u>	<b>KK 100 PCB ASSY 4455 SERIES DWG</b>	<u>SHEET No.</u>	
<b>D15</b>	ECM No.: <b>602687</b>			<b>- 4 -</b>	
	DATE: <b>22/06/2018</b>				
<u>DOCUMENT NUMBER:</u>	<u>DOC TYPE:</u>	<u>DOC PART:</u>	<u>CREATED / REVISED BY:</u>	<u>CHECKED BY:</u>	<u>APPROVED BY:</u>
<b>SDA-4455</b>	<b>PSD</b>	<b>002</b>	<b>SS06</b>	<b>SS06</b>	<b>ISHWARG</b>



# KK 100 PCB ASSY 2-20 CKT

## 4455 SERIES

Assy Proc:	RIGHT ANGLE
Hooks Cut:	NO
Housing No:	4455-N
Terminal No:	6516-4(565)
Dim C:	3.35 / .132
Plating:	565
Packaging:	PK-44646-001
Voids:	NONE

Assy Proc:	RIGHT ANGLE
Hooks Cut:	NO
Housing No:	4455-N
Terminal No:	6516-4(208)
Dim C:	3.35 / .132
Plating:	208
Packaging:	PK-44646-001
Voids:	NONE

Assy Proc:	BOTTOM ENTRY
Hooks Cut:	NO
Housing No:	4455-N2
Terminal No:	6516-3B(565)
Dim C:	3.35 / .132
Plating:	565
Packaging:	PK-44646-001
Voids:	NONE

Assy Proc:	BOTTOM ENTRY
Hooks Cut:	NO
Housing No:	4455-N2
Terminal No:	6516-3B(208)
Dim C:	3.35 / .132
Plating:	208
Packaging:	PK-44646-001
Voids:	NONE

Ckts	Material No	Engineer Number	Material No	Engineer Number	Material No	Engineer Number	Material No	Engineer Number
2	22-16-2024	A-4455-AZ02B(565)		A-4455-AZ02B(208)	22-17-2021	A-4455-BH02J(565)		A-4455-BH02J(208)
3	22-16-2034	A-4455-AZ 03 B(565)		A-4455-AZ 03 B(208)	22-17-2031	A-4455-BH 03 J(565)		A-4455-BH 03 J(208)
4	22-16-2044	A-4455-AZ 04 B(565)		A-4455-AZ 04 B(208)	22-17-2041	A-4455-BH 04 J(565)		A-4455-BH 04 J(208)
5	22-16-2054	A-4455-AZ 05 B(565)		A-4455-AZ 05 B(208)	22-17-2051	A-4455-BH 05 J(565)		A-4455-BH 05 J(208)
6	22-16-2064	A-4455-AZ 06 B(565)		A-4455-AZ 06 B(208)	22-17-2061	A-4455-BH 06 J(565)		A-4455-BH 06 J(208)
7	22-16-2074	A-4455-AZ 07 B(565)		A-4455-AZ 07 B(208)	22-17-2071	A-4455-BH 07 J(565)		A-4455-BH 07 J(208)
8	22-16-2084	A-4455-AZ 08 B(565)		A-4455-AZ 08 B(208)	22-17-2081	A-4455-BH 08 J(565)		A-4455-BH 08 J(208)
9	22-16-2094	A-4455-AZ 09 B(565)		A-4455-AZ 09 B(208)	22-17-2091	A-4455-BH 09 J(565)		A-4455-BH 09 J(208)
10	22-16-2104	A-4455-AZ 10 B(565)		A-4455-AZ 10 B(208)	22-17-2101	A-4455-BH 10 J(565)		A-4455-BH 10 J(208)
11	22-16-2114	A-4455-AZ 11 B(565)		A-4455-AZ 11 B(208)	22-17-2111	A-4455-BH 11 J(565)		A-4455-BH 11 J(208)
12	22-16-2124	A-4455-AZ 12 B(565)		A-4455-AZ 12 B(208)	22-17-2121	A-4455-BH 12 J(565)		A-4455-BH 12 J(208)
13	22-16-2134	A-4455-AZ 13 B(565)		A-4455-AZ 13 B(208)	22-17-2131	A-4455-BH 13 J(565)		A-4455-BH 13 J(208)
14	22-16-2144	A-4455-AZ 14 B(565)		A-4455-AZ 14 B(208)	22-17-2141	A-4455-BH 14 J(565)		A-4455-BH 14 J(208)
15	22-16-2154	A-4455-AZ 15 B(565)		A-4455-AZ 15 B(208)	22-17-2151	A-4455-BH 15 J(565)		A-4455-BH 15 J(208)
16	22-16-2164	A-4455-AZ 16 B(565)		A-4455-AZ 16 B(208)	22-17-2161	A-4455-BH 16 J(565)		A-4455-BH 16 J(208)
17	22-16-2174	A-4455-AZ 17 B(565)		A-4455-AZ 17 B(208)	22-17-2171	A-4455-BH 17 J(565)		A-4455-BH 17 J(208)
18	22-16-2184	A-4455-AZ 18 B(565)		A-4455-AZ 18 B(208)	22-17-2181	A-4455-BH 18 J(565)		A-4455-BH 18 J(208)
19	22-16-2194	A-4455-AZ 19 B(565)		A-4455-AZ 19 B(208)	22-17-2191	A-4455-BH 19 J(565)		A-4455-BH 19 J(208)
20	22-16-2204	A-4455-AZ 20 B(565)		A-4455-AZ 20 B(208)	22-17-2201	A-4455-BH 20 J(565)		A-4455-BH 20 J(208)

REV:	<b>ECM INFORMATION:</b>	TITLE:	<h1 style="margin: 0;">KK 100 PCB ASSY</h1> <h2 style="margin: 0;">4455 SERIES DWG</h2>		SHEET No.
D15	ECM No.: 602687				- 5 -
	DATE: 22/06/2018				
DOCUMENT NUMBER:	DOC TYPE:	DOC PART:	CREATED / REVISED BY:	CHECKED BY:	APPROVED BY:
SDA-4455	PSD	002	SS06	SS06	ISHWARG



# KK 100 PCB ASSY 2-20 CKT

## 4455 SERIES

Assy Proc:	TOP ENTRY
Hooks Cut:	NO
Housing No:	4455-N
Terminal No:	6516-4(P909)
Dim C:	3.35 / .132
Plating:	P909
Packaging:	PK-44646-001
Voids:	NONE

Assy Proc:	TOP ENTRY
Hooks Cut:	NO
Housing No:	4455-N
Terminal No:	6516-4(565)
Dim C:	3.35 / .132
Plating:	565
Packaging:	PK-44646-001
Voids:	NONE

Assy Proc:	TOP ENTRY
Hooks Cut:	NO
Housing No:	4455-N
Terminal No:	6516-4(208)
Dim C:	3.35 / .132
Plating:	208
Packaging:	PK-44646-001
Voids:	NONE

Ckts
2
3
4
5
6
7
8
9
10
11
12
13
14
15
16
17
18
19
20

Material No	Engineer Number
	A-4455-CZ02B(P909)
	A-4455-CZ 03 B(P909)
	A-4455-CZ 04 B(P909)
	A-4455-CZ 05 B(P909)
	A-4455-CZ 06 B(P909)
	A-4455-CZ 07 B(P909)
	A-4455-CZ 08 B(P909)
	A-4455-CZ 09 B(P909)
	A-4455-CZ 10 B(P909)
	A-4455-CZ 11 B(P909)
	A-4455-CZ 12 B(P909)
	A-4455-CZ 13 B(P909)
	A-4455-CZ 14 B(P909)
	A-4455-CZ 15 B(P909)
	A-4455-CZ 16 B(P909)
	A-4455-CZ 17 B(P909)
	A-4455-CZ 18 B(P909)
	A-4455-CZ 19 B(P909)
	A-4455-CZ 20 B(P909)

Material No	Engineer Number
22-18-2022	A-4455-CZ02B(565)
22-18-2032	A-4455-CZ 03 B(565)
22-18-2042	A-4455-CZ 04 B(565)
22-18-2052	A-4455-CZ 05 B(565)
22-18-2062	A-4455-CZ 06 B(565)
22-18-2072	A-4455-CZ 07 B(565)
22-18-2082	A-4455-CZ 08 B(565)
22-18-2092	A-4455-CZ 09 B(565)
22-18-2102	A-4455-CZ 10 B(565)
22-18-2112	A-4455-CZ 11 B(565)
22-18-2122	A-4455-CZ 12 B(565)
22-18-2132	A-4455-CZ 13 B(565)
22-18-2142	A-4455-CZ 14 B(565)
22-18-2152	A-4455-CZ 15 B(565)
22-18-2162	A-4455-CZ 16 B(565)
22-18-2172	A-4455-CZ 17 B(565)
22-18-2182	A-4455-CZ 18 B(565)
22-18-2192	A-4455-CZ 19 B(565)
22-18-2202	A-4455-CZ 20 B(565)

Material No	Engineer Number
	A-4455-CZ02B(208)
	A-4455-CZ 03B(208)
	A-4455-CZ 04 B(208)
	A-4455-CZ 05 B(208)
	A-4455-CZ 06 B(208)
	A-4455-CZ 07 B(208)
	A-4455-CZ 08 B(208)
	A-4455-CZ 09 B(208)
	A-4455-CZ 10 B(208)
	A-4455-CZ 11 B(208)
	A-4455-CZ 12 B(208)
	A-4455-CZ 13 B(208)
	A-4455-CZ 14 B(208)
	A-4455-CZ 15 B(208)
	A-4455-CZ 16 B(208)
	A-4455-CZ 17 B(208)
	A-4455-CZ 18 B(208)
	A-4455-CZ 19 B(208)
	A-4455-CZ 20 B(208)

REV:	<b>ECM INFORMATION:</b>	TITLE:	<h1 style="margin: 0;">KK 100 PCB ASSY</h1> <h2 style="margin: 0;">4455 SERIES DWG</h2>		SHEET No.
D15	ECM No.: 602687				- 6 -
	DATE: 22/06/2018				
DOCUMENT NUMBER:	DOC TYPE:	DOC PART:	CREATED / REVISED BY:	CHECKED BY:	APPROVED BY:
SDA-4455	PSD	002	SS06	SS06	ISHWARG



# KK 100 PCB ASSY 2-20 CKT

## 4455 SERIES

Assy Proc:	RIGHT ANGLE
Hooks Cut:	NO
Housing No:	4455-BN
Terminal No:	4316-4(228)
Dim C:	3.35 / .132
Plating:	228
Packaging:	PK-44646-002
Voids:	NONE

Assy Proc:	RIGHT ANGLE
Hooks Cut:	NO
Housing No:	4455-BN
Terminal No:	4316-4(P909)
Dim C:	3.35 / .132
Plating:	P909
Packaging:	PK-44646-002
Voids:	NONE

Ckts	Material No	Engineer Number
2		A-4455-AB02A(228)
3		A-4455-AB 03 A(228)
4		A-4455-AB 04 A(228)
5		A-4455-AB 05 A(228)
6	50-34-8518	A-4455-AB 06 A(228)
7		A-4455-AB 07 A(228)
8		A-4455-AB 08 A(228)
9		A-4455-AB 09 A(228)
10		A-4455-AB 10 A(228)
11		A-4455-AB 11 A(228)
12		A-4455-AB 12 A(228)
13		A-4455-AB 13 A(228)
14		A-4455-AB 14 A(228)
15		A-4455-AB 15 A(228)
16		A-4455-AB 16 A(228)
17		A-4455-AB 17 A(228)
18		A-4455-AB 18 A(228)
19		A-4455-AB 19 A(228)
20		A-4455-AB 20 A(228)

Material No	Engineer Number
22-15-4024	A-4455-AB02A(P909)
22-15-4034	A-4455-AB 03A(P909)
22-15-4044	A-4455-AB 04A(P909)
22-15-4054	A-4455-AB 05A(P909)
22-15-4064	A-4455-AB 06A(P909)
22-15-4074	A-4455-AB 07A(P909)
22-15-4084	A-4455-AB 08A(P909)
22-15-4094	A-4455-AB 09A(P909)
22-15-4104	A-4455-AB 10A(P909)
22-15-4114	A-4455-AB 11A(P909)
22-15-4124	A-4455-AB 12A(P909)
22-15-4134	A-4455-AB 13A(P909)
22-15-4144	A-4455-AB 14A(P909)
22-15-4154	A-4455-AB 15A(P909)
22-15-4164	A-4455-AB 16A(P909)
22-15-4174	A-4455-AB 17A(P909)
22-15-4184	A-4455-AB 18A(P909)
22-15-4194	A-4455-AB 19A(P909)
22-15-4204	A-4455-AB 20A(P909)

REV:	<b>ECM INFORMATION:</b>	<u>TITLE:</u>	<u>SHEET No.</u>		
<b>D15</b>	ECM No.: <b>602687</b>	<b>KK 100 PCB ASSY 4455 SERIES DWG</b>	<b>- 7 -</b>		
	DATE: <b>22/06/2018</b>				
<u>DOCUMENT NUMBER:</u>	<u>DOC TYPE:</u>	<u>DOC PART:</u>	<u>CREATED / REVISED BY:</u>	<u>CHECKED BY:</u>	<u>APPROVED BY:</u>
<b>SDA-4455</b>	<b>PSD</b>	<b>002</b>	<b>SS06</b>	<b>SS06</b>	<b>ISHWARG</b>



# KK 100 PCB ASSY 2-20 CKT

## 4455 SERIES

Ckts	Assy Proc: RIGHT ANGLE		Assy Proc: RIGHT ANGLE		Assy Proc: RIGHT ANGLE		Assy Proc: RIGHT ANGLE	
	Material No	Engineer Number	Material No	Engineer Number	Material No	Engineer Number	Material No	Engineer Number
	Hooks Cut:	NO	Hooks Cut:	NO	Hooks Cut:	NO	Hooks Cut:	NO
	Housing No:	4455-NR	Housing No:	4455-N	Housing No:	4455-N	Housing No:	4455-N
	Terminal No:	4316-4(P909)	Terminal No:	4316-4(228)	Terminal No:	6516-4(228)	Terminal No:	6516-4(228)
	Dim C:	3.35 / .132	Dim C:	3.35 / .132	Dim C:	3.35 / .132	Dim C:	3.35 / .132
	Plating:	P909	Plating:	228	Plating:	228	Plating:	228
	Packaging:	PK-44646-001	Packaging:	PK-44646-001	Packaging:	PK-44646-001	Packaging:	PK-44646-001
	Voids:	NONE	Voids:	NONE	Voids:	NONE	Voids:	NONE
2	22-15-4022	A-4455-AR02A(P909)		A-4455-AZ02A(228)	22-17-5023	A-4455-AZ02B(228)	22-16-2022	A-4455-AZ02B(228)
3	22-15-4032	A-4455-AR 03 A(P909)		A-4455-AZ 03 A(228)	22-17-5033	A-4455-AZ 03 B(228)	22-16-2032	A-4455-AZ 03 B(228)
4	22-15-4042	A-4455-AR 04 A(P909)		A-4455-AZ 04 A(228)	22-17-5043	A-4455-AZ 04 B(228)	22-16-2042	A-4455-AZ 04 B(228)
5	22-15-4052	A-4455-AR 05 A(P909)		A-4455-AZ 05 A(228)	22-17-5053	A-4455-AZ 05 B(228)	22-16-2052	A-4455-AZ 05 B(228)
6	22-15-4062	A-4455-AR 06 A(P909)		A-4455-AZ 06 A(228)	22-17-5063	A-4455-AZ 06 B(228)	22-16-2062	A-4455-AZ 06 B(228)
7	22-15-4072	A-4455-AR 07 A(P909)		A-4455-AZ 07 A(228)	22-17-5073	A-4455-AZ 07 B(228)	22-16-2072	A-4455-AZ 07 B(228)
8	22-15-4082	A-4455-AR 08 A(P909)		A-4455-AZ 08 A(228)	22-17-5083	A-4455-AZ 08 B(228)	22-16-2082	A-4455-AZ 08 B(228)
9	22-15-4092	A-4455-AR 09 A(P909)		A-4455-AZ 09 A(228)	22-17-5093	A-4455-AZ 09 B(228)	22-16-2092	A-4455-AZ 09 B(228)
10	22-15-4102	A-4455-AR 10 A(P909)		A-4455-AZ 10 A(228)	22-17-5103	A-4455-AZ 10 B(228)	22-16-2102	A-4455-AZ 10 B(228)
11	22-15-4112	A-4455-AR 11 A(P909)		A-4455-AZ 11 A(228)	22-17-5113	A-4455-AZ 11 B(228)	22-16-2112	A-4455-AZ 11 B(228)
12	22-15-4122	A-4455-AR 12 A(P909)		A-4455-AZ 12 A(228)	22-17-5123	A-4455-AZ 12 B(228)	22-16-2122	A-4455-AZ 12 B(228)
13	22-15-4132	A-4455-AR 13 A(P909)		A-4455-AZ 13 A(228)	22-17-5133	A-4455-AZ 13 B(228)	22-16-2132	A-4455-AZ 13 B(228)
14	22-15-4142	A-4455-AR 14 A(P909)		A-4455-AZ 14 A(228)	22-17-5143	A-4455-AZ 14 B(228)	22-16-2142	A-4455-AZ 14 B(228)
15	22-15-4152	A-4455-AR 15 A(P909)		A-4455-AZ 15 A(228)	22-17-5153	A-4455-AZ 15 B(228)	22-16-2152	A-4455-AZ 15 B(228)
16	22-15-4162	A-4455-AR 16 A(P909)		A-4455-AZ 16 A(228)	22-17-5163	A-4455-AZ 16 B(228)	22-16-2162	A-4455-AZ 16 B(228)
17	22-15-4172	A-4455-AR 17 A(P909)		A-4455-AZ 17 A(228)	22-17-5173	A-4455-AZ 17 B(228)	22-16-2172	A-4455-AZ 17 B(228)
18	22-15-4182	A-4455-AR 18 A(P909)		A-4455-AZ 18 A(228)	22-17-5183	A-4455-AZ 18 B(228)	22-16-2182	A-4455-AZ 18 B(228)
19	22-15-4192	A-4455-AR 19 A(P909)		A-4455-AZ 19 A(228)	22-17-5193	A-4455-AZ 19 B(228)	22-16-2192	A-4455-AZ 19 B(228)
20	22-15-4202	A-4455-AR 20 A(P909)	22-17-5201	A-4455-AZ 20 A(228)	22-17-5203	A-4455-AZ 20 B(228)	22-16-2202	A-4455-AZ 20 B(228)

REV:	<b>ECM INFORMATION:</b>	<u>TITLE:</u>	<b>KK 100 PCB ASSY 4455 SERIES DWG</b>	<u>SHEET No.</u>	
<b>D15</b>	ECM No.: <b>602687</b>			<b>- 8 -</b>	
	DATE: <b>22/06/2018</b>				
<u>DOCUMENT NUMBER:</u>	<u>DOC TYPE:</u>	<u>DOC PART:</u>	<u>CREATED / REVISED BY:</u>	<u>CHECKED BY:</u>	<u>APPROVED BY:</u>
<b>SDA-4455</b>	<b>PSD</b>	<b>002</b>	<b>SS06</b>	<b>SS06</b>	<b>ISHWARG</b>





# KK 100 PCB ASSY 2-20 CKT

## 4455 SERIES

	Assy Proc:	BOTTOM ENTRY	Assy Proc:	BOTTOM ENTRY	Assy Proc:	BOTTOM ENTRY	Assy Proc:	BOTTOM ENTRY
	Hooks Cut:	NO	Hooks Cut:	NO	Hooks Cut:	NO	Hooks Cut:	NO
	Housing No:	4455-N2	Housing No:	4455-N2	Housing No:	4455-N2	Housing No:	4455-N2
	Terminal No:	4316-3B(228)	Terminal No:	4316-3B(231)	Terminal No:	4316-3B(228)	Terminal No:	6516-3B(228)
	Dim C:	3.35 / .132	Dim C:	3.35 / .132	Dim C:	3.35 / .132	Dim C:	3.35 / .132
	Plating:	228	Plating:	231	Plating:	228	Plating:	228
	Packaging:	PK-44646-001	Packaging:	PK-44646-001	Packaging:	PK-44646-001	Packaging:	PK-44646-001
	Voids:	NO	Voids:	NO	Voids:	NO	Voids:	NO
Ckts	Material No	Engineer Number	Material No	Engineer Number	Material No	Engineer Number	Material No	Engineer Number
2	22-17-2024	A-4455-BH02D(228)		A-4455-BH02D(231)		A-4455-BH02D(228)	22-17-2027	A-4455-BH02J(228)
3	22-17-2034	A-4455-BH03D(228)		A-4455-BH 03 D(231)		A-4455-BH03D(228)	22-17-2037	A-4455-BH03J(228)
4	22-17-2044	A-4455-BH04D(228)		A-4455-BH 04 D(231)		A-4455-BH04D(228)	22-17-2047	A-4455-BH04J(228)
5	22-17-2054	A-4455-BH05D(228)		A-4455-BH 05 D(231)	22-17-3056	A-4455-BH05D(228)	22-17-2057	A-4455-BH05J(228)
6	22-17-2064	A-4455-BH06D(228)		A-4455-BH 06 D(231)	22-17-3066	A-4455-BH06D(228)	22-17-2067	A-4455-BH06J(228)
7	22-17-2074	A-4455-BH07D(228)		A-4455-BH 07 D(231)		A-4455-BH07D(228)	22-17-2077	A-4455-BH07J(228)
8	22-17-2084	A-4455-BH08D(228)		A-4455-BH 08 D(231)	22-17-3086	A-4455-BH08D(228)	22-17-2087	A-4455-BH08J(228)
9	22-17-2094	A-4455-BH09D(228)		A-4455-BH 09 D(231)		A-4455-BH09D(228)	22-17-2097	A-4455-BH09J(228)
10	22-17-2104	A-4455-BH10D(228)		A-4455-BH 10 D(231)		A-4455-BH10D(228)	22-17-2107	A-4455-BH10J(228)
11	22-17-2114	A-4455-BH11D(228)		A-4455-BH 11 D(231)		A-4455-BH11D(228)	22-17-2117	A-4455-BH11J(228)
12	22-17-2124	A-4455-BH12D(228)		A-4455-BH 12 D(231)		A-4455-BH12D(228)	22-17-2127	A-4455-BH12J(228)
13	22-17-2134	A-4455-BH13D(228)		A-4455-BH 13 D(231)		A-4455-BH13D(228)	22-17-2137	A-4455-BH13J(228)
14	22-17-2144	A-4455-BH14D(228)	22-17-2140	A-4455-BH 14 D(231)	22-17-3146	A-4455-BH14D(228)	22-17-2147	A-4455-BH14J(228)
15	22-17-2154	A-4455-BH15D(228)		A-4455-BH 15 D(231)		A-4455-BH15D(228)	22-17-2157	A-4455-BH15J(228)
16	22-17-2164	A-4455-BH16D(228)		A-4455-BH 16 D(231)		A-4455-BH16D(228)	22-17-2167	A-4455-BH16J(228)
17	22-17-2174	A-4455-BH17D(228)		A-4455-BH 17 D(231)		A-4455-BH17D(228)	22-17-2177	A-4455-BH17J(228)
18	22-17-2184	A-4455-BH18D(228)		A-4455-BH 18 D(231)		A-4455-BH18D(228)	22-17-2187	A-4455-BH18J(228)
19	22-17-2194	A-4455-BH19D(228)		A-4455-BH 19 D(231)	22-17-3196	A-4455-BH19D(228)	22-17-2197	A-4455-BH19J(228)
20	22-17-2204	A-4455-BH20D(228)	22-17-2200	A-4455-BH 20 D(231)	22-17-3206	A-4455-BH20D(228)	22-17-2207	A-4455-BH20J(228)

REV:	<b>ECM INFORMATION:</b>	<u>TITLE:</u>	<b>KK 100 PCB ASSY 4455 SERIES DWG</b>		<u>SHEET No.</u>
<b>D15</b>	ECM No.: <b>602687</b>				<b>- 9 -</b>
	DATE: <b>22/06/2018</b>				
<u>DOCUMENT NUMBER:</u>	<u>DOC TYPE:</u>	<u>DOC PART:</u>	<u>CREATED / REVISED BY:</u>	<u>CHECKED BY:</u>	<u>APPROVED BY:</u>
<b>SDA-4455</b>	<b>PSD</b>	<b>002</b>	<b>SS06</b>	<b>SS06</b>	<b>ISHWARG</b>



# KK 100 PCB ASSY 2-20 CKT

## 4455 SERIES

Ckts	Assy Proc: TOP ENTRY		Assy Proc: TOP ENTRY		Assy Proc: TOP ENTRY		Assy Proc: TOP ENTRY	
	Material No	Engineer Number	Material No	Engineer Number	Material No	Engineer Number	Material No	Engineer Number
2		A-4455-CP02A(208)	22-18-2026	A-4455-CY02A(565)	22-02-7023	A-4455-CY02A(P909)	22-15-4028	A-4455-CB02A(P909)
3		A-4455-CP 03 A(208)	22-18-2036	A-4455-CY 03 A(565)	22-02-7033	A-4455-CY 03A(P909)	22-15-4038	A-4455-CB 03A(P909)
4		A-4455-CP 04 A(208)	22-18-2046	A-4455-CY 04 A(565)	22-02-7043	A-4455-CY 04A(P909)	22-15-4048	A-4455-CB 04A(P909)
5	22-18-2057	A-4455-CP 05 A(208)	22-18-2056	A-4455-CY 05 A(565)	22-02-7053	A-4455-CY 05A(P909)	22-15-4058	A-4455-CB 05A(P909)
6		A-4455-CP 06 A(208)	22-18-2066	A-4455-CY 06 A(565)	22-02-7063	A-4455-CY 06A(P909)	22-15-4068	A-4455-CB 06A(P909)
7		A-4455-CP 07 A(208)	22-18-2076	A-4455-CY 07 A(565)	22-02-7073	A-4455-CY 07A(P909)	22-15-4078	A-4455-CB 07A(P909)
8		A-4455-CP 08 A(208)	22-18-2086	A-4455-CY 08 A(565)	22-02-7083	A-4455-CY 08A(P909)	22-15-4088	A-4455-CB 08A(P909)
9		A-4455-CP 09 A(208)	22-18-2096	A-4455-CY 09 A(565)	22-02-7093	A-4455-CY 09A(P909)	22-15-4098	A-4455-CB 09A(P909)
10		A-4455-CP 10 A(208)	22-18-2106	A-4455-CY 10 A(565)	22-02-7103	A-4455-CY 10A(P909)	22-15-4108	A-4455-CB 10A(P909)
11		A-4455-CP 11 A(208)	22-18-2116	A-4455-CY 11 A(565)	22-02-7113	A-4455-CY 11A(P909)	22-15-4118	A-4455-CB 11A(P909)
12		A-4455-CP 12 A(208)	22-18-2126	A-4455-CY 12 A(565)	22-02-7123	A-4455-CY 12A(P909)	22-15-4128	A-4455-CB 12A(P909)
13		A-4455-CP 13 A(208)	22-18-2136	A-4455-CY 13 A(565)	22-02-7133	A-4455-CY 13A(P909)	22-15-4138	A-4455-CB 13A(P909)
14		A-4455-CP 14 A(208)	22-18-2146	A-4455-CY 14 A(565)	22-02-7143	A-4455-CY 14A(P909)	22-15-4148	A-4455-CB 14A(P909)
15		A-4455-CP 15 A(208)	22-18-2156	A-4455-CY 15 A(565)	22-02-7153	A-4455-CY 15A(P909)	22-15-4158	A-4455-CB 15A(P909)
16		A-4455-CP 16 A(208)	22-18-2166	A-4455-CY 16 A(565)	22-02-7163	A-4455-CY 16A(P909)	22-15-4168	A-4455-CB 16A(P909)
17		A-4455-CP 17 A(208)	22-18-2176	A-4455-CY 17 A(565)	22-02-7173	A-4455-CY 17A(P909)	22-15-4178	A-4455-CB 17A(P909)
18		A-4455-CP 18 A(208)	22-18-2186	A-4455-CY 18 A(565)	22-02-7183	A-4455-CY 18A(P909)	22-15-4188	A-4455-CB 18A(P909)
19		A-4455-CP 19 A(208)	22-18-2196	A-4455-CY 19 A(565)	22-02-7193	A-4455-CY 19A(P909)	22-15-4198	A-4455-CB 19A(P909)
20		A-4455-CP 20 A(208)	22-18-2206	A-4455-CY 20 A(565)	22-02-7203	A-4455-CY 20A(P909)	22-15-4208	A-4455-CB 20A(P909)

REV:	<b>ECM INFORMATION:</b>	<u>TITLE:</u>	<b>KK 100 PCB ASSY 4455 SERIES DWG</b>	<u>SHEET No.</u>	
<b>D15</b>	ECM No.: <b>602687</b>			<b>- 10 -</b>	
	DATE: <b>22/06/2018</b>				
<u>DOCUMENT NUMBER:</u>	<u>DOC TYPE:</u>	<u>DOC PART:</u>	<u>CREATED / REVISED BY:</u>	<u>CHECKED BY:</u>	<u>APPROVED BY:</u>
<b>SDA-4455</b>	<b>PSD</b>	<b>002</b>	<b>SS06</b>	<b>SS06</b>	<b>ISHWARG</b>



# KK 100 PCB ASSY 2-20 CKT

## 4455 SERIES

Ckts	Assy Proc: TOP ENTRY		Assy Proc: TOP ENTRY		Assy Proc: TOP ENTRY		Assy Proc: TOP ENTRY	
	Material No	Engineer Number	Material No	Engineer Number	Material No	Engineer Number	Material No	Engineer Number
2	22-65-3020	A-4455-CR02A(P909)	22-18-2024	A-4455-CZ02B(228)	22-18-7023	A-4455-CY02A(208)	22-18-7021	A-4455-CY02B(228)
3	22-65-3030	A-4455-CR 03A(P909)	22-18-2034	A-4455-CZ 03 B(228)	22-18-7033	A-4455-CY 03 A(208)	22-18-7031 38-00-1478	A-4455-CY 03 B(228)
4	22-65-3040	A-4455-CR 04A(P909)	22-18-2044	A-4455-CZ 04 B(228)	22-18-7043	A-4455-CY 04 A(208)	22-18-7041	A-4455-CY 04 B(228)
5	22-65-3050	A-4455-CR 05A(P909)	22-18-2054	A-4455-CZ 05 B(228)	22-18-7053	A-4455-CY 05 A(208)	22-18-7051	A-4455-CY 05 B(228)
6	22-65-3060	A-4455-CR 06A(P909)	22-18-2064	A-4455-CZ 06 B(228)	22-18-7063	A-4455-CY 06 A(208)	22-18-7061	A-4455-CY 06 B(228)
7	22-65-3070	A-4455-CR 07A(P909)	22-18-2074	A-4455-CZ 07 B(228)	22-18-7073	A-4455-CY 07 A(208)	22-18-7071	A-4455-CY 07 B(228)
8	22-65-3080	A-4455-CR 08A(P909)	22-18-2084	A-4455-CZ 08 B(228)	22-18-7083	A-4455-CY 08 A(208)	22-18-7081	A-4455-CY 08 B(228)
9	22-65-3090	A-4455-CR 09A(P909)	22-18-2094	A-4455-CZ 09 B(228)	22-18-7093	A-4455-CY 09 A(208)	22-18-7091	A-4455-CY 09 B(228)
10	22-65-3100	A-4455-CR 10A(P909)	22-18-2104	A-4455-CZ 10 B(228)	22-18-7103	A-4455-CY 10 A(208)	22-18-7101	A-4455-CY 10 B(228)
11	22-65-3110	A-4455-CR 11A(P909)	22-18-2114	A-4455-CZ 11 B(228)	22-18-7113	A-4455-CY 11 A(208)	22-18-7111	A-4455-CY 11 B(228)
12	22-65-3120	A-4455-CR 12A(P909)	22-18-2124	A-4455-CZ 12 B(228)	22-18-7123	A-4455-CY 12 A(208)	22-18-7121	A-4455-CY 12 B(228)
13	22-65-3130	A-4455-CR 13A(P909)	22-18-2134	A-4455-CZ 13 B(228)	22-18-7133	A-4455-CY 13 A(208)	22-18-7131	A-4455-CY 13 B(228)
14	22-65-3140	A-4455-CR 14A(P909)	22-18-2144	A-4455-CZ 14 B(228)	22-18-7143	A-4455-CY 14 A(208)	22-18-7141	A-4455-CY 14 B(228)
15	22-65-3150	A-4455-CR 15A(P909)	22-18-2154	A-4455-CZ 15 B(228)	22-18-7153	A-4455-CY 15 A(208)	22-18-7151	A-4455-CY 15 B(228)
16	22-65-3160	A-4455-CR 16A(P909)	22-18-2164	A-4455-CZ 16 B(228)	22-18-7163	A-4455-CY 16 A(208)	22-18-7161	A-4455-CY 16 B(228)
17	22-65-3170	A-4455-CR 17A(P909)	22-18-2174	A-4455-CZ 17 B(228)	22-18-7173	A-4455-CY 17 A(208)	22-18-7171	A-4455-CY 17 B(228)
18	22-65-3180	A-4455-CR 18A(P909)	22-18-2184	A-4455-CZ 18 B(228)	22-18-7183	A-4455-CY 18 A(208)	22-18-7181	A-4455-CY 18 B(228)
19	22-65-3190	A-4455-CR 19A(P909)	22-18-2194	A-4455-CZ 19 B(228)	22-18-7193	A-4455-CY 19 A(208)	22-18-7191	A-4455-CY 19 B(228)
20	22-65-3200	A-4455-CR 20A(P909)	22-18-2204	A-4455-CZ 20 B(228)	22-18-7203	A-4455-CY 20 A(208)	22-18-7201	A-4455-CY 20 B(228)

REV:	<b>ECM INFORMATION:</b>	<b>TITLE:</b>	<b>SHEET No.</b>
D15	ECM No.: 602687	KK 100 PCB ASSY 4455 SERIES DWG	- 11 -
	DATE: 22/06/2018		
<b>DOCUMENT NUMBER:</b>	<b>DOC TYPE:</b>	<b>DOC PART:</b>	<b>CREATED / REVISED BY:</b>
SDA-4455	PSD	002	SS06
<b>CHECKED BY:</b>		<b>APPROVED BY:</b>	
SS06		ISHWARG	



# KK 100 PCB ASSY 2-20 CKT

## 4455 SERIES

Assy Proc:	RIGHT ANGLE
Hooks Cut:	NO
Housing No:	4455-N
Terminal No:	6516-5C(P909)
Dim C:	3.35±1.00/.132±.039
Plating:	P909
Packaging:	PK-44646-001
Voids:	NO

Assy Proc:	BOTTOM ENTRY
Hooks Cut:	NO
Housing No:	4455-N2
Terminal No:	6516-6C(P909)
Dim C:	3.61±1.00/.142±.039
Plating:	P909
Packaging:	PK-44646-001
Voids:	NO

Ckts	Material No	Engineer Number
2	38-00-1332	A-4455-AZ02C(P909)
3	38-00-1333	A-4455-AZ03C(P909)
4	38-00-1334	A-4455-AZ04C(P909)
5	38-00-1335	A-4455-AZ05C(P909)
6	38-00-1336	A-4455-AZ06C(P909)
7	38-00-1337	A-4455-AZ07C(P909)
8	38-00-1338	A-4455-AZ08C(P909)
9	38-00-1339	A-4455-AZ09C(P909)
10	38-00-1340	A-4455-AZ10C(P909)
11	38-00-1341	A-4455-AZ11C(P909)
12	38-00-1342	A-4455-AZ12C(P909)
13	38-00-1343	A-4455-AZ13C(P909)
14	38-00-1344	A-4455-AZ14C(P909)
15	38-00-1345	A-4455-AZ15C(P909)
16	38-00-1346	A-4455-AZ16C(P909)
17	38-00-1347	A-4455-AZ17C(P909)
18	38-00-1348	A-4455-AZ18C(P909)
19	38-00-1349	A-4455-AZ19C(P909)
20	38-00-1350	A-4455-AZ20C(P909)

Material No	Engineer Number
38-00-1392	A-4455-BH02F(P909)
38-00-1393	A-4455-BH03F(P909)
38-00-1394	A-4455-BH04F(P909)
38-00-1395	A-4455-BH05F(P909)
38-00-1396	A-4455-BH06F(P909)
38-00-1397	A-4455-BH07F(P909)
38-00-1398	A-4455-BH08F(P909)
38-00-1399	A-4455-BH09F(P909)
38-00-1400	A-4455-BH10F(P909)
38-00-1401	A-4455-BH11F(P909)
38-00-1402	A-4455-BH12F(P909)
38-00-1403	A-4455-BH13F(P909)
38-00-1404	A-4455-BH14F(P909)
38-00-1405	A-4455-BH15F(P909)
38-00-1406	A-4455-BH16F(P909)
38-00-1407	A-4455-BH17F(P909)
38-00-1408	A-4455-BH18F(P909)
38-00-1409	A-4455-BH19F(P909)
38-00-1410	A-4455-BH20F(P909)

<b>REV:</b>  <b>D15</b>	<b>ECM INFORMATION:</b> ECM No.: <b>602687</b> DATE: <b>22/06/2018</b>	<b>TITLE:</b>  <b>KK 100 PCB ASSY 4455 SERIES DWG</b>	<b>SHEET No.</b>  <b>- 12 -</b>		
<b>DOCUMENT NUMBER:</b> <b>SDA-4455</b>	<b>DOC TYPE:</b> <b>PSD</b>	<b>DOC PART:</b> <b>002</b>	<b>CREATED / REVISED BY:</b> <b>SS06</b>	<b>CHECKED BY:</b> <b>SS06</b>	<b>APPROVED BY:</b> <b>ISHWARG</b>



# KK 100 PCB ASSY 2-20 CKT

## 4455 SERIES

Assy Proc:	RIGHT ANGLE
Hooks Cut:	NO
Housing No:	4455-BN
Terminal No:	4316-4(565)
Dim C:	3.35 / .132
Plating:	565
Packaging:	PK-44646-002
Voids:	NO

Assy Proc:	TOP ENTRY
Hooks Cut:	NO
Housing No:	4455-N
Terminal No:	6516-5C(P909)
Dim C:	3.35±1.00/.132±.039
Plating:	P909
Packaging:	PK-44646-001
Voids:	NO

Assy Proc:	TOP ENTRY
Hooks Cut:	YES
Housing No:	4455-N-02
Terminal No:	4316-4(P909)
Dim C:	3.35 / .132
Plating:	P909
Packaging:	PK-44646-003
Voids:	YES IN CKT 2

Ckts
2
3
4
5
6
7
8
9
10
11
12
13
14
15
16
17
18
19
20

Material No	Engineer Number
22-16-3028	A-4455-AB02A(565)
22-16-3038	A-4455-AB 03 A(565)
22-16-3048	A-4455-AB 04 A(565)
22-16-3058	A-4455-AB 05 A(565)
22-16-3068	A-4455-AB 06 A(565)
22-16-3078	A-4455-AB 07 A(565)
22-16-3088	A-4455-AB 08 A(565)
22-16-3098	A-4455-AB 09 A(565)
22-16-3108	A-4455-AB 10 A(565)
22-16-3118	A-4455-AB 11 A(565)
22-16-3128	A-4455-AB 12 A(565)
22-16-3138	A-4455-AB 13 A(565)
22-16-3148	A-4455-AB 14 A(565)
22-16-3158	A-4455-AB 15 A(565)
22-16-3168	A-4455-AB 16 A(565)
22-16-3178	A-4455-AB 17 A(565)
22-16-3188	A-4455-AB 18 A(565)
22-16-3198	A-4455-AB 19 A(565)
22-16-3208	A-4455-AB 20 A(565)

Material No	Engineer Number
38-00-1422	A-4455-CZ02C(P909)
38-00-1423	A-4455-CZ03C(P909)
38-00-1424	A-4455-CZ04C(P909)
38-00-1425	A-4455-CZ05C(P909)
38-00-1426	A-4455-CZ06C(P909)
38-00-1427	A-4455-CZ07C(P909)
38-00-1428	A-4455-CZ08C(P909)
38-00-1429	A-4455-CZ09C(P909)
38-00-1430	A-4455-CZ10C(P909)
38-00-1431	A-4455-CZ11C(P909)
38-00-1432	A-4455-CZ12C(P909)
38-00-1433	A-4455-CZ13C(P909)
38-00-1434	A-4455-CZ14C(P909)
38-00-1435	A-4455-CZ15C(P909)
38-00-1436	A-4455-CZ16C(P909)
38-00-1437	A-4455-CZ17C(P909)
38-00-1438	A-4455-CZ18C(P909)
38-00-1439	A-4455-CZ19C(P909)
38-00-1440	A-4455-CZ20C(P909)

Material No	Engineer Number
22-02-3068	A-4455-CW06A(P909)-2
50-29-0004	A-4455-CW07A(P909)-2

REV:	<b>ECM INFORMATION:</b>	<u>TITLE:</u>	<b>KK 100 PCB ASSY 4455 SERIES DWG</b>	<u>SHEET No.</u>	
<b>D15</b>	ECM No.: <b>602687</b>			<b>- 13 -</b>	
	DATE: <b>22/06/2018</b>				
<u>DOCUMENT NUMBER:</u>	<u>DOC TYPE:</u>	<u>DOC PART:</u>	<u>CREATED / REVISED BY:</u>	<u>CHECKED BY:</u>	<u>APPROVED BY:</u>
<b>SDA-4455</b>	<b>PSD</b>	<b>002</b>	<b>SS06</b>	<b>SS06</b>	<b>ISHWARG</b>



# KK 100 PCB ASSY 2-20 CKT

## 4455 SERIES

Ckts	Assy Proc: TOP ENTRY		Assy Proc: TOP ENTRY		Assy Proc: BOTTOM ENTRY		Assy Proc: BOTTOM ENTRY	
	Material No	Engineer Number	Material No	Engineer Number	Material No	Engineer Number	Material No	Engineer Number
	Hooks Cut:	YES	Hooks Cut:	YES	Hooks Cut:	NO	Hooks Cut:	NO
	Housing No:	4455-N	Housing No:	4455-N	Housing No:	4455-N2	Housing No:	4455-N2
	Terminal No:	6516-4(P909)	Terminal No:	4316-4(P909)	Terminal No:	4316-3B(P909)	Terminal No:	4316-3B(208)
	Dim C:	3.35 / .132	Dim C:	3.35 / .132	Dim C:	.132 / 3.35	Dim C:	.132 / 3.35
	Plating:	P909	Plating:	P909	Plating:	P909	Plating:	208
	Packaging:	PK-44646-003	Packaging:	PK-44646-003	Packaging:	PK-44646-001	Packaging:	PK-44646-001
	Voids:	NO	Voids:	YES IN CKT 2	Voids:	YES IN CKT 10	Voids:	2,3,4,6,7,8,10,11,12
2		A-4455-CY02B(P909)						
3		A-4455-CY 03B(P909)						
4		A-4455-CY 04B(P909)						
5	50-29-1553	A-4455-CY 05B(P909)						
6	50-29-1554	A-4455-CY 06B(P909)	22-15-5065	A-4455-CY06A(P909)-2				
7		A-4455-CY 07B(P909)						
8		A-4455-CY 08B(P909)						
9		A-4455-CY 09B(P909)						
10		A-4455-CY 10B(P909)						
11		A-4455-CY 11B(P909)			50-36-1881	A-4455-BH11D(P909)-10		
12		A-4455-CY 12B(P909)						
13		A-4455-CY 13B(P909)					26-01-3099	A-4455-BH13D(208)-51
14		A-4455-CY 14B(P909)						
15		A-4455-CY 15B(P909)						
16		A-4455-CY 16B(P909)						
17		A-4455-CY 17B(P909)						
18		A-4455-CY 18B(P909)						
19		A-4455-CY 19B(P909)						
20		A-4455-CY 20B(P909)						

REV:	<b>ECM INFORMATION:</b>	<u>TITLE:</u>	<u>SHEET No.</u>
<b>D15</b>	ECM No.: <b>602687</b>	<b>KK 100 PCB ASSY 4455 SERIES DWG</b>	<b>- 14 -</b>
	DATE: <b>22/06/2018</b>		
<u>DOCUMENT NUMBER:</u>	<u>DOC TYPE:</u>	<u>DOC PART:</u>	<u>CREATED / REVISED BY:</u>
<b>SDA-4455</b>	<b>PSD</b>	<b>002</b>	<b>SS06</b>
<u>CHECKED BY:</u>		<u>APPROVED BY:</u>	
<b>SS06</b>		<b>ISHWARG</b>	



# KK 100 PCB ASSY 2-20 CKT

## 4455 SERIES

Ckts	RIGHT ANGLE		TOP ENTRY		TOP ENTRY			
	Material No	Engineer Number	Material No	Engineer Number	Material No	Engineer Number	Material No	Engineer Number
2								
3								
4								
5								
6								
7								
8								
9								
10								
11								
12								
13								
14								
15								
16								
17	46999-0582	A-4455-AB17A(P909)-51						
18								
19								
20								

<b>REV:</b>  <b>D15</b>	<b>ECM INFORMATION:</b> ECM No.: <b>602687</b> DATE: <b>22/06/2018</b>	<b>TITLE:</b>  <b>KK 100 PCB ASSY 4455 SERIES DWG</b>	<b>SHEET No.</b>  <b>- 15 -</b>		
<b>DOCUMENT NUMBER:</b> <b>SDA-4455</b>	<b>DOC TYPE:</b> <b>PSD</b>	<b>DOC PART:</b> <b>002</b>	<b>CREATED / REVISED BY:</b> <b>SS06</b>	<b>CHECKED BY:</b> <b>SS06</b>	<b>APPROVED BY:</b> <b>ISHWARG</b>

