

## STELLA-HB

~75° high bay beam for warehouse and outdoor lighting. Compatible with up to 30 mm LES size. Variant with black frame. COBs.

### SPECIFICATION:

Dimensions	Ø 90.0 mm
Height	19.5 mm
Fastening	screw
Ingress protection classes	IP67
ROHS compliant	yes ⓘ



### MATERIALS:

Component	Type	Material	Colour	Finish
STELLA-HB	Single lens	Silicone	clear	
STELLA-FRAME	Holder	PA66	black	





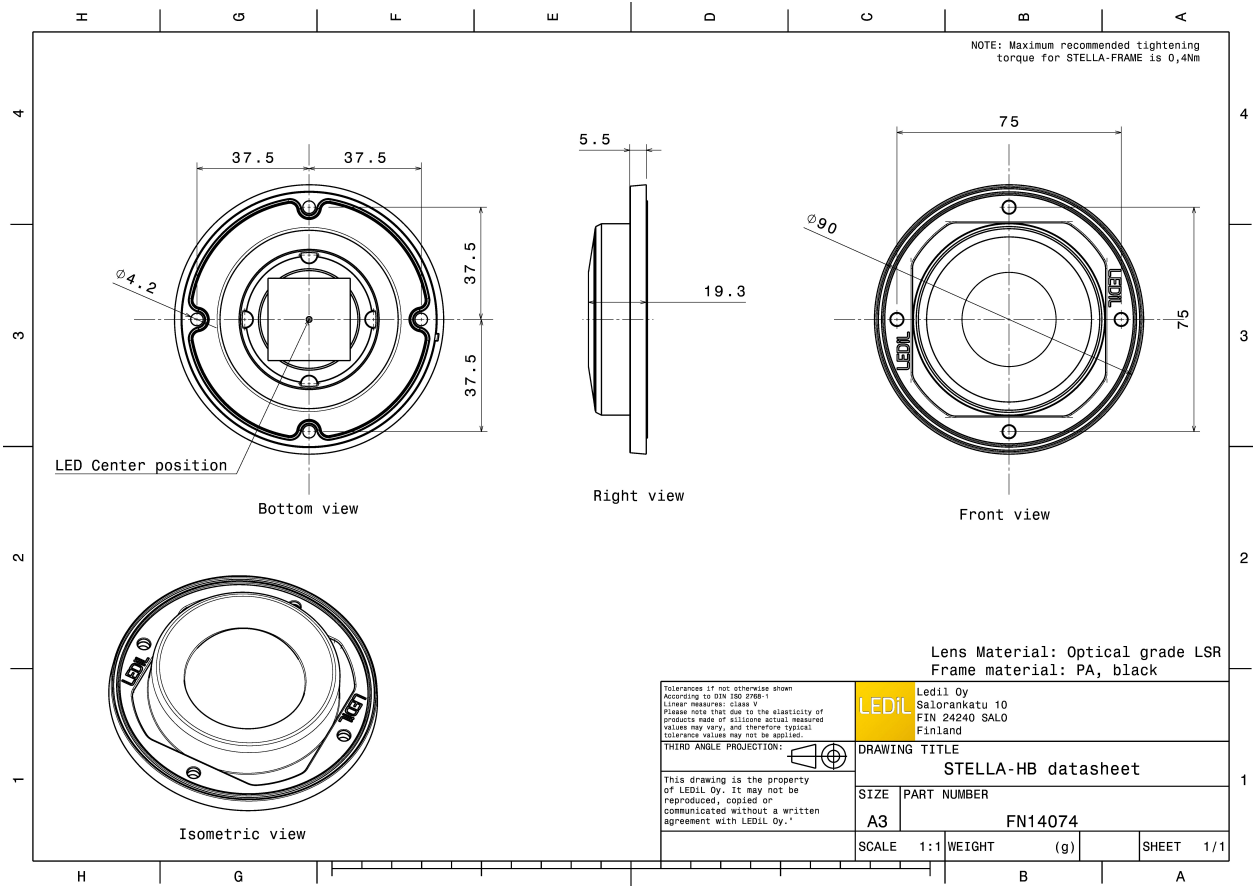

### ORDERING INFORMATION:

Component	Type	Qty in box	MOQ	MPQ	Box weight (kg)
FN14074_STELLA-HB	Single lens	135	135	15	7.9
» Box size: 480 x 280 x 300 mm					

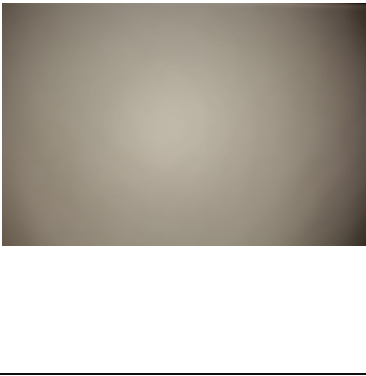
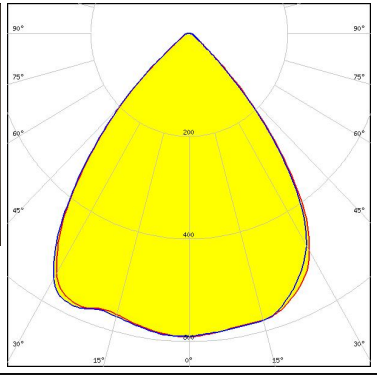

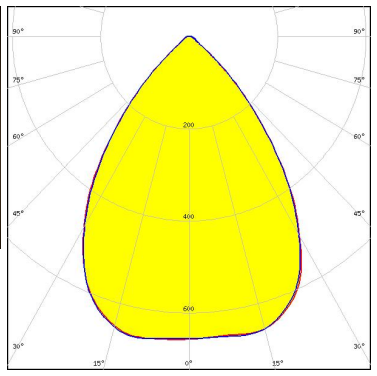
See also our general installation guide: [www.ledil.com/installation\\_guide](http://www.ledil.com/installation_guide)

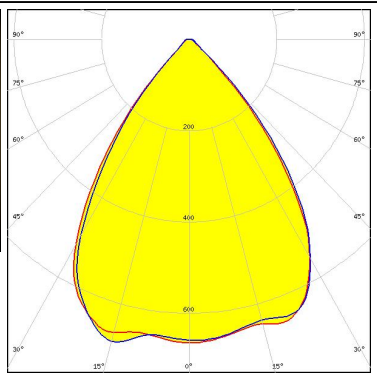
#### OPTICAL RESULTS (MEASURED):

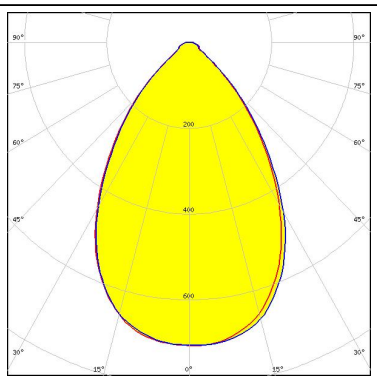
<p></p> <p>LED V18 Gen7</p> <p>FWHM / FWTM 80.0° / 101.0°</p> <p>Efficiency 93 %</p> <p>Peak intensity 0.6 cd/lm</p> <p>LEDs/each optic 1</p> <p>Light colour White</p> <p>Required components:</p>		
<p></p> <p>LED V22 Gen7</p> <p>FWHM / FWTM 75.0° / 101.0°</p> <p>Efficiency 93 %</p> <p>Peak intensity 0.7 cd/lm</p> <p>LEDs/each optic 1</p> <p>Light colour White</p> <p>Required components:</p>		
<p></p> <p>LED VERO18</p> <p>FWHM / FWTM 75.0° / 96.0°</p> <p>Efficiency 93 %</p> <p>Peak intensity 0.7 cd/lm</p> <p>LEDs/each optic 1</p> <p>Light colour White</p> <p>Required components:</p>		
<p></p> <p>LED VERO29</p> <p>FWHM / FWTM 69.0° / 104.0°</p> <p>Efficiency 94 %</p> <p>Peak intensity 0.7 cd/lm</p> <p>LEDs/each optic 1</p> <p>Light colour White</p> <p>Required components:</p>		

#### OPTICAL RESULTS (MEASURED):

#### CITIZEN

LED CLL04x/CLU04x  
 FWHM / FWTM 77.0° / 101.0°  
 Efficiency 94 %  
 Peak intensity 0.7 cd/lm  
 LEDs/each optic 1  
 Light colour White  
 Required components:

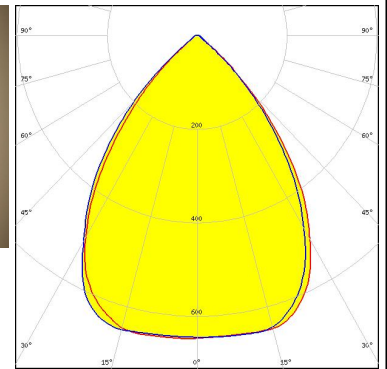
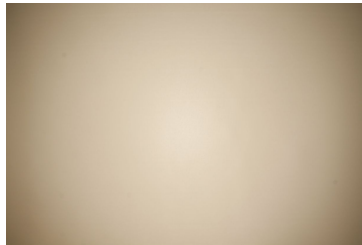

#### CITIZEN

LED CLL04x/CLU04x  
 FWHM / FWTM 68.0° / 94.0°  
 Efficiency 93 %  
 Peak intensity 0.8 cd/lm  
 LEDs/each optic 1  
 Light colour White  
 Required components:  
 Bender Wirth: 431 Typ L4

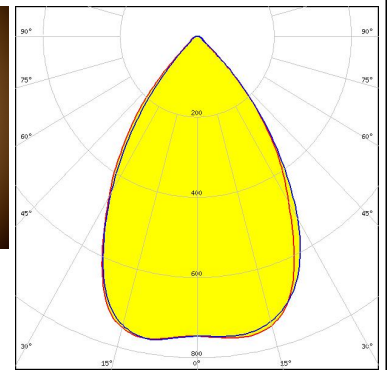
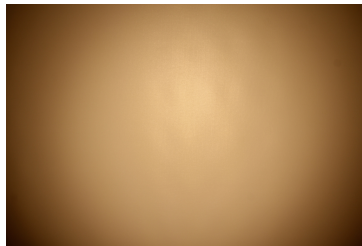

#### CITIZEN

LED CLL05x/CLU05x  
 FWHM / FWTM 73.0° / 110.0°  
 Efficiency 93 %  
 Peak intensity 0.6 cd/lm  
 LEDs/each optic 1  
 Light colour White  
 Required components:

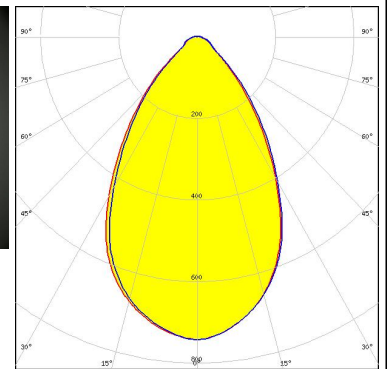
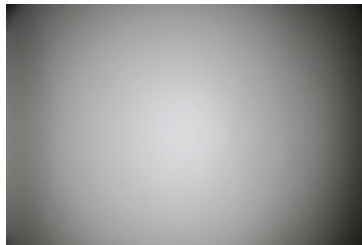

#### CITIZEN

LED CLL05x/CLU05x  
 FWHM / FWTM 65.0° / 103.0°  
 Efficiency 94 %  
 Peak intensity 0.7 cd/lm  
 LEDs/each optic 1  
 Light colour White  
 Required components:  
 Bender Wirth: 458 Typ L4

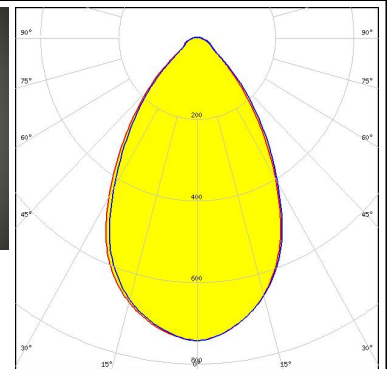
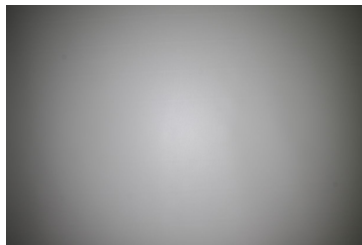

### OPTICAL RESULTS (MEASURED):

#### CREE LED

LED CMA2550  
 FWHM / FWTM 74.0° / 96.0°  
 Efficiency 94 %  
 Peak intensity 0.7 cd/m  
 LEDs/each optic 1  
 Light colour White  
 Required components:

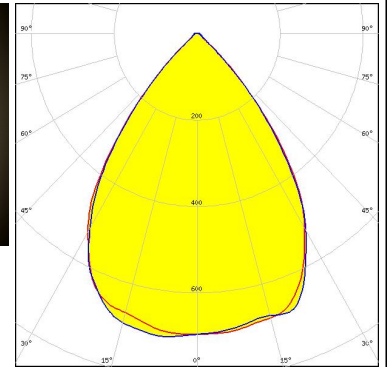
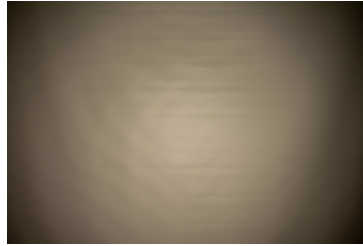

#### CREE LED

LED CMA3090  
 FWHM / FWTM 67.0° / 96.0°  
 Efficiency 96 %  
 Peak intensity 0.8 cd/m  
 LEDs/each optic 1  
 Light colour White  
 Required components:

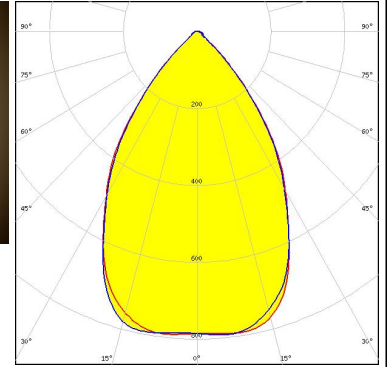
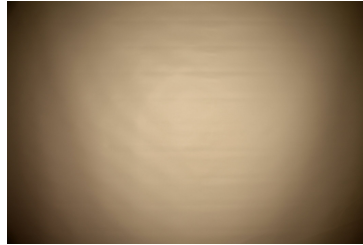

#### CREE LED

LED CXA/B 1816 & CXA/B 1820 & CXA 1850  
 FWHM / FWTM 87.0° / 104.0°  
 Efficiency 93 %  
 Peak intensity 0.6 cd/m  
 LEDs/each optic 1  
 Light colour White  
 Required components:

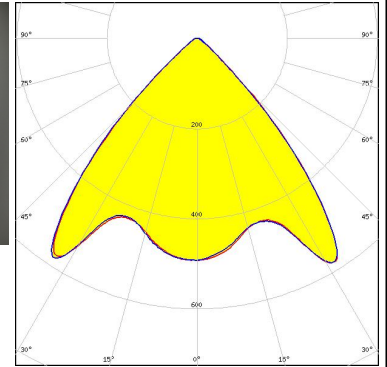

#### CREE LED

LED CXA/B 25xx  
 FWHM / FWTM 83.0° / 102.0°  
 Efficiency 93 %  
 Peak intensity 0.6 cd/m  
 LEDs/each optic 1  
 Light colour White  
 Required components:

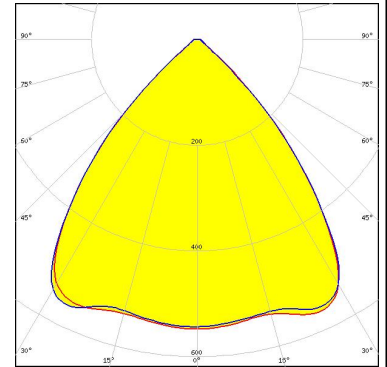

### OPTICAL RESULTS (MEASURED):

#### CREE LED

LED CXA/B 30xx  
 FWHM / FWTM 78.0° / 103.0°  
 Efficiency 93 %  
 Peak intensity 0.6 cd/lm  
 LEDs/each optic 1  
 Light colour White  
 Required components:

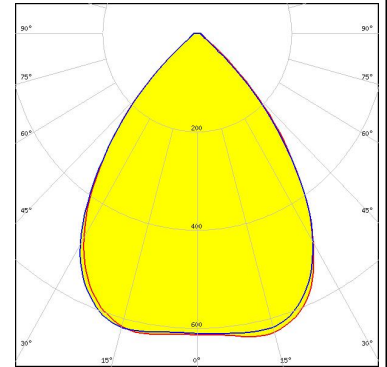

#### CREE LED

LED CXA/B 3590  
 FWHM / FWTM 72.0° / 106.0°  
 Efficiency 93 %  
 Peak intensity 0.7 cd/lm  
 LEDs/each optic 1  
 Light colour White  
 Required components:

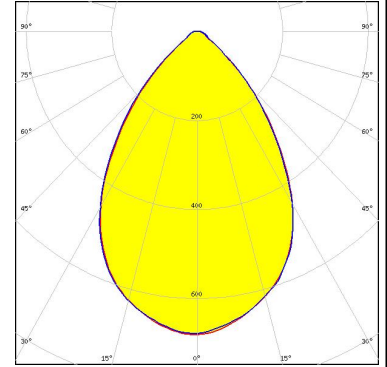

#### LUMILEDS

LED LUXEON CoB 1211  
 FWHM / FWTM 71.0° / 93.0°  
 Efficiency 93 %  
 Peak intensity 0.7 cd/lm  
 LEDs/each optic 1  
 Light colour White  
 Required components:

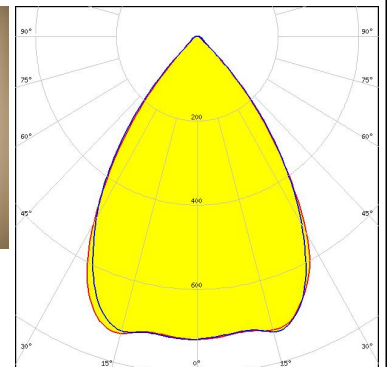
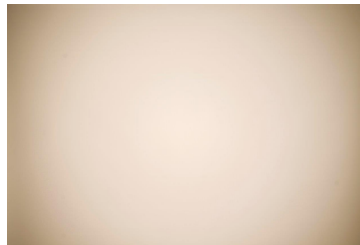

#### LUMILEDS

LED LUXEON CoB 1216/1812  
 FWHM / FWTM 72.0° / 99.0°  
 Efficiency 94 %  
 Peak intensity 0.7 cd/lm  
 LEDs/each optic 1  
 Light colour White  
 Required components:

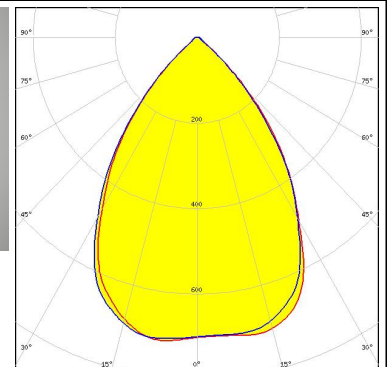

#### OPTICAL RESULTS (MEASURED):

##### LUMILEDS

LED LUXEON CoB 1321  
 FWHM / FWTM 71.0° / 108.0°  
 Efficiency 94 %  
 Peak intensity 0.7 cd/lm  
 LEDs/each optic 1  
 Light colour White  
 Required components:

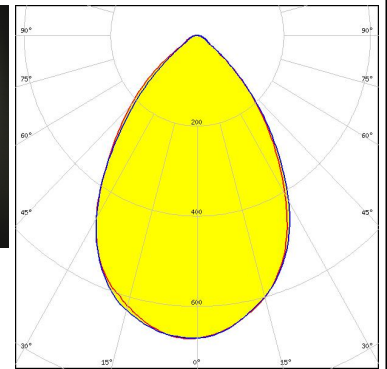
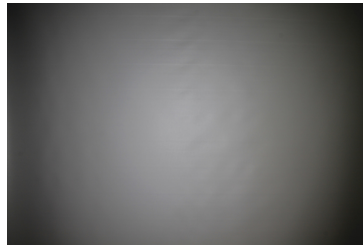

##### LUMILEDS

LED LUXEON CoB 1825  
 FWHM / FWTM 72.0° / 111.0°  
 Efficiency 93 %  
 Peak intensity 0.6 cd/lm  
 LEDs/each optic 1  
 Light colour White  
 Required components:

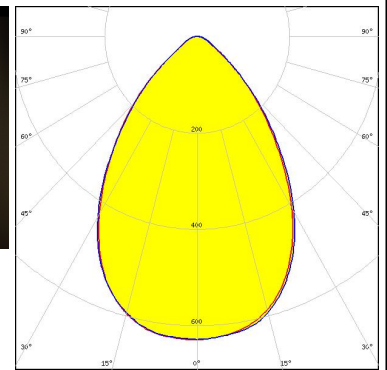

##### LUMINUS

LED CxM-18 (21.5x21.5)  
 FWHM / FWTM 80.0° / 100.0°  
 Efficiency 93 %  
 Peak intensity 0.6 cd/lm  
 LEDs/each optic 1  
 Light colour White  
 Required components:

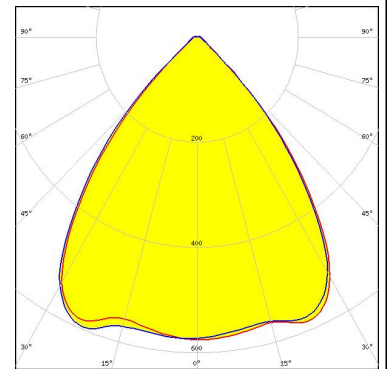

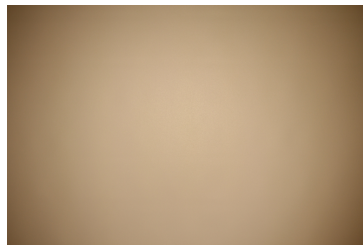

##### LUMINUS

LED CxM-22 (28x28)  
 FWHM / FWTM 73.0° / 100.0°  
 Efficiency 93 %  
 Peak intensity 0.7 cd/lm  
 LEDs/each optic 1  
 Light colour White  
 Required components:

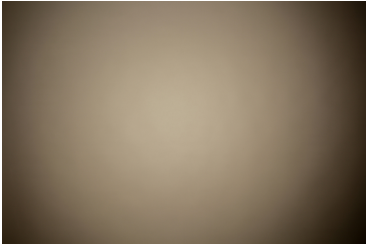
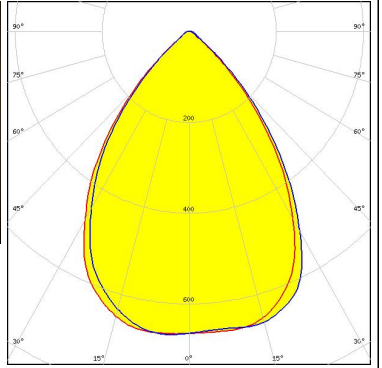
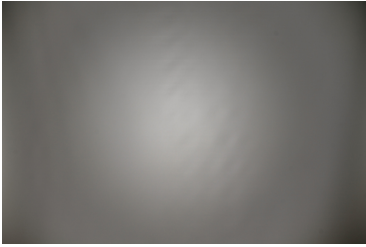
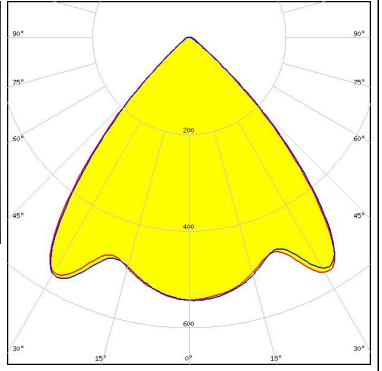

### OPTICAL RESULTS (MEASURED):

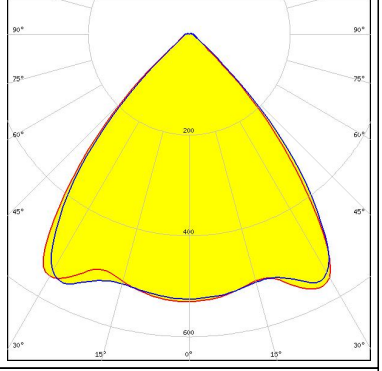
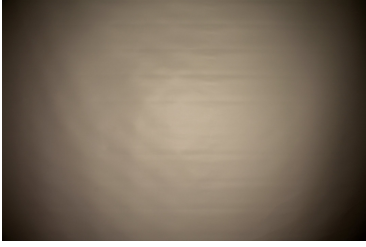
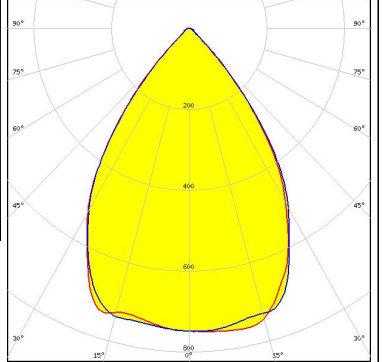
<p><b>NICHIA</b></p> <p>LED COB H-Type            FWHM / FWTM 74.0° / 102.0°            Efficiency 94 %            Peak intensity 0.7 cd/m            LEDs/each optic 1            Light colour White            Required components:</p>		
<p><b>NICHIA</b></p> <p>LED COB J-Type            FWHM / FWTM 84.0° / 102.0°            Efficiency 94 %            Peak intensity 0.6 cd/m            LEDs/each optic 1            Light colour White            Required components:</p>		
<p><b>OSRAM</b>  <small>Opto Semiconductors</small></p> <p>LED Soleriq S19            FWHM / FWTM 84.0° / 101.0°            Efficiency 92 %            Peak intensity 0.6 cd/m            LEDs/each optic 1            Light colour White            Required components:</p>		
<p><b>PHILIPS</b></p> <p>LED Fortimo SLM L19 CoB            FWHM / FWTM 71.0° / 94.0°            Efficiency 94 %            Peak intensity 0.8 cd/m            LEDs/each optic 1            Light colour White            Required components:            Bender Wirth: 431 Typ L4</p>		



#### OPTICAL RESULTS (MEASURED):

### PHILIPS

LED Fortimo SLM L23 CoB  
 FWHM / FWTM 67.0° / 96.0°  
 Efficiency 94 %  
 Peak intensity 0.8 cd/lm  
 LEDs/each optic 1  
 Light colour White  
 Required components:  
 Bender Wirth: 431 Typ L4

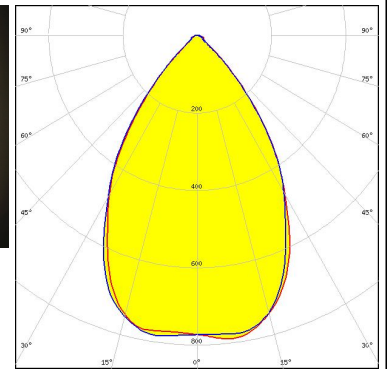

### SAMSUNG

LED LC016D / LC019D / LC026D / LC033D  
 FWHM / FWTM 83.0° / 101.0°  
 Efficiency 93 %  
 Peak intensity 0.6 cd/lm  
 LEDs/each optic 1  
 Light colour White  
 Required components:

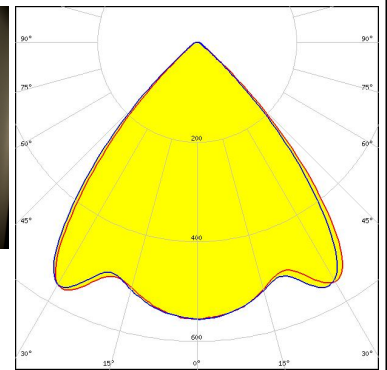
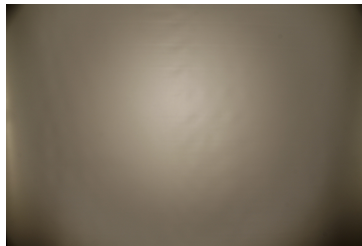

### SAMSUNG

LED LC040D / LC060D / LC080D  
 FWHM / FWTM 76.0° / 102.0°  
 Efficiency 93 %  
 Peak intensity 0.7 cd/lm  
 LEDs/each optic 1  
 Light colour White  
 Required components:

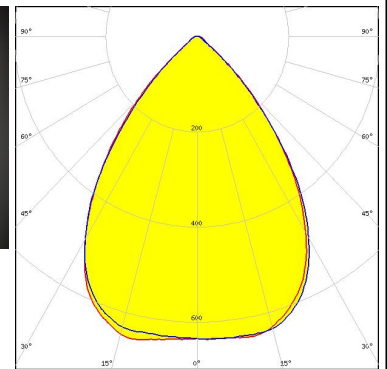
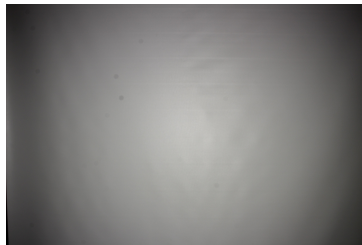

### SAMSUNG



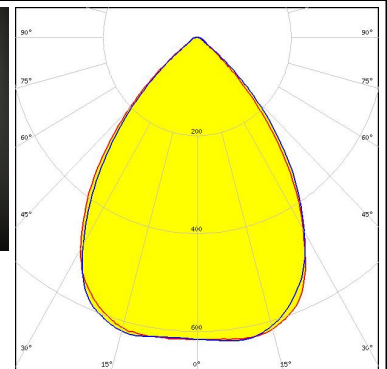
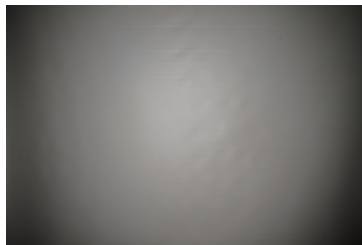

LED LC040D / LC060D / LC080D  
 FWHM / FWTM 77.0° / 104.0°  
 Efficiency 93 %  
 Peak intensity 0.6 cd/lm  
 LEDs/each optic 1  
 Light colour White  
 Required components:



### OPTICAL RESULTS (MEASURED):

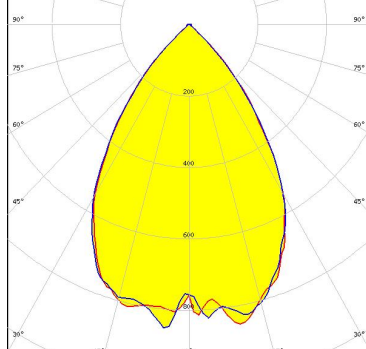
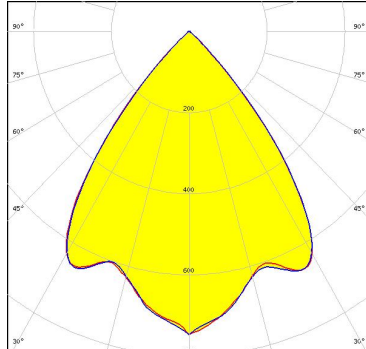

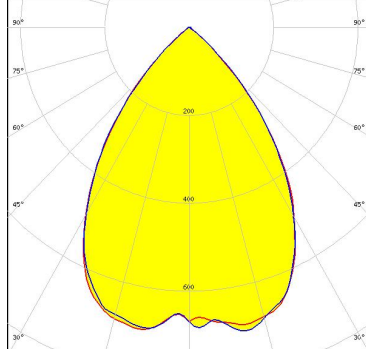
### OPTICAL RESULTS (SIMULATED):

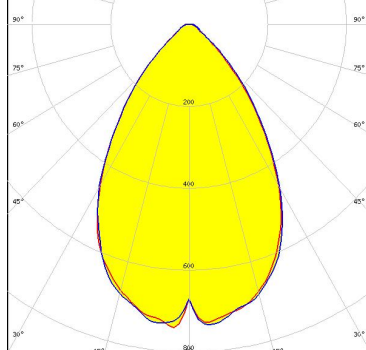
<p> LED V22 Gen7            FWHM / FWTM 68.0° / 92.0°            Efficiency 94 %            Peak intensity 0.9 cd/lm            LEDs/each optic 1            Light colour White            Required components:            Bender Wirth: 431 Typ L4</p>	
<p><b>CITIZEN</b>            LED CLL03x/CLU03x            FWHM / FWTM 76.0° / 93.0°            Efficiency 96 %            Peak intensity 0.7 cd/lm            LEDs/each optic 1            Light colour White            Required components:</p>	
<p> LED CMT28xx            FWHM / FWTM 73.0° / 98.0°            Efficiency 91 %            Peak intensity 0.7 cd/lm            LEDs/each optic 1            Light colour White            Required components:</p>	
<p> LED CXM-32            FWHM / FWTM 68.0° / 104.0°            Efficiency 96 %            Peak intensity 0.7 cd/lm            LEDs/each optic 1            Light colour White            Required components:</p>	

### GENERAL INFORMATION:

NOTE: The typical beam angle will be changed by different color, chip size and chip position tolerance. The typical total beam angle is the full angle measured where the luminous intensity is half of the peak value.

Due to use of high power COB's with this product, special attention to proper thermal design is highly recommended. LEDiL has no liability for direct, indirect or consecutive damages arising from the LEDiL products being used outside of the recommended temperature range.

### MATERIALS:

As part of our continuous research and improvement processes, and to ensure the best possible quality and availability of our products, LEDiL reserves the right to change material grades without notice.

### PRODUCT DATA USER AGREEMENT AND DISCLAIMER:

The measured data in the provided downloadable LEDiL Product Datasheets and Mechanical 2D-Drawings is rounded and provided as reference for planning. LEDiL Oy's optical specifications have been verified by conducting performance testing of the products in accordance with the company's quality system. The reported data are averaged results of multiple measurements with typical variation. LEDiL Oy reserves the right to without prior notification make changes and improvements to its products.

LEDiL Oy assumes neither warranty, nor guarantee nor any other liability of any kind for the contents and correctness of the provided data. The provided data has been generated with highest diligence but the provided data may in reality not represent the complete possible variation range of all intrinsic parameters. Therefore, in certain cases a deviation from the provided data could occur.

LEDiL Oy reserves the right to undertake technical changes of its products without further notification which could lead to changes in the provided data. LEDiL Oy assumes no liability of any kind for the possible deviation from any provided data or any other damage resulting from the usage of the provided data.

The user agrees to this disclaimer and user agreement with the download or usage of the provided files.

#### LEDiL Oy

Joensuunkatu 13  
FI-24240 SALO  
Finland

#### LEDiL Inc.

228 West Page Street  
Suite D  
Sycamore IL 60178  
USA

#### Ledil Optics Technology (Shenzhen) Co., Ltd.

# 405 , Block B  
Casic Motor Building  
Shenzhen 518057  
P.R.CHINA

#### Local sales and technical support

[www.ledil.com/  
where\\_to\\_buy](http://www.ledil.com/where_to_buy)

#### Shipping locations

Salo, Finland  
Hong Kong, China

#### Distribution Partners

[www.ledil.com/  
where\\_to\\_buy](http://www.ledil.com/where_to_buy)