



Is Now Part of



ON Semiconductor®

To learn more about ON Semiconductor, please visit our website at
www.onsemi.com

ON Semiconductor and the ON Semiconductor logo are trademarks of Semiconductor Components Industries, LLC dba ON Semiconductor or its subsidiaries in the United States and/or other countries. ON Semiconductor owns the rights to a number of patents, trademarks, copyrights, trade secrets, and other intellectual property. A listing of ON Semiconductor's product/patent coverage may be accessed at www.onsemi.com/site/pdf/Patent-Marking.pdf. ON Semiconductor reserves the right to make changes without further notice to any products herein. ON Semiconductor makes no warranty, representation or guarantee regarding the suitability of its products for any particular purpose, nor does ON Semiconductor assume any liability arising out of the application or use of any product or circuit, and specifically disclaims any and all liability, including without limitation special, consequential or incidental damages. Buyer is responsible for its products and applications using ON Semiconductor products, including compliance with all laws, regulations and safety requirements or standards, regardless of any support or applications information provided by ON Semiconductor. "Typical" parameters which may be provided in ON Semiconductor data sheets and/or specifications can and do vary in different applications and actual performance may vary over time. All operating parameters, including "Typicals" must be validated for each customer application by customer's technical experts. ON Semiconductor does not convey any license under its patent rights nor the rights of others. ON Semiconductor products are not designed, intended, or authorized for use as a critical component in life support systems or any FDA Class 3 medical devices or medical devices with a same or similar classification in a foreign jurisdiction or any devices intended for implantation in the human body. Should Buyer purchase or use ON Semiconductor products for any such unintended or unauthorized application, Buyer shall indemnify and hold ON Semiconductor and its officers, employees, subsidiaries, affiliates, and distributors harmless against all claims, costs, damages, and expenses, and reasonable attorney fees arising out of, directly or indirectly, any claim of personal injury or death associated with such unintended or unauthorized use, even if such claim alleges that ON Semiconductor was negligent regarding the design or manufacture of the part. ON Semiconductor is an Equal Opportunity/Affirmative Action Employer. This literature is subject to all applicable copyright laws and is not for resale in any manner.



FDMS7650DC

N-Channel Dual Cool™ 56 PowerTrench® MOSFET 30 V, 100 A, 0.99 mΩ

Features

- Dual Cool™ Top Side Cooling PQFN package
- Max $r_{DS(on)}$ = 0.99 mΩ at $V_{GS} = 10\text{ V}$, $I_D = 36\text{ A}$
- Max $r_{DS(on)}$ = 1.55 mΩ at $V_{GS} = 4.5\text{ V}$, $I_D = 32\text{ A}$
- High performance technology for extremely low $r_{DS(on)}$
- RoHS Compliant

General Description

This N-Channel MOSFET is produced using Fairchild Semiconductor's advanced PowerTrench® process. Advancements in both silicon and Dual Cool™ package technologies have been combined to offer the lowest $r_{DS(on)}$ while maintaining excellent switching performance by extremely low Junction-to-Ambient thermal resistance.

Applications

- Synchronous Rectifier for DC/DC Converters
- Telecom Secondary Side Rectification
- High End Server/Workstation

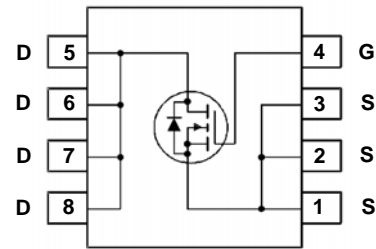
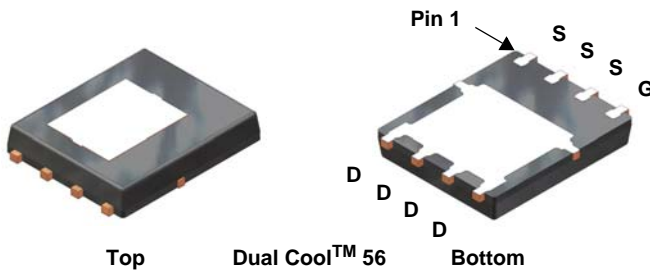

MOSFET Maximum Ratings $T_A = 25\text{ °C}$ unless otherwise noted

Symbol	Parameter	Ratings	Units
V_{DS}	Drain to Source Voltage	30	V
V_{GS}	Gate to Source Voltage (Note 4)	±20	V
I_D	Drain Current -Continuous (Package limited) $T_C = 25\text{ °C}$	100	A
	-Continuous (Silicon limited) $T_C = 25\text{ °C}$	289	
	-Continuous $T_A = 25\text{ °C}$ (Note 1a)	47	
	-Pulsed	200	
E_{AS}	Single Pulse Avalanche Energy (Note 3)	578	mJ
dv/dt	Peak Diode Recovery dv/dt (Note 5)	0.5	V/ns
P_D	Power Dissipation $T_C = 25\text{ °C}$	125	W
	Power Dissipation $T_A = 25\text{ °C}$ (Note 1a)	3.3	
T_J, T_{STG}	Operating and Storage Junction Temperature Range	-55 to +150	°C

Thermal Characteristics

$R_{\theta JC}$	Thermal Resistance, Junction to Case (Top Source)	2.3	°C/W
$R_{\theta JC}$	Thermal Resistance, Junction to Case (Bottom Drain)	1	
$R_{\theta JA}$	Thermal Resistance, Junction to Ambient (Note 1a)	38	
$R_{\theta JA}$	Thermal Resistance, Junction to Ambient (Note 1b)	81	
$R_{\theta JA}$	Thermal Resistance, Junction to Ambient (Note 1i)	16	
$R_{\theta JA}$	Thermal Resistance, Junction to Ambient (Note 1j)	23	
$R_{\theta JA}$	Thermal Resistance, Junction to Ambient (Note 1k)	11	

Package Marking and Ordering Information

Device Marking	Device	Package	Reel Size	Tape Width	Quantity
7650	FDMS7650DC	Dual Cool™ 56	13 "	12 mm	3000 units

FDMS7650DC N-Channel Dual Cool™ 56 PowerTrench® MOSFET

Electrical Characteristics $T_J = 25\text{ }^\circ\text{C}$ unless otherwise noted

Symbol	Parameter	Test Conditions	Min	Typ	Max	Units
--------	-----------	-----------------	-----	-----	-----	-------

Off Characteristics

BV_{DSS}	Drain to Source Breakdown Voltage	$I_D = 250\text{ }\mu\text{A}$, $V_{GS} = 0\text{ V}$	30			V
$\frac{\Delta BV_{DSS}}{\Delta T_J}$	Breakdown Voltage Temperature Coefficient	$I_D = 250\text{ }\mu\text{A}$, referenced to $25\text{ }^\circ\text{C}$		12		mV/°C
I_{DSS}	Zero Gate Voltage Drain Current	$V_{DS} = 24\text{ V}$, $V_{GS} = 0\text{ V}$			1	μA
I_{GSS}	Gate to Source Leakage Current, Forward	$V_{GS} = 20\text{ V}$, $V_{DS} = 0\text{ V}$			100	nA

On Characteristics

$V_{GS(th)}$	Gate to Source Threshold Voltage	$V_{GS} = V_{DS}$, $I_D = 250\text{ }\mu\text{A}$	1.1	1.9	2.7	V
$\frac{\Delta V_{GS(th)}}{\Delta T_J}$	Gate to Source Threshold Voltage Temperature Coefficient	$I_D = 250\text{ }\mu\text{A}$, referenced to $25\text{ }^\circ\text{C}$		-7		mV/°C
$r_{DS(on)}$	Static Drain to Source On Resistance	$V_{GS} = 10\text{ V}$, $I_D = 36\text{ A}$		0.6	0.99	m Ω
		$V_{GS} = 4.5\text{ V}$, $I_D = 32\text{ A}$		1	1.55	
		$V_{GS} = 10\text{ V}$, $I_D = 36\text{ A}$, $T_J = 125\text{ }^\circ\text{C}$		0.9	1.5	
g_{FS}	Forward Transconductance	$V_{DS} = 5\text{ V}$, $I_D = 36\text{ A}$		225		S

Dynamic Characteristics

C_{iss}	Input Capacitance	$V_{DS} = 15\text{ V}$, $V_{GS} = 0\text{ V}$, $f = 1\text{ MHz}$		11100	14765	pF
C_{oss}	Output Capacitance			3440	4575	pF
C_{rss}	Reverse Transfer Capacitance			205	310	pF
R_g	Gate Resistance			1.3		Ω

Switching Characteristics

$t_{d(on)}$	Turn-On Delay Time	$V_{DD} = 15\text{ V}$, $I_D = 36\text{ A}$, $V_{GS} = 10\text{ V}$, $R_{GEN} = 6\text{ }\Omega$		29	46	ns	
t_r	Rise Time			28	45	ns	
$t_{d(off)}$	Turn-Off Delay Time			81	130	ns	
t_f	Fall Time			20	32	ns	
Q_g	Total Gate Charge		$V_{GS} = 0\text{ V to }10\text{ V}$		147	206	nC
Q_g	Total Gate Charge		$V_{GS} = 0\text{ V to }4.5\text{ V}$		62	87	nC
Q_{gs}	Gate to Source Charge	$V_{DD} = 15\text{ V}$, $I_D = 36\text{ A}$		38		nC	
Q_{gd}	Gate to Drain "Miller" Charge			9.7		nC	

Drain-Source Diode Characteristics

V_{SD}	Source to Drain Diode Forward Voltage	$V_{GS} = 0\text{ V}$, $I_S = 2.1\text{ A}$ (Note 2)		0.7	1.2	V
		$V_{GS} = 0\text{ V}$, $I_S = 36\text{ A}$ (Note 2)		0.8	1.3	
t_{rr}	Reverse Recovery Time	$I_F = 36\text{ A}$, $di/dt = 100\text{ A}/\mu\text{s}$		75	120	ns
Q_{rr}	Reverse Recovery Charge			61	98	nC

Thermal Characteristics

$R_{\theta JC}$	Thermal Resistance, Junction to Case (Top Source)	2.3	$^{\circ}\text{C}/\text{W}$
$R_{\theta JC}$	Thermal Resistance, Junction to Case (Bottom Drain)	1	
$R_{\theta JA}$	Thermal Resistance, Junction to Ambient (Note 1a)	38	
$R_{\theta JA}$	Thermal Resistance, Junction to Ambient (Note 1b)	81	
$R_{\theta JA}$	Thermal Resistance, Junction to Ambient (Note 1c)	27	
$R_{\theta JA}$	Thermal Resistance, Junction to Ambient (Note 1d)	34	
$R_{\theta JA}$	Thermal Resistance, Junction to Ambient (Note 1e)	16	
$R_{\theta JA}$	Thermal Resistance, Junction to Ambient (Note 1f)	19	
$R_{\theta JA}$	Thermal Resistance, Junction to Ambient (Note 1g)	26	
$R_{\theta JA}$	Thermal Resistance, Junction to Ambient (Note 1h)	61	
$R_{\theta JA}$	Thermal Resistance, Junction to Ambient (Note 1i)	16	
$R_{\theta JA}$	Thermal Resistance, Junction to Ambient (Note 1j)	23	
$R_{\theta JA}$	Thermal Resistance, Junction to Ambient (Note 1k)	11	
$R_{\theta JA}$	Thermal Resistance, Junction to Ambient (Note 1l)	13	

NOTES:

1. $R_{\theta JA}$ is determined with the device mounted on a FR-4 board using a specified pad of 2 oz copper as shown below. $R_{\theta JC}$ is guaranteed by design while $R_{\theta CA}$ is determined by the user's board design.

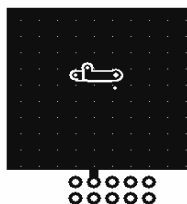

a. 38 $^{\circ}\text{C}/\text{W}$ when mounted on a 1 in² pad of 2 oz copper

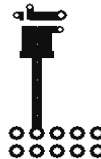

b. 81 $^{\circ}\text{C}/\text{W}$ when mounted on a minimum pad of 2 oz copper

- c. Still air, 20.9x10.4x12.7mm Aluminum Heat Sink, 1 in² pad of 2 oz copper
- d. Still air, 20.9x10.4x12.7mm Aluminum Heat Sink, minimum pad of 2 oz copper
- e. Still air, 45.2x41.4x11.7mm Aavid Thermalloy Part # 10-L41B-11 Heat Sink, 1 in² pad of 2 oz copper
- f. Still air, 45.2x41.4x11.7mm Aavid Thermalloy Part # 10-L41B-11 Heat Sink, minimum pad of 2 oz copper
- g. 200FPM Airflow, No Heat Sink, 1 in² pad of 2 oz copper
- h. 200FPM Airflow, No Heat Sink, minimum pad of 2 oz copper
- i. 200FPM Airflow, 20.9x10.4x12.7mm Aluminum Heat Sink, 1 in² pad of 2 oz copper
- j. 200FPM Airflow, 20.9x10.4x12.7mm Aluminum Heat Sink, minimum pad of 2 oz copper
- k. 200FPM Airflow, 45.2x41.4x11.7mm Aavid Thermalloy Part # 10-L41B-11 Heat Sink, 1 in² pad of 2 oz copper
- l. 200FPM Airflow, 45.2x41.4x11.7mm Aavid Thermalloy Part # 10-L41B-11 Heat Sink, minimum pad of 2 oz copper

2. Pulse Test: Pulse Width < 300 μs , Duty cycle < 2.0%.

3. E_{AS} of 578 mJ is based on starting $T_J = 25^{\circ}\text{C}$; N-ch: $L = 1 \text{ mH}$, $I_{AS} = 34 \text{ A}$, $V_{DD} = 27 \text{ V}$, $V_{GS} = 10 \text{ V}$.

4. As an N-ch device, the negative Vgs rating is for low duty cycle pulse occurrence only. No continuous rating is implied.

5. $I_{SD} \leq 36 \text{ A}$, $di/dt \leq 100 \text{ A}/\mu\text{s}$, $V_{DD} \leq BV_{DSS}$, Starting $T_J = 25^{\circ}\text{C}$.

Typical Characteristics $T_J = 25\text{ }^\circ\text{C}$ unless otherwise noted

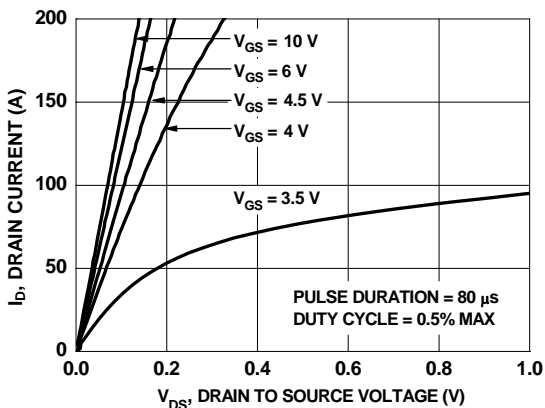

Figure 1. On Region Characteristics

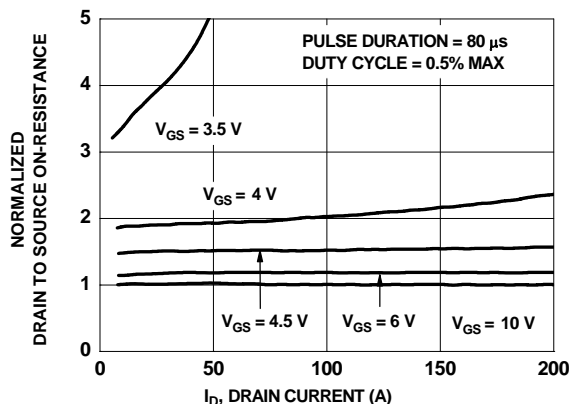

Figure 2. Normalized On-Resistance vs Drain Current and Gate Voltage

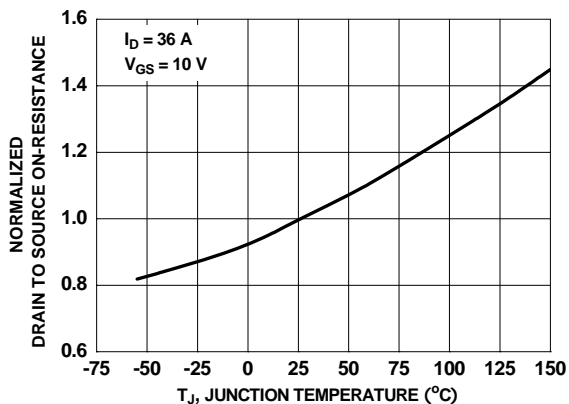

Figure 3. Normalized On Resistance vs Junction Temperature

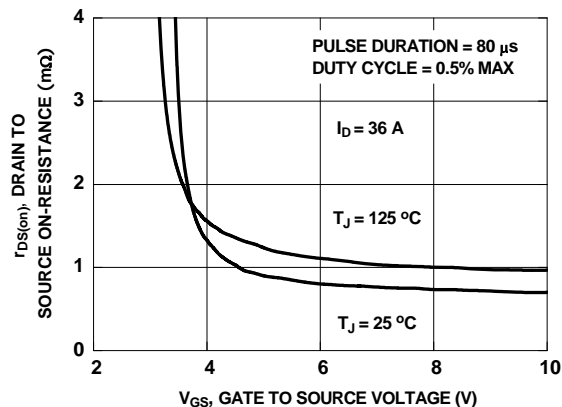

Figure 4. On-Resistance vs Gate to Source Voltage

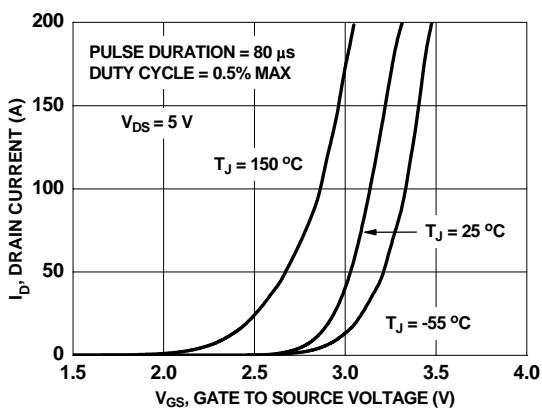

Figure 5. Transfer Characteristics

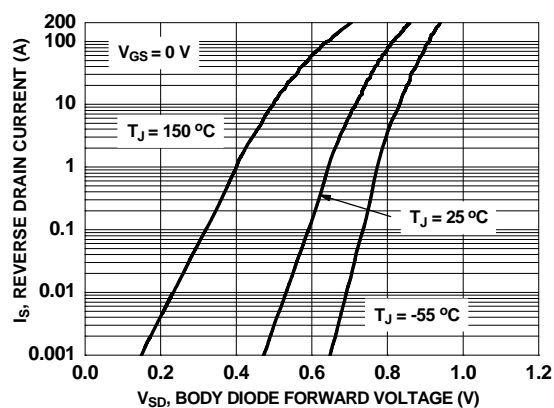

Figure 6. Source to Drain Diode Forward Voltage vs Source Current

Typical Characteristics $T_J = 25^\circ\text{C}$ unless otherwise noted

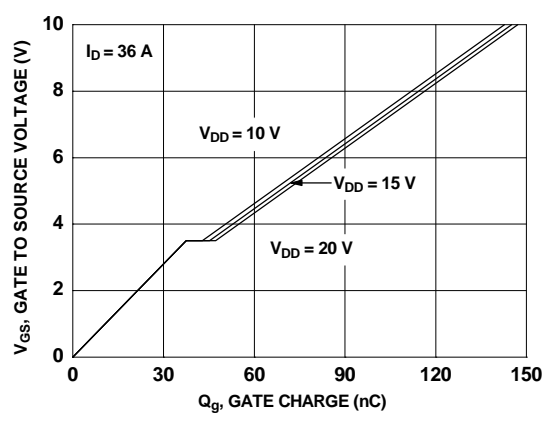

Figure 7. Gate Charge Characteristics

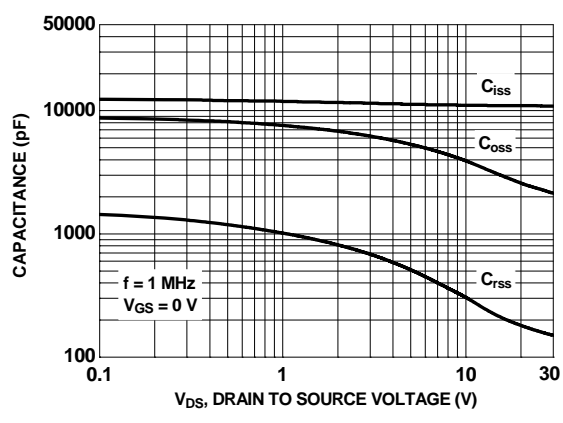

Figure 8. Capacitance vs Drain to Source Voltage

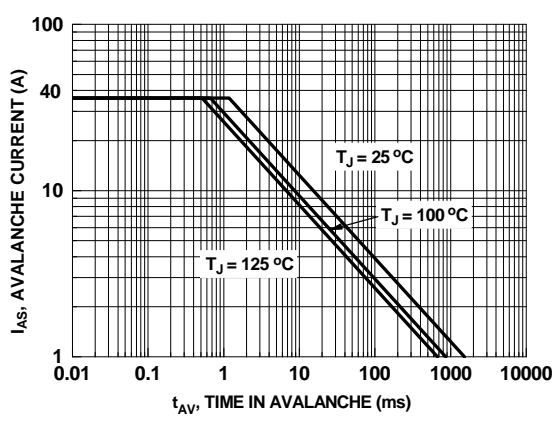

Figure 9. Unclamped Inductive Switching Capability

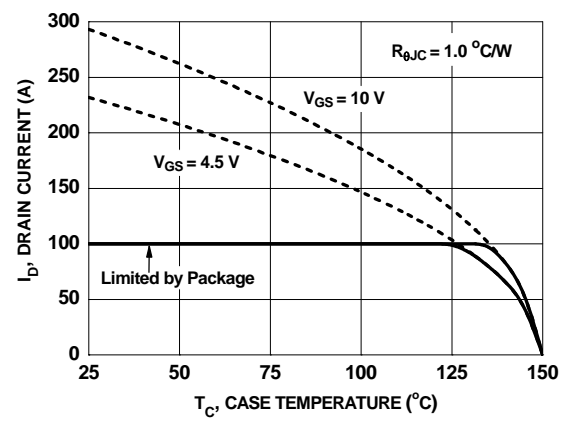

Figure 10. Maximum Continuous Drain Current vs Case Temperature

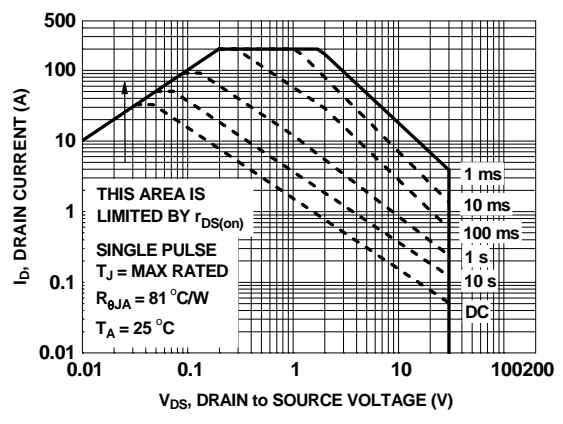

Figure 11. Forward Bias Safe Operating Area

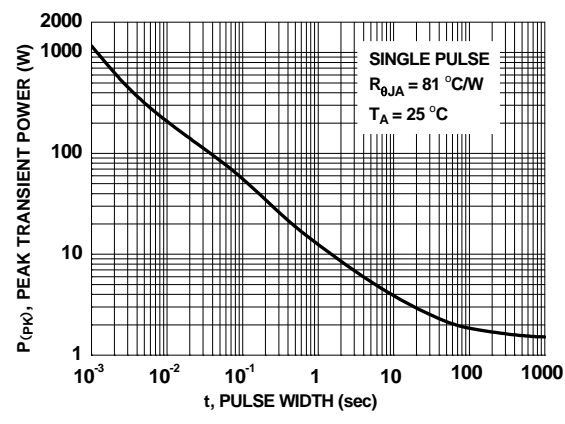

Figure 12. Single Pulse Maximum Power Dissipation

Typical Characteristics $T_J = 25\text{ }^\circ\text{C}$ unless otherwise noted

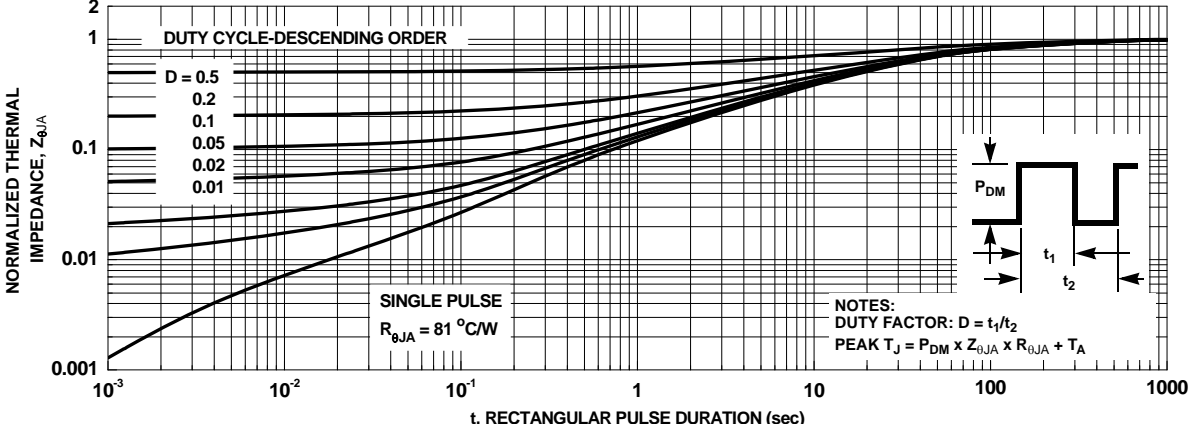
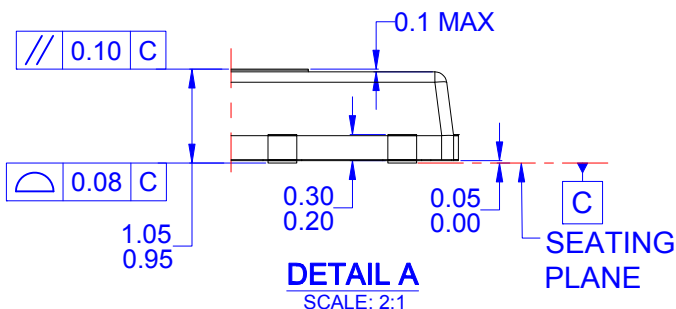
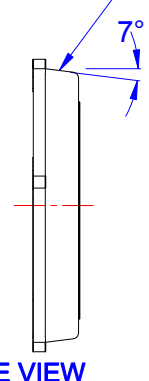
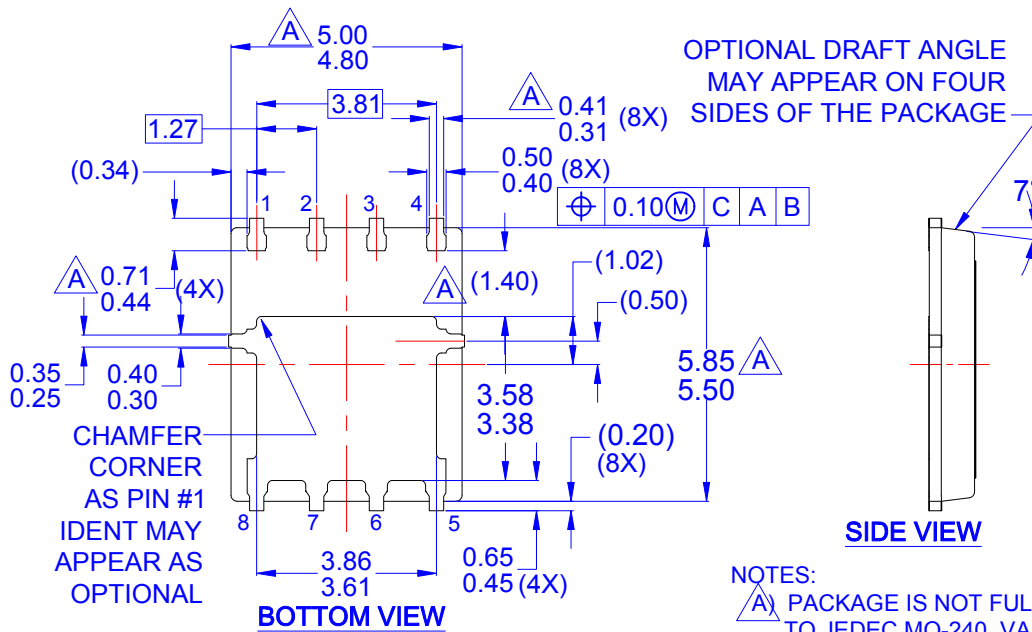
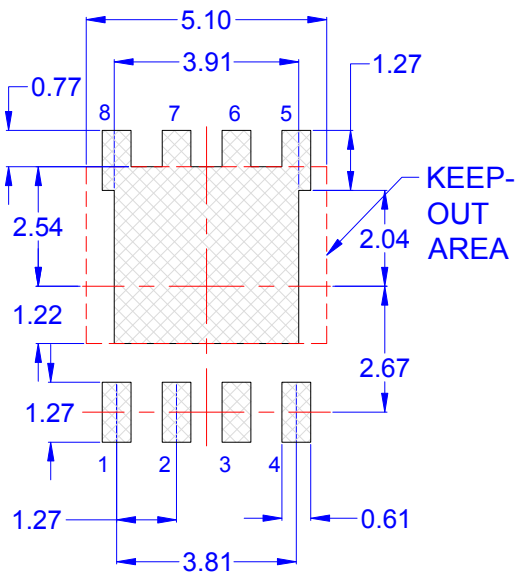
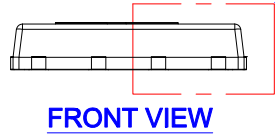
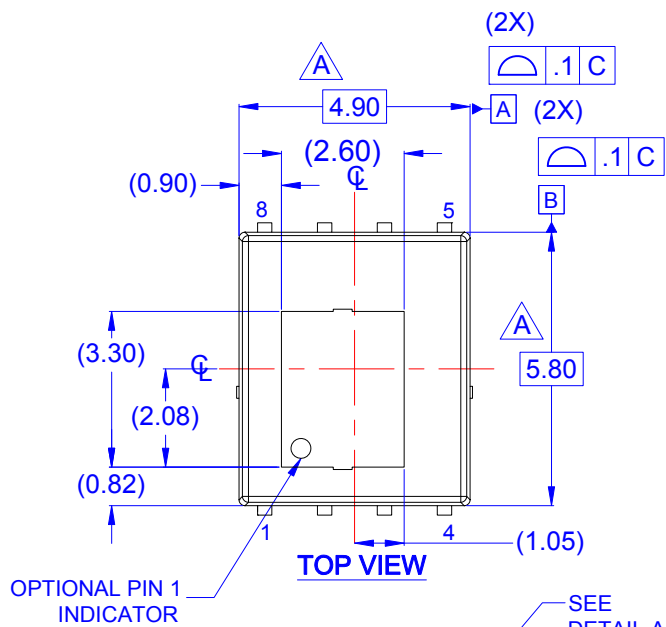

Figure 13. Junction-to-Ambient Transient Thermal Response Curve



- NOTES:**
- A) PACKAGE IS NOT FULLY COMPLIANT TO JEDEC MO-240, VARIATION AA.
 - B) ALL DIMENSIONS ARE IN MILLIMETERS.
 - C) DIMENSIONS DO NOT INCLUDE BURRS OR MOLD FLASH. MOLD FLASH OR BURRS DOES NOT EXCEED 0.10MM.
 - D) DIMENSIONING AND TOLERANCING PER ASME Y14.5M-2009.
 - E) IT IS RECOMMENDED TO HAVE NO TRACES OR VIAS WITHIN THE KEEP OUT AREA.
 - F) DRAWING FILE NAME: PQFN08DREV4



ON Semiconductor and  are trademarks of Semiconductor Components Industries, LLC dba ON Semiconductor or its subsidiaries in the United States and/or other countries. ON Semiconductor owns the rights to a number of patents, trademarks, copyrights, trade secrets, and other intellectual property. A listing of ON Semiconductor's product/patent coverage may be accessed at www.onsemi.com/site/pdf/Patent-Marking.pdf. ON Semiconductor reserves the right to make changes without further notice to any products herein. ON Semiconductor makes no warranty, representation or guarantee regarding the suitability of its products for any particular purpose, nor does ON Semiconductor assume any liability arising out of the application or use of any product or circuit, and specifically disclaims any and all liability, including without limitation special, consequential or incidental damages. Buyer is responsible for its products and applications using ON Semiconductor products, including compliance with all laws, regulations and safety requirements or standards, regardless of any support or applications information provided by ON Semiconductor. "Typical" parameters which may be provided in ON Semiconductor data sheets and/or specifications can and do vary in different applications and actual performance may vary over time. All operating parameters, including "Typicals" must be validated for each customer application by customer's technical experts. ON Semiconductor does not convey any license under its patent rights nor the rights of others. ON Semiconductor products are not designed, intended, or authorized for use as a critical component in life support systems or any FDA Class 3 medical devices or medical devices with a same or similar classification in a foreign jurisdiction or any devices intended for implantation in the human body. Should Buyer purchase or use ON Semiconductor products for any such unintended or unauthorized application, Buyer shall indemnify and hold ON Semiconductor and its officers, employees, subsidiaries, affiliates, and distributors harmless against all claims, costs, damages, and expenses, and reasonable attorney fees arising out of, directly or indirectly, any claim of personal injury or death associated with such unintended or unauthorized use, even if such claim alleges that ON Semiconductor was negligent regarding the design or manufacture of the part. ON Semiconductor is an Equal Opportunity/Affirmative Action Employer. This literature is subject to all applicable copyright laws and is not for resale in any manner.

PUBLICATION ORDERING INFORMATION

LITERATURE FULFILLMENT:

Literature Distribution Center for ON Semiconductor
19521 E. 32nd Pkwy, Aurora, Colorado 80011 USA
Phone: 303-675-2175 or 800-344-3860 Toll Free USA/Canada
Fax: 303-675-2176 or 800-344-3867 Toll Free USA/Canada
Email: orderlit@onsemi.com

N. American Technical Support: 800-282-9855 Toll Free
USA/Canada
Europe, Middle East and Africa Technical Support:
Phone: 421 33 790 2910
Japan Customer Focus Center
Phone: 81-3-5817-1050

ON Semiconductor Website: www.onsemi.com
Order Literature: <http://www.onsemi.com/orderlit>
For additional information, please contact your local
Sales Representative