

DESCRIPTION: COAXIAL / SIGNAL - SOLDER CUP - MALE

**SPECIFICATIONS:**

**ELECTRICAL:**

INSULATOR RESISTANCE: 5,000 MegOHMS Min.  
 DIELECTRIC WITHSTANDING: 1,000VAC r.m.s.  
 OPERATING TEMPERATURE: -55° C ~ +125° C  
 CONTACT RESISTANCE: 30 MilliOHMS Max.  
 COAXIAL PINS: 50 OHM  
 SIGNAL PINS: 3 AMPS

**MECHANICAL:**

CONTACT INSERTION FORCE: 4.5 Kg Max.  
 CONTACT SEPARATOR FORCE: 0.3Kg Min.

**MATERIALS:**

CONTACTS: BRASS  
 INSULATOR: PBT UL94V-0 RATED,  
 230°C PROCESS TEMP.  
 STEEL  
 SHELL:  
 FINISH:  
 SHELL: NICKEL

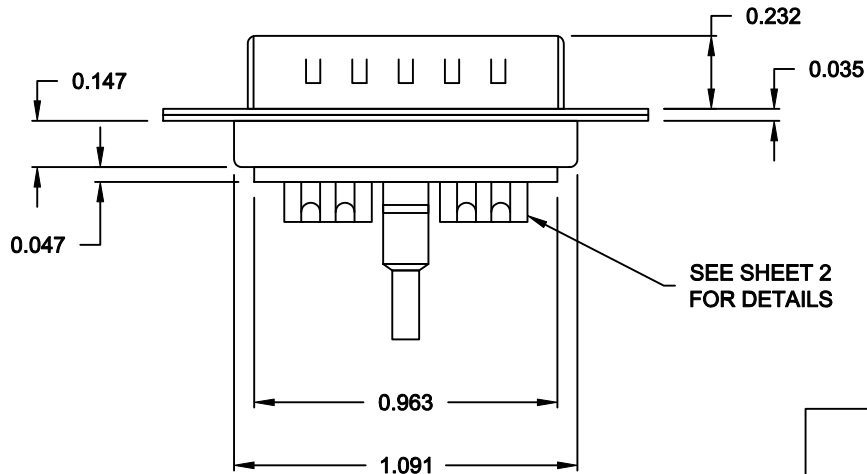
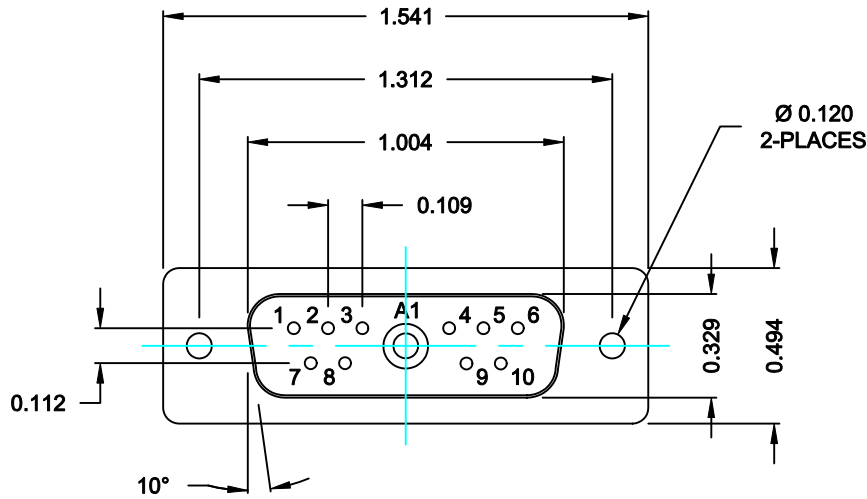

68211W1103L001

00 = 50 OHM COAXIAL

RoHS COMPLIANT

	THESE DRAWINGS AND SPECIFICATIONS ARE THE PROPERTY OF NorComp AND SHALL NOT BE REPRODUCED, COPIED OR USED AS THE BASIS FOR THE MANUFACTURE OF SALE OF APPARATUS WITHOUT WRITTEN PERMISSION.		DRAWN: <b>C. SMITH</b>	DATE: <b>09-21-06</b>
			CHECKED: <b>X</b>	DATE: <b>X</b>
<h1>NorComp</h1>		SCALE: <b>N.T.S.</b>	SHEET <b>1</b> OF <b>2</b>	REV <b>2</b>
		DWG NO. <b>68211W1103L001</b>		

**NOTE:**  
 SIGNAL CONTACTS COME PRE-LOADED INTO INSULATORS.  
 COAXIAL CONTACTS SUPPLIED - NOT PRE-LOADED.

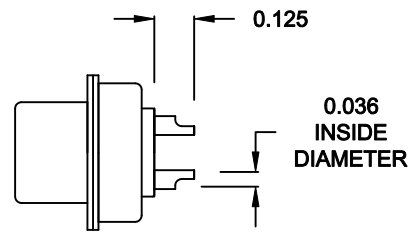

**SIGNAL CONTACTS**  
 ACCEPTS UP TO 20 AWG WIRE

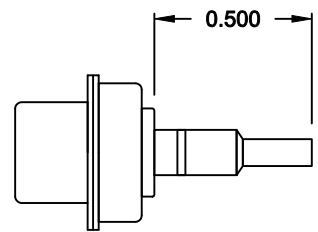

**COAXIAL CONTACT**  
 ACCEPTS 50 OHM COAX, RG316/RG174

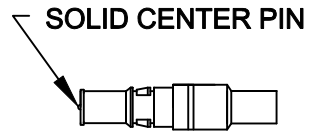

**FEMALE COAXIAL CONTACT**

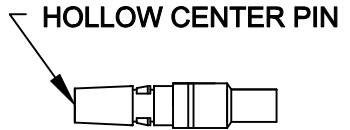

**MALE COAXIAL CONTACT**

**RoHS COMPLIANT**

	THESE DRAWINGS AND SPECIFICATIONS ARE THE PROPERTY OF NorComp AND SHALL NOT BE REPRODUCED, COPIED OR USED AS THE BASIS FOR THE MANUFACTURE OF SALE OF APPARATUS WITHOUT WRITTEN PERMISSION.		DRAWN: <b>C. SMITH</b>	DATE: <b>09-21-06</b>
			CHECKED: <b>X</b>	DATE: <b>X</b>
<h1>NorComp</h1>		SCALE: <b>N.T.S.</b>	SHEET <b>2</b> OF <b>2</b>	REV <b>2</b>
		DWG NO. <b>68211W1103L001</b>		