



ON Semiconductor

Universal Input, 20 W, LED Ballast

| Device | Application | Input Voltage | Output Power | Topology | I/O Isolation |
|---------|----------------------|---------------|--------------|----------|---------------|
| NCP1351 | Solid State Lighting | 85 – 265 Vac | 20 W | Flyback | Yes |

Other Specifications

| | Output 1 | | | |
|------------------------|-----------|--|--|--|
| Maximum Output Voltage | 33 V | | | |
| Ripple | Not Given | | | |
| Nominal Current | 700 mA | | | |

| | |
|-----------------------------------|---------------------|
| PFC (Yes/No) | No |
| Target Efficiency | 80% at nominal load |
| Max Size | 125 x 37 x 35 mm |
| Operating Temp Range | 0 to +70°C |
| Cooling Method/Supply Orientation | Convection |
| Signal Level Control | No |

| | |
|--------------------|--|
| Other Requirements | |
|--------------------|--|

Circuit Description

The NCP1351 controller provides for a low cost, variable frequency, flyback converter. It incorporates a very low quiescent current allowing for high value resistors to be used as a start-up circuit direct from the HV rail.

The design comprises an input filter, bridge rectifier (using low cost 1N4007 diodes), bulk capacitors and line inductor in π -filter arrangement, the power stage, rectifier diode and smoothing capacitors. Feedback is CVCC, constant current drive for the LED's with a constant voltage in the event of an open circuit output.

In order to stay below IEC6100-3-2 Class C, the design has been optimized at <25 W, so assuming 80% efficiency the maximum output power is ~20 W.

Key Features

- Wide input voltage range – 85 Vac to 265 Vac
- Small size, and low cost
- Good line regulation
- High efficiency
- Overload and short circuit protection.

| Number of LED's in series | LED Current | | | |
|---------------------------|-------------|--------|--------|--------|
| | 350 mA | 700 mA | 1 A | 1.5 A |
| LUXEON® I | 11 | | Note 1 | |
| LUXEON® III | 10 | 6 | 4 | Note 1 |
| LUXEON® Rebel | 10 | 6 | 4 | Note 1 |
| LUXEON® K2 | 11 | 6 | 4 | 2 |
| Cree XR-E® | 12 | 8 | 5 | Note 1 |
| Cree XP-E® | 12 | 8 | Note 1 | Note 1 |
| OSRAM Platinum Dragon® | 12 | 7 | 5 | Note 1 |
| V _Z (D10) | 45 V | 33 V | 22 V | 12 V |
| R12 & R13 | 3R6 | 1R8 | 1R2 | 0R8 |

Note 1 Out of LED specification

DN06040/D Schematic

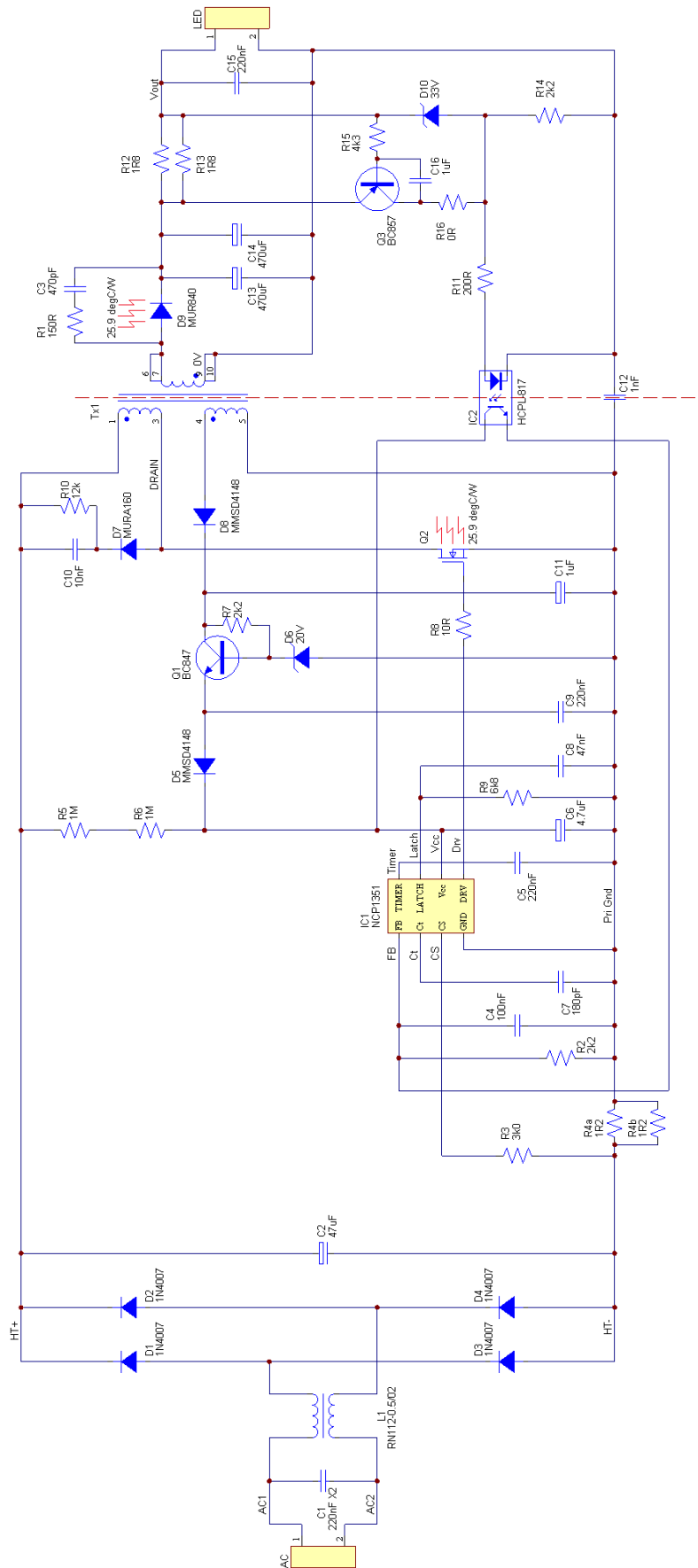

LED Current

The light output of an LED is determined by the forward current so the control loop will be constant current, with a simple Zener to limit the maximum output voltage.

Typical forward voltages vary by LED supplier, below are the nominal forward voltage characteristics of the LUXEON® K2 at different operating currents.

| I _F | V _F |
|----------------|----------------|
| 350 mA | 3.42 V |
| 700 mA | 3.60 V |
| 1000 mA | 3.72 V |
| 1500 mA | 3.85 V |

Driving eight LED's at 700mA thus gives an output power of 20.2 W at 28.8 V.

Inductor selection

In a flyback converter the inductance required in the transformer primary is dependant on the mode of operation and the output power. Discontinuous operation requires lower inductance but results in higher peak to average current waveforms, and thus higher losses. For low power designs, such as this ballast, the inductance is designed to be just continuous (or just discontinuous) under worst case conditions, that is minimum line and maximum load.

The specification for this ballast is as follows:

- Universal input – 85 Vac to 265 Vac
- 25 W maximum input power – PFC limit
- Assuming 80% efficiency – 20 W output power
- 700 mA output current
- 100 kHz operation at full load

This gives us a minimum DC input voltage of 120 V, there will be some sag on the DC bulk capacitors so an allowance will be made for this by using 80 V as the minimum input voltage, including MOSFET drop etc.

First we need to calculate the turn's ratio, this is set by the MOSFET drain rating, line voltage and reflected secondary voltage. Since this is a constant current circuit we are designing, with a varying output voltage, we need the maximum output voltage.

- V_{IN(max)} is the maximum rectified input = 375 V.
- V_{IN(min)} is the minimum rectified input = 80 V.
- V_{OUT} is 35 V (20 W @ 700 mA is 29 V plus a margin for safety).

With a 600 V MOSFET and derating of 80%, our maximum allowable drain voltage is:

$$V_{D(max)} = 600 \times 0.8 = 480 \text{ V} \dots\dots\dots(\text{Eq.3})$$

And thus headroom, V_{CLAMP} for the reflected secondary voltage and leakage spike of:

$$V_{CLAMP} = V_{D(max)} - V_{IN(max)} = 480 - 375 \dots\dots\dots(\text{Eq.4})$$

$$= 105 \text{ V}$$

The output current is sensed by a series resistance, once the voltage drop across this reaches the base-emitter threshold of the PNP transistor current flows in the opto-coupler diode and thus in the FB pin of the NCP1351.

The LED current is thus set by:

$$I_{LED} = \frac{0.6V}{R_{SENSE}} \dots\dots\dots(\text{Eq.1})$$

Total sense resistor power dissipation is:

$$P_D = I_{LED} \times 0.6V \dots\dots\dots(\text{Eq.2})$$

So for 700 mA we need a 0.9 Ω sense resistor capable of dissipating 420 mW, two 330 mW surface mount resistors, 1.8 Ω each in parallel, are used.

Good results are obtained if we set V_{CLAMP}, at ~150% of the reflected secondary:

$$k_C = \frac{V_{CLAMP} \times N}{(V_{OUT} + V_f)} = 1.5 \dots\dots\dots(\text{Eq.5})$$

- V_f = 0.7 V as we will need a high voltage diode.

Re-arranging for N:

$$N = \frac{N_s}{N_p} = \frac{1.5 \times (35 + 0.7)}{105} \dots\dots\dots(\text{Eq.6})$$

$$= 0.51$$

We will use a ratio of 0.5 or 2:1, this will give a good transformer construction.

We can now calculate the maximum duty cycle running in CCM:

$$\delta_{MAX} = \frac{V_{OUT}}{V_{OUT} + V_{IN(min)}N} = \frac{(35 + 0.7)}{(35 + 0.7) + 80 \times 0.5} \dots\dots\dots(\text{Eq.7})$$

$$= 0.47$$

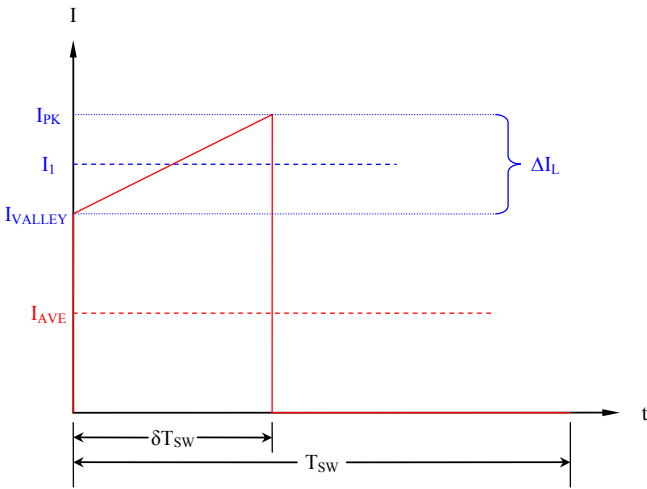

Looking at the waveform of the current flowing in the primary of the inductor (above) if we define a term k equal to;

$$k = \frac{\Delta I_L}{I_1} \dots\dots\dots(\text{Eq.8})$$

And use the equation:

$$L = \frac{(V_{IN(\min)} \delta_{MAX})^2}{f_{SW} k P_{IN}} \dots\dots\dots(\text{Eq.9})$$

Then we can determine the inductance we require.

If $k = 2$ then we are in boundary conduction mode as the ripple current equals twice the average pulse current, so setting k to 2:

$$L = \frac{(80 \times 0.47)^2}{100 \times 10^3 \times 2.0 \times 25} = 283 \mu H \dots\dots\dots(\text{Eq.10})$$

Thus we can now find the primary ripple current assuming operation in boundary conduction mode:

$$\begin{aligned} \Delta I_L &= \frac{V_{IN(\min)} T_{ON}}{L} = \frac{V_{IN(\min)} \delta_{max}}{L f_{SW}} \dots\dots\dots(\text{Eq.11}) \\ &= \frac{80 \times 0.47}{283 \times 10^{-6} \times 100 \times 10^3} = 1.32 \text{ A} \end{aligned}$$

The average input current, I_{AVE} , is:

$$I_{AVE} = \frac{P_{IN}}{V_{IN(\min)}} = \frac{25}{80} = 313 \text{ mA} \dots\dots\dots(\text{Eq.12})$$

The average pulse current, I_1 , is:

$$I_1 = \frac{I_{AVE}}{\delta_{max}} = \frac{0.313}{0.47} = 662 \text{ mA} \dots\dots\dots(\text{Eq.13})$$

Demonstrating that ΔI_L does equal twice I_1 and that the peak primary current is 1.32 A.

We can calculate the RMS current in the MOSFET and sense resistor for dissipation purposes. For a stepped-sawtooth waveform of this type the equation is:

$$I_{RMS} = I_1 \sqrt{\delta} \sqrt{1 + \frac{1}{3} \left(\frac{\Delta I_L}{2 I_1} \right)^2} \dots\dots\dots(\text{Eq.14})$$

Thus:

$$\begin{aligned} I_{RMS} &= 0.665 \times \sqrt{0.47} \times \sqrt{1 + \frac{1}{3} \left(\frac{1.32}{2 \times 0.665} \right)^2} \\ &= 526 \text{ mA} \end{aligned} \dots\dots\dots(\text{Eq.15})$$

We can also determine the current sense resistor, allowing for a drop across the resistor of 0.8 V:

$$R_{SENSE} = \frac{V_{DROP}}{I_{PK}} = \frac{0.8}{1.32} = 0.61 \Omega \dots\dots\dots(\text{Eq.16})$$

The total power dissipation is:

$$\begin{aligned} P_{D(sense)} &= I_{RMS}^2 R_{SENSE} = 0.526^2 \times 0.61 \\ &\cong 170 \text{ mW} \end{aligned} \dots\dots\dots(\text{Eq.17})$$

Two 1.2 Ω resistors in parallel will be used as sub 1 Ω resistors typically cost more.

The threshold voltage for the current sense is set by an offset resistor; this has a bias current of 270 μA in it so we can determine the resistor value:

$$R_{OFFSET} = \frac{V_{SENSE}}{I_{BIAS}} = \frac{0.8}{270 \times 10^{-6}} \cong 3.0 \text{ k}\Omega \dots\dots\dots(\text{Eq.18})$$

Rectifier snubber

Testing demonstrated the need for snubbing on the rectifier as there was a large amount of ringing present after the rectifier turns off.

The snubber consists of a resistor and capacitor in series, and knowing the junction capacitance and ringing frequency we can determine the necessary values:

$$R_s = \sqrt{\frac{L}{C_j}} \dots\dots\dots(\text{Eq.19})$$

$$C_s = \frac{2\pi\sqrt{LC_j}}{R_s} \dots\dots\dots(\text{Eq.20})$$

Knowing that:

$$f = \frac{1}{2\pi\sqrt{LC_j}} \dots\dots\dots(\text{Eq.21})$$

We can determine L , the stray inductance which then allows us to calculate the necessary snubber resistor.

- $f = 14.5$ MHz (measured on oscilloscope)
- $C_j = 80$ pF (datasheet figure for MUR840 at 62 V)

$$L = \frac{1}{4C_j(\pi f)^2} = \frac{1}{4 \times 80 \times 10^{-12} \times (\pi \times 14.5 \times 10^6)^2}$$

$$= 1.51 \mu\text{H}$$

.....(Eq.22)

$$R_s = \sqrt{\frac{1.51 \times 10^{-6}}{80 \times 10^{-12}}} = 137 \Omega \dots\dots\dots(\text{Eq.23})$$

$$C_s = \frac{2 \times \pi \times \sqrt{1.51 \times 10^{-6} \times 80 \times 10^{-12}}}{137} = 504 \text{ pF}$$

.....(Eq.24)

The nearest standard values are 470 pF and 140 Ω , inserting these into the circuit eliminated the ringing due to the rectifier.

Auxiliary winding

Normally in a flyback converter the auxiliary winding would be in the form of a flyback winding, i.e. in phase with the output winding, and thus provide a semi-regulated voltage to supply the controller. As this ballast is current controlled and the output voltage can vary over a considerable range depending on the number of LED's connected, a forward phased winding is used. The auxiliary will therefore vary with line rather than output voltage. Since neither option could supply sufficient volts at low input/output voltage whilst still staying below the maximum V_{CC} figure of 28 V, a voltage regulator is used formed by Q1 and D6. Below ~20 V the regulator does nothing other than act as a small volt drop, however as the voltage rises it clamps the voltage to around 20.7 V, since the current is very low into the V_{CC} pin there is very little loss.

DN06040/D MAGNETICS DESIGN DATA SHEET

Project / Customer: ON Semiconductor
 Part Description: 25 W Transformer
 Schematic ID: -
 Core Type: EE25
 Core Gap: Gap for 250 μ H
 Inductance: 250 μ H
 Bobbin Type: NIC 10-pin vertical

Windings (in order):

| Winding # / type | Turns / Material / Gauge / Insulation Data |
|-------------------|---|
| N1, Primary | Start on pin 1 and wind 20 turns, of 0.28 mm triple insulated wire (e.g. Tex-E), in one neat layer across the entire bobbin width. Finish on pin 2. |
| N2, Secondary | Start on pins 9&10 and wind 20 turns, of 0.8 mm Grade II ECW, distributed evenly across the entire bobbin width. Finish on pins 6&7. |
| N3, Primary | Start on pin 2 and wind 20 turns, of 0.28 mm triple insulated wire (e.g. Tex-E), in one neat layer across the entire bobbin width. Finish on pin 3. |
| N4, Primary (Aux) | Start on pin 4 and wind 5 turns, of 0.28 mm triple insulated wire, in one neat layer spread evenly across the entire bobbin width. Finish on pin 5. |

Sleeving and insulation between primary and secondary as required to meet the requirements of double insulation.

Primary leakage inductance (pins 6&7 and 9&10 shorted together) to be < 6 μ H

NIC part number: NLT282224W3P4020S5P10F

Hipot: 3 kV between pins 1, 2, 3, 4 & 5 and pins 6, 7, 8, 9 & 10 for 60 seconds.

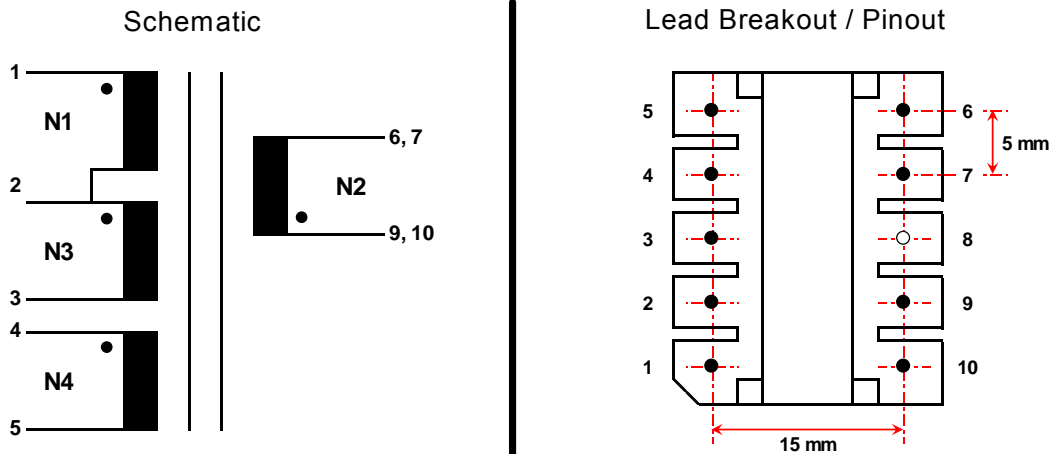

DN06040/D

Bill of Materials

| Ref | Part Type / Value | Comment | Footprint | Description | Manufacturer | Part Number |
|-----|-----------------------|-------------|---------------------|---|------------------|------------------------|
| C1 | 220nF X2 | 275VAC | 18X10mm, 15mm pitch | X-class EMI suppression capacitor | NIC | NPX224M275VX2MF |
| C2 | 47uF | 400V | Ø16mm, 7.5mm pitch | General purpose high voltage electrolytic | NIC | NRE-H470M400V16X31.5F |
| C3 | 470pF | 100V X7R | 1206 | Ceramic chip capacitor | NIC | NMC1206X7R471K100F |
| C4 | 100nF | 50V X7R | 0603 | Ceramic chip capacitor | NIC | NMC0603X7R104K50F |
| C5 | 220nF | 50V X7R | 0805 | Ceramic chip capacitor | NIC | NMC0805X7R224K50F |
| C6 | 4.7uF | 35V | Ø5mm, 2mm pitch | General purpose low voltage electrolytic | NIC | NRWA4R7M50V5X11F |
| C7 | 180pF | 50V NP0 | 0603 | Ceramic chip capacitor | NIC | NMC0603NPO181J50F |
| C8 | 47nF | 50V X7R | 0603 | Ceramic chip capacitor | NIC | NMC0603X7R473K50F |
| C9 | 220nF | 50V X7R | 0805 | Ceramic chip capacitor | NIC | NMC0805X7R224K50F |
| C10 | 10nF (0.01 uF) | 1kV | 1210 | Ceramic chip capacitor | JOHANSON | 102S41W103KV4E |
| C11 | 1uF | 50V | Ø5mm, 2mm pitch | General purpose low voltage electrolytic | NIC | NRWA1R0M50V5X11F |
| C12 | 1nF | Y1 | Radial, pitch 10mm | Ceramic Y-class capacitor | Murata | DE1E3KX102MN4AL01 |
| C13 | 470uF | 63V | Ø12.5mm, 5mm pitch | Miniature low impedance electrolytic | NIC | NRSZ471M63V12.5X25F |
| C14 | Not Inserted | | | | | |
| C15 | 220nF | 100V X7R | 1206 | Ceramic chip capacitor | NIC | NMC1206X7R224K100F |
| C16 | 1uF | 50V | 1206 | Ceramic chip capacitor | NIC | NMC1206X7R105K50F |
| D1 | 1N4007 | 1A, 1000V | Axial | Axial Lead, Standard Recovery | ON Semiconductor | 1N4007RLG |
| D2 | 1N4007 | 1A, 1000V | Axial | Axial Lead, Standard Recovery | ON Semiconductor | 1N4007RLG |
| D3 | 1N4007 | 1A, 1000V | Axial | Axial Lead, Standard Recovery | ON Semiconductor | 1N4007RLG |
| D4 | 1N4007 | 1A, 1000V | Axial | Axial Lead, Standard Recovery | ON Semiconductor | 1N4007RLG |
| D5 | MMSD4148 | 200mA, 100V | SOD-123 | Switching diode | ON Semiconductor | MMSD4148T1G |
| D6 | 20V | 1.5W | SMA | Zener Diode | ON Semiconductor | 1SMA5932BT3G |
| D7 | MURA160 | 1A, 600V | SMA | Ultrafast rectifier | ON Semiconductor | MURA160T3G |
| D8 | MMSD4148 | 200mA, 100V | SOD-123 | Switching diode | ON Semiconductor | MMSD4148T1G |
| D9 | MUR840 (MUR860 - Alt) | 8A, 400V | TO-220 | Ultrafast Power Rectifier | ON Semiconductor | MUR840G |
| D10 | 33V | 5%, 200mW | SOD323 | Zener diode | ON Semiconductor | MM3Z33VT1G |
| IC1 | NCP1351B | - | SOIC8 | Variable Off-Time PWM Controller | ON Semiconductor | NCP1351BDR2G |
| IC2 | HCPL-817 | Wide pitch | HCPL-817-300E | Opto-coupler HCPL-817 | Agilent | HCPL-817-WOAE |
| L1 | | - | WE-LF 662/SH | Common Mode Choke | Würth/Midcom | 744 662 0027 |
| AC | 2-Way | 5mm pitch | - | Screw Terminal | Keystone | 8718 |
| LED | 2-Way | 5mm pitch | - | Screw Terminal | Phoenix | 1985881 |
| M1 | 25.9°C/W | - | - | Heatsink | Aavid | 577102B00000G |
| M2 | 25.9°C/W | - | - | Heatsink | Aavid | 577102B00000G |
| Q1 | BC847 | 45V | SOT-23 | General purpose NPN | ON Semiconductor | BC847ALT1G |
| Q2 | IRFBC40A | 600V | TO-220 | MOSFET | IR | IRFBC40A |
| Q3 | BC857 | -45V | SOT-23 | General purpose PNP | ON Semiconductor | BC857ALT1G |
| R1 | 150R | 0.33W, 5% | 1210 | Resistor thick film NRC | NIC | NRC25J151F |
| R2 | 2k2 | 0.1W, 5% | 0603 | Resistor thick film NRC | NIC | NRC06J222F |
| R3 | 3k0 | 0.1W, 5% | 0603 | Resistor thick film NRC | NIC | NRC06J302F |
| R4a | 1R2 | 1W, 5% | 2512 | Resistor thick film NRC | NIC | NRC100J1R2F |
| R4b | 1R2 | 1W, 5% | 2512 | Resistor thick film NRC | NIC | NRC100J1R2F |
| R5 | 1M | 0.5W, 5% | Axial | Metal Film Resistor | Vishay | SFR2500001004J-R500 |
| R6 | 1M | 0.5W, 5% | Axial | Metal Film Resistor | Vishay | SFR2500001004J-R500 |
| R7 | 2k2 | 0.125W, 5% | 0805 | Resistor thick film NRC | NIC | NRC10J222BF |
| R8 | 10R | 0.25W, 5% | 1206 | Resistor thick film NRC | NIC | NRC12J100F |
| R9 | 6k8 | 0.1W, 5% | 0603 | Resistor thick film NRC | NIC | NRC06J682TRF |
| R10 | 12k | 2W, 5% | Axial | Carbon film resistor | NIC | NCF200J123TRF |
| R11 | 200R | 0.125W, 5% | 0805 | Resistor thick film NRC | NIC | NRC10J201F |
| R12 | 1R8 | 0.33W, 1% | 1210 | Resistor thick film NRC | NIC | NRC25J1R8F |
| R13 | 1R8 | 0.33W, 1% | 1210 | Resistor thick film NRC | NIC | NRC25J1R8F |
| R14 | 2K2 | 0.125W, 5% | 0805 | Resistor thick film NRC | NIC | NRC10J222BF |
| R15 | 4k3 | 0.125W, 5% | 0805 | Resistor thick film NRC | NIC | NRC10J432F |
| R16 | 0 ohm Short | 0.125W | 0805 | Resistor Thick Film Chip | Vishay | CRCW08050000Z0EA |
| Tx1 | 25W LED TRANSFORMER | - | NIC 10 pin vertical | 25W Flyback transformer | NIC | NLT282224W3P4020S5P10F |

Component Placement and PCB Layout

Top view

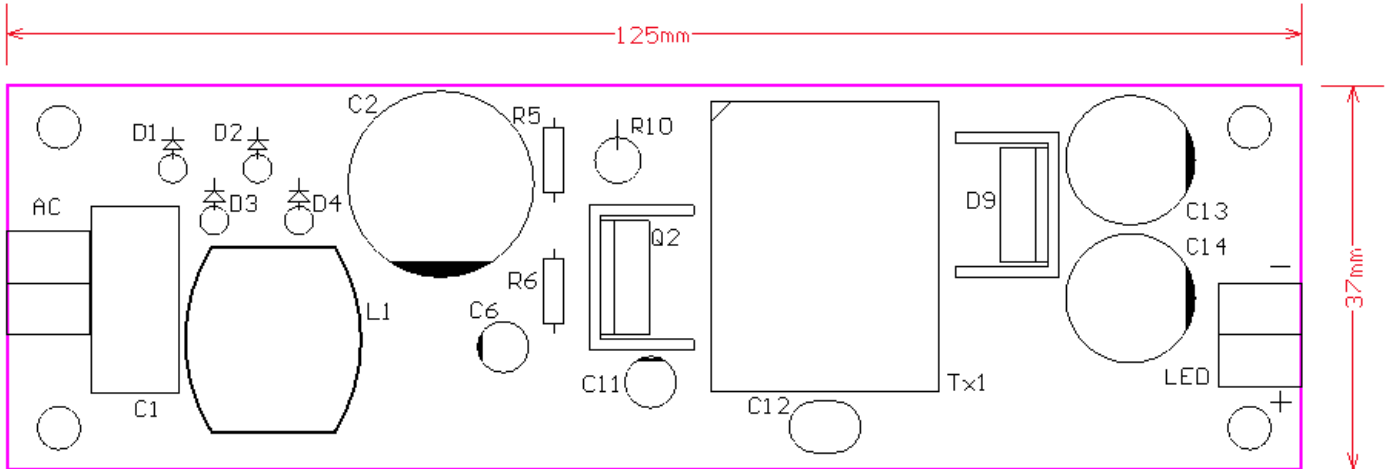

Bottom view

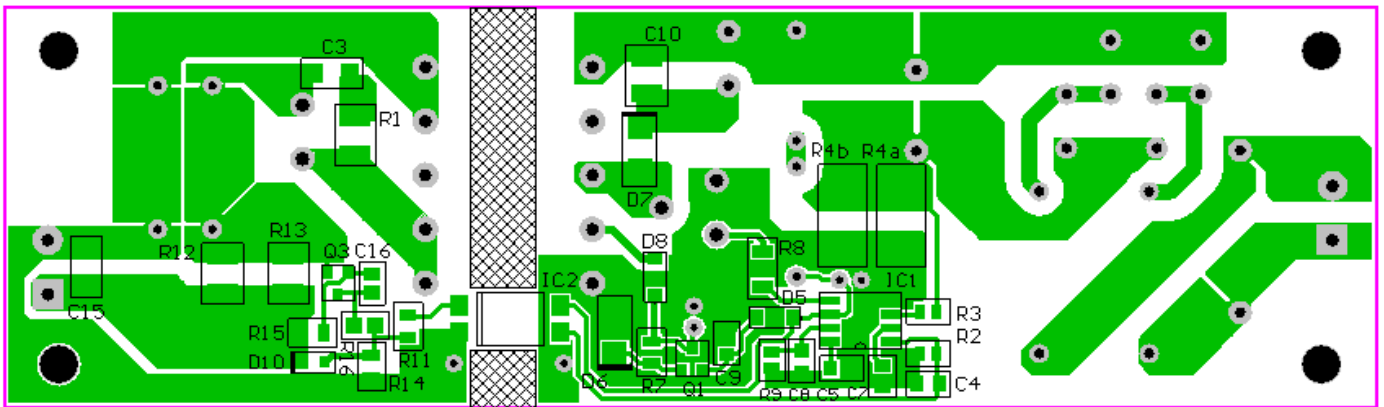

Completed Demo Board, Side View

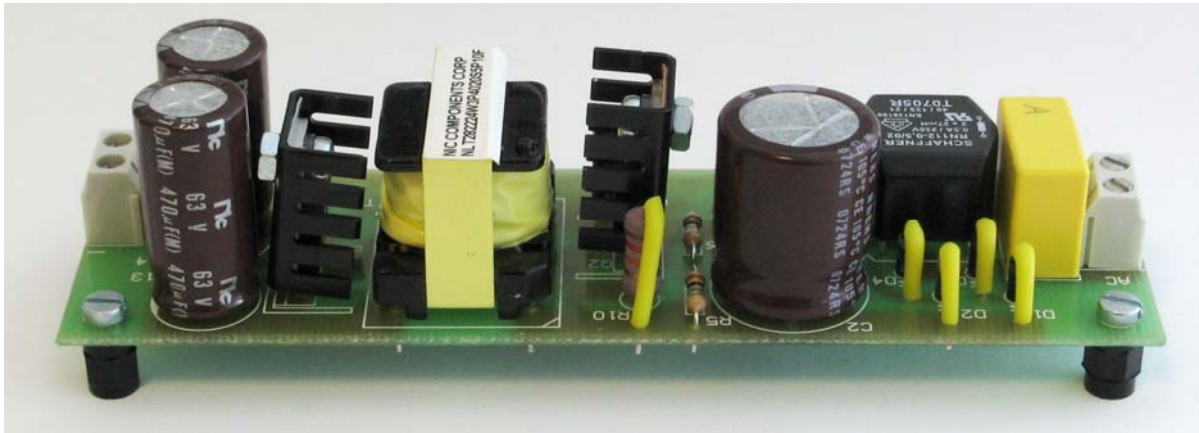

Typical Operational Results

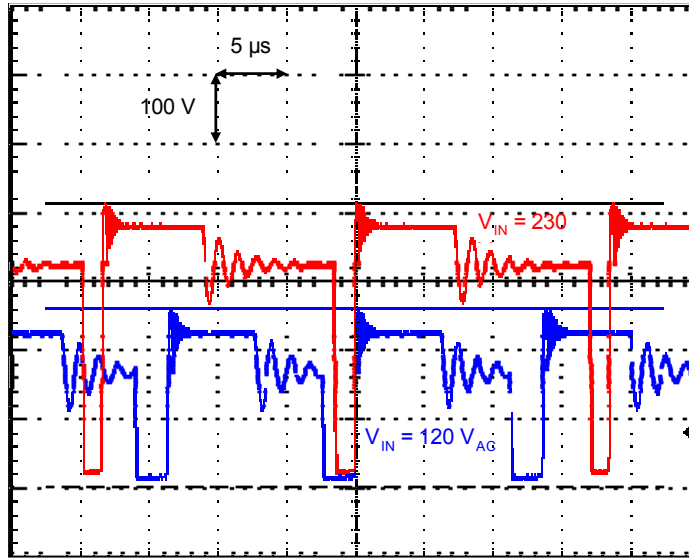

Drain waveform at 120 Vac and 230 Vac

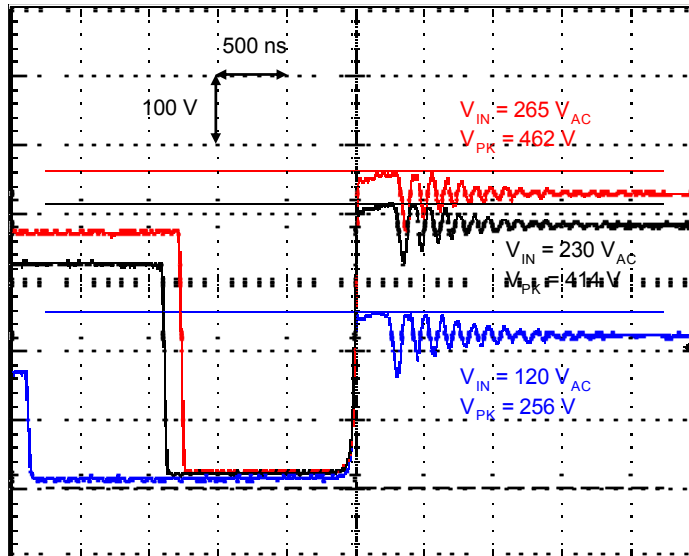

Turn-off in detail at 120 Vac, 230 Vac and 265 Vac

Typical Evaluation Results

Efficiency versus Line and Load @ 700mA
 $T_a = 21^\circ\text{C} / 70^\circ\text{F}$

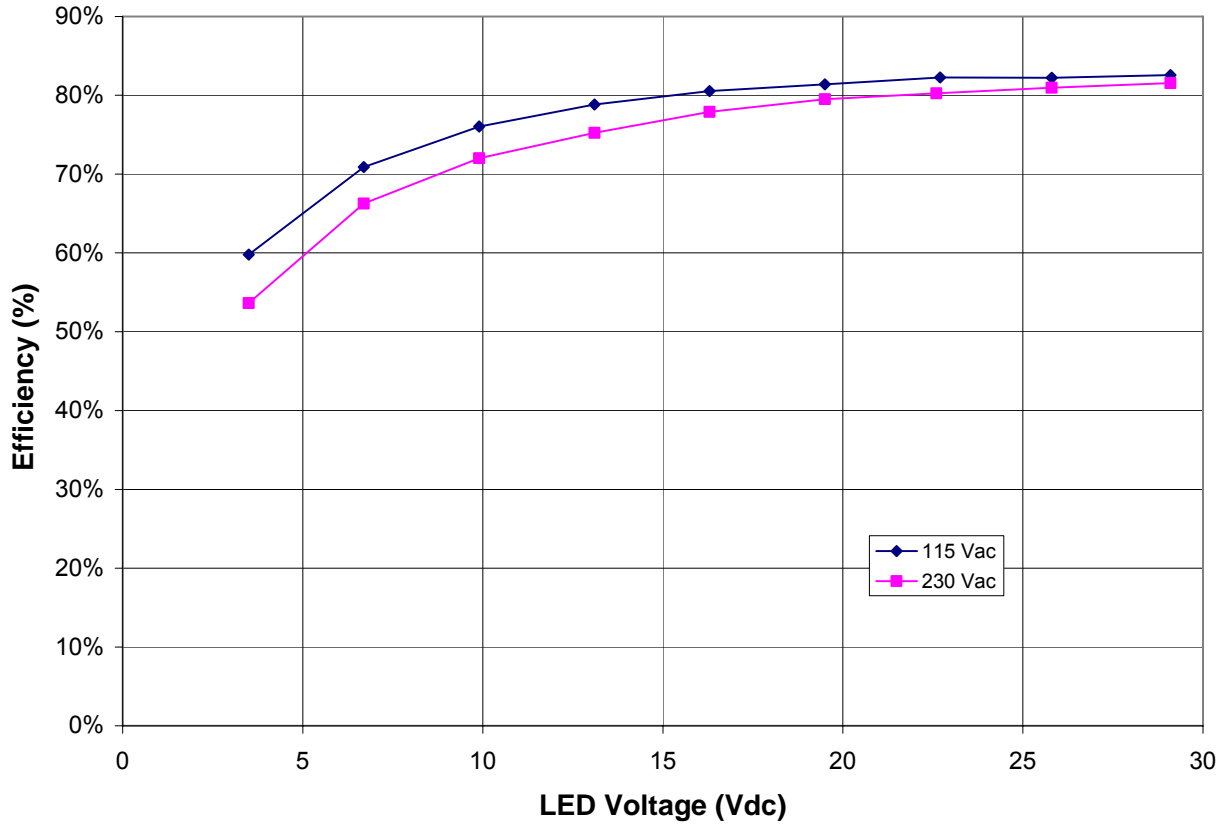

Current Regulation versus Forward Voltage @ 700mA
 $T_a = 21^\circ\text{C} / 70^\circ\text{F}$

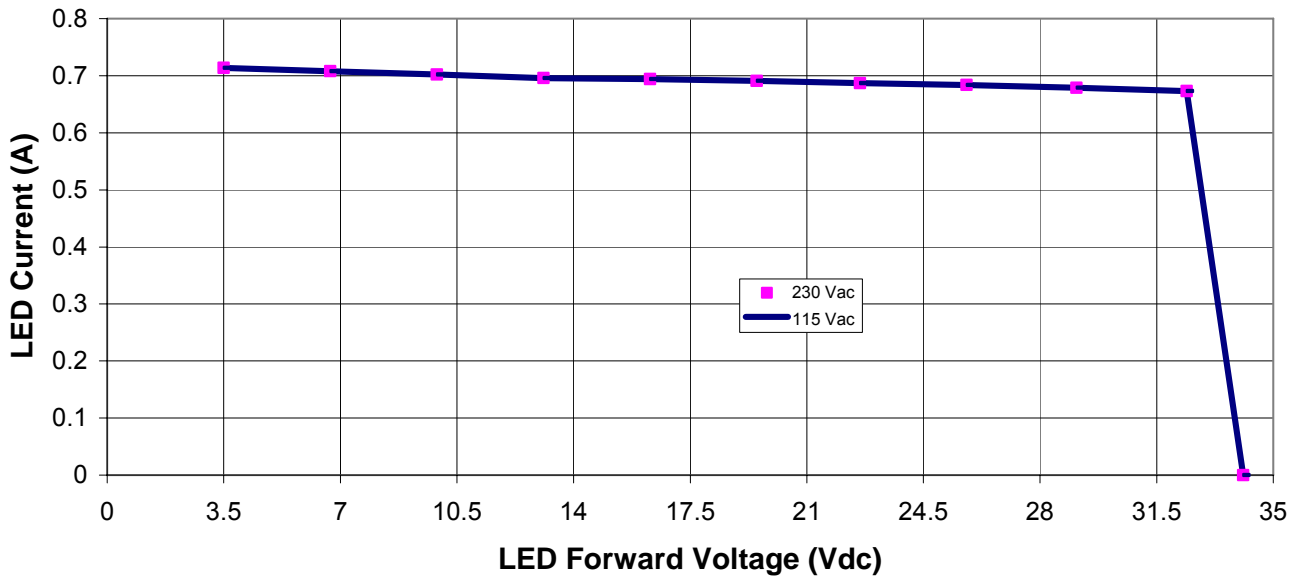

Modifying the Board for Other LED currents

The constant current constant voltage secondary control loop is very flexible and is implemented using a PNP (Q3) with a pair of current sense resistors (R12 & R13) to regulate the current and provide control of the optocoupler to the NCP1351. In addition, there is a maximum voltage control loop that is implemented using zener D10. To modify this circuit for alternate current / voltage configurations, these components should be modified. The table on the front page shows several other possible configuration options. Note because this design is ultimately power limited based on the transformer design and FET used, as the current decreases, the maximum voltage capability increases. For example, for 20W output, the maximum voltage at 350 mA could be as high as 57 Vdc. Under UL1310, Class 2 power supplies for use in dry/damp environments are allowed to have a maximum output voltage of 60 Vdc. On the demo board, Q3 is implemented using a BC857 transistor which has a maximum V_{CEO} of -45 Vdc. If a higher operating voltage is required, this transistor can be changed to a BC856 (maximum V_{CEO} of -65 Vdc). The figure below shows the current regulation performance for a nominal 350 mA output current with the component changes as noted.

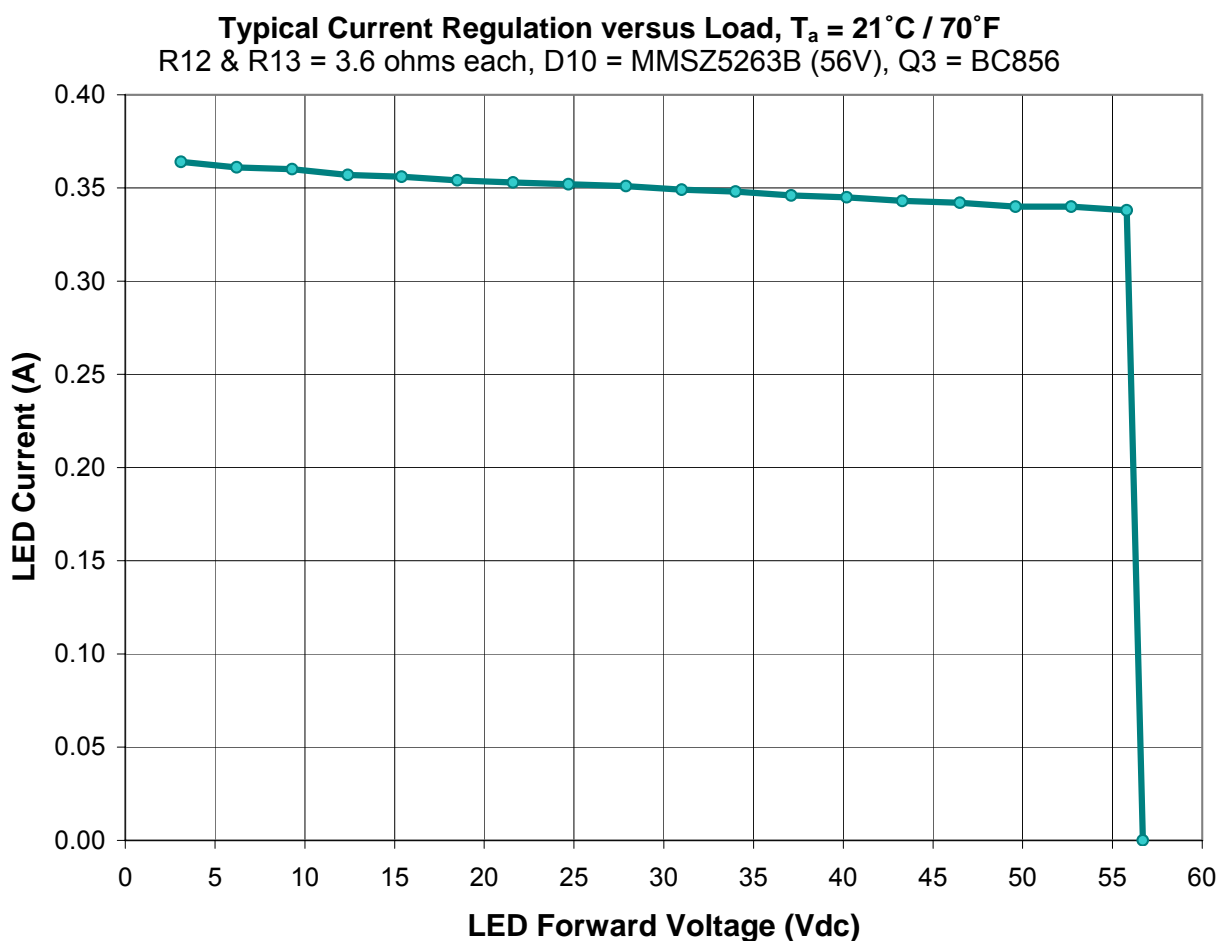

© 2008 ON Semiconductor.

Disclaimer: ON Semiconductor is providing this design note "AS IS" and does not assume any liability arising from its use; nor does ON Semiconductor convey any license to its or any third party's intellectual property rights. This document is provided only to assist customers in evaluation of the referenced circuit implementation and the recipient assumes all liability and risk associated with its use, including, but not limited to, compliance with all regulatory standards. ON Semiconductor may change any of its products at any time, without notice.

Design note created by Anthony Middleton, e-mail: Anthony.Middleton@onsemi.com