

DETAILS

Product Number	FCN13741_GERI-RZ
Family	Geri
Type	Pack
Color	white
Diameter	45 + 45 mm
Height	32,8 mm
Style	square
Optic Material	PMMA
Holder Material	
Fastening	pin, screw, glue
Status	production ready
ROHS Compliant	Yes
Date Updated	26/06/2015



OPTICAL PROPERTIES

LED	Viewing	Light	Efficiency	cd/lm	Connector
	Angle	Beam			
MC-E RGB	15 deg	Spot	90 %	7.800	-
XM-L RGB	16 deg	Spot	90 %	7.500	-
XQ-E HI RGBW	17 deg	Spot	85 %	6.510	-
XQ-E HD RGBW	17 deg	Spot	86 %	5.200	-
XP-G3	15 deg	Spot	85 %	7.200	-
XT-E	15 deg	Spot	84 %	6.600	-
LUXEON Z RGB	15 deg	Spot	89 %	7.600	-
LUXEON C RGBW	20 deg	Spot	89 %	5.060	-
Ostar-SMT RGB	13 deg	Spot	89 %	9.800	-
OSTAR Stage (S2WP)	15 deg	Spot	87 %	8.660	-
F50360 (RGB)	14 deg	Spot	90 %	9.000	-

Relative intensity of FCN13741_GERI-RZ_(XQ-E_HI_RGBW)

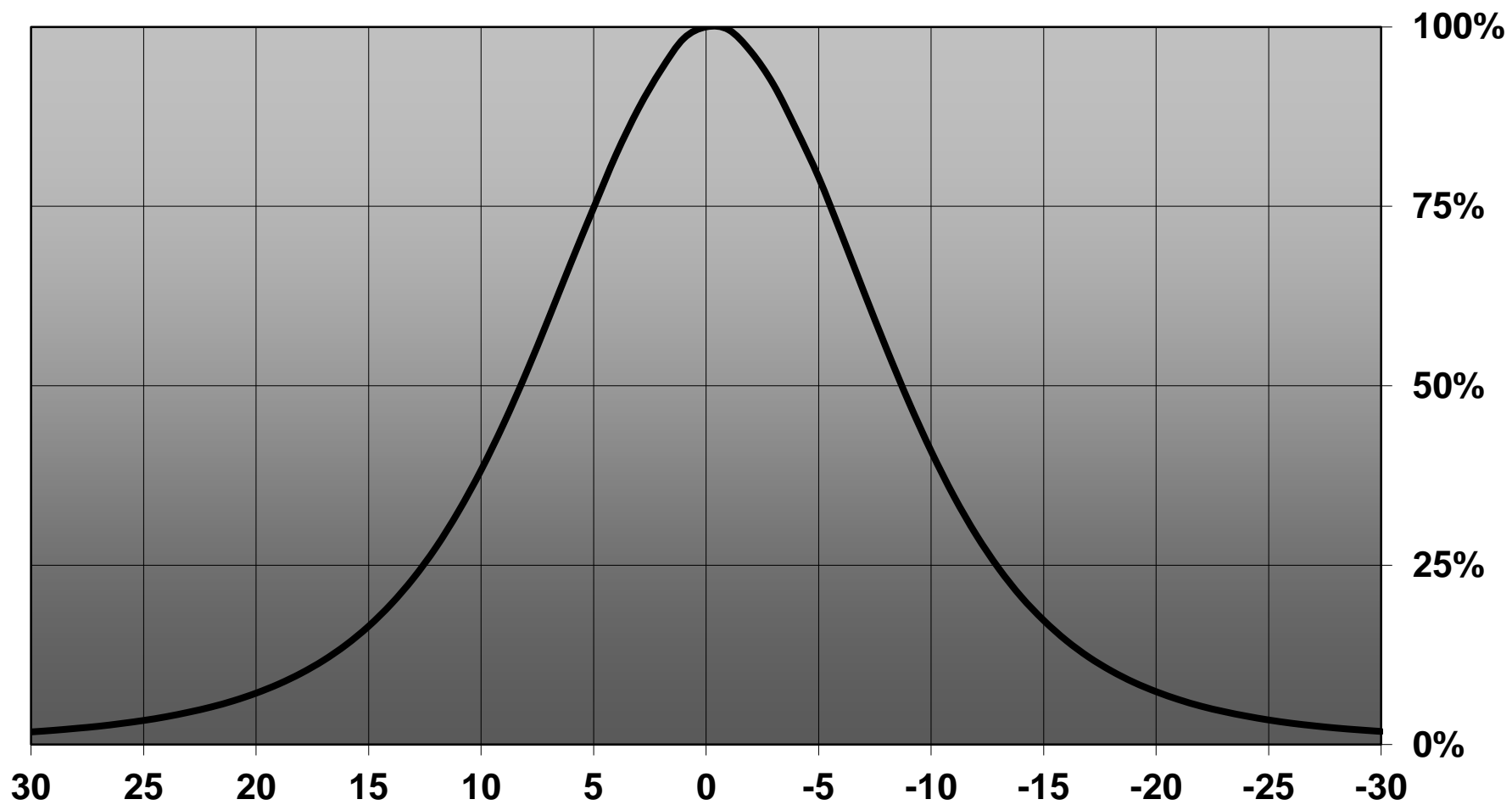

Relative intensity of FCN13741_GERI-RZ_(Osram_Stage_S2WP)

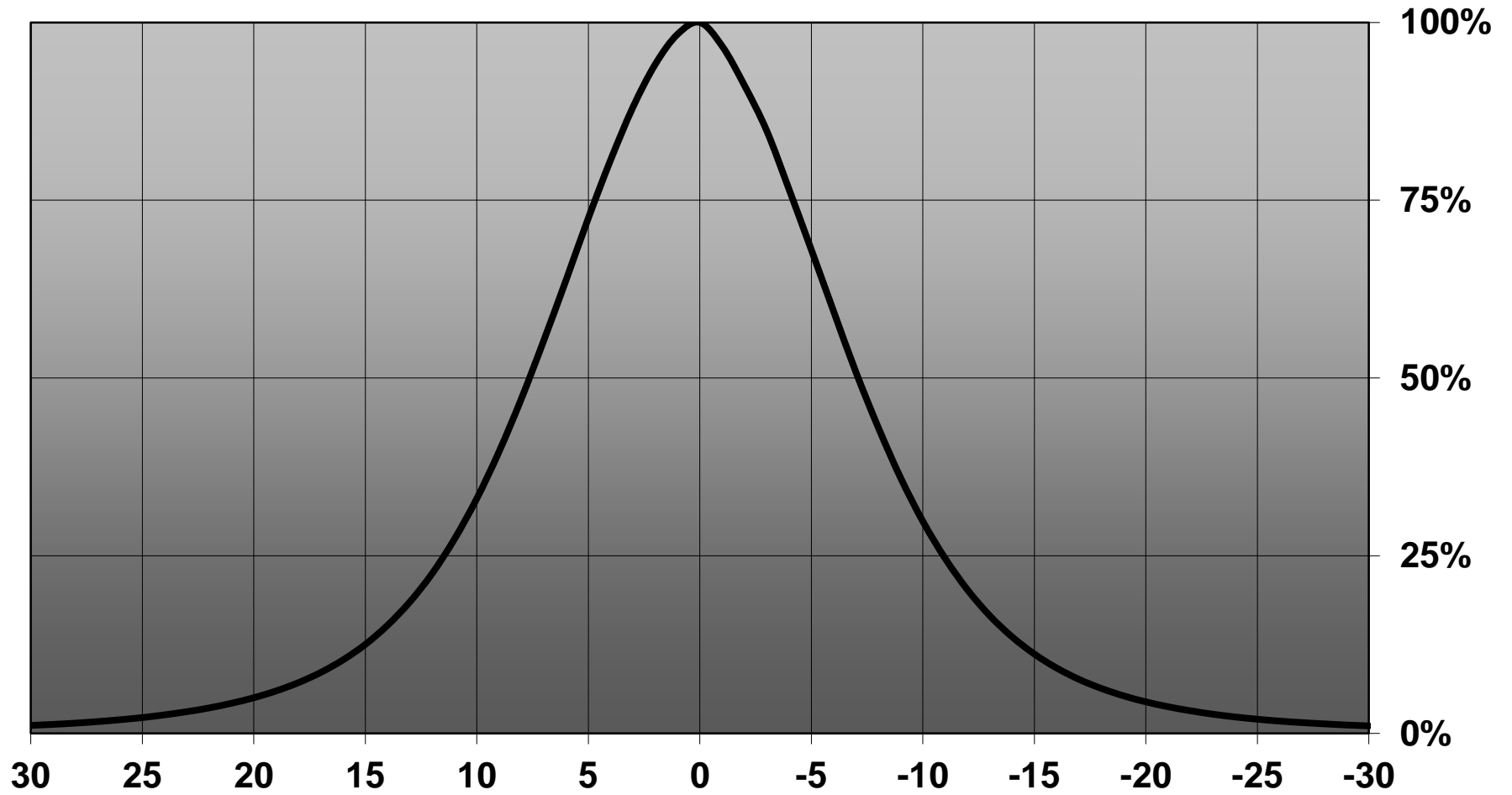

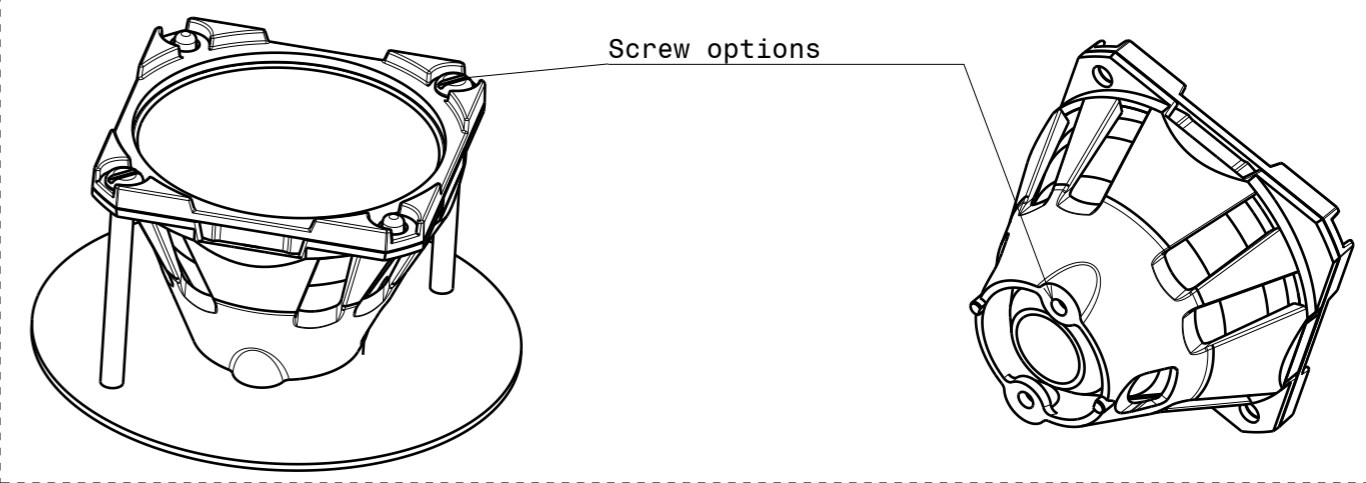
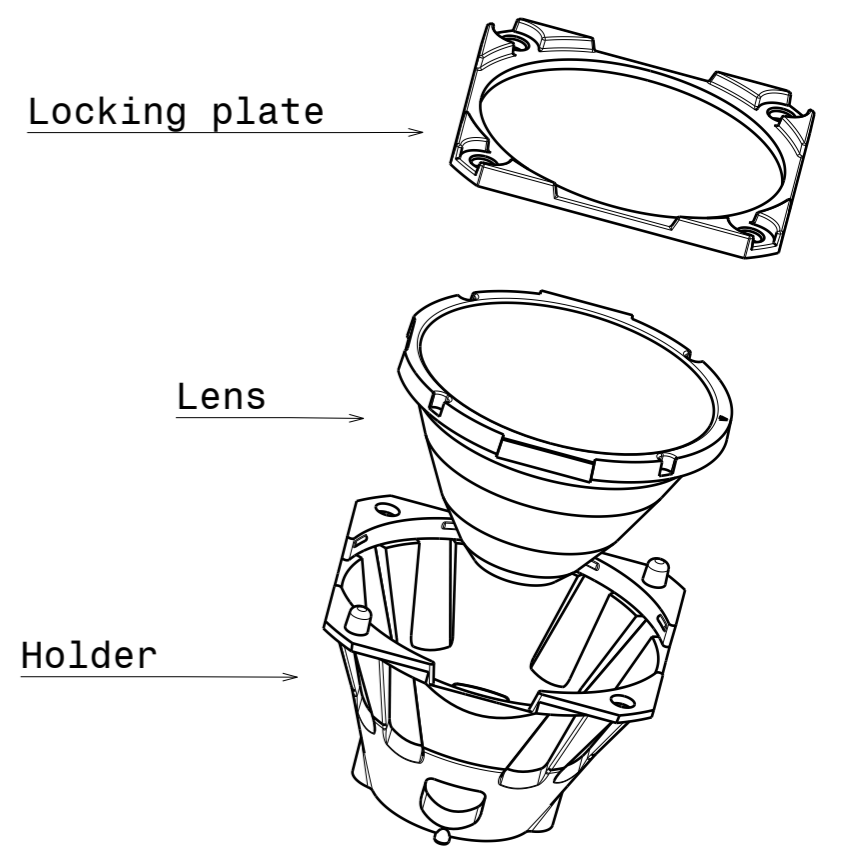
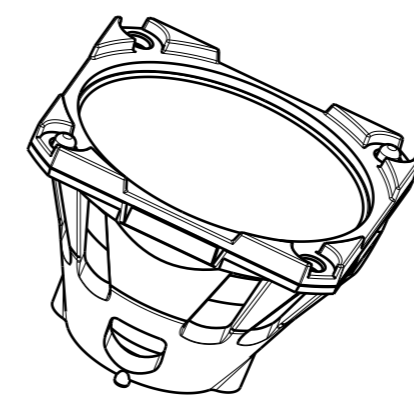
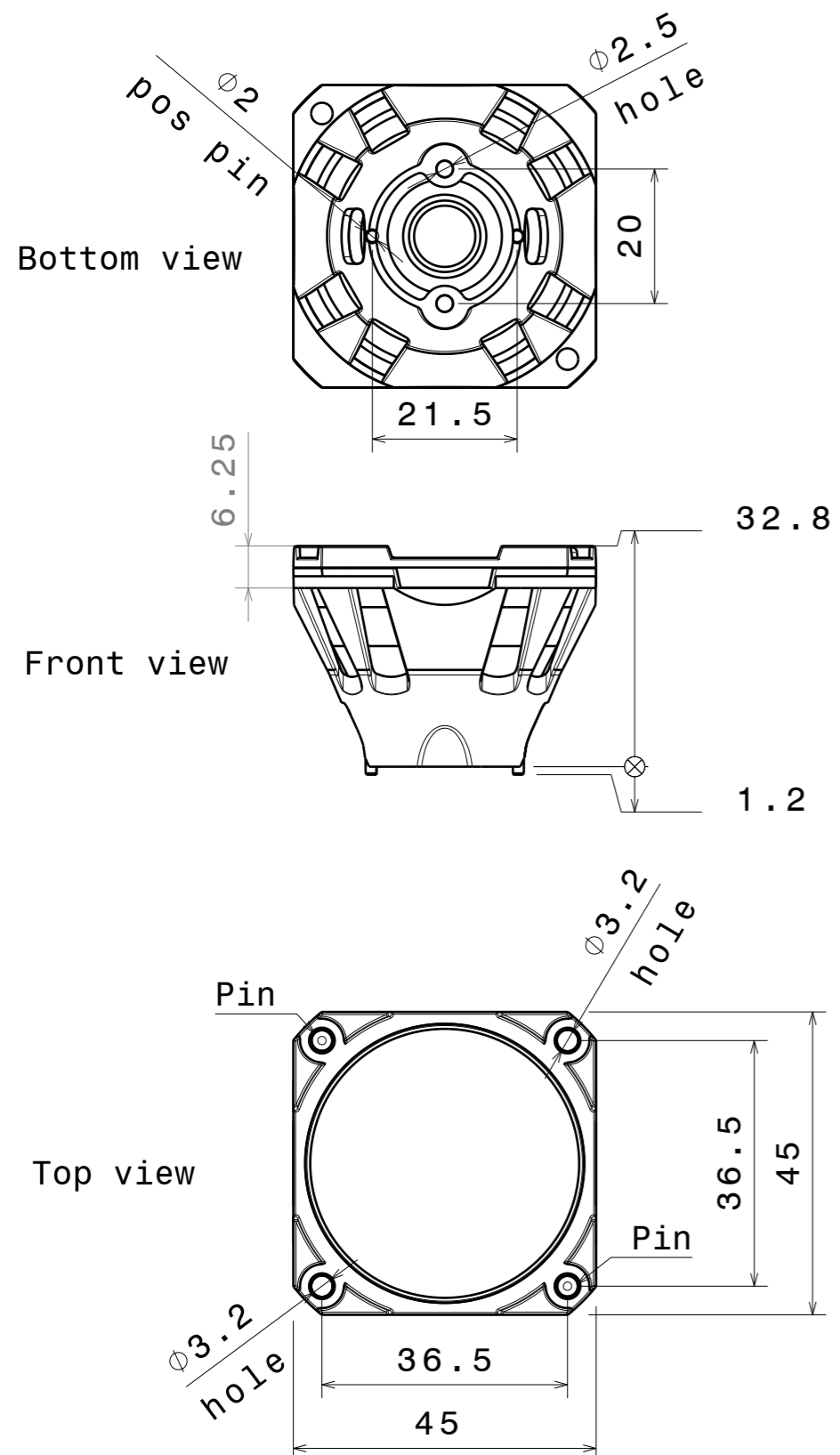

INDEX	PART NO	DESCRIPTION	MATERIAL	COLOUR
1	CN13741	GERI-RZ	Optic PMMA / Holder PC	White

Tolerances if not otherwise shown
 According to DIN ISO 2768-1
 Linear measures:
 Up to 30mm class M, otherwise class C.
 According to DIN ISO 2768-2
 Form and position: class L

LEDiL LediL Oy
 Salorankatu 10
 FIN 24240 SALO
 Finland

THIRD ANGLE PROJECTION:

DRAWING TITLE
 CN13741_GERI-RZ

This drawing is the property of LEDiL Oy. It may not be reproduced, copied or communicated without a written agreement with LEDiL Oy."

SIZE A3 **PART NUMBER** CN13741

SCALE 1:1 **WEIGHT** **SHEET** 1/1

Ledil CN13741_GERI-RZ_(MC-E_RGBW) / LDC (Linear)

Luminaire: Ledil CN13741_GERI-RZ_(MC-E_RGBW)

Lamps: 1 x CREE_MC-E_RGBW_170.896lm@250mA_P=2.8W_I=0.25A

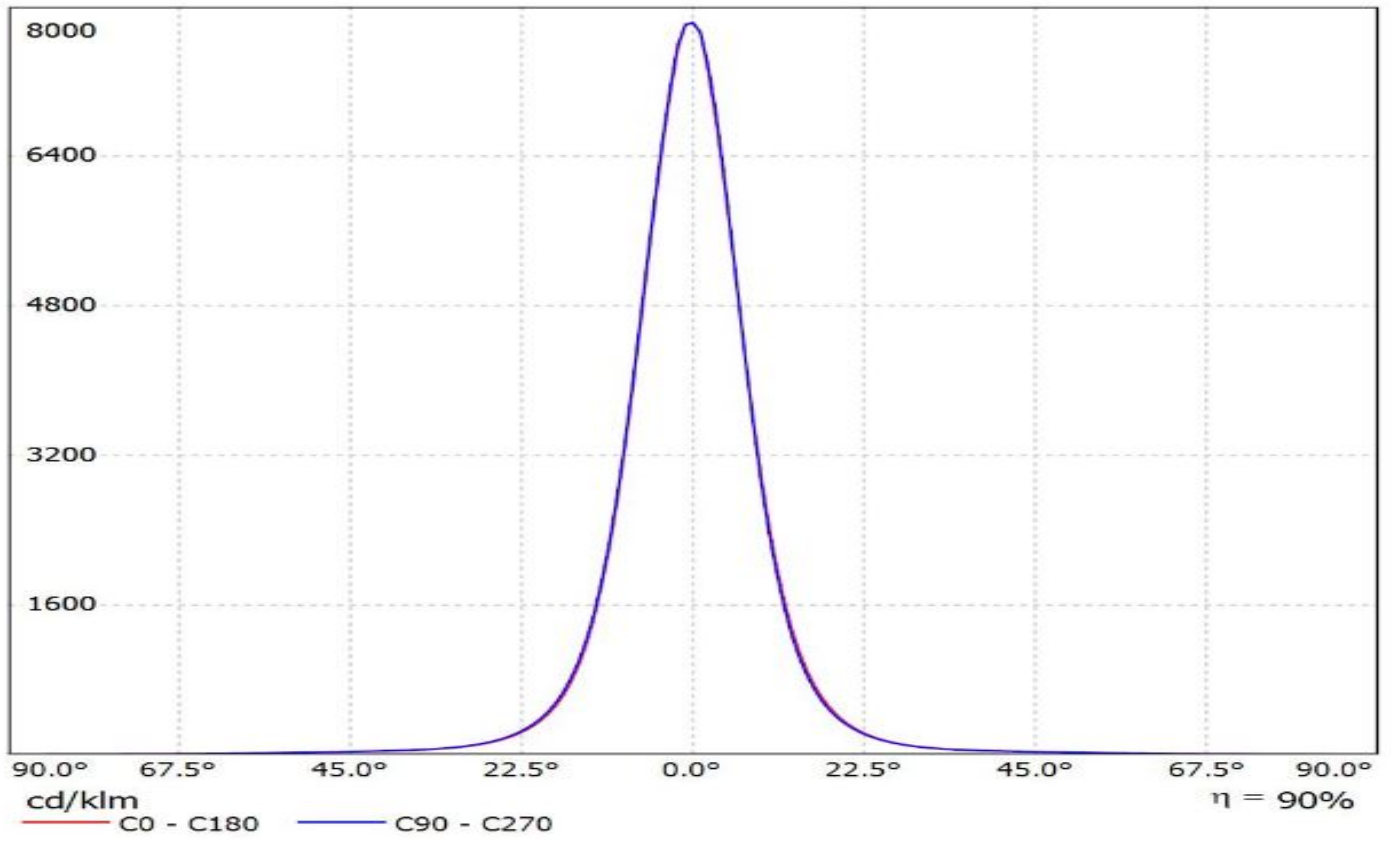

Ledil CN13741_GERI-RZ_(XM-L_RGBW) / LDC (Linear)

Luminaire: Ledil CN13741_GERI-RZ_(XM-L_RGBW)
Lamps: 1 x CREE_XM-L_RGBW_(XMLCTW-A0-0000-00C3AAAA1)
_215.885lm@250mA_P=2.7W_I=0.25A

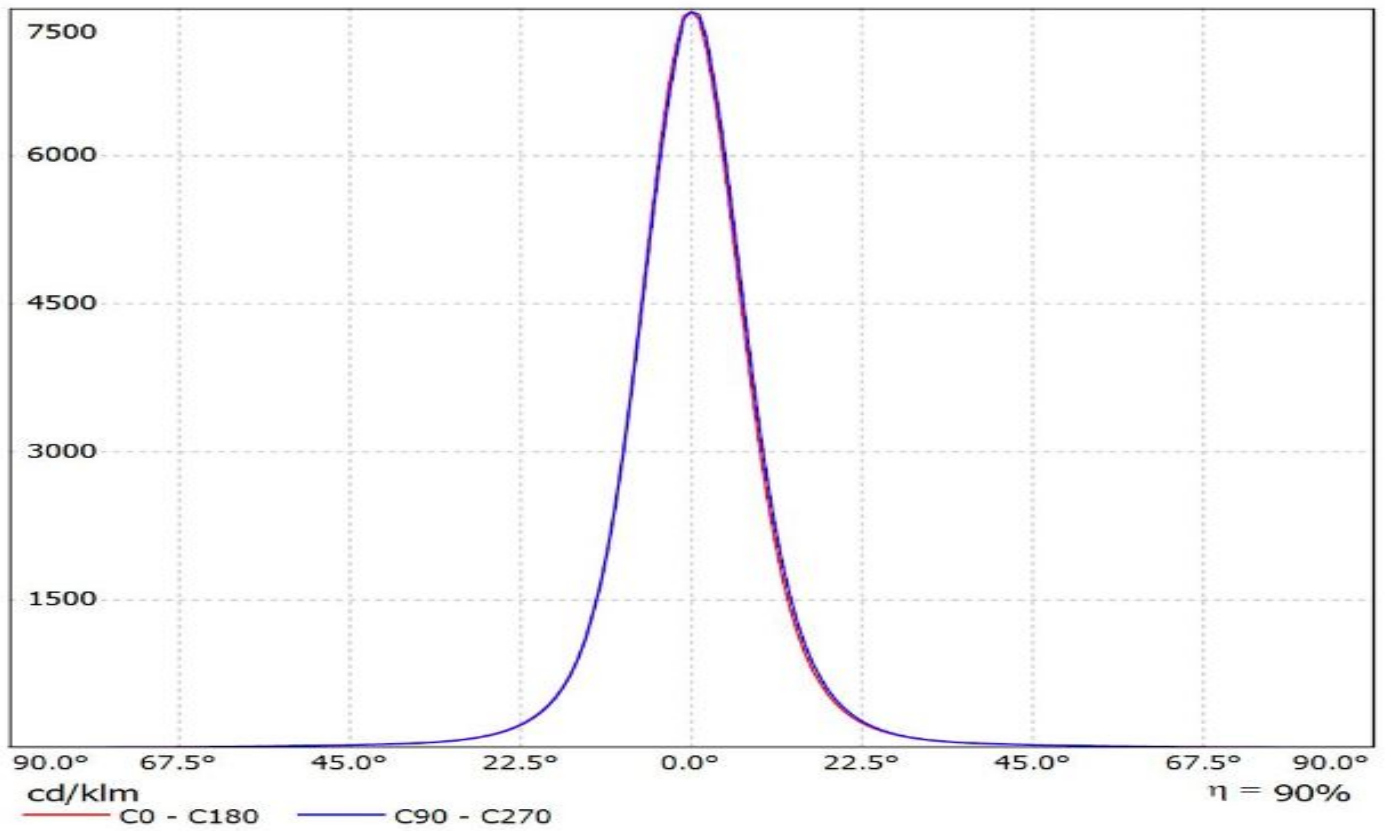

Luminaire: Ledil FCN13741_GERI-RZ_(XQE_HI_RGBW)

Lamps: 1 x Cree_XQE_HI_RGBW_212.518lm@250mA_P=2.7397W_I=0.250A

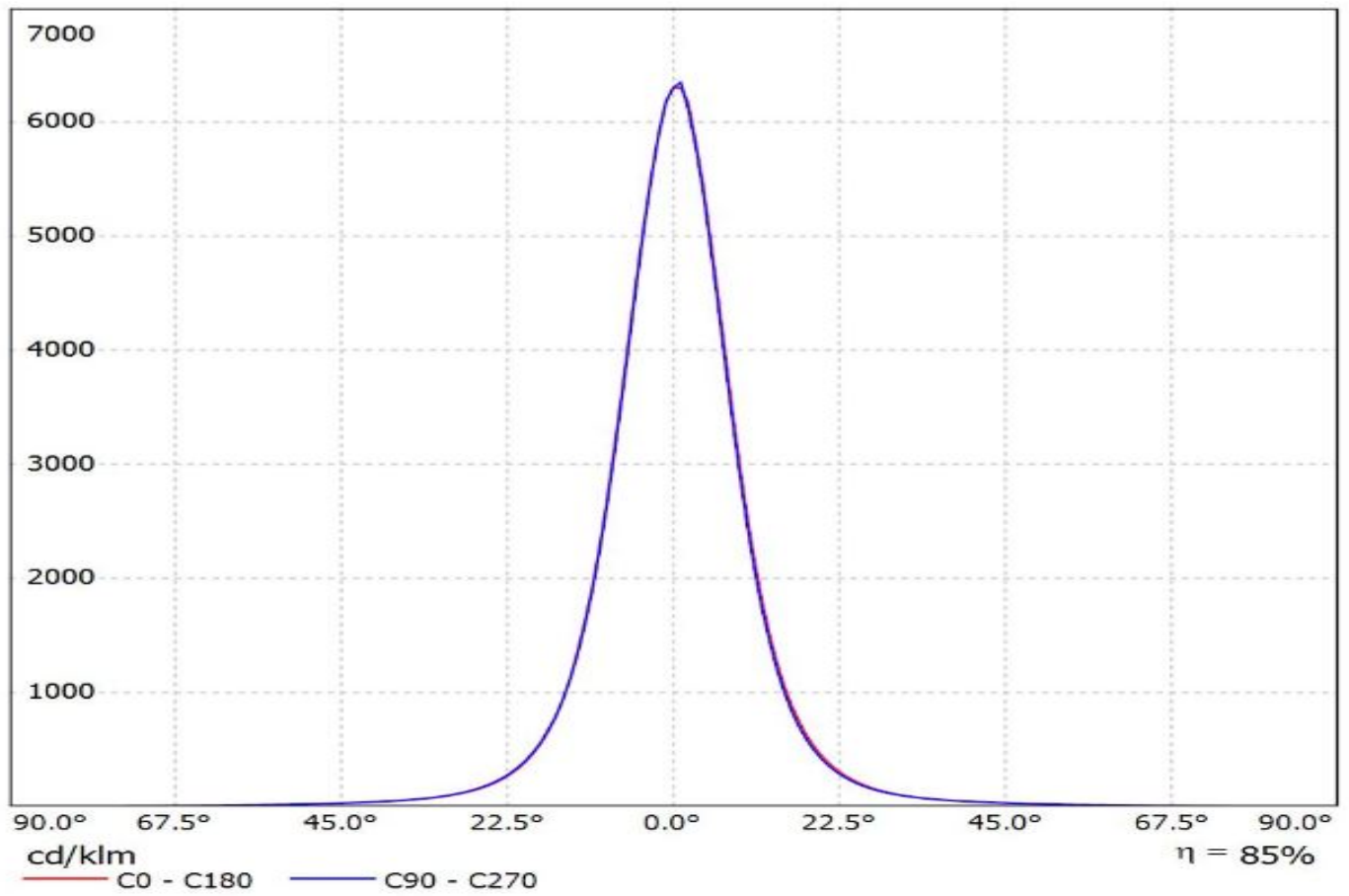

Luminaire: Ledil FCN13741_GERI-RZ (XQ-E_HD_RGBW)

Lamps: 1 x Cree_XQ-E_HD_RGBW_233.24lm@250mA_P=2.7265W_I=0.250A

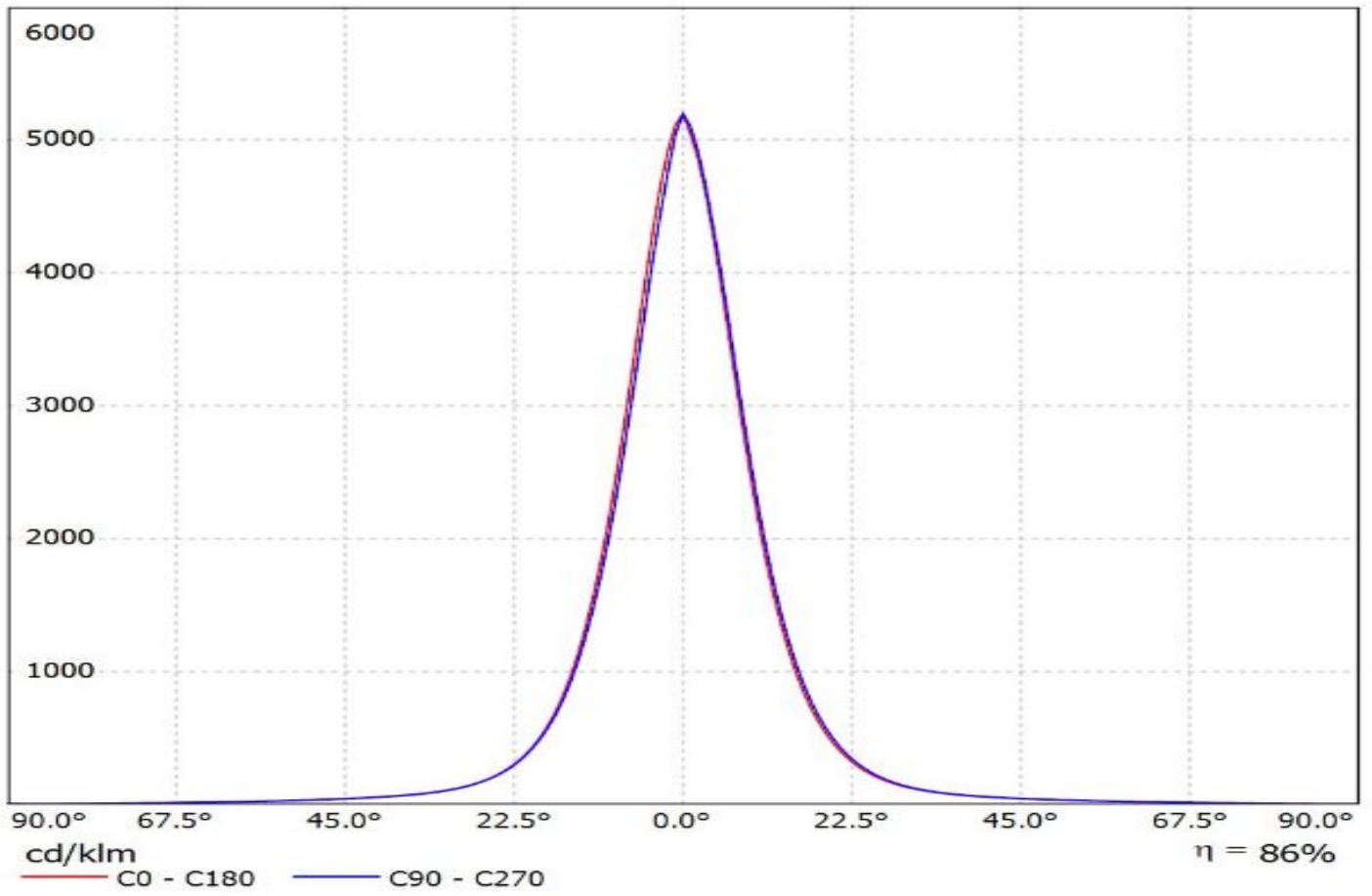

Luminaire: Ledil FCN13741_GERI-RZ_(XP-G3)
Lamps: 1 x Cree_XP-G3_109.458lm@250mA_P=0.738275W_I=0.250A

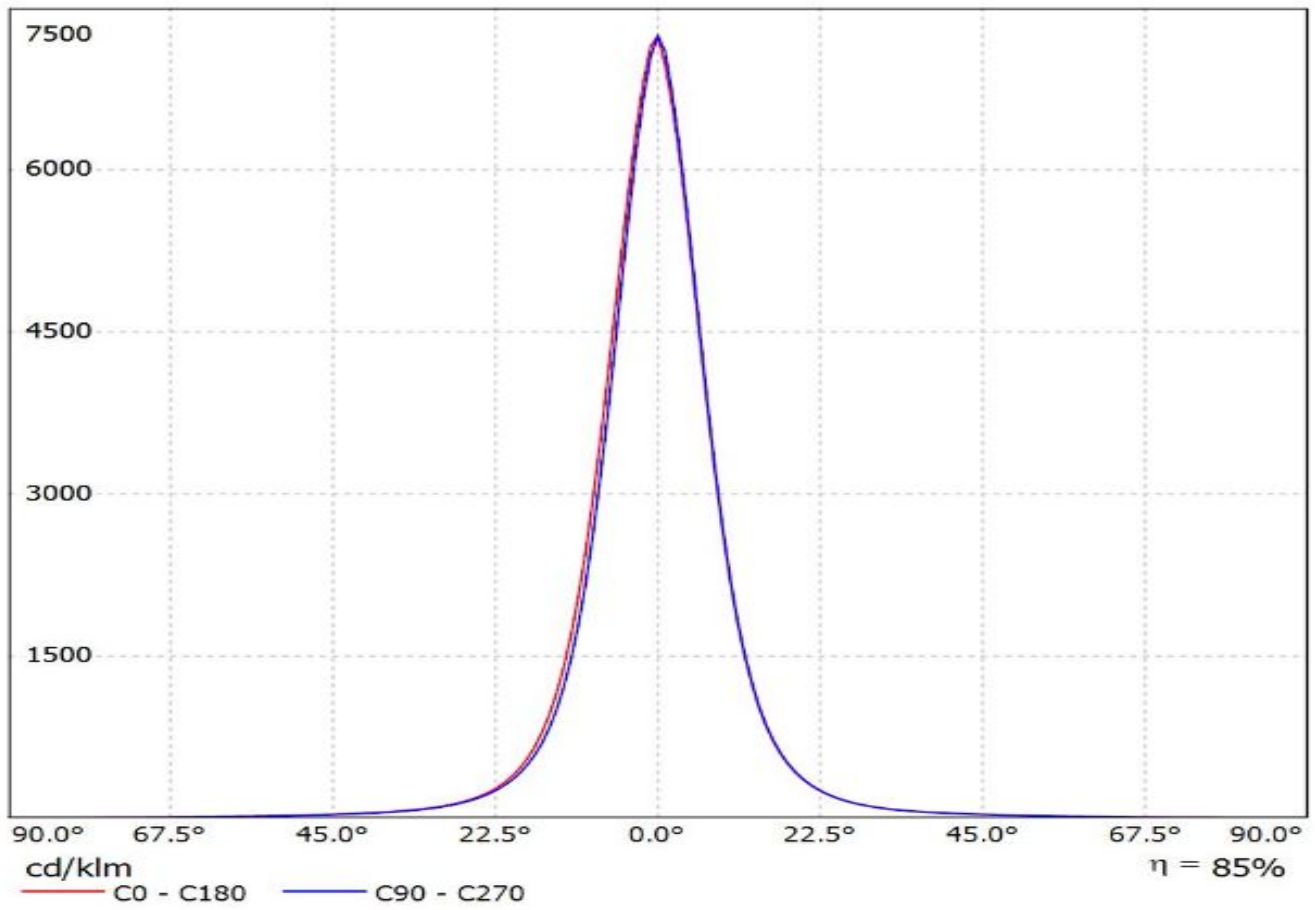

Luminaire: Ledil FCN13741_GERI-RZ_(XT-E)

Lamps: 1 x Cree_XT-E_(XT-EAWT-0-2A0-R30-FB-0001)_100.346lm@250mA_P=0.795125W_I=0.250A

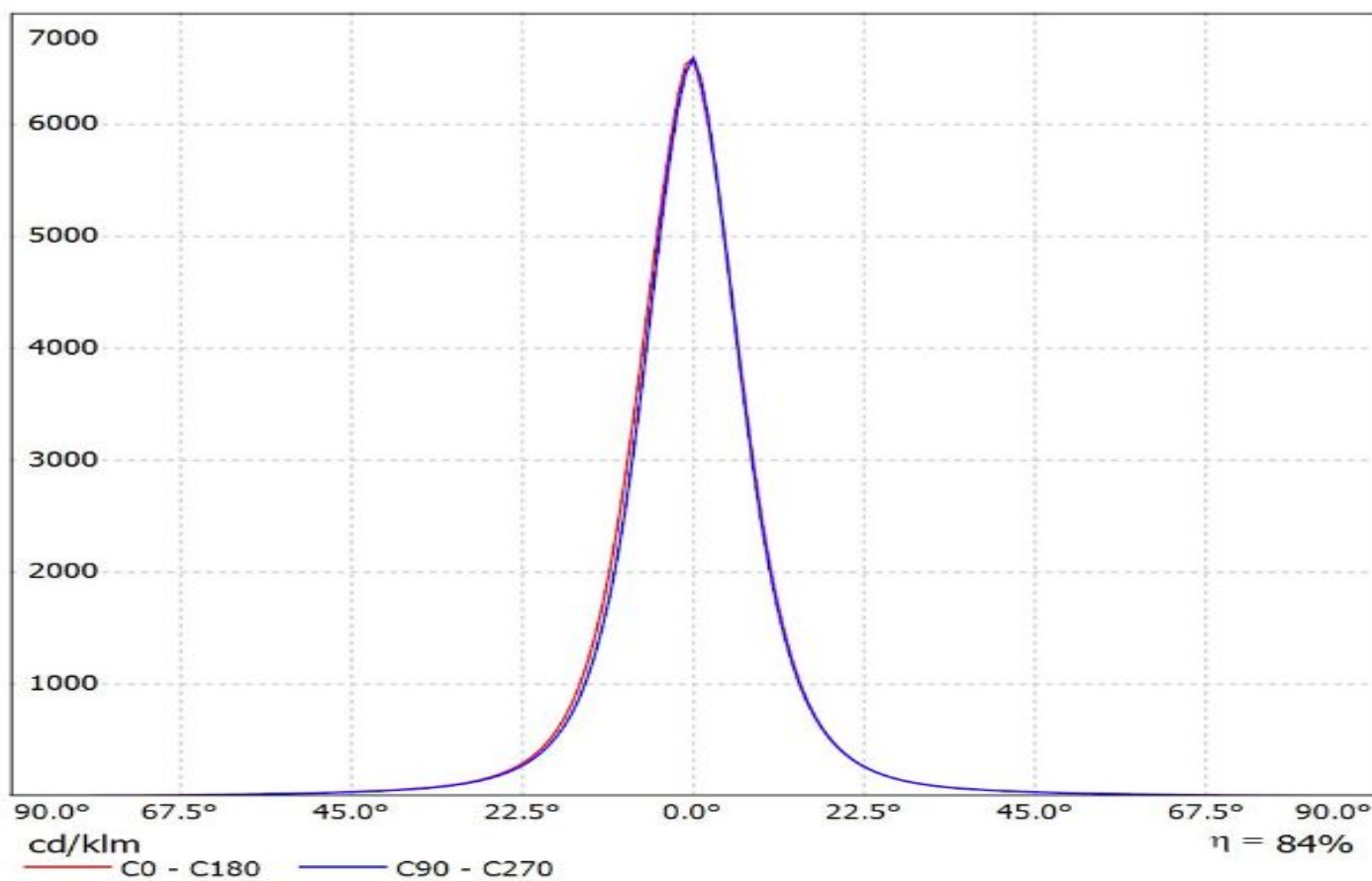

Ledil CN13741_GERI-RZ_(LUXEON_Z_RGBW) / LDC (Linear)

Luminaire: Ledil CN13741_GERI-RZ_(LUXEON_Z_RGBW)

Lamps: 1 x LUXEON_Z_RGBW_165.276lm@250mA_P=2.6W_I=0.25A

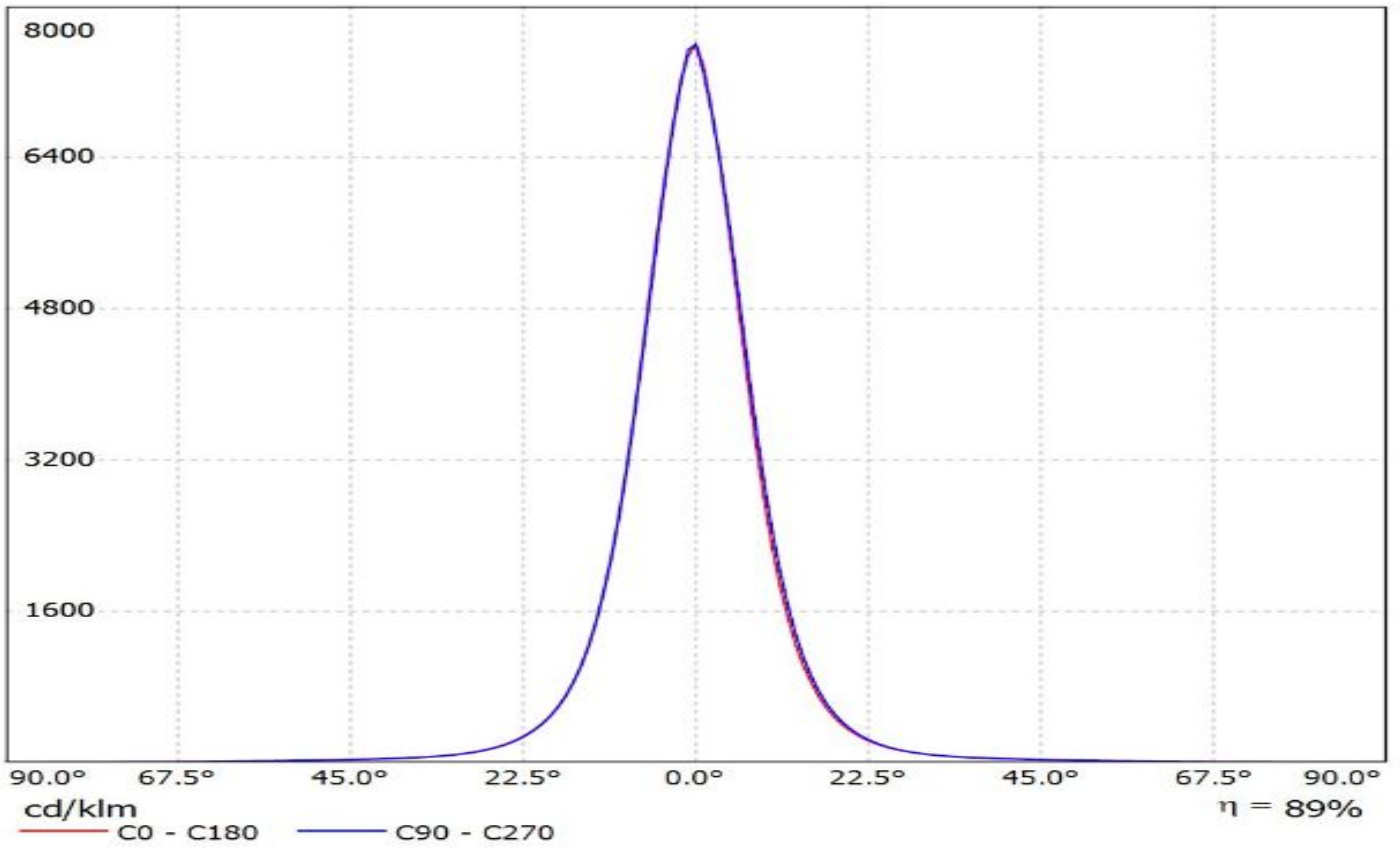

Luminaire: LEDiL Oy FCN13741_GERI-RZ_(Luxeon_C_RGBW)
Lamps: 1 x Luxeon_C_RGBW_208.984lm@250mA_P=2.5474W_I=0.250A

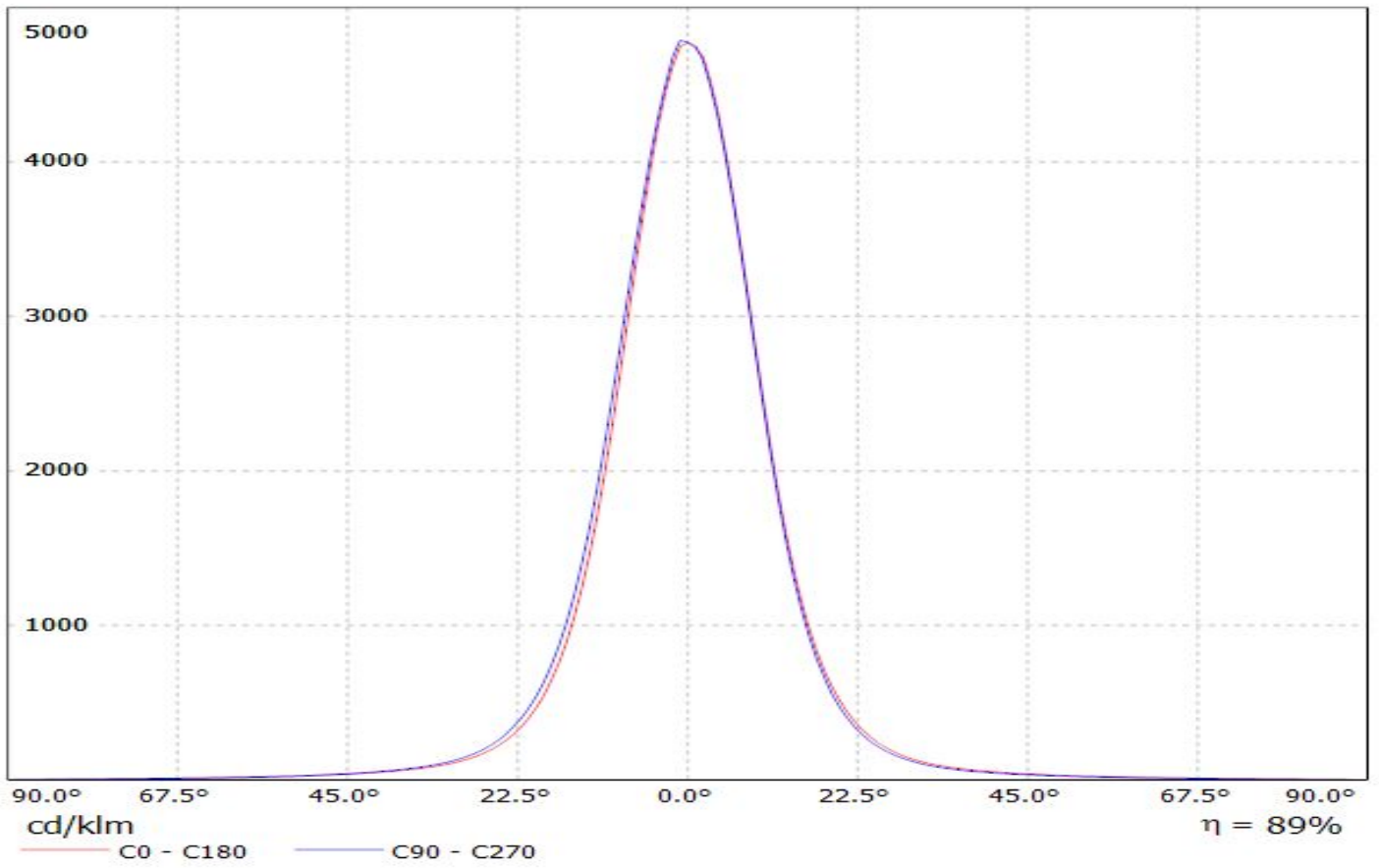

Ledil CN13741_GERI-RZ_(OSTAR-SMT_RGB) / LDC (Linear)

Luminaire: Ledil CN13741_GERI-RZ_(OSTAR-SMT_RGB)

Lamps: 1 x OSRAM_OSTAR-SMT_RGB_168.879lm@250mA_P=3W_I=0.25A

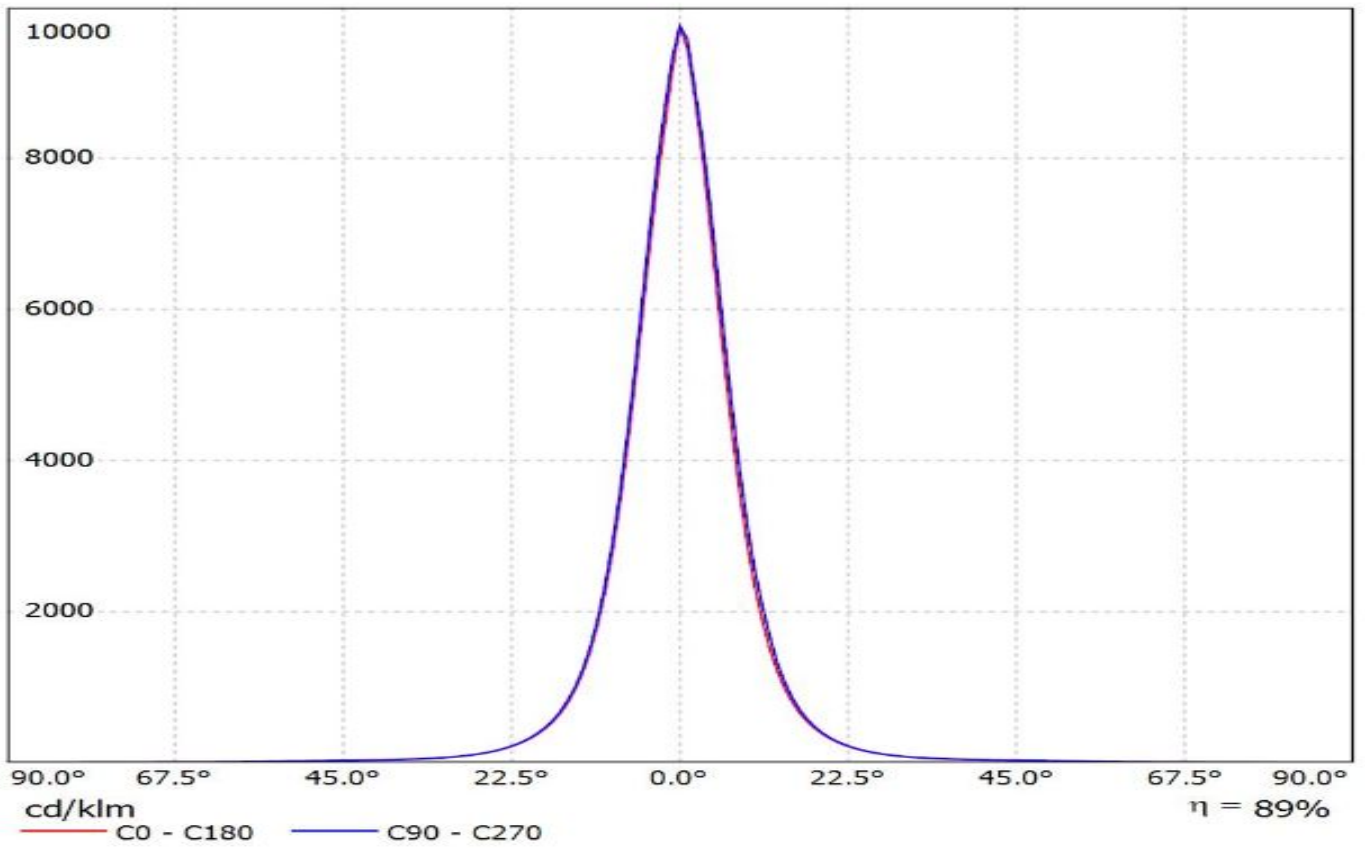

Ledil CN13741_GERI-RZ_(F50360_RGB) / LDC (Linear)

Luminaire: Ledil CN13741_GERI-RZ_(F50360_RGB)

Lamps: 1 x SEOUL_F50360_RGB_(-01_QLSRBH)_57.1364lm@250mA_P=2.1W_I=0.25A

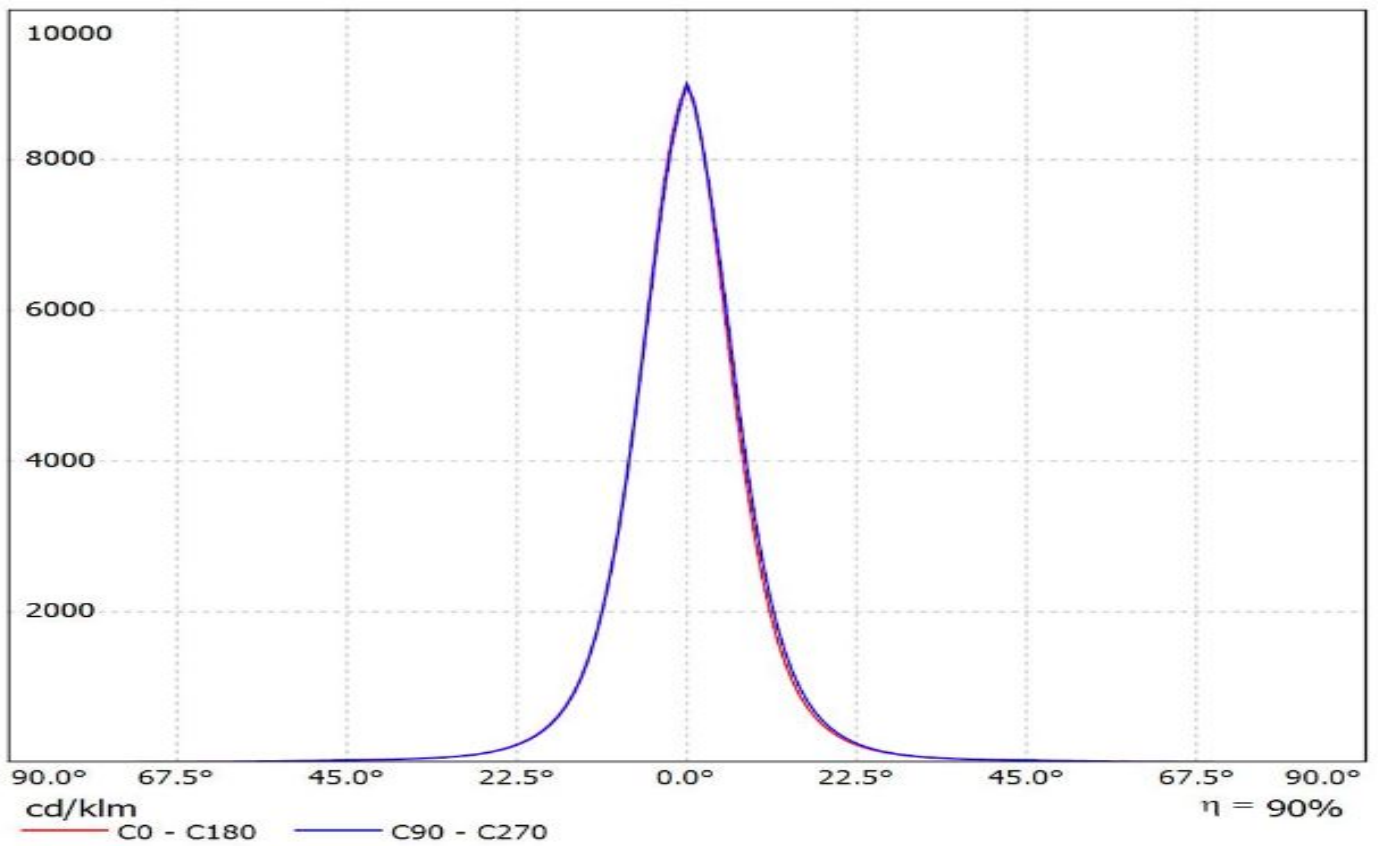

Ledil CN13741_GERI-RZ_(MC-E_RGBW) / LDC (Polar)

Luminaire: Ledil CN13741_GERI-RZ_(MC-E_RGBW)

Lamps: 1 x CREE_MC-E_RGBW_170.896lm@250mA_P=2.8W_I=0.25A

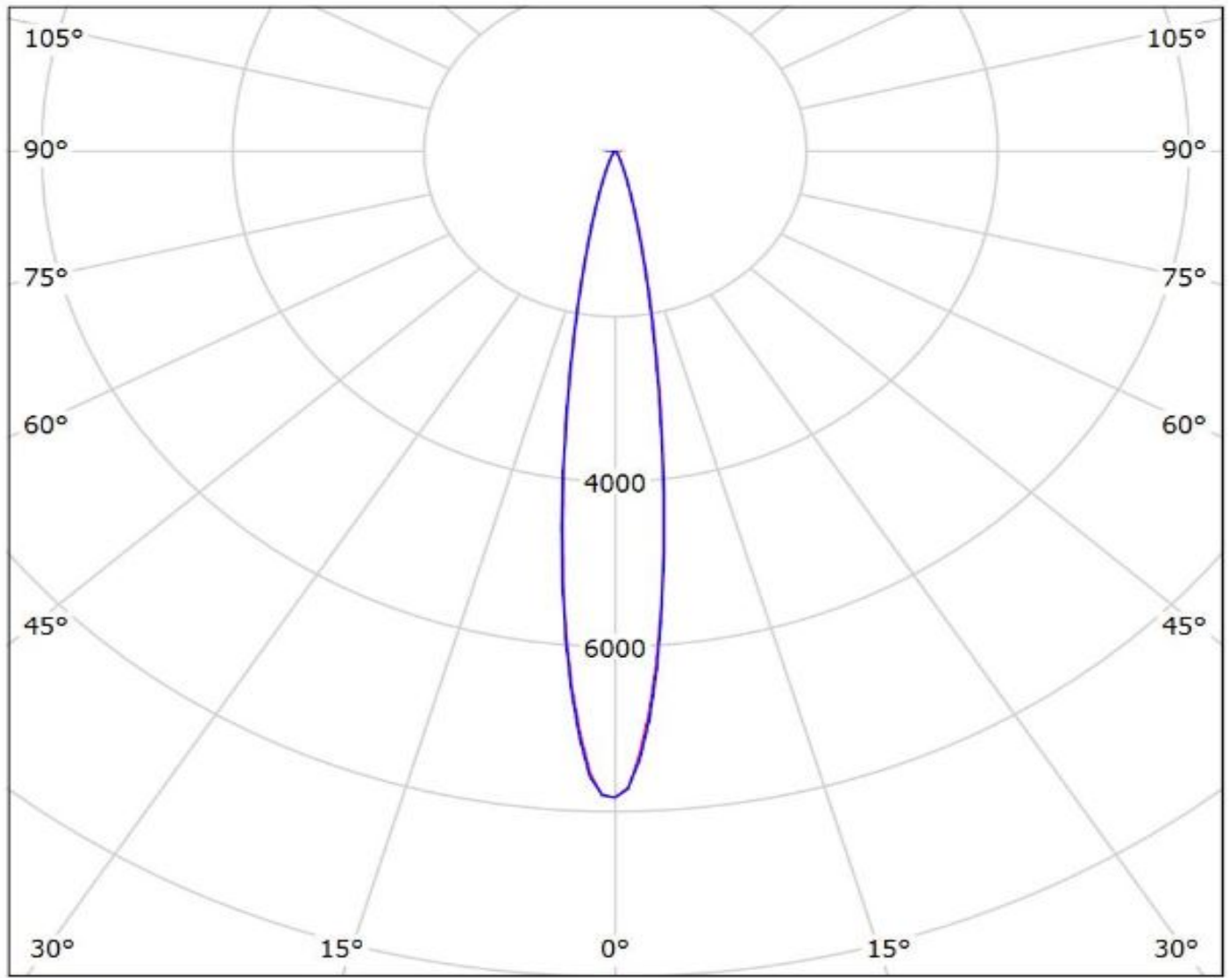

cd/klm

— C0 - C180

— C90 - C270

$\eta = 90\%$

Ledil CN13741_GERI-RZ_(XM-L_RGBW) / LDC (Polar)

Luminaire: Ledil CN13741_GERI-RZ_(XM-L_RGBW)

Lamps: 1 x CREE_XM-L_RGBW_(XMLCTW-A0-0000-00C3AAAA1)

_215.885lm@250mA_P=2.7W_I=0.25A

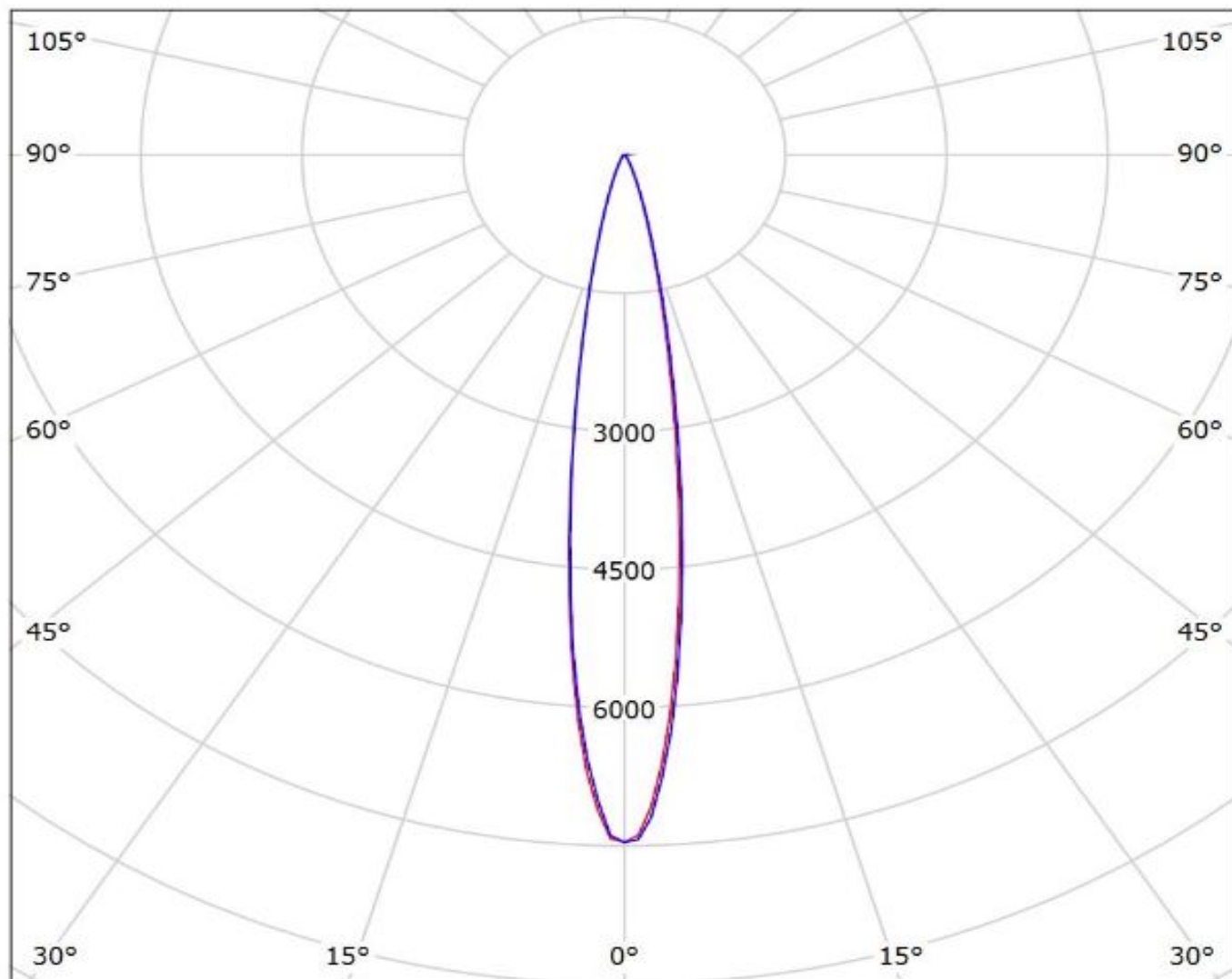

cd/klm

— C0 - C180

— C90 - C270

$\eta = 90\%$

Luminaire: Ledil FCN13741_GERI-RZ_(XQE_HI_RGBW)

Lamps: 1 x Cree_XQE_HI_RGBW_212.518lm@250mA_P=2.7397W_I=0.250A

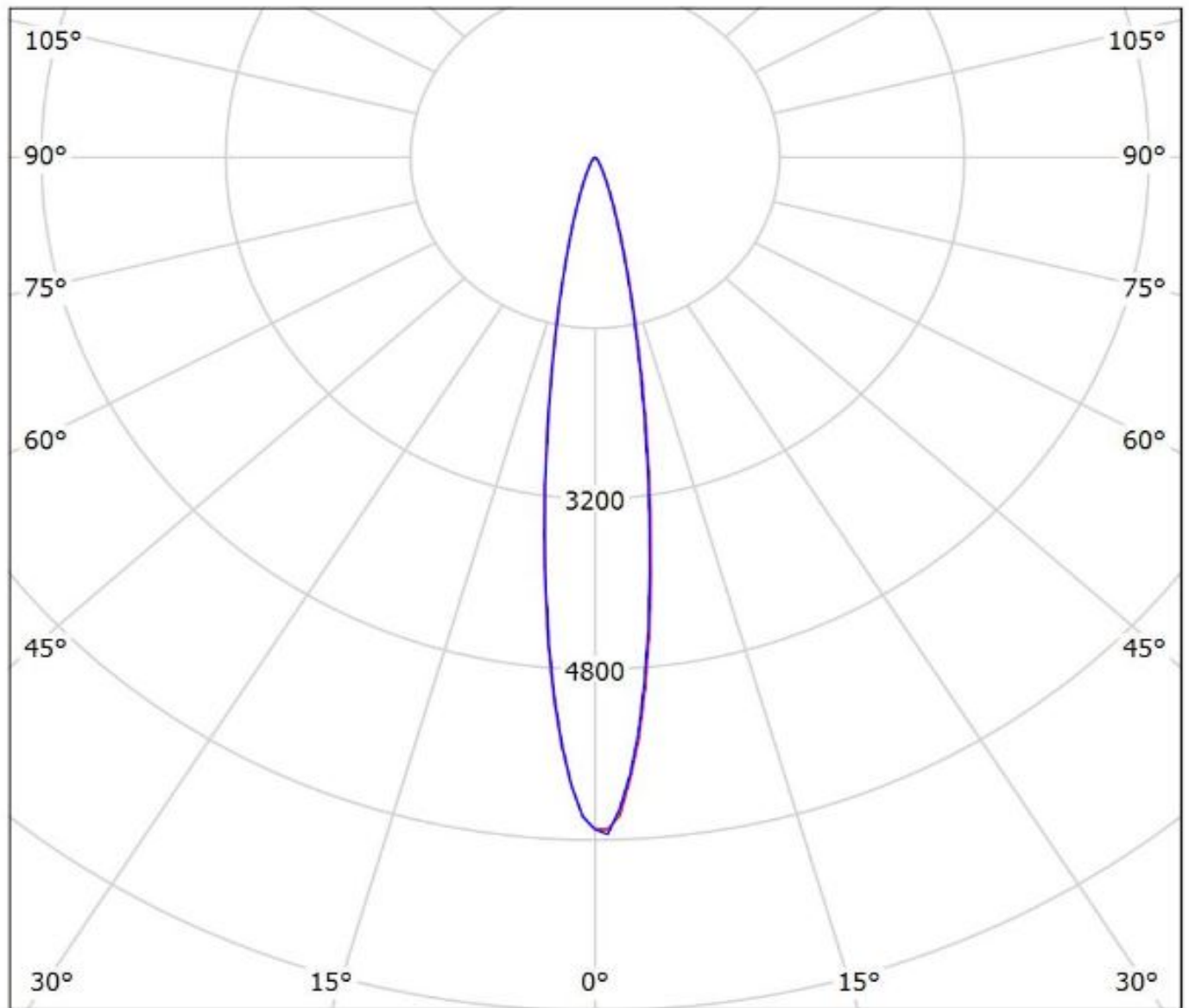

cd/klm

— C0 - C180

— C90 - C270

η = 85%

Luminaire: Ledil FCN13741_GERI-RZ_(XQ-E_HD_RGBW)

Lamps: 1 x Cree_XQ-E_HD_RGBW_233.24lm@250mA_P=2.7265W_I=0.250A

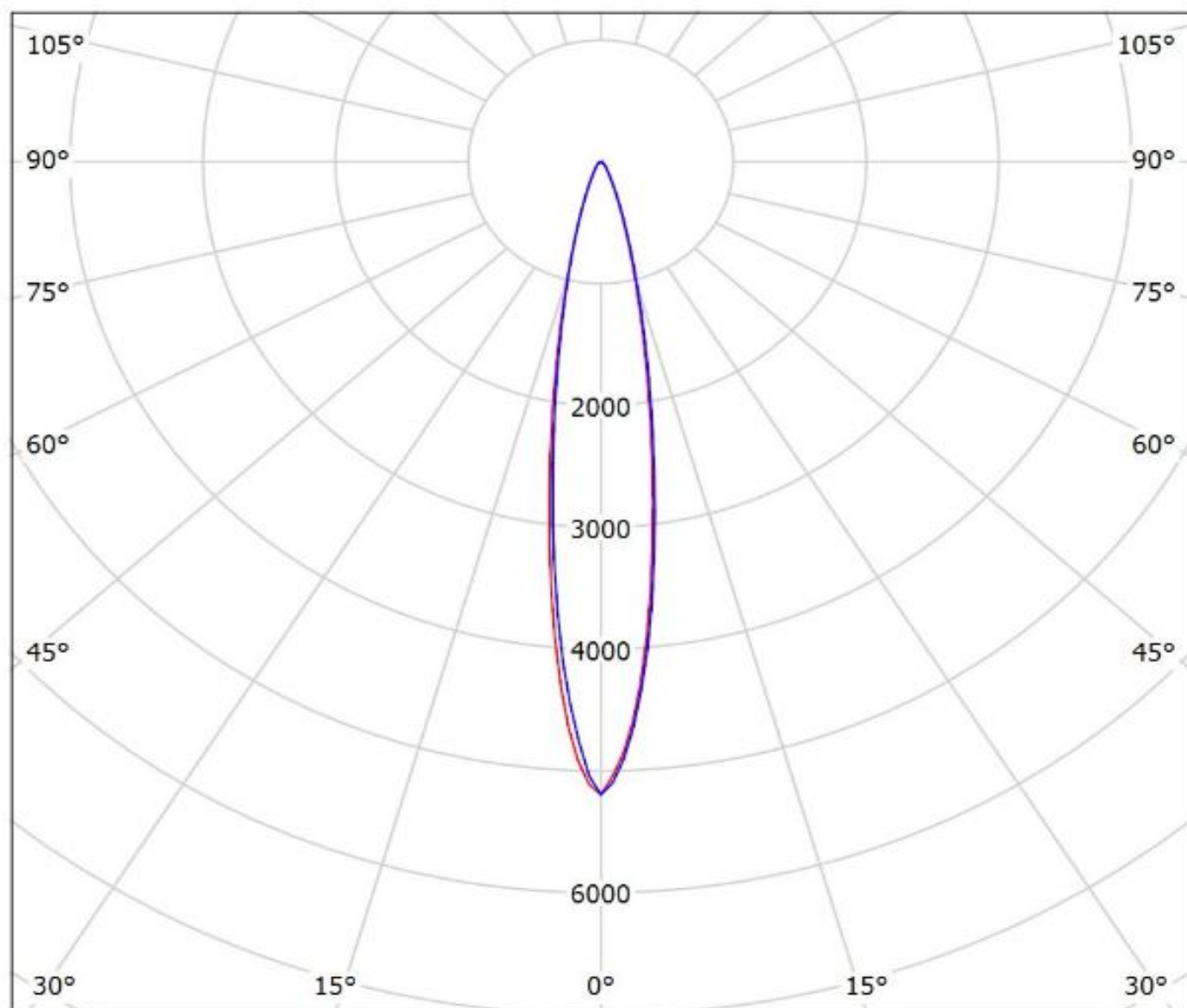

cd/klm

— C0 - C180

— C90 - C270

$\eta = 86\%$

Luminaire: Ledil FCN13741_GERI-RZ_(XP-G3)

Lamps: 1 x Cree_XP-G3_109.458lm@250mA_P=0.738275W_I=0.250A

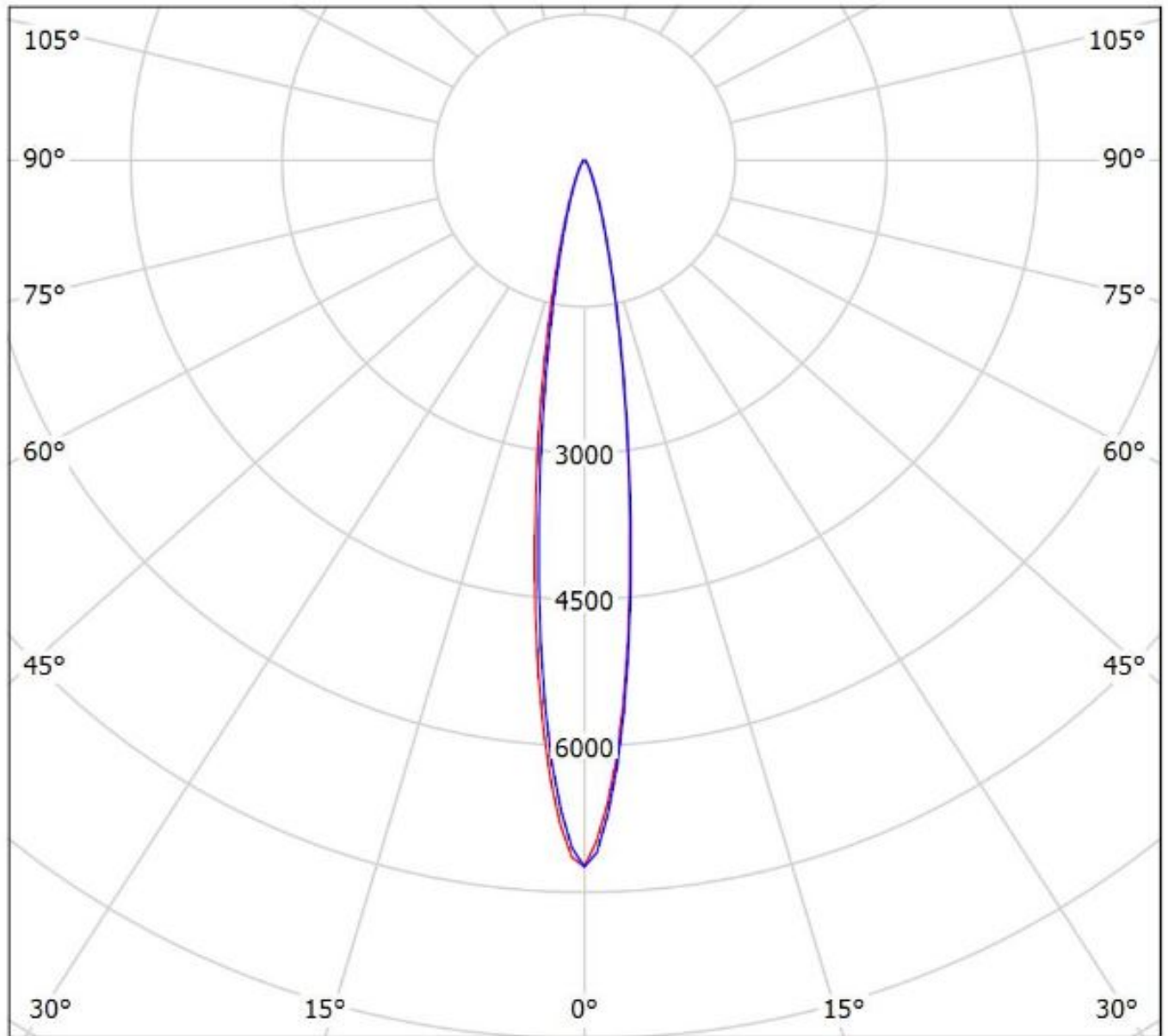

cd/klm

— C0 - C180

— C90 - C270

$\eta = 85\%$

Luminaire: Ledil FCN13741_GERI-RZ_(XT-E)

Lamps: 1 x Cree_XT-E_(XTEAWT-0-2A0-R30-FB-0001)_100.346lm@250mA_P=0.795125W_I=0.250A

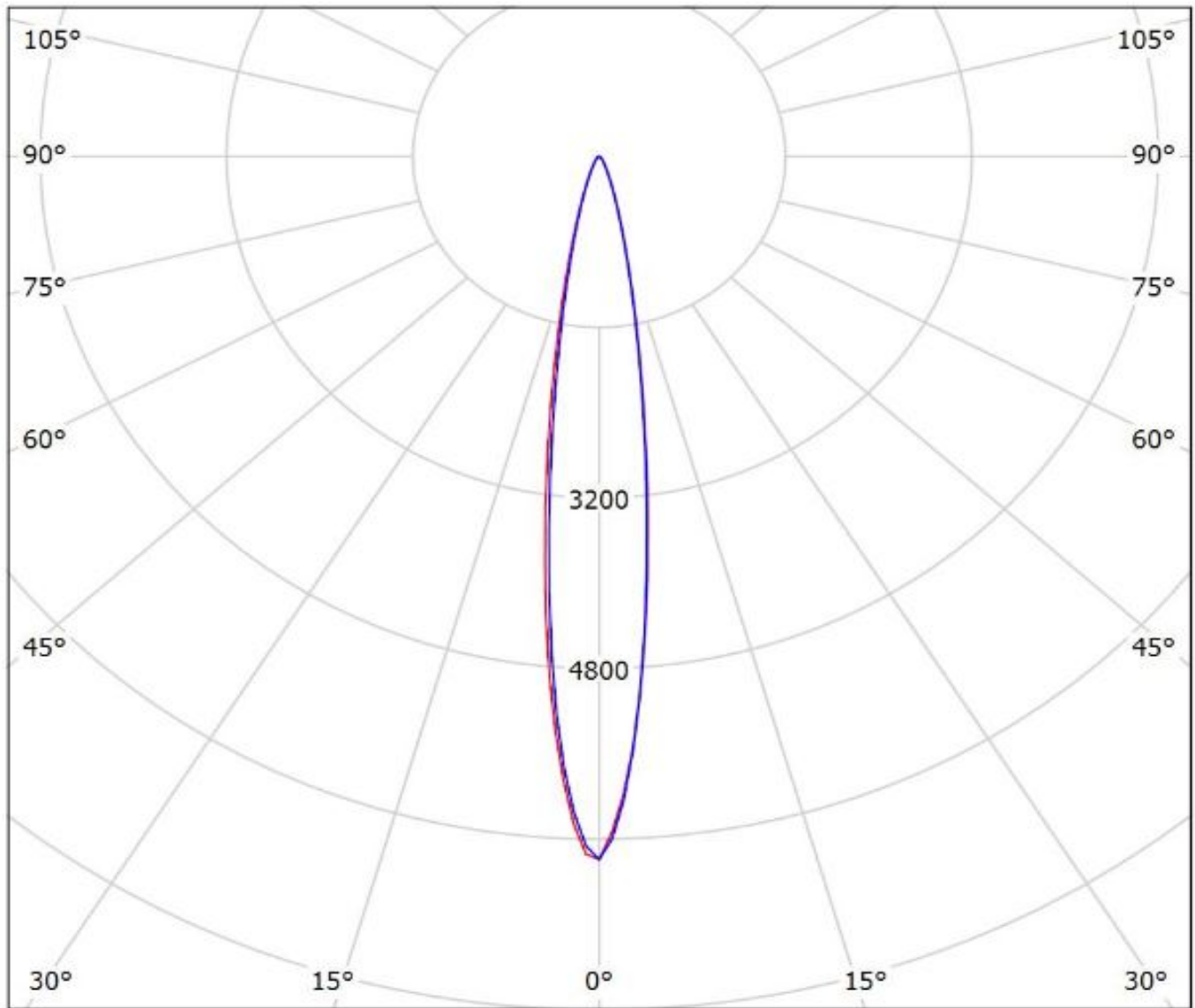

cd/klm

— C0 - C180

— C90 - C270

$\eta = 84\%$

Ledil CN13741_GERI-RZ_(LUXEON_Z_RGBW) / LDC (Polar)

Luminaire: Ledil CN13741_GERI-RZ_(LUXEON_Z_RGBW)

Lamps: 1 x LUXEON_Z_RGBW_165.276lm@250mA_P=2.6W_I=0.25A

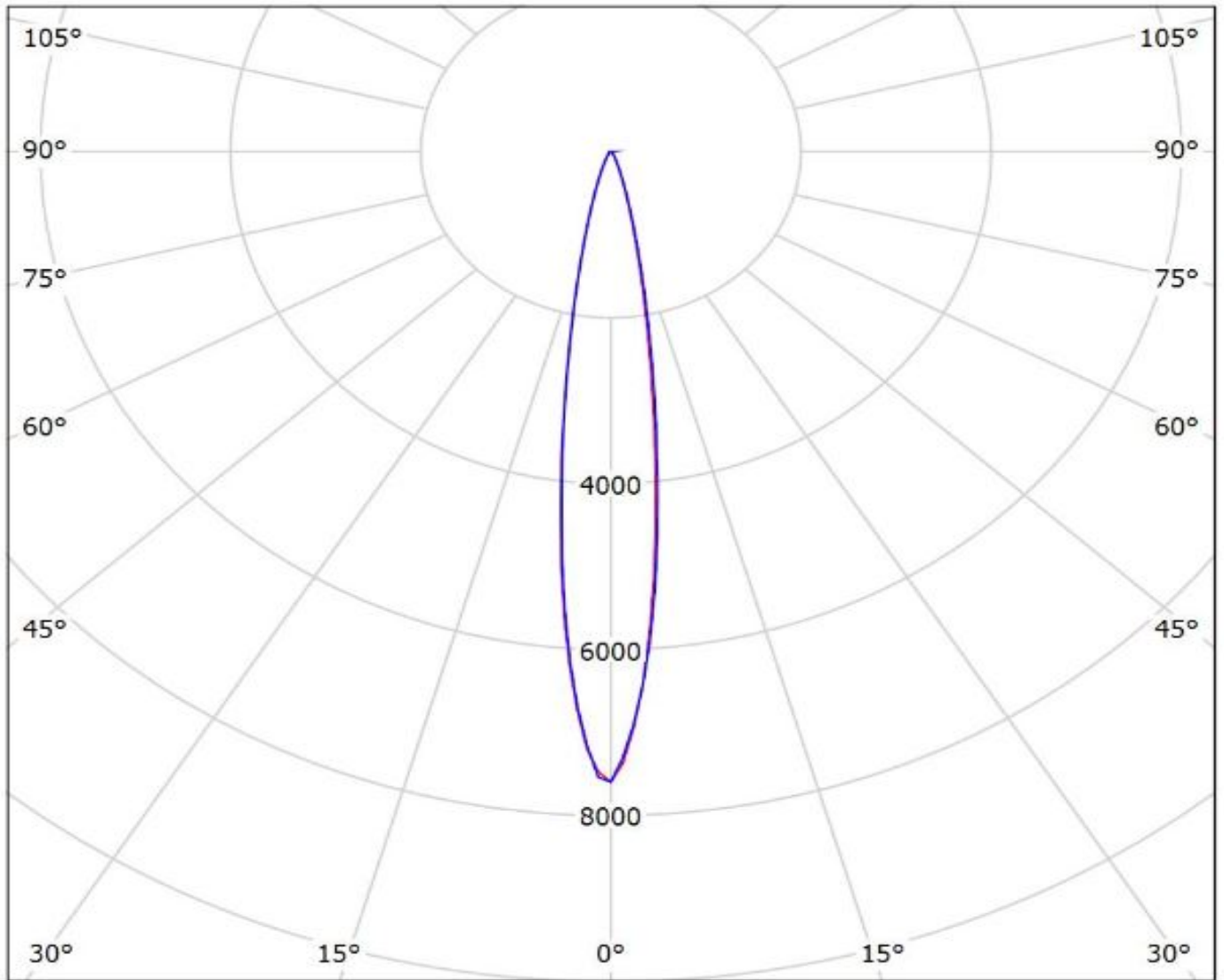

cd/klm

— C0 - C180 — C90 - C270

$\eta = 89\%$

Luminaire: LEDiL Oy FCN13741_GERI-RZ_(Luxeon_C_RGBW)
Lamps: 1 x Luxeon_C_RGBW_208.984lm@250mA_P=2.5474W_I=0.250A

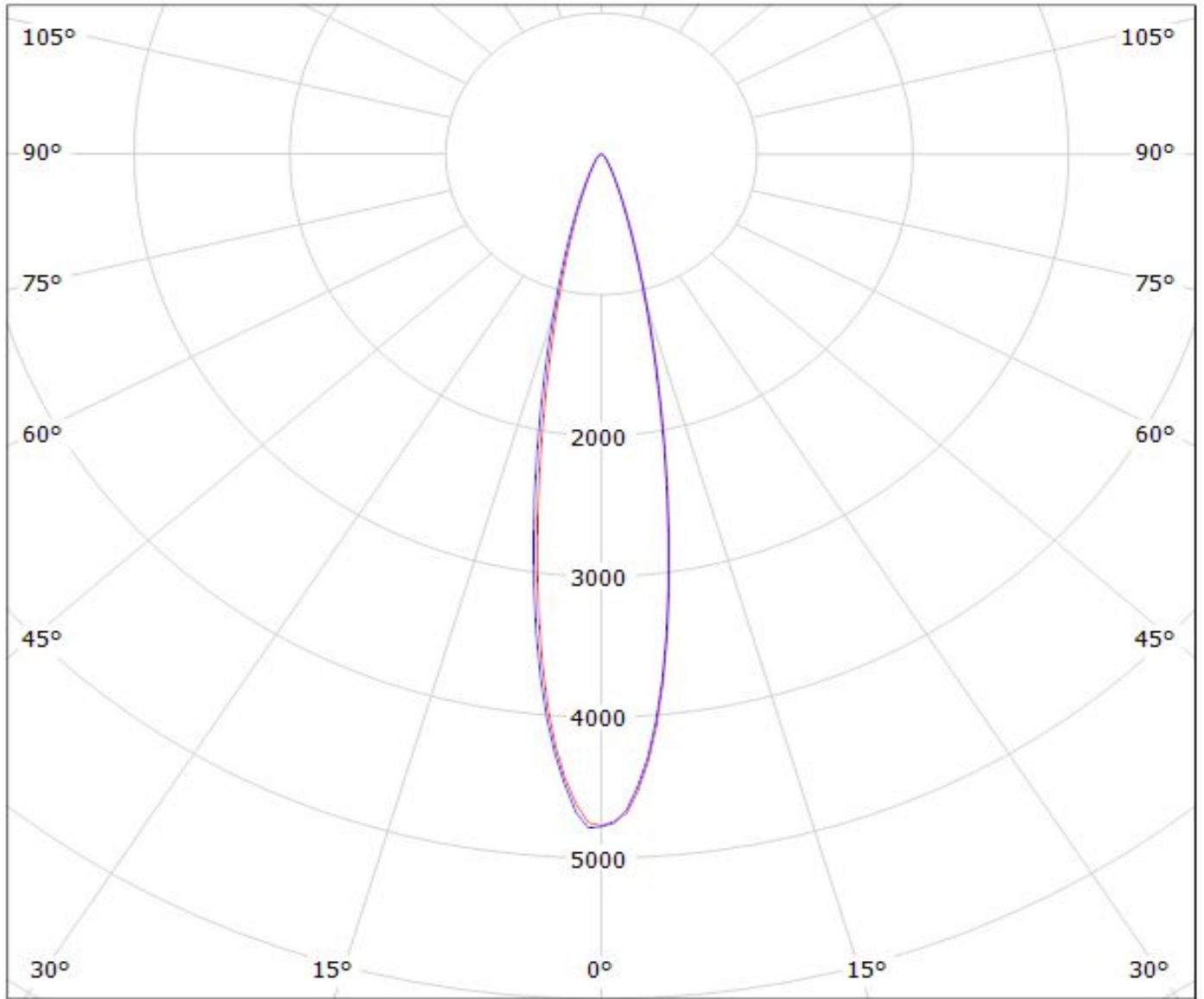

cd/klm

— C0 - C180 — C90 - C270

$\eta = 89\%$

Ledil CN13741_GERI-RZ_(OSTAR-SMT_RGB) / LDC (Polar)

Luminaire: Ledil CN13741_GERI-RZ_(OSTAR-SMT_RGB)

Lamps: 1 x OSRAM_OSTAR-SMT_RGB_168.879lm@250mA_P=3W_I=0.25A

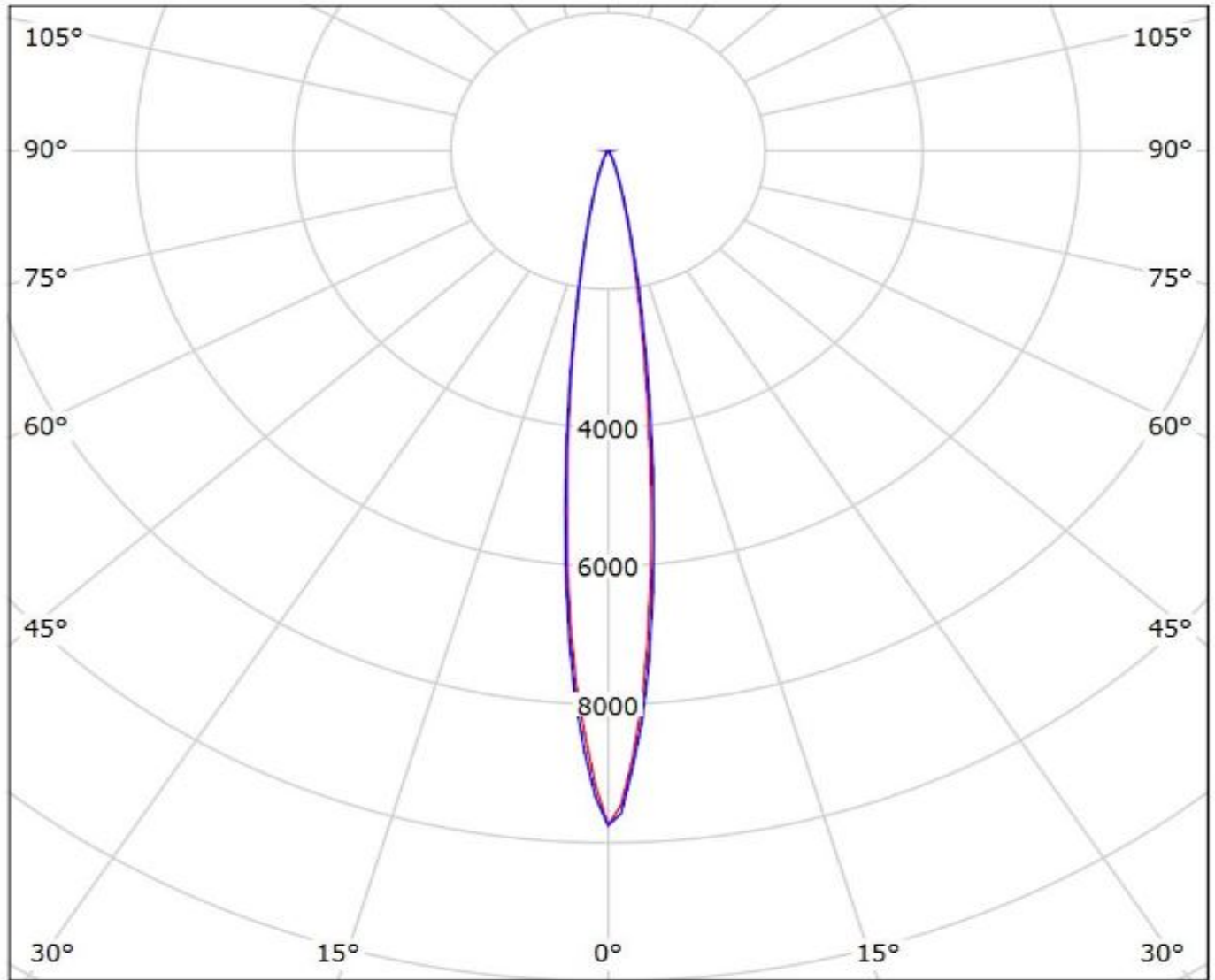

cd/klm

— C0 - C180 — C90 - C270

$\eta = 89\%$

Ledil CN13741_GERI-RZ_(F50360_RGB) / LDC (Polar)

Luminaire: Ledil CN13741_GERI-RZ_(F50360_RGB)

Lamps: 1 x SEOUL_F50360_RGB_(-01_QLSRBH)_57.1364lm@250mA_P=2.1W_I=0.25A

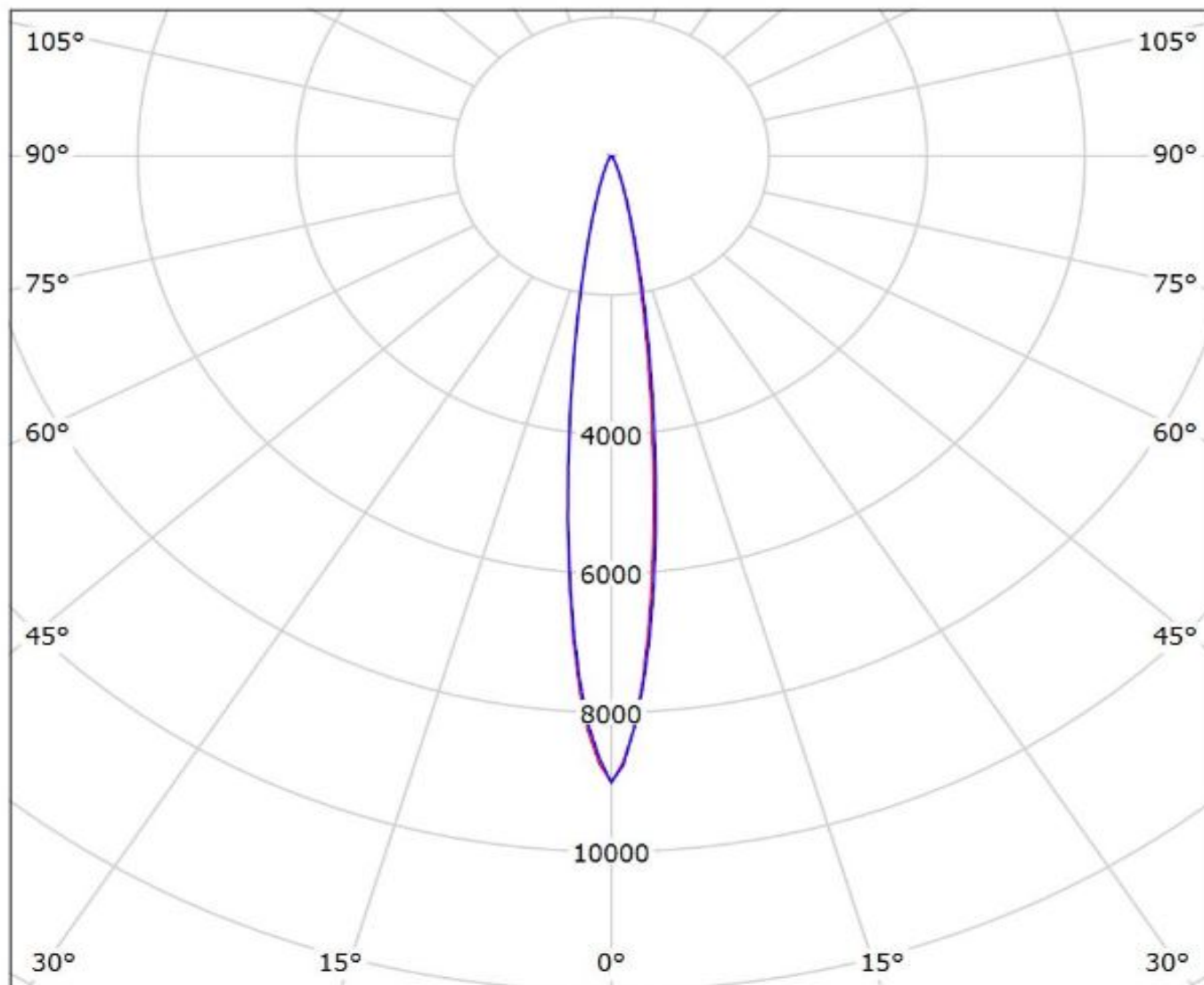

cd/klm

— C0 - C180

— C90 - C270

$\eta = 90\%$

NOTE: The typical divergence will be changed by different color, chip size and chip position tolerance. The typical total divergence is the full angle measured where the luminous intensity is half of the peak value.