

SM23B182K402A

KPS SM SMD Indust X7R HV, Ceramic, 1800 pF, 10%, 4000 VDC, X7R, SMD, Fixed, High Volt, Low ESR, Leaded, Industrial, SM23

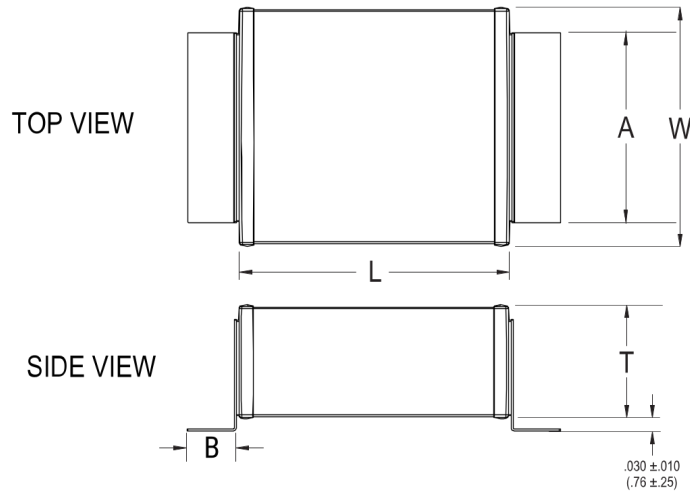

Click [here](#) for the 3D model.

Dimensions	
Chip Size	SM23
L	8.89mm +/-0.762mm
W	7.62mm +/-0.762mm
T	5.588mm MAX
A	5.08mm MAX
B	2.54mm +/-0.508mm

Packaging Specifications	
Packaging	Tray
Packaging Quantity	50

General Information	
Series	KPS SM SMD Indust X7R HV
Style	SMD Chip
Description	SMD, Fixed, High Volt, Low ESR, Leaded, Industrial
Features	High Voltage, Low ESR, Industrial Grade
RoHS	With Exemptions
REACH	SVHC (Pb - CAS 7439-92-1)
Termination	Silver
Marking	No
AEC-Q200	No
Shelf Life	78 Weeks
MSL	1

Specifications	
Capacitance	1800 pF
Capacitance Tolerance	10%
Voltage DC	4000 VDC
Dielectric Withstanding Voltage	4800 VDC
Temperature Range	-55/+125°C
Temperature Coefficient	X7R
Dissipation Factor	2.5%
Insulation Resistance	100 GOhms
Quality Factor	3

Statements of suitability for certain applications are based on our knowledge of typical operating conditions for such applications, but are not intended to constitute - and we specifically disclaim - any warranty concerning suitability for a specific customer application or use. This information is intended for use only by customers who have the requisite experience and capability to determine the correct products for their application. Any technical advice inferred from this information or otherwise provided by us with reference to the use of our products is given gratis, and we assume no obligation or liability for the advice given or results obtained.