

# Solid State Relays DC Switching

## Types RGC1D Solid State Contactor RGS1D Solid State Relay



- IGBT power semiconductor
- 17.5 mm product width, with or without integrated heatsink
- Rated Operational voltage: 1000 VDC
- Rated Operational current: Up to 25 ADC
- Control voltage: 4.5-32 VDC
- Input polarity protection
- Removable IP20 cover
- Integrated free-wheeling diode for output protection
- Max. transient peak voltage: 1200 V



### Product Description

This product series is mainly intended to switch a string of photovoltaic panels with a maximum string voltage of 1000 VDC and up to 25 ADC in only 17.5 mm width. It may be used in other DC application as well.

the IGBT at the output is protected against back voltage with an integrated free-wheeling diode.

RGS1D is the panel mount version while the RGC1D has an integrated heatsink.

The control port is protected against reverse polarity while

Specifications are stated at 25°C unless otherwise noted.

### Ordering Key RGC 1 D 1000 D 15 K K E

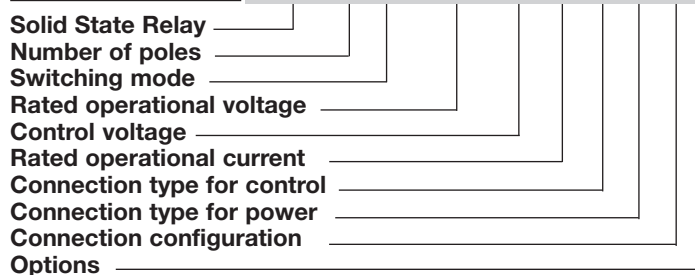

### Ordering Key

1-Phase DC switching	Rated Voltage	Control Voltage	Rated Current	Connection Control	Connection Power	Connection Configuration
RGC1D: Contactor RGS1D: SSR	1000: 1000 VDC	D: 4.5 - 32 VDC	15: 15 ADC 25: 25 ADC	K: Screw	K: Screw	E: Contactor

### Selection Guide (Integrated heatsink)

Rated Output voltage	Max. transient peak voltage	Control Voltage	Rated Operational Current @40°C
1000 VDC	1200 Vp	4.5 - 32 VDC	15 ADC RGC1D1000D15KKE

### Selection Guide (Panel-mount Solid State Relay)

Rated Output voltage	Max. transient peak voltage	Control Voltage	Rated Operational Current
1000 VDC	1200 Vp	4.5 - 32 VDC	15 ADC RGS1D1000D15KKE
			25 ADC RGS1D1000D25KKE RGS1D1000D25KKEHT <sup>1</sup>

1: Option with attached thermal pad.

### Output Voltage Specifications

Operational Voltage Range IEC <sup>2</sup>	24 - 1000 VDC
UL508 <sup>2</sup>	24 - 600 VDC
Maximum transient peak voltage	1200 VDC
Maximum Onstate Voltage Drop	1.6 VDC

2: -15% on lower voltage limit

\* Applicable only for RGC1D1000D15KKE

### General Specifications

Protection	IP20
Control input status	continuously ON Green LED, when control input is applied
Pollution degree	2 (non-conductive pollution with possibilities of condensation)
Over-voltage category	III (fixed installations)
Isolation	
Input to Output	4 kVrms
Input & Output to Case	4 kVrms

## Input Specifications (@ 60°C)

Control voltage range	4.5 - 32 VDC	Maximum response time pick-up	Refer to Time characteristics
Pick-up voltage <sup>3</sup>	4 VDC	Maximum response time drop-out	Refer to Time characteristics
Drop-out voltage	1 VDC	Input current	See diagram below
Maximum Reverse voltage	32 VDC		

Note: Ideally control should be switched with a contactless switch (eg: open collector)  
 3. Pickup voltage should be minimum 6VDC for EMC conformance.

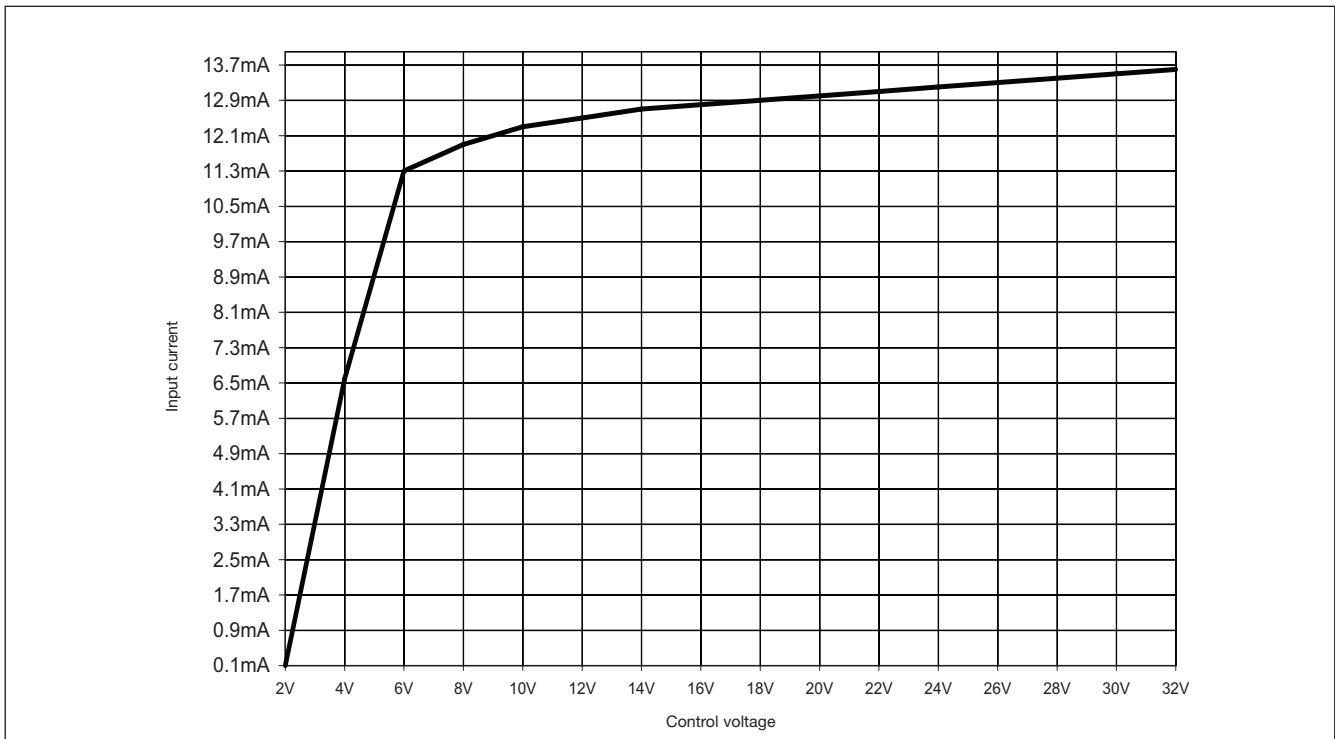

## Time Characteristics

CHARACTERISTICS	
Turn on time (ton)	50µs
Turn on delay (tdon)	50µs
Turn off time (toff)	200µs
Turn off delay (tdoff)	50µs
Switching Frequency	20Hz

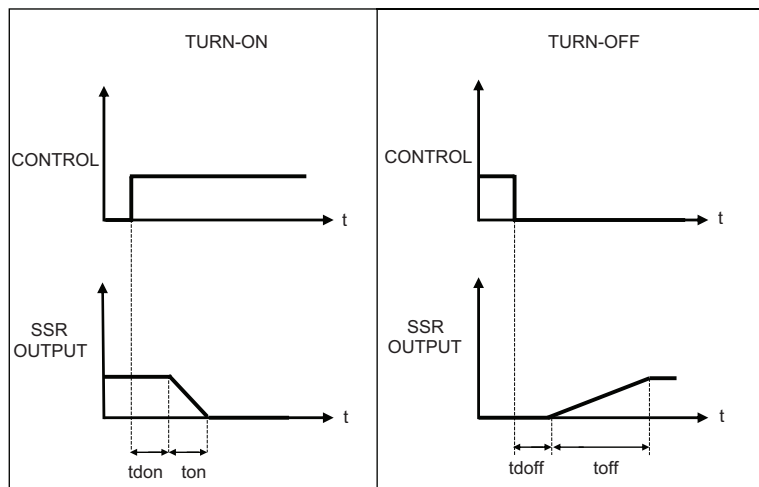

## Current Derating for RGC1D

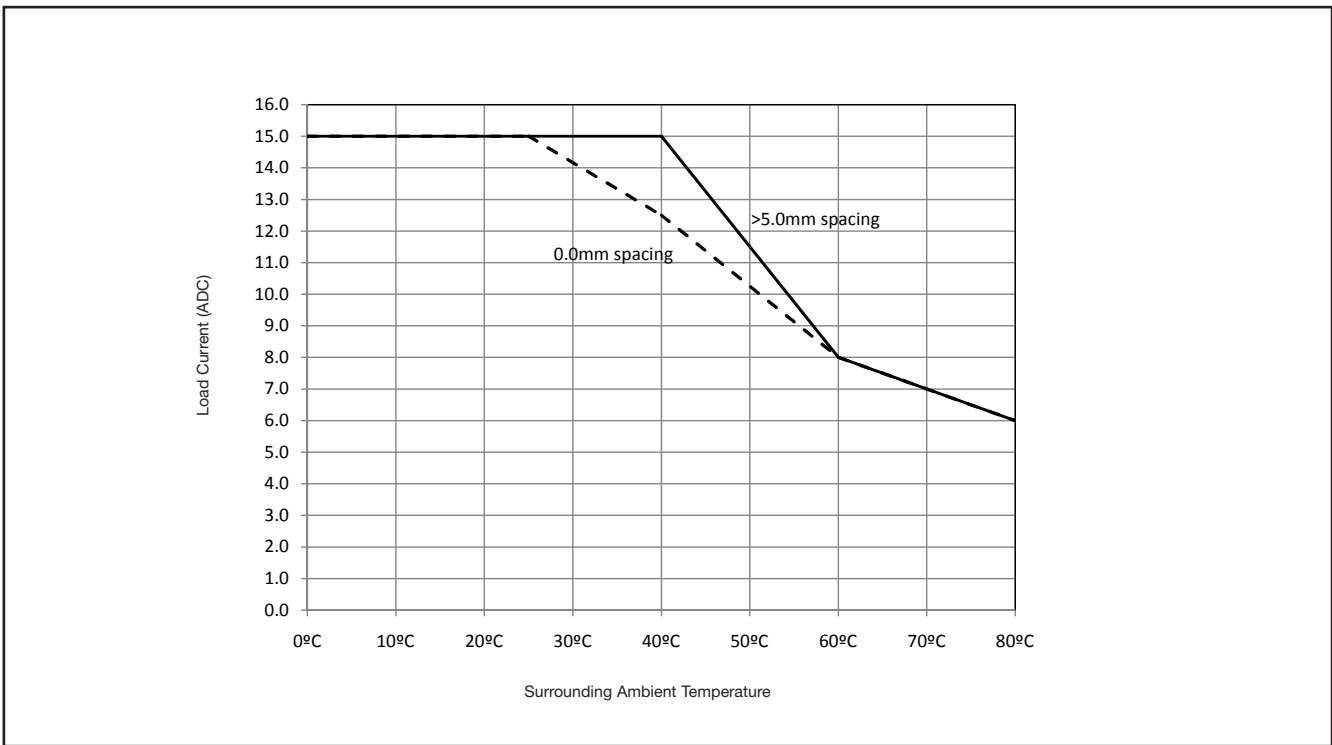

## Output Specifications (@ 40°C unless otherwise specified)

		RGC1D..15	RGS1D..15	RGS1D..25
Current Rating	DC-1 @ 60°C DC-1 @ 40°C	8 ADC 15 ADC	15 ADC	25 ADC
Maximum offstate leakage at rated voltage		1.5 mA	1.5 mA	1.5 mA
Min. operational current		20 mADC	20 mADC	20 mADC
Maximum Transient Surge Current (t=10 μs)		200 ADC	200 ADC	200 ADC

## Agency Approvals and Conformances

RGC1D

UL508 Listed (E172877)  
cUL Listed (E172877)

RGS1D

UL508 Recognised (E172877)  
CSA (204075)



## Electromagnetic Compatibility

<b>EMC Immunity</b>	IEC/EN 61000-6-2
<b>Electrostatic Discharge (ESD) Immunity</b>	IEC/EN 61000-4-2
Air discharge, 8 kV	Performance Criteria 1
Air discharge, 16 kV	Performance Criteria 2
Contact, 4 kV	Performance Criteria 1
Contact, 8 kV	Performance Criteria 2
<b>Electrical Fast Transient (Burst) Immunity</b>	IEC/EN 61000-4-4
Output: 4 kV, 5 kHz /100 kHz	Performance Criteria 2
Input: 1 kV, 5 kHz / 100 kHz	Performance Criteria 1
<b>Electrical Surge Immunity</b>	IEC/EN 61000-4-5
Output, line to line, 1 kV	Performance Criteria 1
Output, line to earth, 2 kV	Performance Criteria 1
Input, line to line, 1 kV	Performance Criteria 1
Input, line to earth, 2 kV	Performance Criteria 1
<b>EMC Emission</b>	IEC/EN 61000-6-3
<b>Radio Interference field emission (Radiated) 30 - 1000 MHz</b>	IEC/EN 55011 Class B

<b>Radiated Radio Frequency Immunity</b>	IEC/EN 61000-4-3
10 V/m, 80 - 1000 MHz	Performance Criteria 1
10 V/m, 1.0 - 2.7 GHz	Performance Criteria 1
<b>Conducted Radio Frequency Immunity</b>	IEC/EN 61000-4-6
10 V/m, 0.15 - 80 MHz	Performance Criteria 1
<b>Voltage Dips, Short Interruptions and Voltage Variations Immunity tests</b>	IEC/EN 61000-4-11
0% @ 5000 ms	Performance Criteria 2
40% @ 200 ms	Performance Criteria 2
60% @ 10, 30, 100, 300, 1000 ms	Performance Criteria 2
<b>Voltage Dips, Short Interruptions and Voltage Variations on Input Lines Immunity tests</b>	IEC/EN 61000-4-29
0% @ 1, 3, 10, 30, 100, 300, 1000 ms	Performance Criteria 2
30% @ 10, 30, 100, 300, 1000 ms	Performance Criteria 2
70% @ 10, 30, 100, 300, 1000 ms	Performance Criteria 2
-20% @ 10, 30, 100, 300, 1000ms, 3s, 10s	Performance Criteria 2
+20% @ 10, 30, 100, 300, 1000ms, 3s, 10s	Performance Criteria 2
<b>Radio Interference Voltage Emission (Conducted) 0.15 - 30 MHz</b>	IEC/EN 55011 Class B

## Environmental Specifications

Operating Temperature	-40°C to 80°C (-40°F to +176°F)
Storage Temperature	-40°C to 100°C (-40°F to +212°F)
EU RoHS compliant	Yes
China RoHS compliant	Refer to Environmental Information (page 10)
Impact resistance (EN50155, EN61373)	15/11 g/ms
Vibration resistance (2-100Hz, IEC 60068-2-6, EN50155, EN61373)	2 g per axis (5 g for RGS)
Relative humidity	95% non-condensing @ 40°C
UL flammability rating (housing)	UL 94 V0

## Connection Diagram

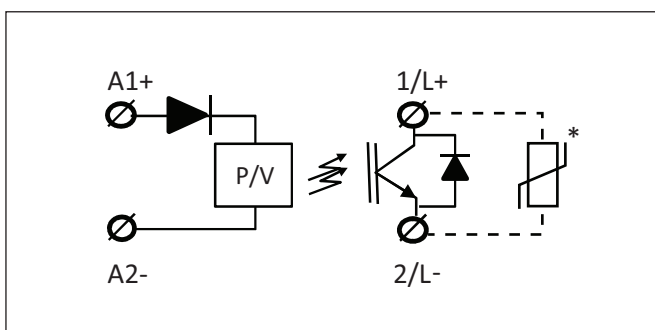

\* varistor not included

## Terminal Layout

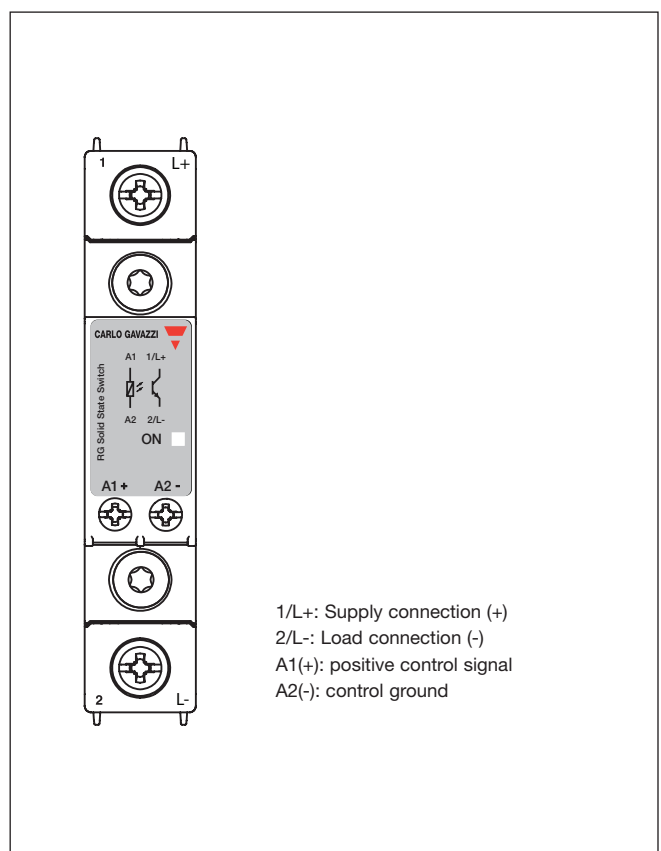

1/L+: Supply connection (+)  
 2/L-: Load connection (-)  
 A1(+): positive control signal  
 A2(-): control ground

## Dimensions

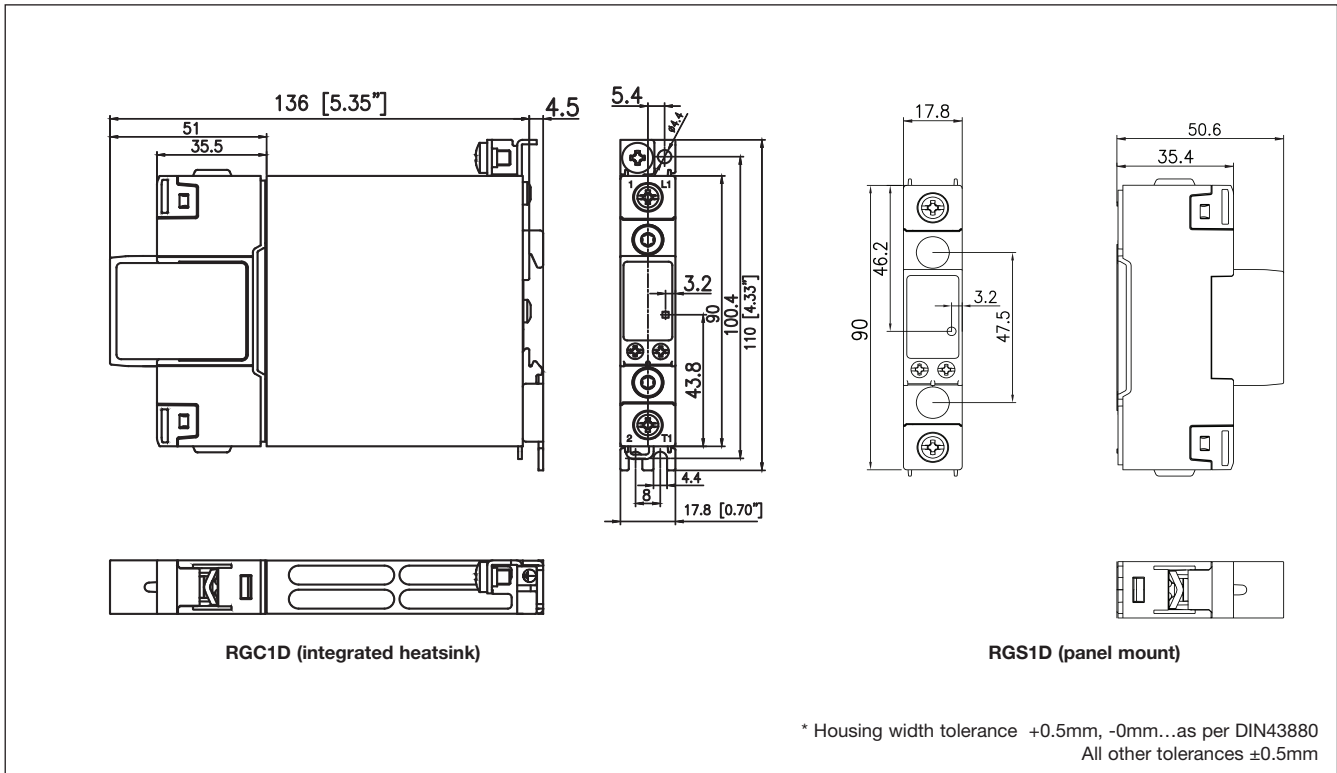

\* Housing width tolerance +0.5mm, -0mm...as per DIN43880  
All other tolerances ±0.5mm

All dimensions in mm

## Connection Specifications

### POWER CONNECTIONS: 1/L+, 2 /L-

Use 75°C copper (Cu) conductors  
Torque specifications

IEC: 1.5 - 2.0 Nm (13.3 - 17.7 lb-in)  
UL: 2.0 Nm (17.7 lb-in)  
M4, Pozidriv 2  
Stripping Length (X) = 12 mm

#### Rigid (Solid & Stranded)

UL/ CSA rated data

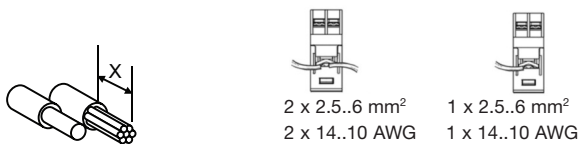

#### Flexible with end sleeve

2 x 2.5..6 mm<sup>2</sup> 1 x 2.5..6 mm<sup>2</sup>  
2 x 14..10 AWG 1 x 14..10 AWG



2 x 1.0..2.5 mm<sup>2</sup>  
2 x 2.5..4 mm<sup>2</sup>  
2 x 14..12 AWG 1 x 1.0..4 mm<sup>2</sup>  
2 x 18..14 AWG 1 x 18..12 AWG

#### Flexible without end sleeve

2 x 1.0..2.5 mm<sup>2</sup>  
2 x 2.5..6 mm<sup>2</sup>  
2 x 2.5..6 mm<sup>2</sup> 1 x 1.0..6 mm<sup>2</sup>  
2 x 18..14 AWG 1 x 18..10 AWG



#### Aperture for termination lug

12.3 mm

### CONTROL CONNECTIONS: A1(+), A2(-)

Use 60/75°C copper (Cu) conductors  
Torque specifications

IEC: 0.5 - 0.6 Nm (4.4 - 5.3 lb-in)  
UL: 0.5Nm (4.4 lb-in)  
M3, Pozidriv 1  
Stripping Length (X) = 8 mm

#### Rigid (Solid & Stranded)

UL/ CSA rated data

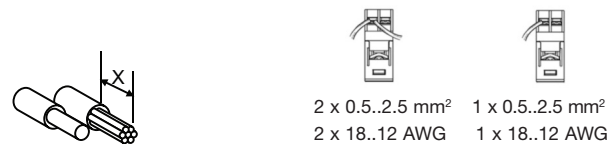

#### Flexible with end sleeve

2 x 0.5..2.5 mm<sup>2</sup> 1 x 0.5..2.5 mm<sup>2</sup>  
2 x 18..12 AWG 1 x 18..12 AWG



2 x 0.5..2.5 mm<sup>2</sup> 1 x 0.5..2.5 mm<sup>2</sup>  
2 x 18..12 AWG 1 x 18..12 AWG

#### Protective Earth Connection (RGC)



M5, 1.5 Nm (13.3 in-lb)  
(not provided with SSR)

Note: M5 PE screw not provided with SSR. PE connection required when product is intended to be used in Class 1 applications according to EN/IEC 61140.

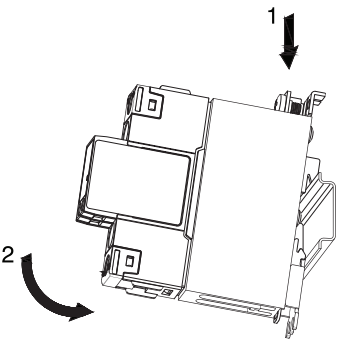

# Installation Instructions for RGC1D



1 ↓

2 ↻

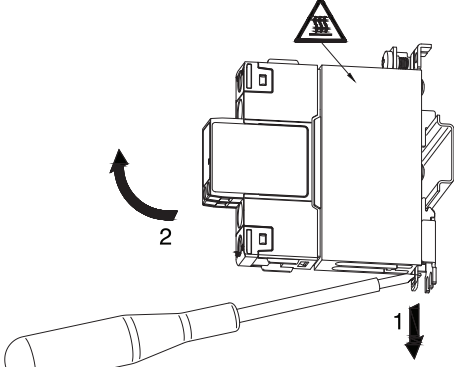
Mounting on DIN rail



2 ↻

1 ↓

Dismounting from DIN rail

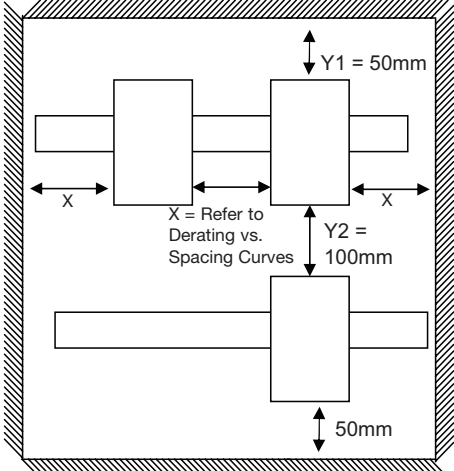

Y1 = 50mm

X

X = Refer to Derating vs. Spacing Curves

Y2 = 100mm

50mm

Detailed description: The diagram shows the RGC1D device being mounted onto a DIN rail. Step 1 is a downward arrow indicating the device is pushed onto the rail. Step 2 is a curved arrow indicating the device is rotated to lock onto the rail. The dismounting process is the reverse: step 1 is a downward arrow indicating the device is lifted off the rail, and step 2 is a curved arrow indicating it is rotated back to its original position. A photograph shows the physical device with its mounting tabs. The spacing diagram shows two devices on a rail with dimensions: Y1 = 50mm (height of the rail), Y2 = 100mm (height of the device), and X (spacing between devices, with a note to refer to derating vs. spacing curves). A 50mm dimension is also shown for the bottom part of the device.

## Output Power Dissipation

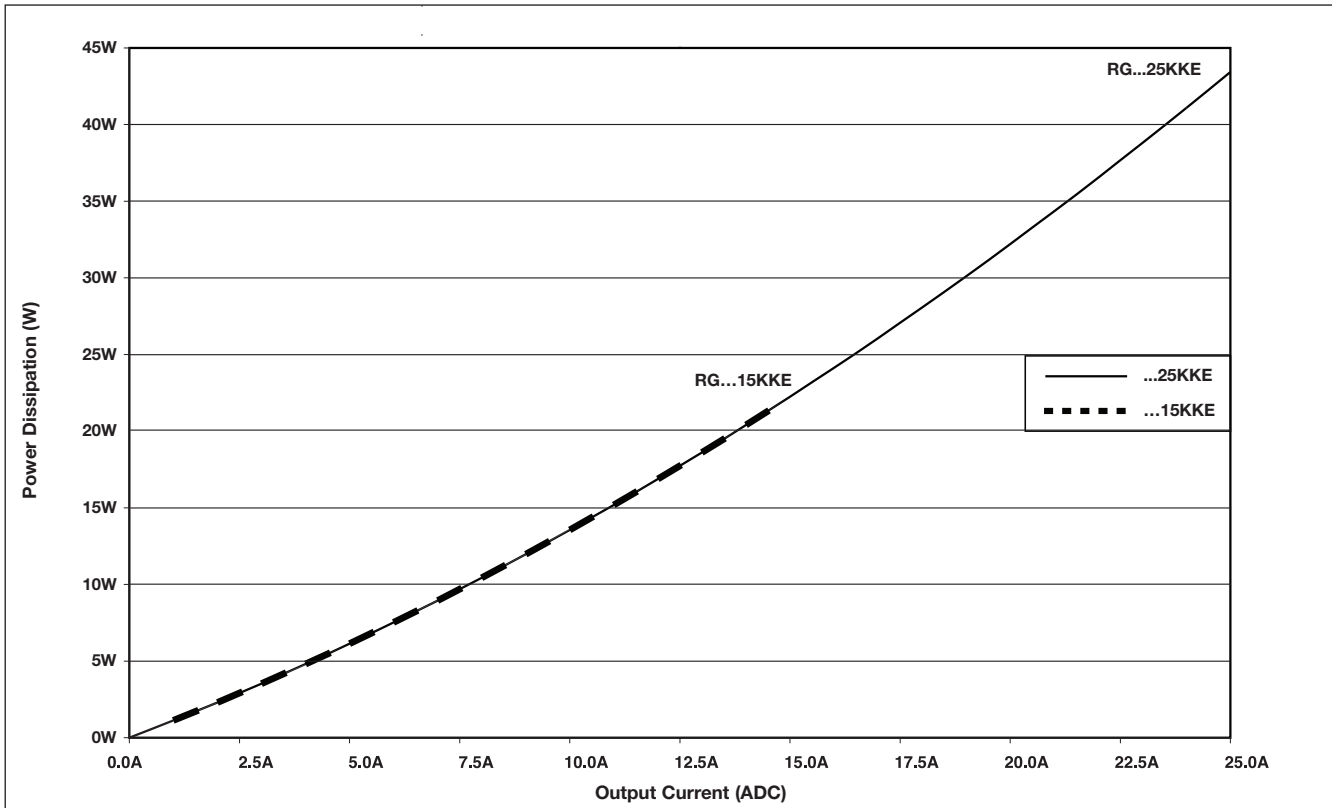

## Mounting Instructions for RGS1D

Thermal stress will reduce the lifetime of the SSR. Therefore it is necessary to select the appropriate heatsinks, taking into account the surrounding temperature, load current and the duty cycle.

A fine layer of thermally conductive silicone paste must be applied to the back of the SSR. RGS should be mounted on the heatsink with two M5 x 30 mm screws. Gradually tighten each screw (alternating between the two) until both are tightened with a torque of 0.75 Nm. Then tighten both screws to their final mounting torque of 1.5 Nm.

In case of a thermal pad attached to the back of the SSR, no thermal paste is required. The RGS is gradually tightened (alternating between the 2 screws) to a maximum torque of 1.5 Nm.



# Heatsink Selection for RGS1D

## RGS1D..15

Load current [A]	Thermal resistance [°C/W]						
	20	30	40	50	60	70	80
15	3.60	3.15	2.70	2.25	1.80	1.35	0.90
13.5	4.10	3.59	3.08	2.56	2.05	1.54	1.03
12	4.74	4.15	3.56	2.96	2.37	1.78	1.19
10.5	5.57	4.87	4.18	3.48	2.79	2.09	1.39
9	6.69	5.85	5.01	4.18	3.34	2.51	1.67
7.5	8.26	7.23	6.20	5.16	4.13	3.10	2.07
6	10.64	9.31	7.98	6.65	5.32	3.99	2.66
4.5	14.63	12.81	10.98	9.15	7.32	5.49	3.66
3	----	----	----	14.17	11.33	8.50	5.67
1.5	----	----	----	----	----	----	11.71

T<sub>A</sub>  
Ambient temp [°C]

## RGS1D..25

Load current [A]	Thermal resistance [°C/W]						
	20	30	40	50	60	70	80
25	1.82	1.59	1.36	1.13	0.90	0.67	0.44
22.5	2.12	1.86	1.59	1.33	1.06	0.80	0.53
20	2.48	2.17	1.86	1.55	1.24	0.93	0.62
17.5	2.96	2.59	2.22	1.85	1.48	1.11	0.74
15	3.60	3.15	2.70	2.25	1.80	1.35	0.90
12.5	4.51	3.95	3.38	2.82	2.26	1.69	1.13
10	5.90	5.17	4.43	3.69	2.95	2.21	1.48
7.5	8.26	7.23	6.20	5.16	4.13	3.10	2.07
5	13.03	11.41	9.78	8.15	6.52	4.89	3.26
2.5	----	----	----	----	13.75	10.31	6.87

T<sub>A</sub>  
Ambient temp [°C]

Maximum junction temperature	125°C
Heatsink temperature	100°C
Junction to case thermal resistance, R <sub>thjc</sub>	<0.36 °C/W
Case to heatsink thermal resistance, R <sub>thcs</sub> <sup>4</sup>	< 0.32 °C/W

Maximum junction temperature	125°C
Heatsink temperature	100°C
Junction to case thermal resistance, R <sub>thjc</sub>	<0.36 °C/W
Case to heatsink thermal resistance, R <sub>thcs</sub> <sup>4</sup>	< 0.32 °C/W

## RGS1D..25..HT (with attached thermal pad)

Load current [A]	Thermal resistance [°C/W]						
	20	30	40	50	60	70	80
25.0	1.16	0.93	0.70	0.47	0.24	--	--
22.5	1.53	1.26	1.00	0.73	0.47	0.20	--
20.0	2.00	1.69	1.38	1.07	0.76	0.45	0.14
17.5	2.62	2.25	1.88	1.51	1.14	0.77	0.40
15.0	3.46	3.01	2.56	2.11	1.66	1.21	0.76
12.5	4.51	3.95	3.38	2.82	2.26	1.69	1.13
10.0	5.90	5.17	4.43	3.69	2.95	2.21	1.48
7.5	8.26	7.23	6.20	5.16	4.13	3.10	2.07
5.0	13.03	11.41	9.78	8.15	6.52	4.89	3.26
2.5	---	---	---	---	13.75	10.31	6.87

T<sub>A</sub>  
Ambient temp [°C]

Maximum junction temperature	125°C
Heatsink temperature	100°C
Junction to case thermal resistance, R <sub>thjc</sub>	<0.36 °C/W
Case to heatsink thermal resistance, R <sub>thcs</sub>	< 0.90 °C/W

4. Thermal resistance case to heatsink values are applicable upon application of a fine layer of silicon based thermal paste HTS02S from electrolube between SSR and heatsink.



## Connection in Application

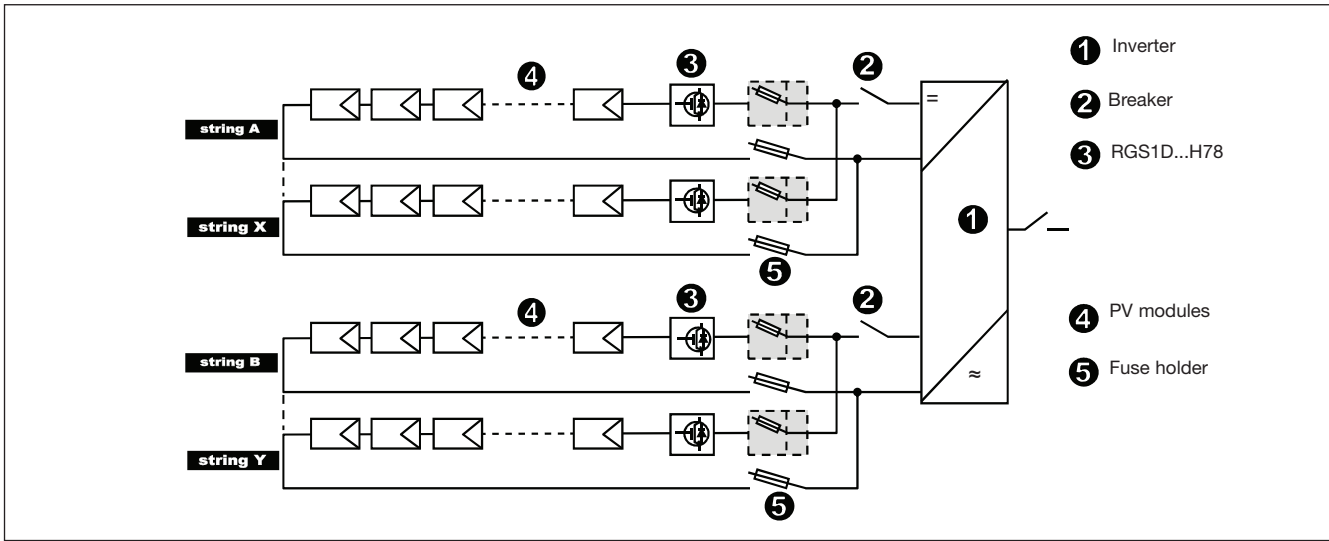

## Short Circuit Protection

Protection Co-ordination, Type 1:

Type 1 protection implies that after a short circuit, the device under test will no longer be in a functioning state.

In case, however the short circuit has to be interrupted. The fuse between enclosure and supply shall not open. The door or cover of the enclosure shall not be blown open. There shall be no damage to conductors or terminals and the conductors shall not separate from terminals. There shall be no breakage or cracking of insulating bases to the extent that the integrity of the mounting of live parts is impaired. Discharge of parts or any risk of fire shall not occur.

The product variants listed in the table hereunder are suitable for use on a circuit capable of delivering not more than 5,000ADC, 600Volts maximum when protected by fuses. Tests at 5,000A were performed with RK5 fuses, time delay; please refer to the table below for maximum allowed ampere rating of the fuse. Use fuses only.

### Co-ordination type 1 (UL508)

Part no.	Max. fuse size [A]	Class	Current [kA]	Voltage [VDC]
RGC..15	25	RK5	5	Max. 600
RGS..15	25	RK5	5	Max. 600
RGS..25	25	RK5	5	Max. 600

### Co-ordination type 1 (IEC/EN 60947-4-1)

Part no.	Max. fuse size [A]	SIBA part no.	Current [kA]	Voltage [VDC]
RGC..15	16	9008010.16	5	Max. 600
RGS..15	16	9008010.16	5	Max. 600
RGS..25	25	9008010.25	5	Max. 600



## Environmental Information

The declaration in this section is prepared in compliance with People's Republic of China Electronic Industry Standard SJ/T11364-2014: Marking for the Restricted Use of Hazardous Substances in Electronic and Electrical Products.

Part Name	Toxic or Harardous Substances and Elements					
	Lead (Pb)	Mercury (Hg)	Cadmium (Cd)	Hexavalent Chromium (Cr(VI))	Polybrominated biphenyls (PBB)	Polybrominated diphenyl ethers (PBDE)
Power Unit Assembly	x	○	○	○	○	○

O: Indicates that said hazardous substance contained in homogeneous materials fot this part are below the limit requirement of GB/T 26572.

X: Indicates that said hazardous substance contained in one of the homogeneous materials used for this part is above the limit requirement of GB/T 26572.

## 环境特性

这份申明根据中华人民共和国电子工业标准 SJ/T11364-2014：标注在电子电气产品中限定使用的有害物质

零件名称	有毒或有害物质与元素					
	铅 (Pb)	汞 (Hg)	镉 (Cd)	六价铬 (Cr(VI))	多溴化联苯 (PBB)	多溴联苯醚 (PBDE)
功率单元	x	○	○	○	○	○

O:此零件所有材料中含有的该有害物低于GB/T 26572的限定。

X: 此零件某种材料中含有的该有害物高于GB/T 26572的限定。

