

SPECIFICATION **CSM28B2CG**
PACKAGE OUTLINES

RECOMMEND PAD LAYOUT

- Notes:
1. All dimensions are in millimeters (inches).
 2. Tolerance is $\pm 0.25\text{mm}$ ($0.01''$) unless otherwise noted.
 3. Specifications are subject to change without notice.

Part Number	Chip Material	Color of Emission	Lens Type	Viewing Angle
CSM28B2CG	InGaN	Blue	Water Clear	20°

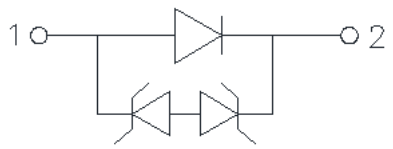
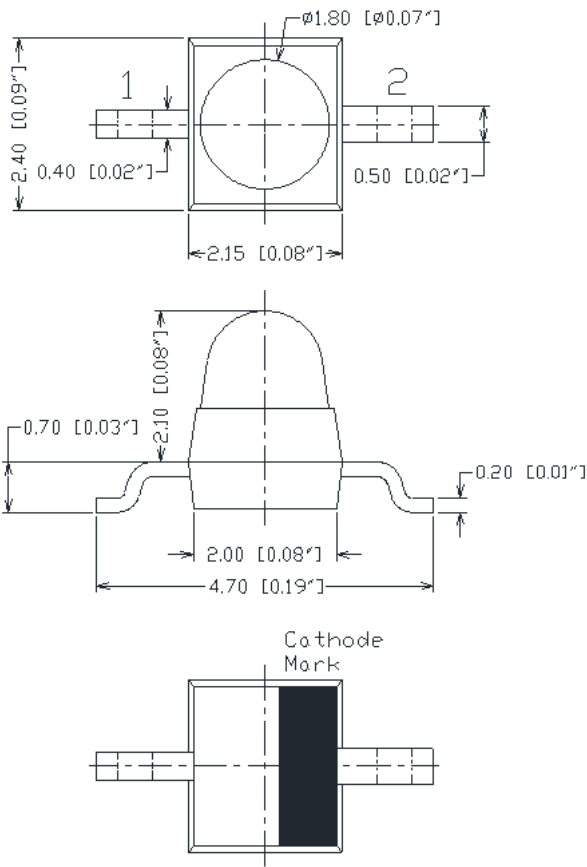
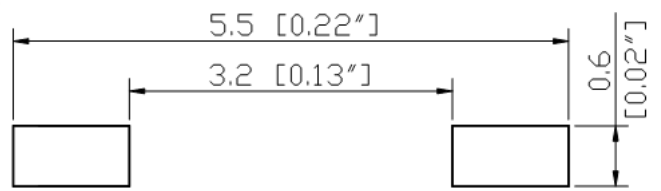

ChromeLED Corp. reserves the right to make changes at any time in order to supply the best product possible. The most current version of this document will always be available at: www.chromeled.com

ABSOLUTE MAXIMUM RATINGS
(TA=25°C)

Parameter	Symbol	Max Rating	Unit
Forward Current	IF	30	mA
Reverse Current @ 5V	VR	10	μA
Power Dissipation	Pd	111	mW
Operating Temperature Range	TOP	-40~+80	°C
Storage Temperature Range	TSTG	-40~+85	°C
Peak Pulsing Current (1/10 duty f = 10KHz)	IFP	125	mA
Soldering Temperature	TSOL	Max 260°C for 10 sec Max	

OPTICAL-ELECTRICAL CHARACTERISTICS
(TA=25°C)

Parameter	Symbol	Test Condition	Value			Unit
			Min	Typ	Max	
Luminous Intensity	Iv	IF = 20mA	800	1300	-	mcd
Forward Voltage	VF	IF = 20mA	-	3.1	3.7	V
Reverse Leakage Current	IR	VR = 5V	-	-	10	μA
Viewing Angle at 50% Iv	2θ1/2	IF = 20mA	-	20	-	Deg
Peak Wavelength	λP	IF = 20mA	-	460	-	nm
Dominant Wavelength	λD	IF = 20mA	460	465	470	nm

*Tolerance of viewing angle: -10 / +5 deg.



ChromeLED Corp. reserves the right to make changes at any time in order to supply the best product possible. The most current version of this document will always be available at: www.chromeled.com

OPTICAL CHARACTERISTIC CURVES

Relative Intensity vs. Wavelength

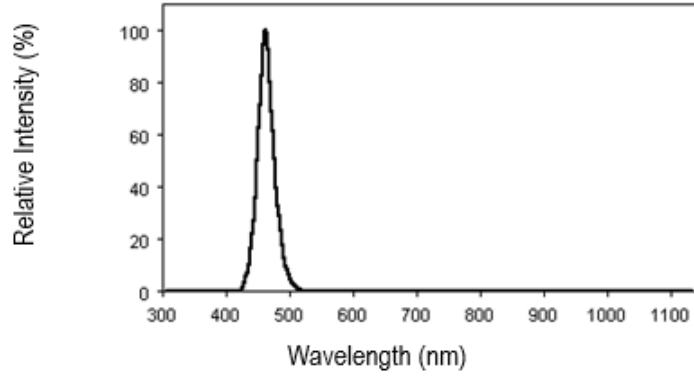

Forward Current vs. Forward Voltage

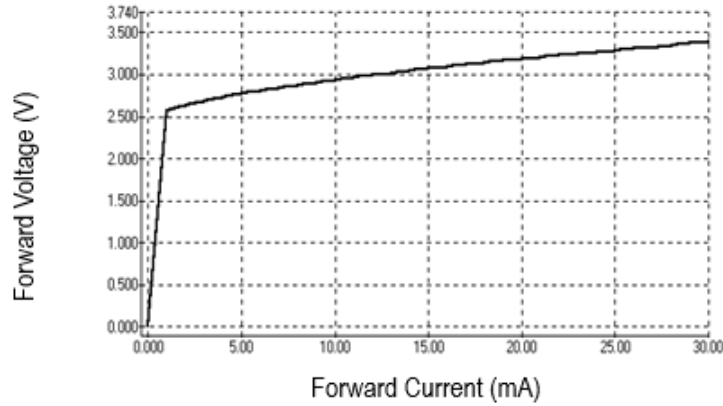

Directive Characteristics

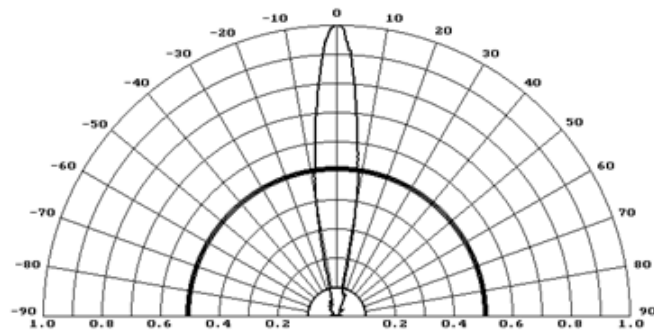

ChromeLED Corp. reserves the right to make changes at any time in order to supply the best product possible. The most current version of this document will always be available at: www.chromeled.com

PACKAGING SPECIFICATION

- Feeding Direction



- Dimensions of Reel (Unit: mm)

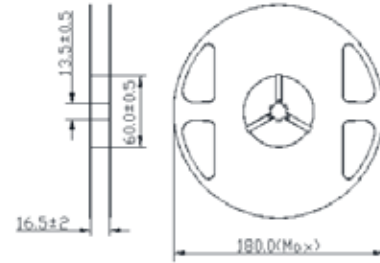

- Dimensions of Tape (Unit: mm)

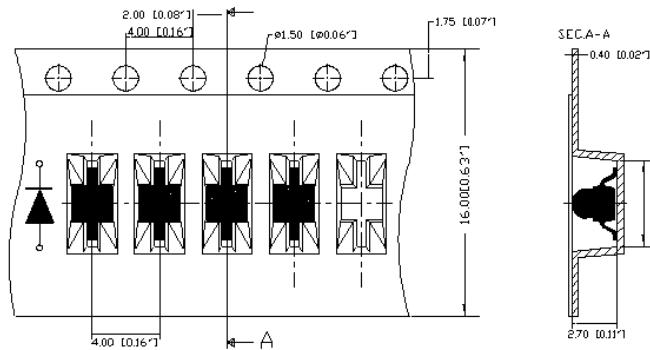

- Arrangement of Tape

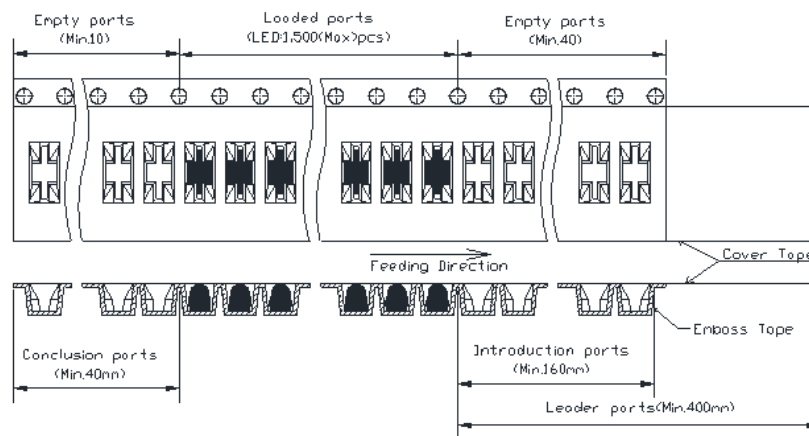

Notes:

1. Empty component pockets are sealed with top cover tape;
2. The maximum number of missing lamps is two;
3. The cathode is oriented towards the tape sprocket hole;
4. 1,500(Max)pcs/Reel



ChromeLED Corp. reserves the right to make changes at any time in order to supply the best product possible. The most current version of this document will always be available at: www.chromeled.com

SOLDERING CONDITIONS

- **Reflow Temp/time**

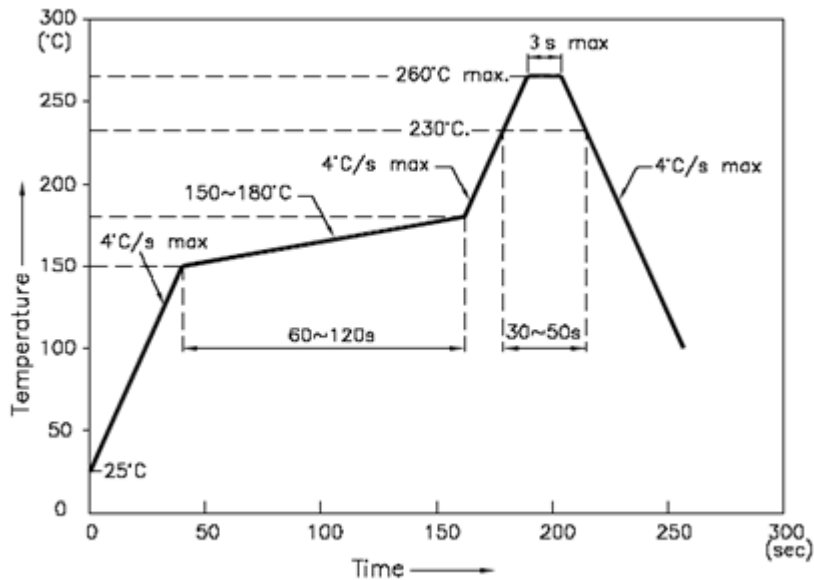

Notes:

1. We recommend the reflow temperature 245°C (±5°C).the maximum soldering temperature should be limited to 260°C.
2. Don't cause stress to the epoxy resin while it is exposed to high temperature.
3. Number of reflow process shall be 2 times or less.

- **Soldering Iron**

Basic spec is ≤ 5 sec when 260°C. If temperature is higher, time should be shorter (+10°C→1sec).Power dissipation of iron should be smaller than 20W, and temperatures should be controllable .Surface temperature of the device should be under 230°C.



ChromeLED Corp. reserves the right to make changes at any time in order to supply the best product possible. The most current version of this document will always be available at: www.chromeled.com