

MCX 50 Ohm Right Angle Crimp Type Plug - Captivated Contact

 INCHES (MILLIMETERS)
 CUSTOMER DRAWINGS AVAILABLE UPON REQUEST

CABLE TYPE	GOLD PLATED	NICKEL PLATED
RG-58/U, 303, 141	133-3407-101	133-3407-106

CABLE GROUP	PART NUMBER	"A"	"B"	"C"	CRIMP HEX
RG-58/u, 303, 141	133-3407-101/106	.067(1.70)	.295 (7.49)	.210 (5.33)	.213 (5.41)

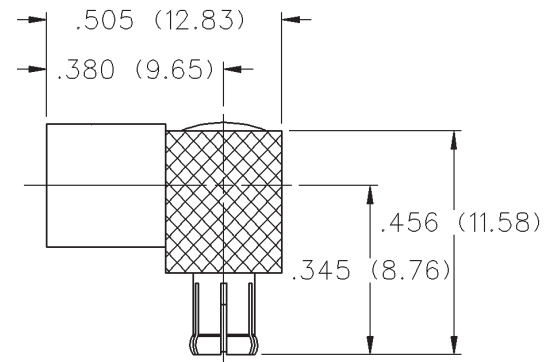
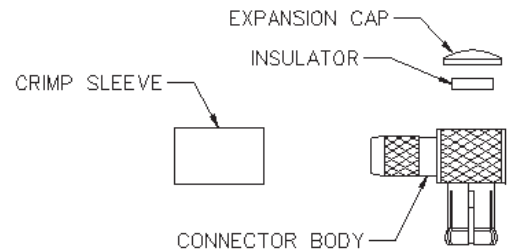
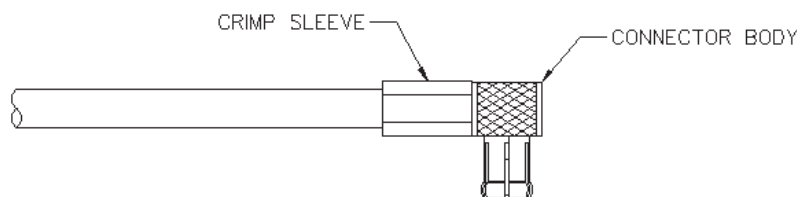
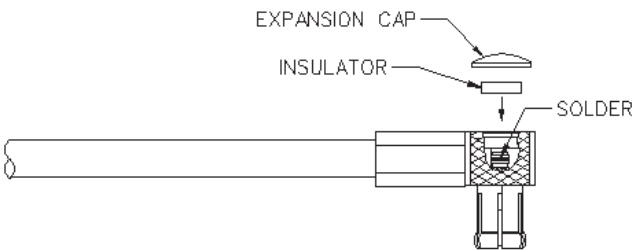
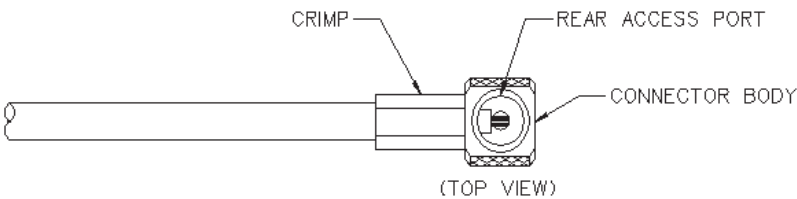
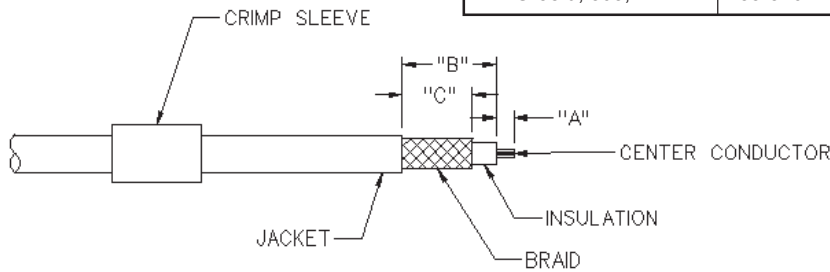

1. Identify connector parts. (4 piece parts except RG-58)
2. Strip cable to dimensions shown. Do not nick braid or center conductor. A wire stripper of correct size is recommended for this step. Twist stranded center conductor into tight bundle and tin (optional). Slide crimp sleeve onto cable shown.
3. Flair braid and slide cable into body making certain that the cable insulation bottoms on center contact. Arrange braid uniformly around crimp stem. Slide crimp sleeve over braid and crimp securely using recommended crimp tool.
4. Solder center conductor to contact through rear access port. Use a minimum amount of solder for a full fillet joint. **.020 (0.51) diameter solder is recommended.**
5. Assemble insulator if applicable then place expansion cap in access port and seat with .156 (3.96) diameter flat punch or MCX hand assembly tool 141-0000-908. Shrink heat shrink tubing over crimp sleeve if applicable.

MCX - 50 Ohm Connectors

Specifications



INCHES (MILLIMETERS)
CUSTOMER DRAWINGS AVAILABLE UPON REQUEST

ELECTRICAL RATINGS

Impedance: 50 Ohms

Frequency Range: Connectors 0-6 GHz
Dummy loads 0-1 GHz

VSWR: (f = GHz)

	Straight Cabled Connectors	Right Angle Cabled Connectors
RG-178 cable	1.17 + .04f	1.07 + .06f
RG-316 and .086 semi-rigid cable	1.13 + .04f	1.07 + .04f
Adapters		1.13 + .04f
Uncabled receptacles, Dummy loads		N/A

Working Voltage: (Vrms maximum)†

Connector for Cable Type	Sea Level	70K Feet
RG-178	250	65
RG-316, .086 semi-rigid uncabled uncabled receptacles, adapters	335	85
Dummy loads		N/A

Dielectric Withstanding Voltage: (VRMS minimum at sea level)

Connectors for RG-178	750
Connectors for RG-316, .086 semi-rigid, uncabled receptacles, adapters	1000
Dummy loads	N/A

Corona Level: (Volts minimum at 70,000 feet)

Connectors for RG-178	190
Connectors for RG-316, .086 semi-rigid uncabled receptacles, adapters	250
Dummy loads	N/A

Insertion Loss: (dB maximum, tested at 1 GHz)

Straight cable connectors and adapters	0.1 dB
Right angle cable connectors	0.2 dB
Uncabled receptacles, dummy loads	N/A

Insulation Resistance: 10,000 megohms minimum

Contact Resistance: (milliohms maximum)

	Initial	After Environmental
Center contact (straight cabled connectors, uncabled receptacles and adapters)	5.0	8.0
Center contact (right angle cabled connectors)	5.0	15.0
Outer contact	1.0	1.5
Braid to body (gold plated connectors)	1.0	N/A
Braid to body (nickel plated connectors)	2.5	N/A

RF Leakage: (dB typical tested at 2.5 GHz)

Cable connectors	-55 dB
Uncabled receptacles and adapters, dummy loads	N/A

RF High Potential Withstanding Voltage: (Vrms minimum, tested at 4 and 7 MHz)

Connectors for RG178	500
Connectors for RG316 and adapters	700
.086 semi-rigid	670
Uncabled receptacles	600
Dummy loads	N/A

Power Rating (Dummy Load): 0.5 watt @ +25°C, derated to 0.25 watt @ +125°C

MECHANICAL RATINGS

Engagement Design: Compatible with CECC 22220, Series MCX

Engagement Force: 5.6 pounds maximum axial force

Disengagement Force: 8 pounds maximum axial force, 1 pound min.

Contact Retention: 2.3 pounds min. axial force (captivated contacts)
1 inch-ounce min. torque (uncabled receptacles)

Cable Retention:	Axial Force* (pounds)	Torque (in-oz)
Connectors for RG178	10	N/A
Connectors for RG316	20	N/A
Connectors for RG316DS	25	N/A
Connectors for .086 semi-rigid	30	16

* or cable breaking strength whichever is less.

ENVIRONMENTAL RATINGS (Meets or exceed the applicable paragraph of MIL-C-39012)

Durability: 500 cycles minimum

Temperature Range: Connectors - 65°C to + 165°C

Dummy loads - 65°C to + 125°C

Thermal Shock: MIL-STD-202, Method 107, Condition F (N/A dummy loads)

Corrosion: MIL-STD-202, Method 101, Condition B (N/A dummy loads)

Shock: MIL-STD-202, Method 213, Condition B (N/A dummy loads)

Vibration: MIL-STD-202, Method 204, Condition B (N/A dummy loads)

Moisture Resistance: MIL-STD-202, Method 106 (N/A dummy loads)

MATERIAL SPECIFICATIONS

Bodies: Brass per QQ-B-626 or zinc per ASTM B86-71, gold plated** per MIL-G-45204 .00001" min or nickel plated per QQ-N-290 or bright tin plated

Contacts: Male - brass per QQ-B-626, gold plated per MIL-G-45204 .00003" min.

Female - beryllium copper per QQ-C-530, gold plated per MIL-G-45204 .00003" min.

Insulators: PTFE fluorocarbon per ASTM D 1710 and ASTM D 1457

Expansion Caps: Brass per QQ-B-613, gold plated per MIL-G-45204 .00001" min. or nickel plated per QQ-N-290

Crimp Sleeves: Copper per WW-T-799, gold plated per MIL-G-45204 .00001" min. or nickel plated per QQ-N-290

Mounting Hardware: Brass (nuts) per QQ-B-626 or phosphor bronze (lockwashers) QQ-B-750, gold plated per MIL-G-45204 .00001" min. or nickel plated per QQ-N-290

Avoid user injury due to misapplication. See safety advisory definitions on page 2.

** All gold plated parts include a .00005" min. nickel underplate barrier layer.

MATING ENGAGEMENT FOR MCX SERIES COMPATIBLE WITH CECC 22220

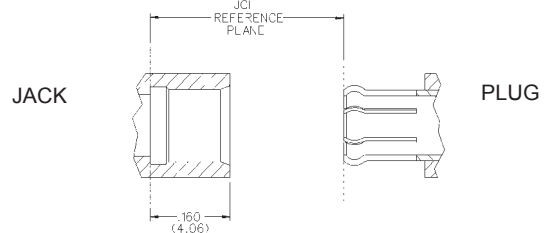
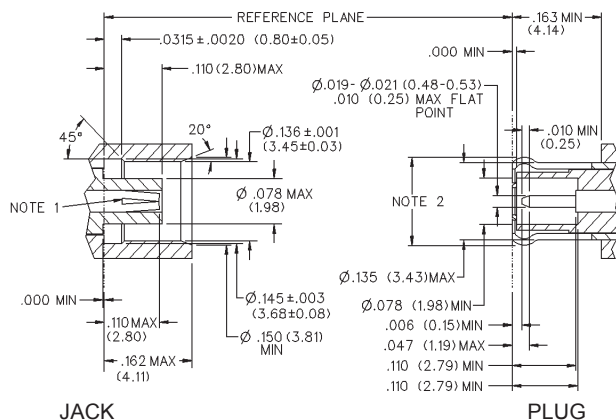

NOTES

1. ID of contact to meet VSWR mating characteristics and connector durability when mated with a dia. .019-.021 (0.48-0.53) male contact.
2. Must meet the force to engage and disengage when mated with mating part.