

# TPS7A26 500-mA, 18-V, Ultra-Low $I_Q$ , Low-Dropout Linear Voltage Regulator With Power-Good

## 1 Features

- Ultra-low  $I_Q$ : 2.0  $\mu$ A
- Input voltage: 2.4 V to 18 V
- Output voltage options available:
  - Fixed: 1.25 V to 5.5 V
  - Adjustable: 1.24 V to 17.4 V
- 1% accuracy over temperature
- Low dropout: 590 mV (max) at 500 mA
- Open-drain, power-good output
- Active overshoot pulldown protection
- Thermal shutdown and overcurrent protection
- Operating junction temperature:  $-40^{\circ}\text{C}$  to  $+125^{\circ}\text{C}$
- Stable with 1- $\mu$ F output capacitors
- Package: 6-pin WSON

## 2 Applications

- Home and building automation
- Multicell power banks
- Smart grid and metering
- Portable power tools
- Motor drives
- White goods
- Portable appliances

## 3 Description

The TPS7A26 low-dropout (LDO) linear voltage regulator supports a 2.4-V to 18-V input voltage range with very-low quiescent current ( $I_Q$ ). These features help modern appliances meet increasingly stringent energy requirements and help extend battery life in portable-power solutions.

The TPS7A26 is available in both fixed and adjustable versions. For more flexibility or higher output voltages, the adjustable version uses feedback resistors to set the output voltage from 1.24 V to 17.4 V. Both versions have 1% output regulation accuracy that provides precision regulation for microcontroller (MCU) references.

With the open-drain, power-good (PG) output the device can provide a reset to an MCU or be wire-ORed and level-shifted with other open-drain PGs to provide a system-wide PG or reset.

The TPS7A26 LDO operates more efficiently than standard linear regulators because the maximum dropout voltage is less than 590 mV at 500 mA of current. This maximum dropout voltage allows for 87.7% efficiency from a 5.7-V input voltage ( $V_{IN}$ ) to 5.0-V output voltage ( $V_{OUT}$ ).

For lower power applications, consider the [TPS7A25](#).

### Device Information<sup>(1)</sup>

| PART NUMBER | PACKAGE  | BODY SIZE (NOM)   |
|-------------|----------|-------------------|
| TPS7A26     | WSON (6) | 2.00 mm x 2.00 mm |

(1) For all available packages, see the package option addendum at the end of the datasheet.

### Typical Application Circuit

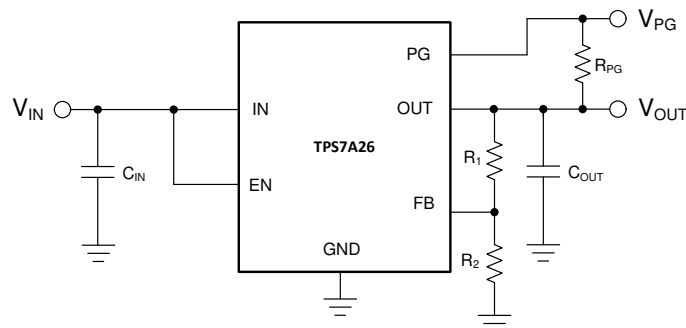

## Table of Contents

|          |  |           |           |   |           |
|----------|--|-----------|-----------|---|-----------|
| <b>1</b> | <b>Features</b> .....                        | <b>1</b>  | <b>8</b>  | <b>Application and Implementation</b> .....                   | <b>17</b> |
| <b>2</b> | <b>Applications</b> .....                    | <b>1</b>  | 8.1       | Application Information.....                                  | 17        |
| <b>3</b> | <b>Description</b> .....                     | <b>1</b>  | 8.2       | Typical Application .....                                     | 20        |
| <b>4</b> | <b>Revision History</b> .....                | <b>2</b>  | <b>9</b>  | <b>Power Supply Recommendations</b> .....                     | <b>23</b> |
| <b>5</b> | <b>Pin Configuration and Functions</b> ..... | <b>3</b>  | <b>10</b> | <b>Layout</b> .....   | <b>23</b> |
| <b>6</b> | <b>Specifications</b> .....                  | <b>4</b>  | 10.1      | Layout Guidelines .....                                       | 23        |
| 6.1      | Absolute Maximum Ratings .....               | 4         | 10.2      | Layout Examples.....  | 23        |
| 6.2      | ESD Ratings.....                             | 4         | <b>11</b> | <b>Device and Documentation Support</b> .....                 | <b>24</b> |
| 6.3      | Recommended Operating Conditions.....        | 4         | 11.1      | Device Support.....   | 24        |
| 6.4      | Thermal Information .....                    | 4         | 11.2      | Documentation Support .....                                   | 24        |
| 6.5      | Electrical Characteristics.....              | 5         | 11.3      | Receiving Notification of Documentation Updates               | 24        |
| 6.6      | Typical Characteristics .....                | 6         | 11.4      | Community Resources.....                                      | 24        |
| <b>7</b> | <b>Detailed Description</b> .....            | <b>12</b> | 11.5      | Trademarks .....  | 24        |
| 7.1      | Overview .....                               | 12        | 11.6      | Electrostatic Discharge Caution.....                          | 24        |
| 7.2      | Functional Block Diagram .....               | 12        | 11.7      | Glossary .....  | 24        |
| 7.3      | Feature Description.....                     | 13        | <b>12</b> | <b>Mechanical, Packaging, and Orderable Information</b> ..... | <b>24</b> |
| 7.4      | Device Functional Modes.....                 | 16        |           |   |           |

## 4 Revision History

| <b>Changes from Revision A (March 2019) to Revision B</b> |   | <b>Page</b> |
|---|---|-------------|
| •   | Added fixed-voltage version to document .....   | 1           |
| •   | Changed adjustable version output voltage from 0.24 V to 17.45 V to 1.24 V to 17.4 V..... | 1           |
| •   | Deleted fixed-voltage version description from <i>Description</i> section .....           | 1           |
| •   | Added reference to TPS7A25 in <i>Description</i> section .....                            | 1           |
| •   | Added <i>Active</i> to <i>Overshoot Pulldown Circuitry</i> title .....                    | 15          |

| <b>Changes from Original (December 2019) to Revision A</b> |  | <b>Page</b> |
|--|--|-------------|
| •  | Changed status from Advance Information to Production Data ..... | 1           |

## 5 Pin Configuration and Functions

**TPS7A26: DRV Package (Adjustable)  
6-Pin WSON  
Top View**

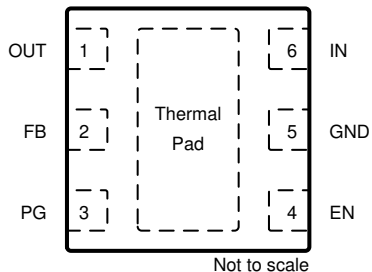

**TPS7A26: DRV Package (Fixed)  
6-Pin WSON  
Top View**

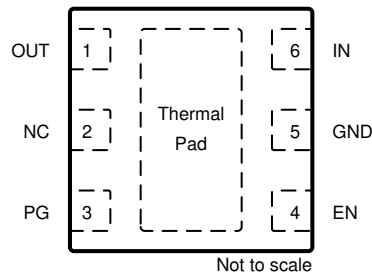

### Pin Functions

| NAME        | PIN              |             | I/O    | DESCRIPTION   |
|-------------|------------------|-------------|--------|---|
|             | DRV (Adjustable) | DRV (Fixed) |        |   |
| EN          | 4                | 4           | Input  | Enable pin. Drive EN greater than $V_{EN(HI)}$ to enable the regulator. Drive EN less than $V_{EN(LOW)}$ to put the regulator into low-current shutdown. Do not float this pin. If not used, connect EN to IN.  |
| FB          | 2                | —           | Input  | Feedback pin. Input to the control-loop error amplifier. This pin is used to set the output voltage of the device with the use of external resistors. For adjustable-voltage version devices only.  |
| GND         | 5                | 5           | —      | Ground pin.   |
| IN          | 6                | 6           | Input  | Input pin. For best transient response and to minimize input impedance, use the recommended value or larger capacitor from IN to ground as listed in the <a href="#">Recommended Operating Conditions</a> table. Place the input capacitor as close to the IN and GND pins of the device as possible.   |
| NC          | —                | 2           | —      | No internal connection. For fixed-voltage version devices only. This pin can be floated but the device has better thermal performance with this pin tied to GND.  |
| OUT         | 1                | 1           | Output | Output pin. A capacitor is required from OUT to ground for stability. For best transient response, use the nominal recommended value or larger capacitor from OUT to ground. Follow the recommended capacitor value as listed in the <a href="#">Recommended Operating Conditions</a> table. Place the output capacitor as close to the OUT and GND pins of the device as possible.   |
| PG          | 3                | 3           | Output | Power-good pin; open-collector output. Pullup this pin externally to the OUT pin or another voltage rail. The PG pin goes high when $V_{OUT} > V_{IT(PG,RISING)}$ , as discussed in the <a href="#">Electrical Characteristics</a> table. The PG pin is driven low when $V_{OUT} < V_{IT(PG,FALLING)}$ , as discussed in the <a href="#">Electrical Characteristics</a> table. This pin can be floated but the device has better thermal performance with this pin tied to GND. |
| Thermal pad | Pad              | Pad         | —      | Exposed pad of the package. Connect this pad to ground or leave floating. Connect the thermal pad to a large-area ground plane for best thermal performance.  |

## 6 Specifications

### 6.1 Absolute Maximum Ratings

 over operating free-air temperature range (unless otherwise noted)<sup>(1)</sup>

|                        |                                    | MIN                | MAX                   | UNIT |
|------------------------|------------------------------------|--------------------|-----------------------|------|
| Voltage <sup>(2)</sup> | V <sub>IN</sub>                    | -0.3               | 20                    | V    |
|                        | V <sub>OUT</sub> <sup>(3)</sup>    | -0.3               | V <sub>IN</sub> + 0.3 |      |
|                        | V <sub>FB</sub>                    | -0.3               | 5.5                   |      |
|                        | V <sub>EN</sub>                    | -0.3               | 20                    |      |
|                        | V <sub>PG</sub>                    | -0.3               | 20                    |      |
| Current                | Maximum output                     | Internally limited |                       | A    |
| Temperature            | Operating junction, T <sub>J</sub> | -50                | 150                   | °C   |
|                        | Storage, T <sub>stg</sub>          | -65                | 150                   |      |

- (1) Stresses beyond those listed under *Absolute Maximum Ratings* may cause permanent damage to the device. These are stress ratings only, which do not imply functional operation of the device at these or any other conditions beyond those indicated under *Recommended Operating Conditions*. Exposure to absolute-maximum-rated conditions for extended periods may affect device reliability.
- (2) All voltages with respect to GND.
- (3) V<sub>IN</sub> + 0.3 V or 20 V (whichever is smaller).

### 6.2 ESD Ratings

|                    |                         |  | VALUE | UNIT |
|--------------------|-------------------------|--|-------|------|
| V <sub>(ESD)</sub> | Electrostatic discharge | Human body model (HBM), per ANSI/ESDA/JEDEC JS-001 <sup>(1)</sup>              | ±1500 | V    |
|                    |                         | Charged device model (CDM), per JEDEC specification JESD22-C101 <sup>(2)</sup> | ±1000 |      |

- (1) JEDEC document JEP155 states that 2-kV HBM allows safe manufacturing with a standard ESD control process.
- (2) JEDEC document JEP157 states that 500-V CDM allows safe manufacturing with a standard ESD control process.

### 6.3 Recommended Operating Conditions

|                                 |                                     | MIN  | NOM | MAX                | UNIT |
|---------------------------------|-------------------------------------|------|-----|--------------------|------|
| V <sub>IN</sub>                 | Input voltage                       | 2.4  |     | 18                 | V    |
| V <sub>OUT</sub>                | Output voltage (adjustable version) | 1.24 |     | 18-V <sub>DO</sub> | V    |
| V <sub>OUT</sub>                | Output voltage (fixed version)      | 1.25 |     | 5.5                | V    |
| I <sub>OUT</sub>                | Output current                      | 0    |     | 500                | mA   |
| V <sub>EN</sub>                 | Enable voltage                      | 0    |     | 18                 | V    |
| V <sub>PG</sub> <sup>(1)</sup>  | Power-good voltage                  | 0    |     | 18                 | V    |
| C <sub>IN</sub> <sup>(2)</sup>  | Input capacitor                     |      | 1   |                    | μF   |
| C <sub>OUT</sub> <sup>(2)</sup> | Output capacitor                    | 1    | 2.2 | 100                | μF   |
| T <sub>J</sub>                  | Operating junction temperature      | -40  |     | 125                | °C   |

- (1) Select pullup resistor to limit PG pin sink current when PG output is driven low. See *Power Good* section for details.
- (2) All capacitor values are assumed to derate to 50% of the nominal capacitor value.

### 6.4 Thermal Information

| THERMAL METRIC <sup>(1)</sup> |  | TPS7A26    | UNIT |
|-------------------------------|--|------------|------|
|                               |  | DRV (WSON) |      |
|                               |  | 6 PINS     |      |
| R <sub>θJA</sub>              | Junction-to-ambient thermal resistance       | 73.3       | °C/W |
| R <sub>θJC(top)</sub>         | Junction-to-case (top) thermal resistance    | 90.6       | °C/W |
| R <sub>θJB</sub>              | Junction-to-board thermal resistance         | 38.3       | °C/W |
| Ψ <sub>JT</sub>               | Junction-to-top characterization parameter   | 3.7        | °C/W |
| Ψ <sub>JB</sub>               | Junction-to-board characterization parameter | 38.4       | °C/W |
| R <sub>θJC(bot)</sub>         | Junction-to-case (bottom) thermal resistance | 14.3       | °C/W |

- (1) For more information about traditional and new thermal metrics, see the [Semiconductor and IC Package Thermal Metrics](#) application report.

## 6.5 Electrical Characteristics

specified at  $T_J = -40^\circ\text{C}$  to  $+125^\circ\text{C}$ ,  $V_{IN} = V_{OUT(nom)} + 0.8\text{ V}$  or  $V_{IN} = 2.4\text{ V}$  (whichever is greater), FB tied to OUT,  $I_{OUT} = 1\text{ mA}$ ,  $V_{EN} = 2\text{ V}$ , and  $C_{IN} = 1\text{ }\mu\text{F}$ ,  $C_{OUT} = 2.2\text{ }\mu\text{F}$  (unless otherwise noted); typical values are at  $T_J = 25^\circ\text{C}$

| PARAMETER                        |  | TEST CONDITIONS  | MIN   | TYP  | MAX   | UNIT                |
|----------------------------------|--|--|-------|------|-------|---------------------|
| $V_{UVLO(RISING)}$               | UVLO threshold rising                            | $V_{IN}$ rising  | 1.95  | 2.15 | 2.35  | V                   |
| $V_{UVLO(HYS)}$                  | UVLO hysteresis                                  |  |       | 70   |       | mV                  |
| $V_{UVLO(FALLING)}$              | UVLO threshold falling                           | $V_{IN}$ falling   | 1.85  | 2.09 | 2.25  | V                   |
| $V_{FB}$                         | Feedback voltage                                 | Adjustable version only  |       | 1.24 |       | V                   |
| $V_{OUT}$                        | Output voltage accuracy                          | Adjustable version, $V_{OUT} = V_{FB}$   | 1.228 | 1.24 | 1.252 | V                   |
| $V_{OUT}$                        | Output voltage accuracy for fixed output options | Fixed output versions  | -1    |      | 1     | %                   |
| $\Delta V_{OUT(\Delta V_{IN})}$  | Line regulation <sup>(1)</sup>                   | $(V_{OUT(nom)} + 0.8\text{ V or } 2.4\text{ V}) \leq V_{IN} \leq 18\text{ V}$        | -0.1  |      | 0.1   | %                   |
| $\Delta V_{OUT(\Delta I_{OUT})}$ | Load regulation                                  | $1\text{ mA} \leq I_{OUT} \leq 500\text{ mA}$  | -0.5  |      | 0.5   | %                   |
| $V_{DO}$                         | Dropout voltage <sup>(2)</sup>                   | $I_{OUT} = 100\text{ mA}$  |       | 92   | 145   | mV                  |
|                                  |  | $I_{OUT} = 250\text{ mA}$  |       | 173  | 280   |                     |
|                                  |  | $I_{OUT} = 500\text{ mA}$  |       | 355  | 590   |                     |
| $I_{CL}$                         | Output current limit                             | $V_{OUT} = 0.9 \times V_{OUT(nom)}$  | 525   | 717  | 970   | mA                  |
| $I_{GND}$                        | Ground pin current                               | $I_{OUT} = 0\text{ mA}$  |       | 2    | 4.5   | $\mu\text{A}$       |
|                                  |  | $I_{OUT} = 1\text{ mA}$  |       | 15   |       |                     |
| $I_{SHUTDOWN}$                   | Shutdown current                                 | $V_{EN} \leq 0.4\text{ V}$ , $V_{IN} = 2.4\text{ V}$ , $I_{out} = 0\text{ mA}$       |       | 325  | 600   | nA                  |
| $I_{FB}$                         | FB pin current                                   |  |       | 10   |       | nA                  |
| $I_{EN}$                         | EN pin current                                   | $V_{EN} = 18\text{ V}$   |       | 10   |       | nA                  |
| $V_{EN(HI)}$                     | Enable pin high-level input voltage              | Device enabled   | 0.9   |      |       | V                   |
| $V_{EN(LOW)}$                    | Enable pin low-level input voltage               | Device disabled  |       |      | 0.4   | V                   |
| $V_{IT(PG,RISING)}$              | PG pin threshold rising                          | $R_{PULLUP} = 10\text{ k}\Omega$ , $V_{OUT}$ rising, $V_{IN} \geq V_{UVLO(RISING)}$  |       | 93   | 96.5  | % $V_{OUT}$         |
| $V_{HYS(PG)}$                    | PG pin hysteresis                                | $R_{PULLUP} = 10\text{ k}\Omega$ , $V_{OUT}$ falling, $V_{IN} \geq V_{UVLO(RISING)}$ |       | 3    |       | % $V_{OUT}$         |
| $V_{IT(PG,FALLING)}$             | PG pin threshold falling                         | $R_{PULLUP} = 10\text{ k}\Omega$ , $V_{OUT}$ falling, $V_{IN} \geq V_{UVLO(RISING)}$ | 84    | 90   |       | % $V_{OUT}$         |
| $V_{OL(PG)}$                     | PG pin low level output voltage                  | $V_{OUT} < V_{IT(PG,FALLING)}$ , $I_{PG-SINK} = 500\text{ }\mu\text{A}$              |       |      | 0.4   | V                   |
| $I_{LKG(PG)}$                    | PG pin leakage current                           | $V_{OUT} > V_{IT(PG,RISING)}$ , $V_{PG} = 18\text{ V}$                               |       | 5    | 300   | nA                  |
| PSRR                             | Power-supply rejection ratio                     | $f = 10\text{ Hz}$   |       | 75   |       | dB                  |
|                                  |  | $f = 100\text{ Hz}$  |       | 62   |       |                     |
|                                  |  | $f = 1\text{ kHz}$   |       | 52   |       |                     |
| $V_n$                            | Output noise voltage                             | $BW = 10\text{ Hz to } 100\text{ kHz}$ , $V_{OUT} = 1.2\text{ V}$                    |       | 300  |       | $\mu\text{V}_{RMS}$ |
| $T_{SD(shutdown)}$               | Thermal shutdown temperature                     | Shutdown, temperature increasing   |       | 165  |       | $^\circ\text{C}$    |
| $T_{SD(reset)}$                  | Thermal shutdown reset temperature               | Reset, temperature decreasing  |       | 145  |       | $^\circ\text{C}$    |

(1)  $V_{out(nom)} + 0.8\text{ V}$  or  $2.4\text{ V}$  (whichever is greater).

(2)  $V_{DO}$  is measured with  $V_{IN} = 0.97 \times V_{OUT(nom)}$  for fixed output voltage versions.  $V_{DO}$  is not measured for fixed output voltage versions when  $V_{OUT} \leq 2.5\text{ V}$ . For the adjustable output device,  $V_{DO}$  is measured with  $V_{FB} = 0.97 \times V_{FB(nom)}$ .

### 6.6 Typical Characteristics

at operating temperature  $T_J = 25^\circ\text{C}$ ,  $I_{OUT} = 1\text{ mA}$ ,  $V_{EN} = 0.9\text{ V}$ ,  $C_{IN} = 2.2\text{ }\mu\text{F}$ ,  $C_{OUT} = 2.2\text{ }\mu\text{F}$ , and  $V_{IN} = V_{OUT(\text{typ})} + 0.8\text{ V}$  or  $2.4\text{ V}$  (whichever is greater), unless otherwise noted; typical values are at  $T_J = 25^\circ\text{C}$

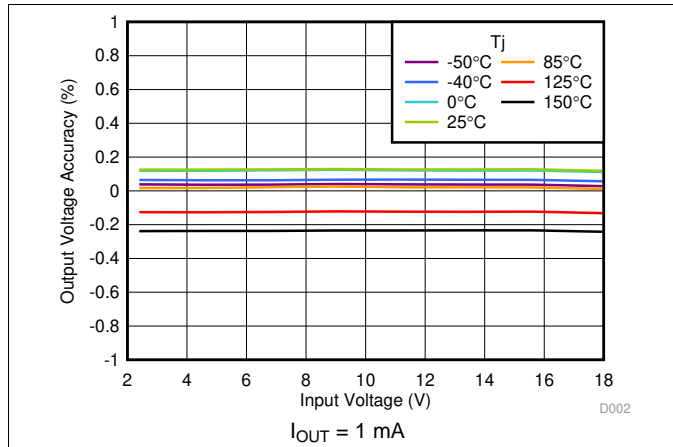

Figure 1. Line Regulation vs  $V_{IN}$

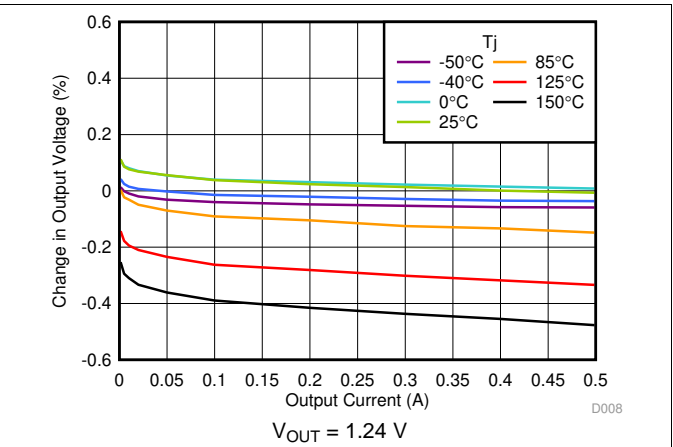

Figure 2. Load Regulation vs  $I_{OUT}$

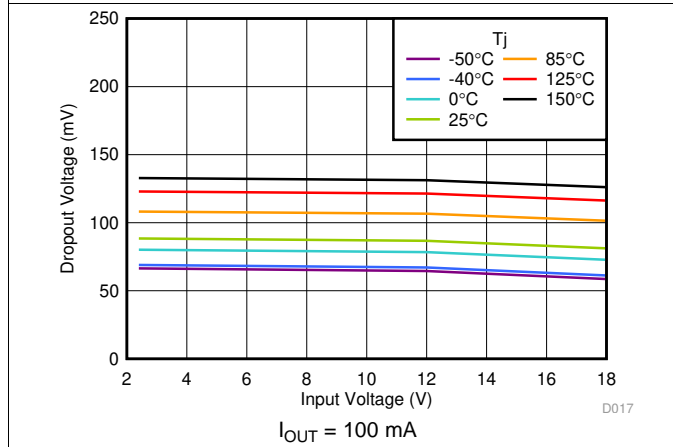

Figure 3. Dropout Voltage vs  $V_{IN}$

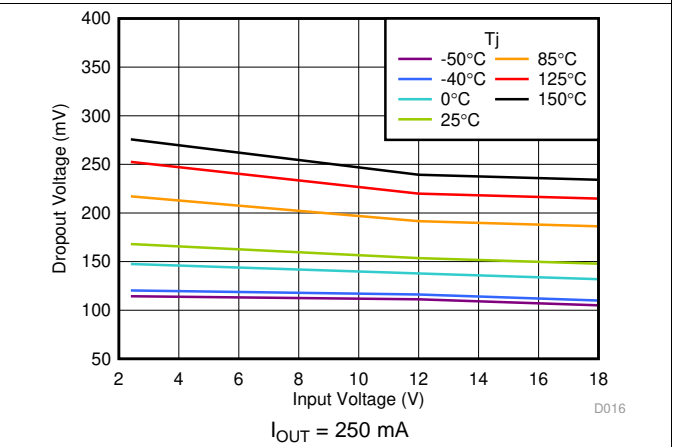

Figure 4. Dropout Voltage vs  $V_{IN}$

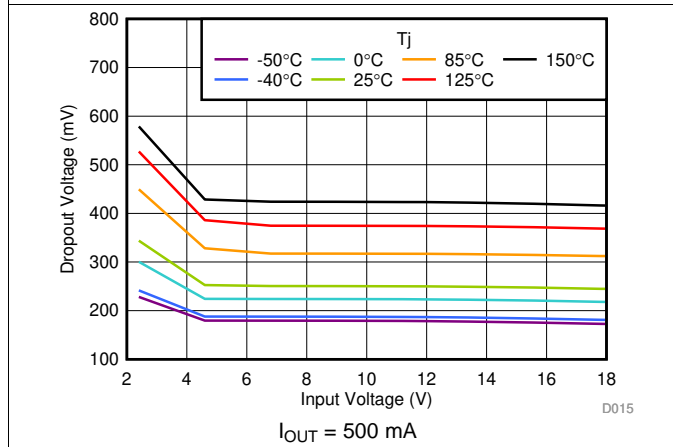

Figure 5. Dropout Voltage vs  $V_{IN}$

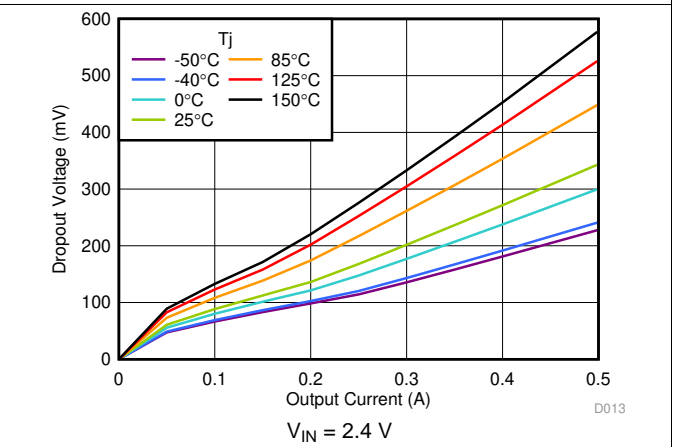

Figure 6. Dropout Voltage vs  $I_{OUT}$

Typical Characteristics (continued)

at operating temperature  $T_J = 25^\circ\text{C}$ ,  $I_{OUT} = 1\text{ mA}$ ,  $V_{EN} = 0.9\text{ V}$ ,  $C_{IN} = 2.2\ \mu\text{F}$ ,  $C_{OUT} = 2.2\ \mu\text{F}$ , and  $V_{IN} = V_{OUT(\text{typ})} + 0.8\text{ V}$  or  $2.4\text{ V}$  (whichever is greater), unless otherwise noted; typical values are at  $T_J = 25^\circ\text{C}$

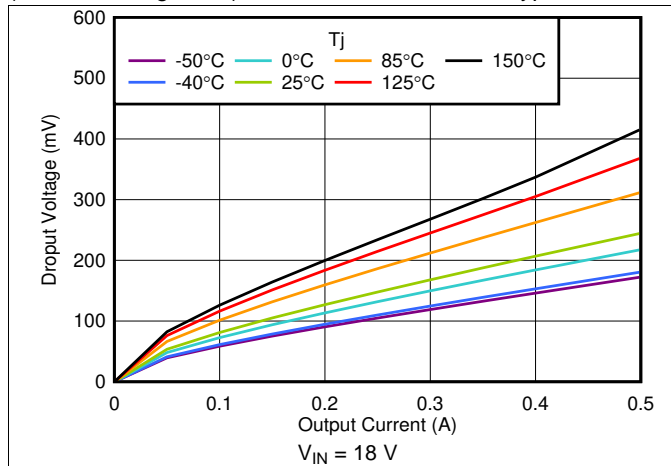

Figure 7. Dropout Voltage vs  $I_{OUT}$

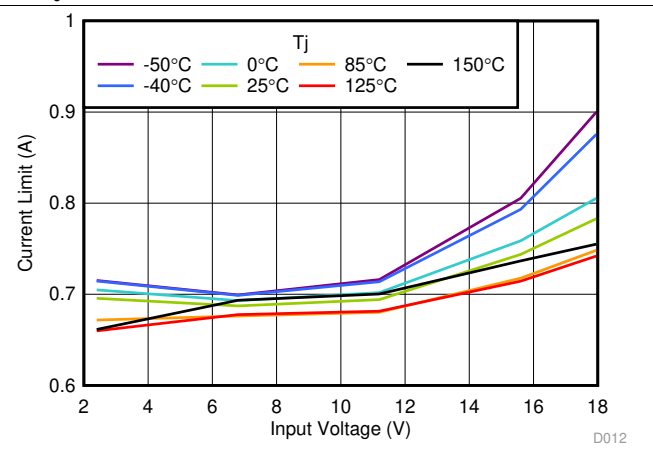

Figure 8. Current Limit vs  $V_{IN}$

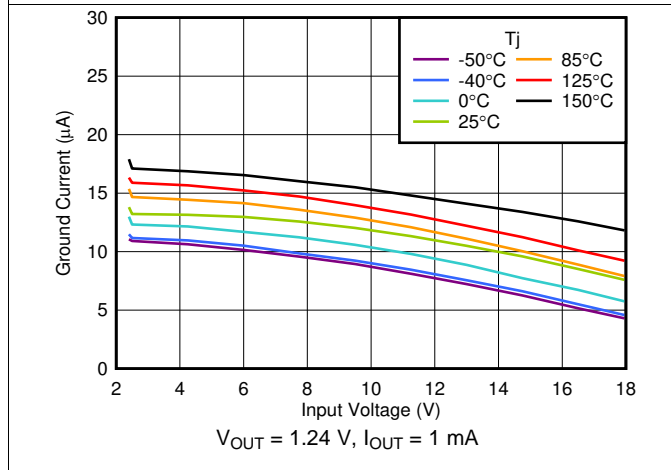

Figure 9.  $I_{GND}$  vs  $V_{IN}$

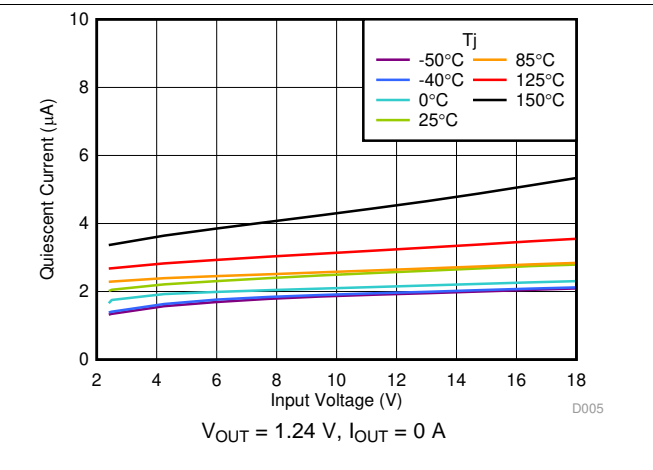

Figure 10.  $I_Q$  vs  $V_{IN}$

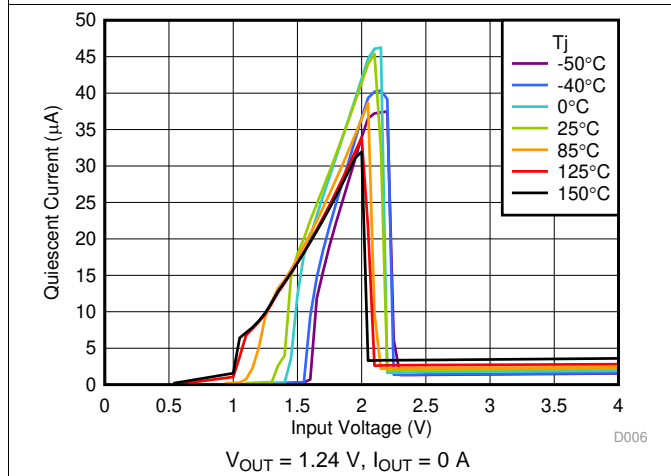

Figure 11.  $I_Q$  vs  $V_{IN}$

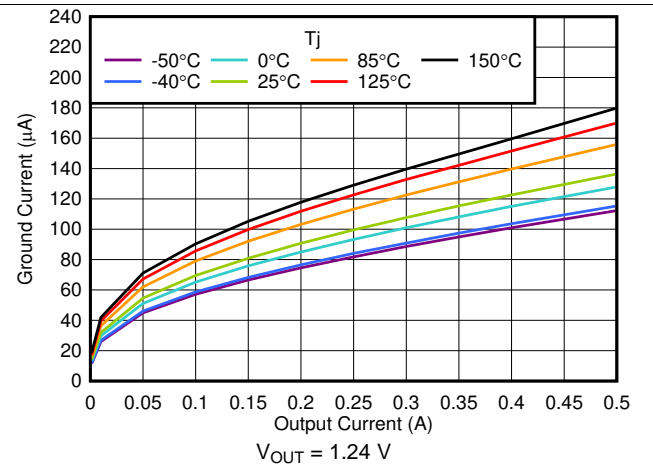

Figure 12.  $I_{GND}$  vs  $I_{OUT}$

### Typical Characteristics (continued)

at operating temperature  $T_J = 25^\circ\text{C}$ ,  $I_{OUT} = 1\text{ mA}$ ,  $V_{EN} = 0.9\text{ V}$ ,  $C_{IN} = 2.2\ \mu\text{F}$ ,  $C_{OUT} = 2.2\ \mu\text{F}$ , and  $V_{IN} = V_{OUT(\text{typ})} + 0.8\text{ V}$  or  $2.4\text{ V}$  (whichever is greater), unless otherwise noted; typical values are at  $T_J = 25^\circ\text{C}$

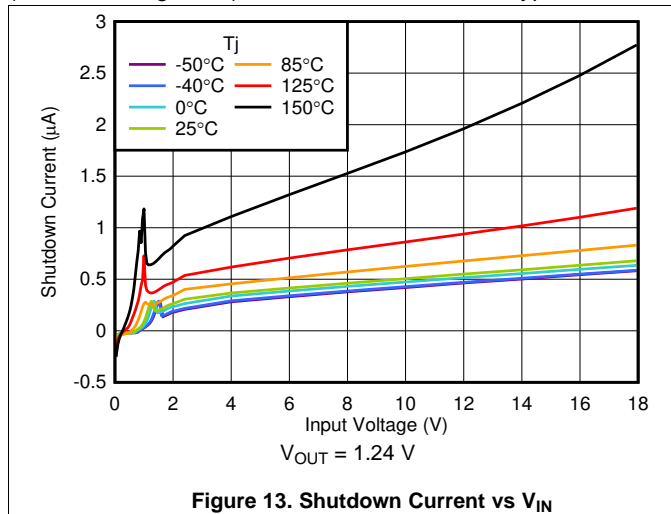

Figure 13. Shutdown Current vs  $V_{IN}$

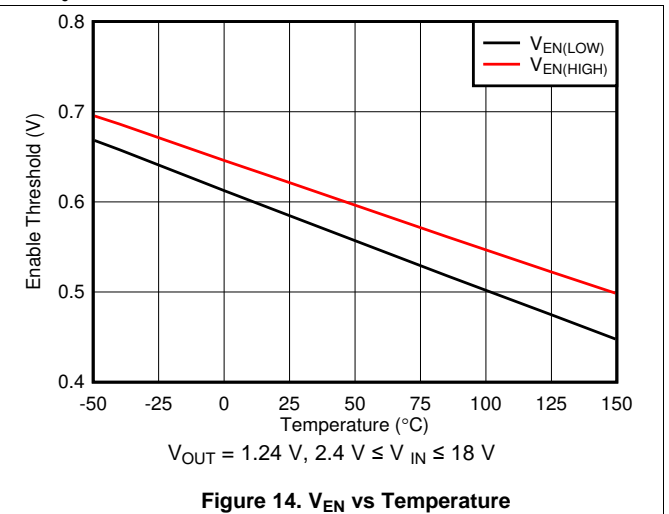

Figure 14.  $V_{EN}$  vs Temperature

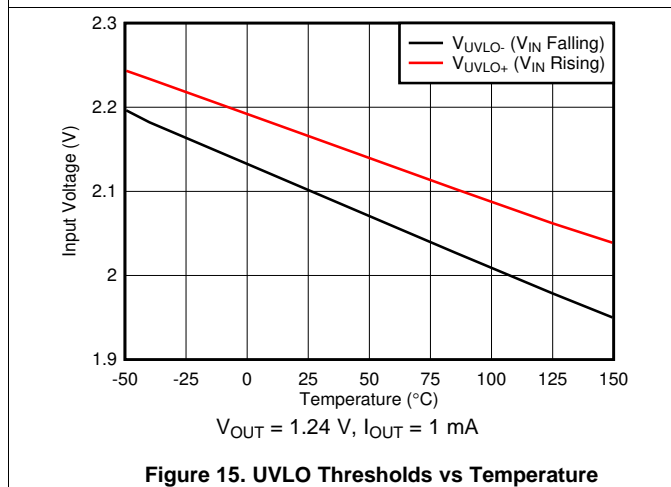

Figure 15. UVLO Thresholds vs Temperature

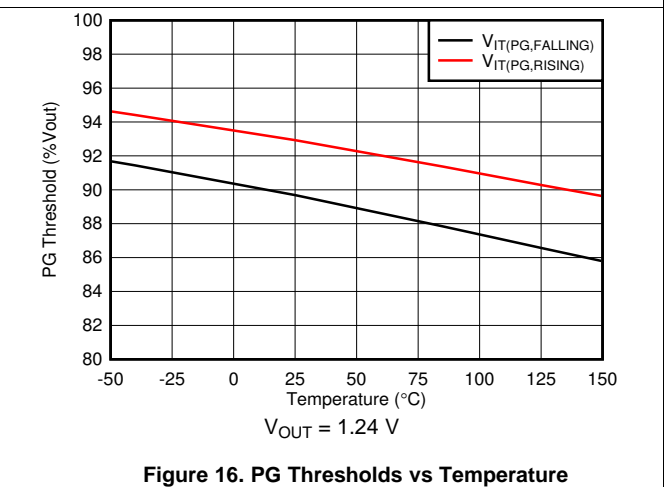

Figure 16. PG Thresholds vs Temperature

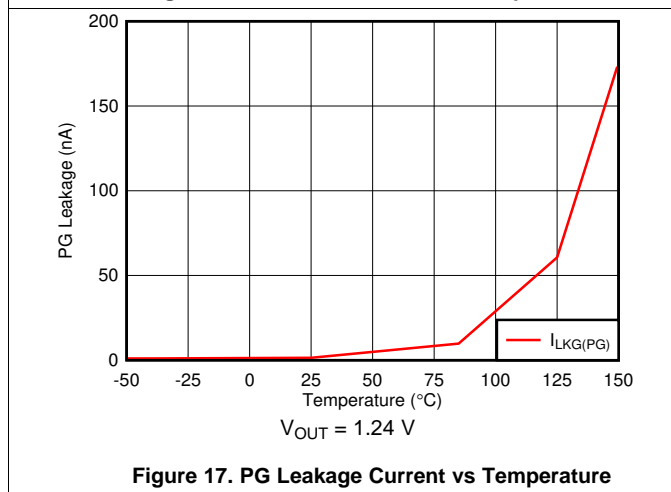

Figure 17. PG Leakage Current vs Temperature

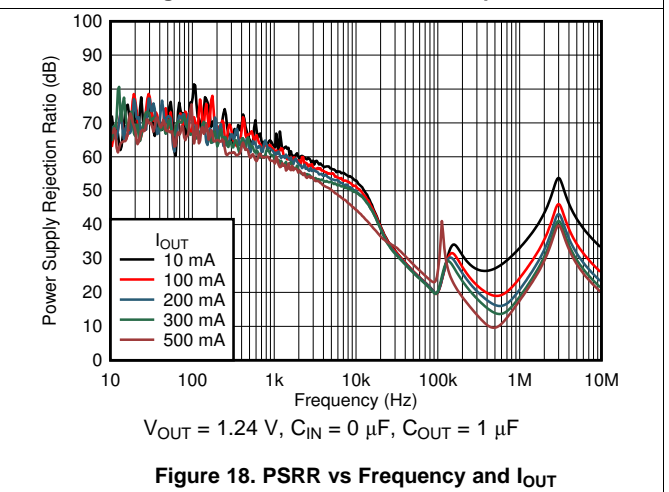
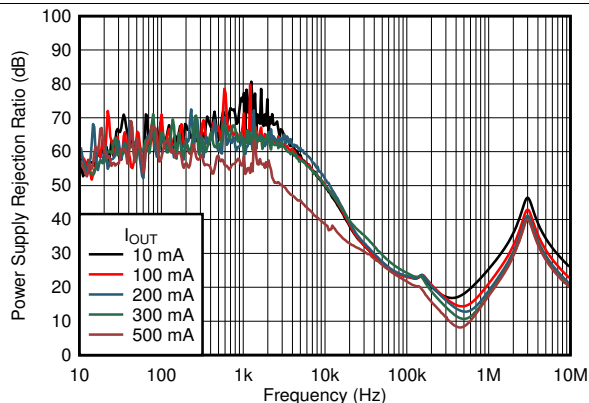

Figure 18. PSRR vs Frequency and  $I_{OUT}$



Typical Characteristics (continued)

at operating temperature  $T_J = 25^\circ\text{C}$ ,  $I_{OUT} = 1\text{ mA}$ ,  $V_{EN} = 0.9\text{ V}$ ,  $C_{IN} = 2.2\ \mu\text{F}$ ,  $C_{OUT} = 2.2\ \mu\text{F}$ , and  $V_{IN} = V_{OUT(\text{typ})} + 0.8\text{ V}$  or  $2.4\text{ V}$  (whichever is greater), unless otherwise noted; typical values are at  $T_J = 25^\circ\text{C}$



$V_{OUT} = 3.3\text{ V}$ ,  $V_{IN} = 4.3\text{ V}$ ,  
 $C_{IN} = 0\ \mu\text{F}$ ,  $C_{OUT} = 1\ \mu\text{F}$ ,  $C_{FF} = 10\text{ nF}$

Figure 19. PSRR vs Frequency and  $I_{OUT}$

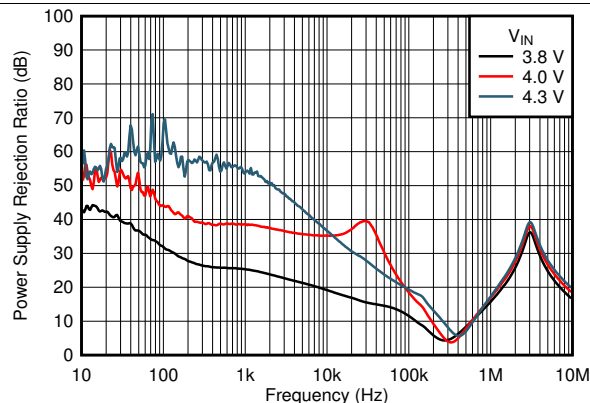

$V_{OUT} = 3.3\text{ V}$ ,  $I_{OUT} = 0.5\text{ A}$ ,  
 $C_{IN} = 0\ \mu\text{F}$ ,  $C_{OUT} = 1\ \mu\text{F}$ ,  $C_{FF} = 10\text{ nF}$

Figure 20. PSRR vs Frequency and  $V_{IN}$

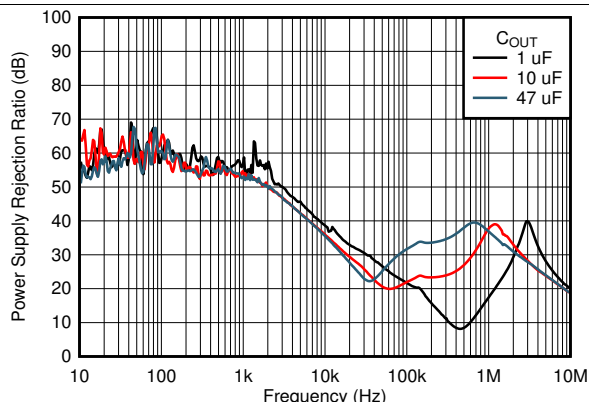

$V_{OUT} = 3.3\text{ V}$ ,  $V_{IN} = 4.3\text{ V}$ ,  $I_{OUT} = 0.5\text{ A}$ ,  
 $C_{IN} = 0\ \mu\text{F}$ ,  $C_{FF} = 10\text{ nF}$

Figure 21. PSRR vs Frequency and  $C_{OUT}$

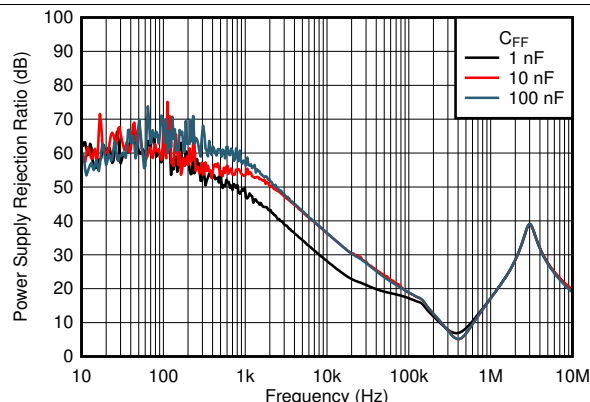

$V_{OUT} = 3.3\text{ V}$ ,  $V_{IN} = 4.3\text{ V}$ ,  $I_{OUT} = 0.5\text{ A}$ ,  
 $C_{IN} = 0\ \mu\text{F}$ ,  $C_{OUT} = 1\ \mu\text{F}$

Figure 22. PSRR vs Frequency and  $C_{FF}$

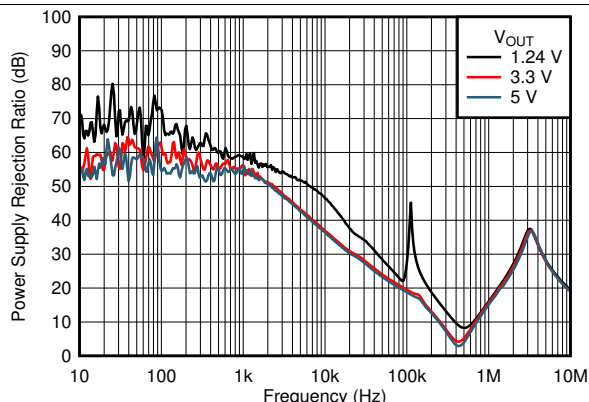

$V_{IN} = V_{OUT} + 1\text{ V}$  or  $2.4\text{ V}$  (whichever is greater),  $I_{OUT} = 0.5\text{ A}$ ,  
 $C_{IN} = 0\ \mu\text{F}$ ,  $C_{OUT} = 1\ \mu\text{F}$ ,  $C_{FF} = 10\text{ nF}$

Figure 23. PSRR vs Frequency and  $V_{OUT}$

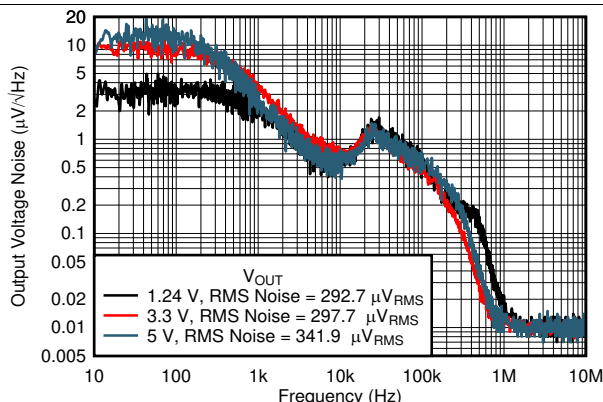

$V_{IN} = V_{OUT} + 1\text{ V}$  or  $2.4\text{ V}$  (whichever is greater),  
 $I_{OUT} = 0.5\text{ A}$ ,  $C_{IN} = 1\ \mu\text{F}$ ,  $C_{OUT} = 1\ \mu\text{F}$ ,  $C_{FF} = 10\text{ nF}$ ,  
 $V_{RMS}\text{ BW} = 10\text{ Hz to }100\text{ kHz}$

Figure 24. Output Noise ( $V_n$ ) vs Frequency and  $V_{OUT}$

Typical Characteristics (continued)

at operating temperature  $T_J = 25^\circ\text{C}$ ,  $I_{OUT} = 1\text{ mA}$ ,  $V_{EN} = 0.9\text{ V}$ ,  $C_{IN} = 2.2\ \mu\text{F}$ ,  $C_{OUT} = 2.2\ \mu\text{F}$ , and  $V_{IN} = V_{OUT(\text{typ})} + 0.8\text{ V}$  or  $2.4\text{ V}$  (whichever is greater), unless otherwise noted; typical values are at  $T_J = 25^\circ\text{C}$

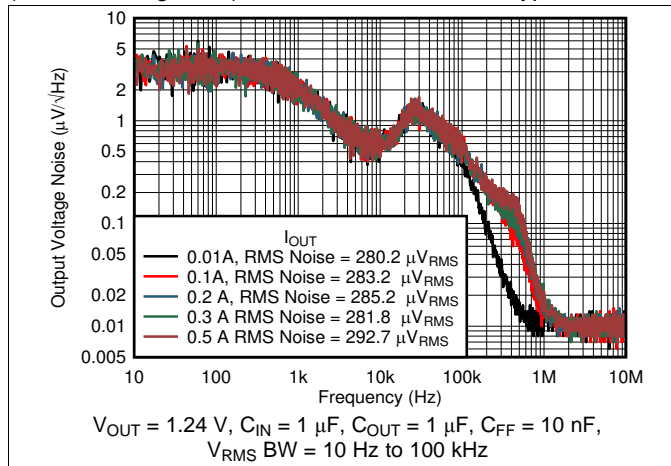

Figure 25. Output Noise ( $V_n$ ) vs Frequency and  $I_{OUT}$

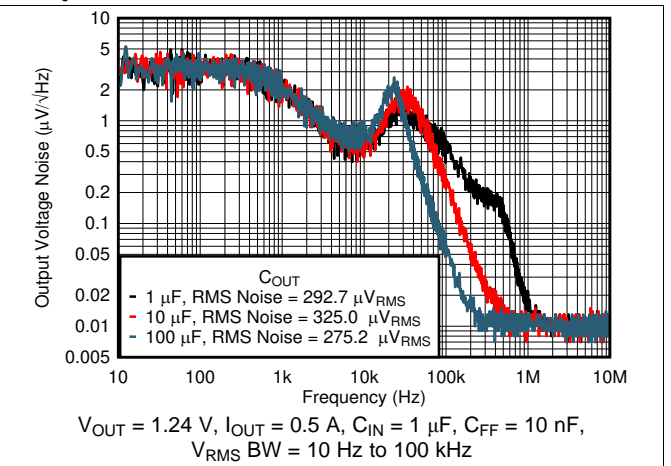

Figure 26. Output Noise ( $V_n$ ) vs Frequency and  $C_{OUT}$

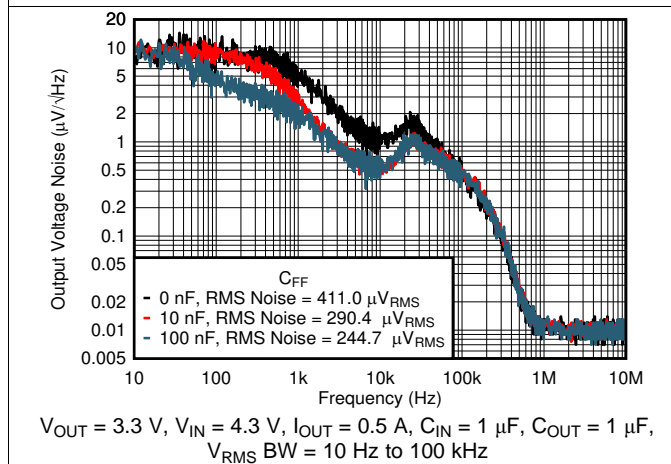

Figure 27. Output Noise ( $V_n$ ) vs Frequency and  $C_{FF}$

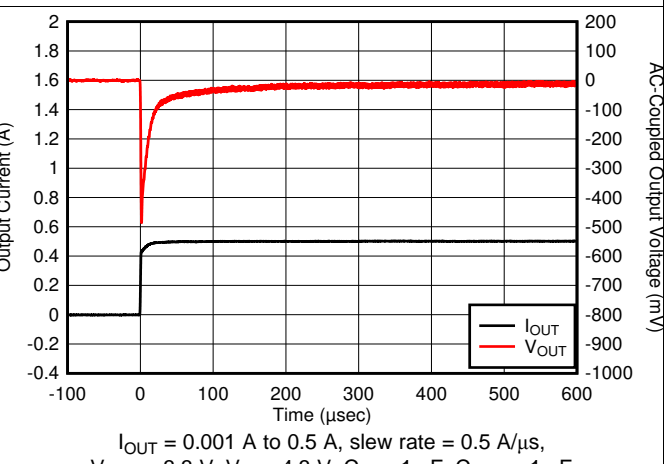

Figure 28. Load Transient

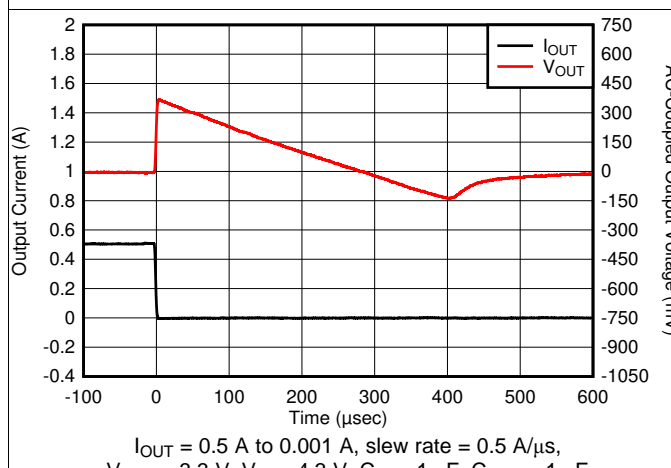

Figure 29. Load Transient

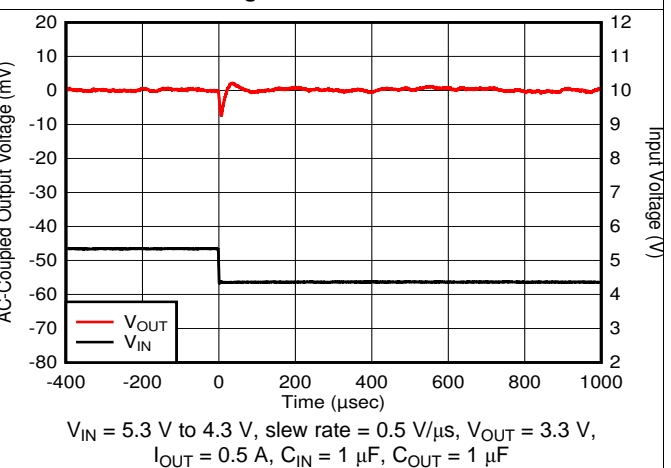

Figure 30. Line Transient

### Typical Characteristics (continued)

at operating temperature  $T_J = 25^\circ\text{C}$ ,  $I_{OUT} = 1\text{ mA}$ ,  $V_{EN} = 0.9\text{ V}$ ,  $C_{IN} = 2.2\ \mu\text{F}$ ,  $C_{OUT} = 2.2\ \mu\text{F}$ , and  $V_{IN} = V_{OUT(\text{typ})} + 0.8\text{ V}$  or  $2.4\text{ V}$  (whichever is greater), unless otherwise noted; typical values are at  $T_J = 25^\circ\text{C}$

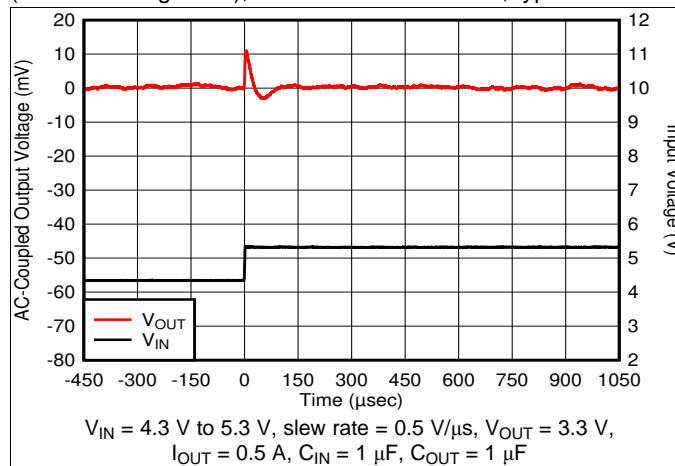

Figure 31. Line Transient

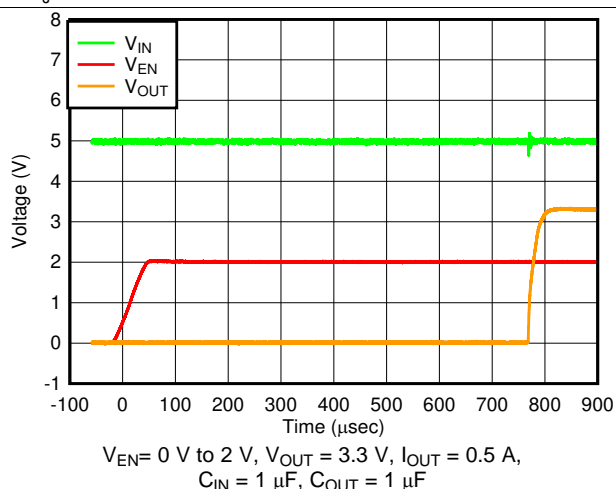

Figure 32. Start-Up With Enable

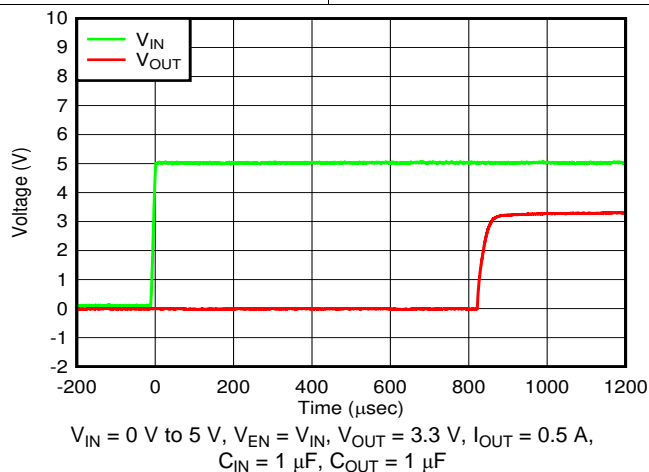

Figure 33. Start-Up With Enable Pin Tied to Input

## 7 Detailed Description

### 7.1 Overview

The TPS7A26 is an 18-V, low quiescent current, low-dropout (LDO) linear regulator. The low  $I_Q$  performance makes the TPS7A26 an excellent choice for battery-powered or line-power applications that are expected to meet increasingly stringent standby-power standards.

The 1% accuracy over temperature and power-good indication make this device an excellent choice for meeting a wide range of microcontroller power requirements.

For increased reliability, the TPS7A26 also incorporates overcurrent, overshoot pulldown, and thermal shutdown protection. The operating junction temperature is  $-40^{\circ}\text{C}$  to  $+125^{\circ}\text{C}$ , and adds margin for applications concerned with higher working ambient temperatures.

The TPS7A26 is available in a thermally enhanced WSON package.

### 7.2 Functional Block Diagram

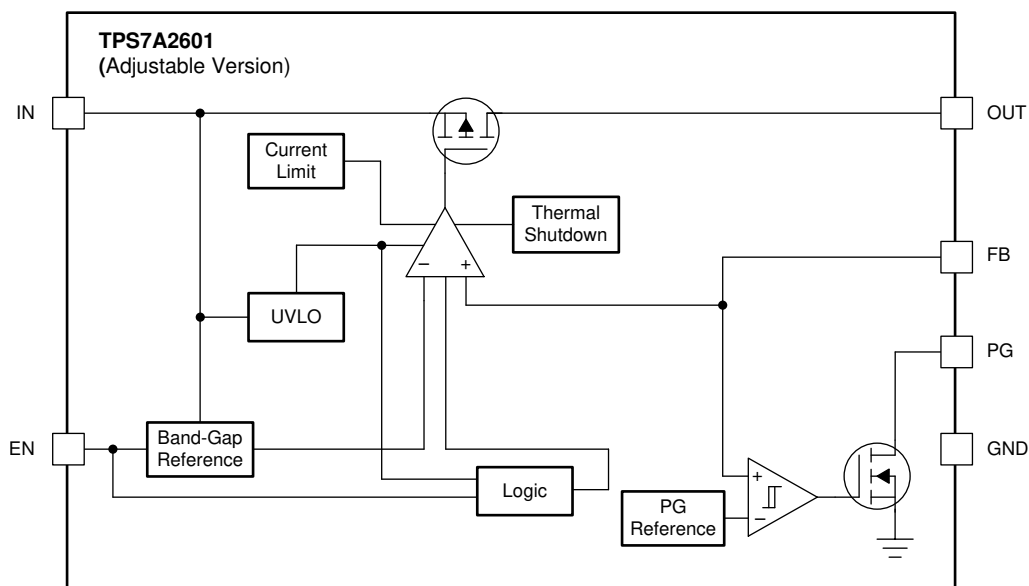

**Figure 34. Adjustable Version**

Functional Block Diagram (continued)

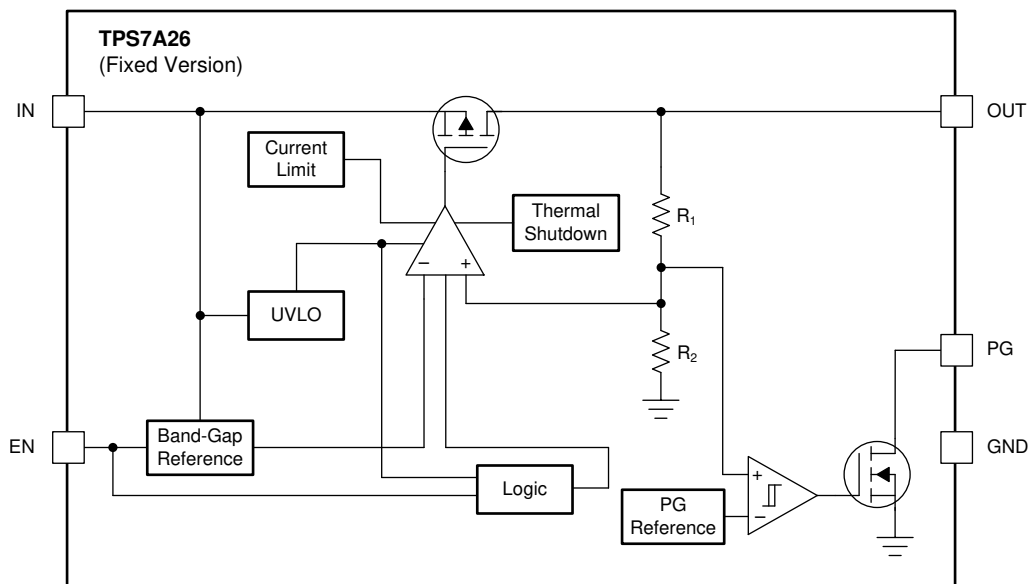

Figure 35. Fixed Version

7.3 Feature Description

7.3.1 Output Enable

The enable pin for the device is an active-high pin. The output voltage is enabled when the voltage of the enable pin is greater than the high-level input voltage of the EN pin and disabled with the enable pin voltage is less than the low-level input voltage of the EN pin. If independent control of the output voltage is not needed, connect the enable pin to the input of the device.

7.3.2 Dropout Voltage

Dropout voltage ( $V_{DO}$ ) is defined as the input voltage minus the output voltage ( $V_{IN} - V_{OUT}$ ) at the rated output current ( $I_{RATED}$ ), where the pass transistor is fully on.  $I_{RATED}$  is the maximum  $I_{OUT}$  listed in the *Recommended Operating Conditions* table. The pass transistor is in the ohmic or triode region of operation, and acts as a switch. The dropout voltage indirectly specifies a minimum input voltage greater than the nominal programmed output voltage at which the output voltage is expected to stay in regulation. If the input voltage falls to less than the nominal output regulation, then the output voltage falls as well.

## Feature Description (continued)

For a CMOS regulator, the dropout voltage is determined by the drain-source on-state resistance ( $R_{DS(ON)}$ ) of the pass transistor. Therefore, if the linear regulator operates at less than the rated current, the dropout voltage for that current scales accordingly. Use [Equation 1](#) to calculate the  $R_{DS(ON)}$  of the device.

$$R_{DS(ON)} = \frac{V_{DO}}{I_{RATED}} \quad (1)$$

### 7.3.3 Current Limit

The device has an internal current limit circuit that protects the regulator during transient high-load current faults or shorting events. The current limit is a brickwall scheme. In a high-load current fault, the brickwall scheme limits the output current to the current limit ( $I_{CL}$ ).  $I_{CL}$  is listed in the *Electrical Characteristics* table.

The output voltage is not regulated when the device is in current limit. When a current limit event occurs, the device begins to heat up because of the increase in power dissipation. When the device is in brickwall current limit, the pass transistor dissipates power  $[(V_{IN} - V_{OUT}) \times I_{CL}]$ . If thermal shutdown is triggered, the device turns off. After the device cools down, the internal thermal shutdown circuit turns the device back on. If the output current fault condition continues, the device cycles between current limit and thermal shutdown. For more information on current limits, see the [Know Your Limits application report](#).

[Figure 36](#) shows a diagram of the current limit.

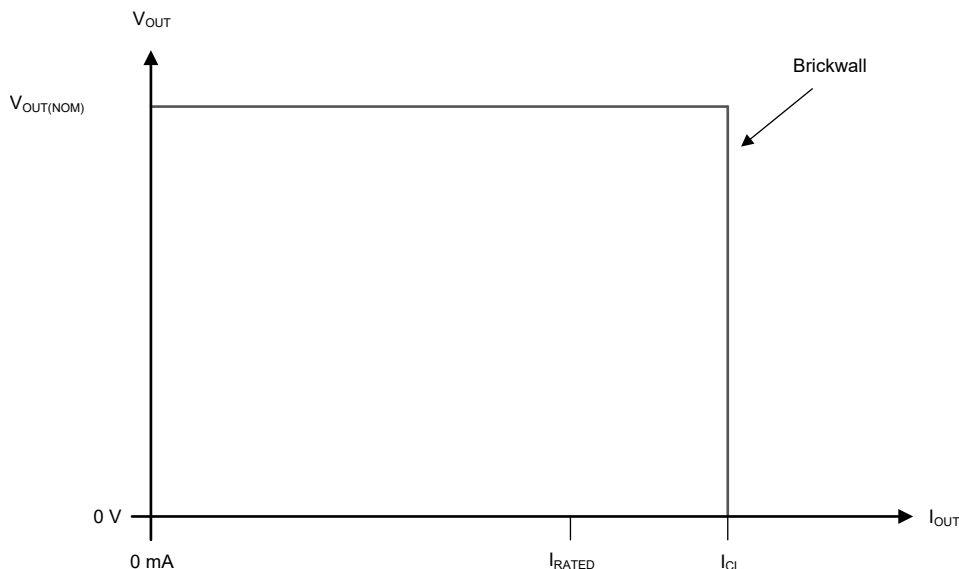

**Figure 36. Current Limit**

### 7.3.4 Undervoltage Lockout (UVLO)

The device has an independent undervoltage lockout (UVLO) circuit that monitors the input voltage, allowing a controlled and consistent turn on and off of the output voltage. To prevent the device from turning off if the input drops during turn on, the UVLO has hysteresis as specified in the *Electrical Characteristics* table.

### 7.3.5 Thermal Shutdown

The device contains a thermal shutdown protection circuit to disable the device when the junction temperature ( $T_J$ ) of the pass transistor rises to  $T_{SD(shutdown)}$  (typical). Thermal shutdown hysteresis assures that the device resets (turns on) when the temperature falls to  $T_{SD(reset)}$  (typical).

The thermal time-constant of the semiconductor die is fairly short, thus the device may cycle on and off when thermal shutdown is reached until power dissipation is reduced. Power dissipation during startup can be high from large  $V_{IN} - V_{OUT}$  voltage drops across the device or from high inrush currents charging large output capacitors. Under some conditions, the thermal shutdown protection disables the device before startup completes.

## Feature Description (continued)

When the thermal limit is triggered with load currents near the value of the current limit, the output may oscillate prior to the output switching off.

For reliable operation, limit the junction temperature to the maximum listed in the *Recommended Operating Conditions* table. Operation above this maximum temperature causes the device to exceed its operational specifications. Although the internal protection circuitry of the device is designed to protect against thermal overall conditions, this circuitry is not intended to replace proper heat sinking. Continuously running the device into thermal shutdown or above the maximum recommended junction temperature reduces long-term reliability.

### 7.3.6 Power Good

The power-good (PG) pin is an open-drain output and can be connected to a regulated supply through an external pullup resistor. The maximum pullup voltage is listed as  $V_{PG}$  in the *Recommended Operating Conditions* table. For the PG pin to have a valid output, the voltage on the IN pin must be greater than  $V_{UVLO(RISING)}$ , as listed in the *Electrical Characteristics* table. When the  $V_{OUT}$  exceeds  $V_{IT(PG,RISING)}$ , the PG output is high impedance and the PG pin voltage pulls up to the connected regulated supply. When the regulated output falls below  $V_{IT(PG,FALLING)}$ , the open-drain output turns on and pulls the PG output low after a short deglitch time. If output voltage monitoring is not needed, the PG pin can be left floating or connected to ground.

By connecting a pullup resistor to an external supply, any downstream device can receive power-good (PG) as a logic signal that can be used for sequencing. Make sure that the external pullup supply voltage results in a valid logic signal for the receiving device.

The recommended maximum PG pin sink current ( $I_{PG-SINK}$ ) and the leakage current into the PG pin ( $I_{LKG(PG)}$ ) are listed in the *Electrical Characteristics* table.

The PG pullup voltage ( $V_{PG\_PULLUP}$ ), the desired minimum power-good output voltage ( $V_{PG(MIN)}$ ), and  $I_{LKG(PG)}$  limit the maximum PG pin pullup resistor value ( $R_{PG\_PULLUP}$ ).  $V_{PG\_PULLUP}$ , the PG pin low-level output voltage ( $V_{OL(PG)}$ ), and  $I_{PG-SINK}$  limit the minimum  $R_{PG\_PULLUP}$ . Maximum and minimum values for  $R_{PG\_PULLUP}$  can be calculated from the following equations:

$$R_{PG\_PULLUP(MAX)} = (V_{PG\_PULLUP} - V_{PG(MIN)}) / I_{LKG(PG)_MAX} \quad (2)$$

$$R_{PG\_PULLUP(MIN)} = (V_{PG\_PULLUP} - V_{OL(PG)}) / I_{PG-SINK} \quad (3)$$

For example, if the PG pin is connected to a pullup resistor with a 3.3-V external supply, from [Equation 2](#),  $R_{PG\_PULLUP(MAX)}$  is 11 M $\Omega$ . From [Equation 3](#),  $R_{PG\_PULLUP(MIN)}$  is 5.8 k $\Omega$ .

### 7.3.7 Active Overshoot Pulldown Circuitry

This device has pulldown circuitry connected to  $V_{OUT}$ . This circuitry is a 100- $\mu$ A current sink, in series with a 5.5-k $\Omega$  resistor, controlled by  $V_{EN}$ . When  $V_{EN}$  is below  $V_{EN(LOW)}$ , the pulldown circuitry is disabled and the LDO output is in high-impedance mode.

If the output voltage is more than 60 mV above nominal voltage when  $V_{EN} \geq V_{EN(LOW)}$ , the pulldown circuitry turns on and the output is pulled down until the output voltage is within 60 mV from the nominal voltage. This feature helps reduce overshoot during the transient response.

## 7.4 Device Functional Modes

### 7.4.1 Device Functional Mode Comparison

The *Device Functional Mode Comparison* table shows the conditions that lead to the different modes of operation. See the *Electrical Characteristics* table for parameter values.

**Table 1. Device Functional Mode Comparison**

| OPERATING MODE                                       | PARAMETER   |                        |                          |                          |
|--|---|------------------------|--------------------------|--------------------------|
|  | $V_{IN}$  | $V_{EN}$               | $I_{OUT}$                | $T_J$                    |
| Normal operation                                     | $V_{IN} > V_{OUT(nom)} + V_{DO}$ and $V_{IN} > V_{IN(min)}$ | $V_{EN} > V_{EN(HI)}$  | $I_{OUT} < I_{OUT(max)}$ | $T_J < T_{SD(shutdown)}$ |
| Dropout operation                                    | $V_{IN(min)} < V_{IN} < V_{OUT(nom)} + V_{DO}$              | $V_{EN} > V_{EN(HI)}$  | $I_{OUT} < I_{OUT(max)}$ | $T_J < T_{SD(shutdown)}$ |
| Disabled<br>(any true condition disables the device) | $V_{IN} < V_{UVLO}$   | $V_{EN} < V_{EN(LOW)}$ | Not applicable           | $T_J > T_{SD(shutdown)}$ |

### 7.4.2 Normal Operation

The device regulates to the nominal output voltage when the following conditions are met:

- The input voltage is greater than the nominal output voltage plus the dropout voltage ( $V_{OUT(nom)} + V_{DO}$ )
- The output current is less than the current limit ( $I_{OUT} < I_{CL}$ )
- The device junction temperature is less than the thermal shutdown temperature ( $T_J < T_{SD}$ )
- The enable voltage has previously exceeded the enable rising threshold voltage and has not yet decreased to less than the enable falling threshold

### 7.4.3 Dropout Operation

If the input voltage is lower than the nominal output voltage plus the specified dropout voltage, but all other conditions are met for normal operation, the device operates in dropout mode. In this mode, the output voltage tracks the input voltage. During this mode, the transient performance of the device becomes significantly degraded because the pass transistor is in the ohmic or triode region, and acts as a switch. Line or load transients in dropout can result in large output-voltage deviations.

When the device is in a steady dropout state (defined as when the device is in dropout,  $V_{IN} < V_{OUT(NOM)} + V_{DO}$ , directly after being in a normal regulation state, but *not* during startup), the pass transistor is driven into the ohmic or triode region. When the input voltage returns to a value greater than or equal to the nominal output voltage plus the dropout voltage ( $V_{OUT(NOM)} + V_{DO}$ ), the output voltage can overshoot for a short period of time while the device pulls the pass transistor back into the linear region.

### 7.4.4 Disabled

The output of the device can be shutdown by forcing the voltage of the enable pin to less than the maximum EN pin low-level input voltage (see the *Electrical Characteristics* table). When disabled, the pass transistor is turned off and internal circuits are shutdown.



## 8 Application and Implementation

### NOTE

Information in the following applications sections is not part of the TI component specification, and TI does not warrant its accuracy or completeness. TI's customers are responsible for determining suitability of components for their purposes. Customers should validate and test their design implementation to confirm system functionality.

### 8.1 Application Information

#### 8.1.1 Adjustable Device Feedback Resistors

The adjustable-version device requires external feedback divider resistors to set the output voltage.  $V_{OUT}$  is set using the feedback divider resistors,  $R_1$  and  $R_2$ , according to the following equation:

$$V_{OUT} = V_{FB} \times (1 + R_1 / R_2) \quad (4)$$

To ignore the FB pin current error term in the  $V_{OUT}$  equation, set the feedback divider current to 100x the FB pin current listed in the *Electrical Characteristics* table. This setting provides the maximum feedback divider series resistance, as shown in the following equation:

$$R_1 + R_2 \leq V_{OUT} / (I_{FB} \times 100) \quad (5)$$

#### 8.1.2 Recommended Capacitor Types

The device is designed to be stable using low equivalent series resistance (ESR) capacitors at the input and output. Multilayer ceramic capacitors have become the industry standard for these types of applications and are recommended, but must be used with good judgment. Ceramic capacitors that employ X7R-, X5R-, and C0G-rated dielectric materials provide relatively good capacitive stability across temperature, whereas the use of Y5V-rated capacitors is discouraged because of large variations in capacitance.

Regardless of the ceramic capacitor type selected, the effective capacitance varies with operating voltage and temperature. As a rule of thumb, expect the effective capacitance to decrease by as much as 50%. The input and output capacitors recommended in the *Recommended Operating Conditions* table account for an effective capacitance of approximately 50% of the nominal value.

#### 8.1.3 Input and Output Capacitor Requirements

Although an input capacitor is not required for stability, good analog design practice is to connect a capacitor from IN to GND. This capacitor counteracts reactive input sources and improves transient response, input ripple, and PSRR. An input capacitor is recommended if the source impedance is more than 0.5  $\Omega$ . A higher value capacitor may be necessary if large, fast load transient or line transients are anticipated or if the device is located several inches from the input power source.

Dynamic performance of the device is improved with the use of an output capacitor. Use an output capacitor within the range specified in the *Recommended Operating Conditions* table for stability.

The effective output capacitance value is recommended to not exceed 50  $\mu$ F.

#### 8.1.4 Reverse Current

Excessive reverse current can damage this device. Reverse current flows through the intrinsic body diode of the pass transistor instead of the normal conducting channel. At high magnitudes, this current flow degrades the long-term reliability of the device.

Conditions where reverse current can occur are outlined in this section, all of which can exceed the absolute maximum rating of  $V_{OUT} \leq V_{IN} + 0.3$  V.

- If the device has a large  $C_{OUT}$  and the input supply collapses with little or no load current
- The output is biased when the input supply is not established
- The output is biased above the input supply

### Application Information (continued)

If reverse current flow is expected in the application, external protection is recommended to protect the device. Reverse current is not limited in the device, so external limiting is required if extended reverse voltage operation is anticipated.

Figure 37 shows one approach for protecting the device.

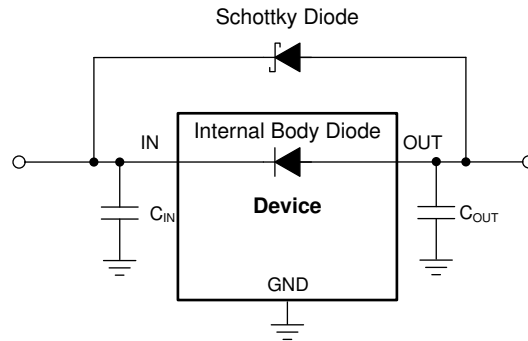

Figure 37. Example Circuit for Reverse Current Protection Using a Schottky Diode

Figure 38 shows another, more commonly used, approach in high input voltage applications.

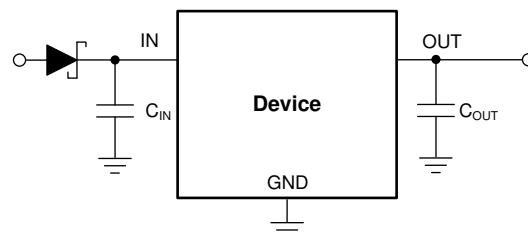

Figure 38. Reverse Current Prevention Using A Diode Before the LDO

#### 8.1.5 Feed-Forward Capacitor (C<sub>FF</sub>)

For the adjustable-voltage version device, a feed-forward capacitor (C<sub>FF</sub>) can be connected from the OUT pin to the FB pin. C<sub>FF</sub> improves transient, noise, and PSRR performance, but is not required for regulator stability. Recommended C<sub>FF</sub> values are listed in the *Recommended Operating Conditions* table. A higher capacitance C<sub>FF</sub> can be used; however, the startup time increases. For a detailed description of C<sub>FF</sub> tradeoffs, see the [Pros and Cons of Using a Feedforward Capacitor with a Low-Dropout Regulator](#) application report.

#### 8.1.6 Power Dissipation (P<sub>D</sub>)

Circuit reliability requires consideration of the device power dissipation, location of the circuit on the printed circuit board (PCB), and correct sizing of the thermal plane. The PCB area around the regulator must have few or no other heat-generating devices that cause added thermal stress.

To first-order approximation, power dissipation in the regulator depends on the input-to-output voltage difference and load conditions. Equation 6 calculates power dissipation (P<sub>D</sub>).

$$P_D = (V_{IN} - V_{OUT}) \times I_{OUT} \tag{6}$$

#### NOTE

Power dissipation can be minimized, and therefore greater efficiency can be achieved, by correct selection of the system voltage rails. For the lowest power dissipation use the minimum input voltage required for correct output regulation.

## Application Information (continued)

For devices with a thermal pad, the primary heat conduction path for the device package is through the thermal pad to the PCB. Solder the thermal pad to a copper pad area under the device. This pad area must contain an array of plated vias that conduct heat to additional copper planes for increased heat dissipation.

The maximum power dissipation determines the maximum allowable ambient temperature ( $T_A$ ) for the device. According to [Equation 7](#), power dissipation and junction temperature are most often related by the junction-to-ambient thermal resistance ( $R_{\theta JA}$ ) of the combined PCB and device package and the temperature of the ambient air ( $T_A$ ).

$$T_J = T_A + (R_{\theta JA} \times P_D) \quad (7)$$

Thermal resistance ( $R_{\theta JA}$ ) is highly dependent on the heat-spreading capability built into the particular PCB design, and therefore varies according to the total copper area, copper weight, and location of the planes. The junction-to-ambient thermal resistance listed in the *Thermal Information* table is determined by the JEDEC standard PCB and copper-spreading area, and is used as a relative measure of package thermal performance.

### 8.1.7 Estimating Junction Temperature

The JEDEC standard now recommends the use of psi ( $\Psi$ ) thermal metrics to estimate the junction temperatures of the linear regulator when in-circuit on a typical PCB board application. These metrics are not thermal resistance parameters and instead offer a practical and relative way to estimate junction temperature. These psi metrics are determined to be significantly independent of the copper area available for heat-spreading. The *Thermal Information* table lists the primary thermal metrics, which are the junction-to-top characterization parameter ( $\Psi_{JT}$ ) and junction-to-board characterization parameter ( $\Psi_{JB}$ ). These parameters provide two methods for calculating the junction temperature ( $T_J$ ). As described in , use the junction-to-top characterization parameter ( $\Psi_{JT}$ ) with the temperature at the center-top of device package ( $T_T$ ) to calculate the junction temperature. As described in , use the junction-to-board characterization parameter ( $\Psi_{JB}$ ) with the PCB surface temperature 1 mm from the device package ( $T_B$ ) to calculate the junction temperature.

$$T_J = T_T + \Psi_{JT} \times P_D$$

where:

- $P_D$  is the dissipated power
- $T_T$  is the temperature at the center-top of the device package

$$T_J = T_B + \Psi_{JB} \times P_D$$

where

- $T_B$  is the PCB surface temperature measured 1 mm from the device package and centered on the package edge

For detailed information on the thermal metrics and how to use them, see the [Semiconductor and IC Package Thermal Metrics application report](#).

## Application Information (continued)

### 8.1.8 Special Consideration for Line Transient

During a line transient, the response of this LDO to a very large or fast input voltage change can cause a brief shutdown lasting up to a few hundred microseconds from the voltage transition. This shutdown can be avoided by reducing the voltage step size, increasing the transition time, or a combination of both. Figure 39 provides a boundary to follow to avoid this behavior. If necessary, reduce slew rate and the voltage step size to stay below the curve.

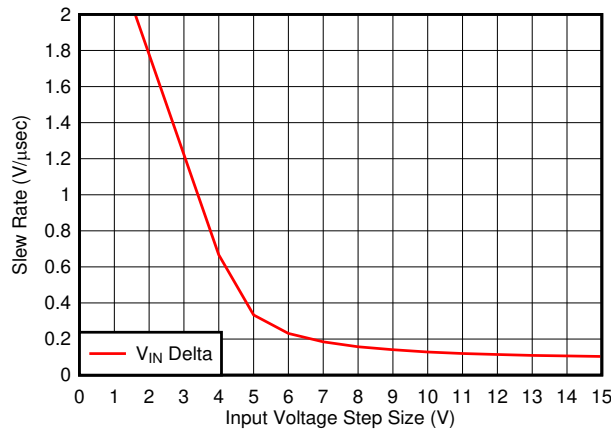

Figure 39. Recommended Input Voltage Step and Slew Rate in a Line transient

## 8.2 Typical Application

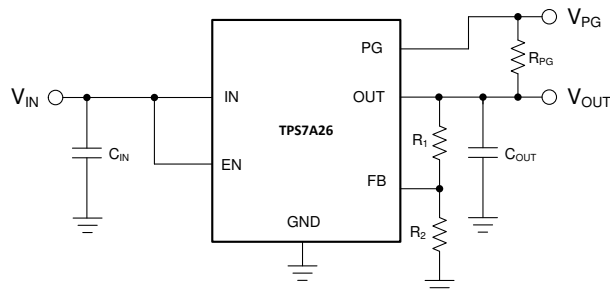

Figure 40. Generating a 5-V Rail From a Multicell Power Bank

### 8.2.1 Design Requirements

Table 2 summarizes the design requirements for Figure 40.

Table 2. Design Parameters

| PARAMETER            | DESIGN VALUES |
|----------------------|---------------|
| $V_{IN}$             | 7.2 V         |
| $V_{OUT}$            | 5 V $\pm$ 1%  |
| $I_{(IN)}$ (no load) | < 5 $\mu$ A   |
| $I_{OUT}$ (max)      | 330 mA        |
| $T_A$                | 70°C (max)    |

## 8.2.2 Detailed Design Procedure

Select a 5-V output, fixed or adjustable device to generate the 5-V rail. The fixed-version LDO has internal feedback divider resistors, and thus has lower quiescent current. The adjustable-version LDO requires external feedback divider resistors, and is described in the [Selecting Feedback Divider Resistors](#) section.

### 8.2.2.1 Transient Response

As with any regulator, increasing the output capacitor value reduces over- and undershoot magnitude, but increases transient response duration.

### 8.2.2.2 Selecting Feedback Divider Resistors

For this design example,  $V_{OUT}$  is set to 5 V. The following equations set the output voltage:

$$V_{OUT} = V_{FB} \times (1 + R_1 / R_2) \quad (10)$$

$$R_1 + R_2 \leq V_{OUT} / (I_{FB} \times 100) \quad (11)$$

For improved output accuracy, use [Equation 11](#) and  $I_{FB(TYP)} = 10$  nA as listed in the [Electrical Characteristics](#) table to calculate the upper limit for series feedback resistance,  $R_1 + R_2 \leq 5$  M $\Omega$ .

The control-loop error amplifier drives the FB pin to the same voltage as the internal reference ( $V_{FB} = 1.24$  V as listed in the [Electrical Characteristics](#) table). Use [Equation 10](#) to determine the ratio of  $R_1 / R_2 = 3.03$ . Use this ratio and solve [Equation 11](#) for  $R_2$ . Now calculate the upper limit for  $R_2 \leq 1.24$  M $\Omega$ . Select a standard value resistor of  $R_2 = 1.18$  M $\Omega$ .

Reference [Equation 10](#) and solve for  $R_1$ :

$$R_1 = (V_{OUT} / V_{FB} - 1) \times R_2 \quad (12)$$

From [Equation 12](#),  $R_1 = 3.64$  M $\Omega$  can be determined. Select a standard resistor value for  $R_1 = 3.6$  M $\Omega$ . From [Equation 10](#), select  $V_{OUT} = 5.023$  V.

### 8.2.2.3 Thermal Dissipation

Junction temperature can be determined using the junction-to-ambient thermal resistance ( $R_{\theta JA}$ ) and the total power dissipation ( $P_D$ ). Use [Equation 13](#) to calculate the power dissipation. Multiply  $P_D$  by  $R_{\theta JA}$  and add the ambient temperature ( $T_A$ ), as [Equation 14](#) shows, to calculate the junction temperature ( $T_J$ ).

$$P_D = (I_{GND} + I_{OUT}) \times (V_{IN} - V_{OUT}) \quad (13)$$

$$T_J = R_{\theta JA} \times P_D + T_A \quad (14)$$

[Equation 15](#) calculates the maximum ambient temperature. [Equation 16](#) calculates the maximum ambient temperature for typical design applications.

$$T_{A(MAX)} = T_{J(MAX)} - (R_{\theta JA} \times P_D) \quad (15)$$

$$T_{A(MAX)} = 125^\circ\text{C} - [73.3^\circ\text{C/W} \times (7.2 \text{ V} - 5 \text{ V}) \times 0.33 \text{ A}] = 71.8^\circ\text{C} \quad (16)$$

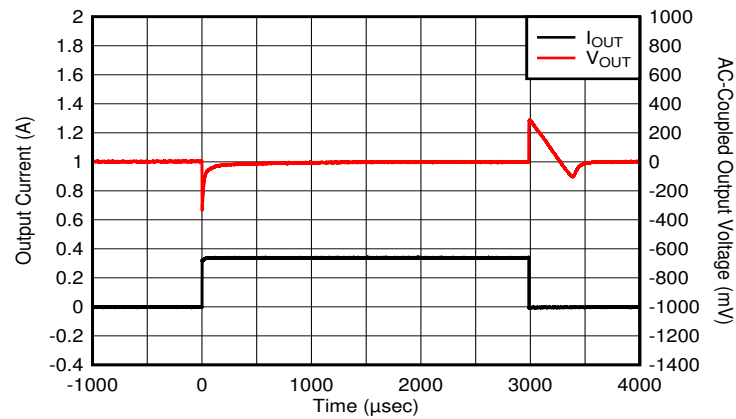
**8.2.3 Application Curve**

$I_{OUT} = 1 \text{ mA to } 0.33 \text{ A}$ , slew rate =  $0.5 \text{ A}/\mu\text{s}$ ,  
 $V_{OUT} = 5 \text{ V}$ ,  $V_{IN} = 7.2 \text{ V}$ ,  $C_{IN} = 1 \mu\text{F}$ ,  $C_{OUT} = 1 \mu\text{F}$ ,  $C_{FF} = 0 \mu\text{F}$

**Figure 41. TPS7A26 Load Transient 1 mA to 330 mA)**

## 9 Power Supply Recommendations

The device is designed to operate with an input supply range of 2.4 V to 18 V. If the input supply is noisy, additional input capacitors with low ESR can help improve output noise performance.

## 10 Layout

### 10.1 Layout Guidelines

- Place input and output capacitors as close to the device pins as possible
- Use copper planes for device connections to optimize thermal performance
- Place thermal vias around the device and under the DRV thermal pad to distribute heat

### 10.2 Layout Examples

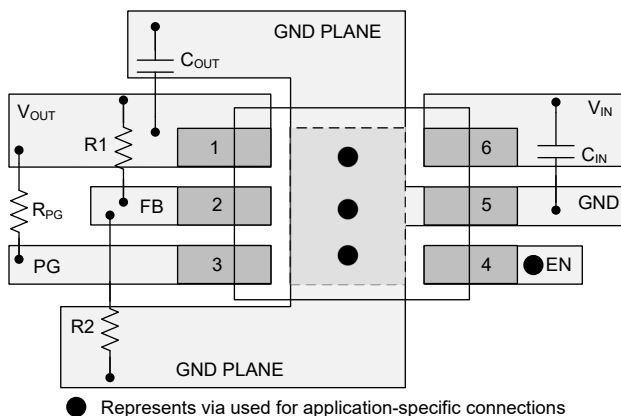

**Figure 42. Adjustable Version Layout Example**

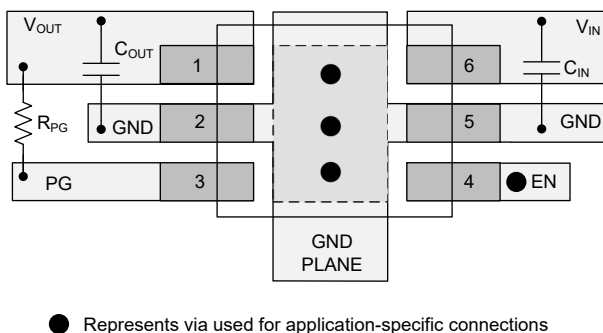

**Figure 43. Fixed Version Layout Example**

## 11 Device and Documentation Support

### 11.1 Device Support

#### 11.1.1 Device Nomenclature

Table 3. Device Nomenclature<sup>(1)</sup>

| PRODUCT          | V <sub>OUT</sub>   |
|------------------|--|
| TPS7A26xx(x)yyyz | <p><b>xx(x)</b> is the nominal output voltage. For output voltages with a resolution of 100 mV, two digits are used in the ordering number; for output voltages with a resolution of 50 mV, three digits are used (for example, 28 = 2.8 V; 125 = 1.25 V). 01 indicates adjustable output version.</p> <p><b>yyy</b> is the package designator.</p> <p><b>z</b> is the package quantity. R is for large quantity reel, T is for small quantity reel.</p> |

(1) For the most current package and ordering information see the Package Option Addendum at the end of this document, or visit the device product folder at [www.ti.com](http://www.ti.com).

### 11.2 Documentation Support

#### 11.2.1 Related Documentation

- Texas Instruments, [TPS7A25 300-mA, 18-V, Ultra-Low-IQ, Low-Dropout Linear Voltage Regulator With Power-Good data sheet](#)
- Texas Instruments, [Know Your Limits application report](#)
- Texas Instruments, [Pros and Cons of Using a Feedforward Capacitor with a Low-Dropout Regulator application report](#)

### 11.3 Receiving Notification of Documentation Updates

To receive notification of documentation updates, navigate to the device product folder on ti.com. In the upper right corner, click on *Alert me* to register and receive a weekly digest of any product information that has changed. For change details, review the revision history included in any revised document.

### 11.4 Community Resources

[TI E2E™ support forums](#) are an engineer's go-to source for fast, verified answers and design help — straight from the experts. Search existing answers or ask your own question to get the quick design help you need.

Linked content is provided "AS IS" by the respective contributors. They do not constitute TI specifications and do not necessarily reflect TI's views; see TI's [Terms of Use](#).

### 11.5 Trademarks

E2E is a trademark of Texas Instruments.

All other trademarks are the property of their respective owners.

### 11.6 Electrostatic Discharge Caution



This integrated circuit can be damaged by ESD. Texas Instruments recommends that all integrated circuits be handled with appropriate precautions. Failure to observe proper handling and installation procedures can cause damage.

ESD damage can range from subtle performance degradation to complete device failure. Precision integrated circuits may be more susceptible to damage because very small parametric changes could cause the device not to meet its published specifications.

### 11.7 Glossary

[SLYZ022](#) — *TI Glossary*.

This glossary lists and explains terms, acronyms, and definitions.

## 12 Mechanical, Packaging, and Orderable Information

The following pages include mechanical, packaging, and orderable information. This information is the most current data available for the designated devices. This data is subject to change without notice and revision of this document. For browser-based versions of this data sheet, refer to the left-hand navigation.



**PACKAGING INFORMATION**

| Orderable Device | Status<br>(1) | Package Type | Package Drawing | Pins | Package Qty | Eco Plan<br>(2) | Lead finish/<br>Ball material<br>(6) | MSL Peak Temp<br>(3) | Op Temp (°C) | Device Marking<br>(4/5) | Samples                 |
|------------------|---------------|--------------|-----------------|------|-------------|-----------------|--------------------------------------|----------------------|--------------|-------------------------|-------------------------|
| TPS7A2601DRVR    | ACTIVE        | WSON         | DRV             | 6    | 3000        | RoHS & Green    | NIPDAU                               | Level-1-260C-UNLIM   | -40 to 125   | 7A26                    | <a href="#">Samples</a> |
| TPS7A2601DRVT    | ACTIVE        | WSON         | DRV             | 6    | 250         | RoHS & Green    | NIPDAU                               | Level-1-260C-UNLIM   | -40 to 125   | 7A26                    | <a href="#">Samples</a> |
| TPS7A26125DRVR   | ACTIVE        | WSON         | DRV             | 6    | 3000        | RoHS & Green    | NIPDAU                               | Level-1-260C-UNLIM   | -40 to 125   | 1X9P                    | <a href="#">Samples</a> |
| TPS7A2618DRVR    | ACTIVE        | WSON         | DRV             | 6    | 3000        | RoHS & Green    | NIPDAU                               | Level-1-260C-UNLIM   | -40 to 125   | 1X8P                    | <a href="#">Samples</a> |
| TPS7A2625DRVR    | ACTIVE        | WSON         | DRV             | 6    | 3000        | RoHS & Green    | NIPDAU                               | Level-1-260C-UNLIM   | -40 to 125   | 1X7P                    | <a href="#">Samples</a> |
| TPS7A2633DRVR    | ACTIVE        | WSON         | DRV             | 6    | 3000        | RoHS & Green    | NIPDAU                               | Level-1-260C-UNLIM   | -40 to 125   | 1WRP                    | <a href="#">Samples</a> |
| TPS7A2650DRVR    | ACTIVE        | WSON         | DRV             | 6    | 3000        | RoHS & Green    | NIPDAU                               | Level-1-260C-UNLIM   | -40 to 125   | 1WPP                    | <a href="#">Samples</a> |

(1) The marketing status values are defined as follows:

**ACTIVE:** Product device recommended for new designs.

**LIFEBUY:** TI has announced that the device will be discontinued, and a lifetime-buy period is in effect.

**NRND:** Not recommended for new designs. Device is in production to support existing customers, but TI does not recommend using this part in a new design.

**PREVIEW:** Device has been announced but is not in production. Samples may or may not be available.

**OBSOLETE:** TI has discontinued the production of the device.

(2) **RoHS:** TI defines "RoHS" to mean semiconductor products that are compliant with the current EU RoHS requirements for all 10 RoHS substances, including the requirement that RoHS substance do not exceed 0.1% by weight in homogeneous materials. Where designed to be soldered at high temperatures, "RoHS" products are suitable for use in specified lead-free processes. TI may reference these types of products as "Pb-Free".

**RoHS Exempt:** TI defines "RoHS Exempt" to mean products that contain lead but are compliant with EU RoHS pursuant to a specific EU RoHS exemption.

**Green:** TI defines "Green" to mean the content of Chlorine (Cl) and Bromine (Br) based flame retardants meet JS709B low halogen requirements of <=1000ppm threshold. Antimony trioxide based flame retardants must also meet the <=1000ppm threshold requirement.

(3) MSL, Peak Temp. - The Moisture Sensitivity Level rating according to the JEDEC industry standard classifications, and peak solder temperature.

(4) There may be additional marking, which relates to the logo, the lot trace code information, or the environmental category on the device.

(5) Multiple Device Markings will be inside parentheses. Only one Device Marking contained in parentheses and separated by a "-" will appear on a device. If a line is indented then it is a continuation of the previous line and the two combined represent the entire Device Marking for that device.

<sup>(6)</sup> Lead finish/Ball material - Orderable Devices may have multiple material finish options. Finish options are separated by a vertical ruled line. Lead finish/Ball material values may wrap to two lines if the finish value exceeds the maximum column width.

**Important Information and Disclaimer:**The information provided on this page represents TI's knowledge and belief as of the date that it is provided. TI bases its knowledge and belief on information provided by third parties, and makes no representation or warranty as to the accuracy of such information. Efforts are underway to better integrate information from third parties. TI has taken and continues to take reasonable steps to provide representative and accurate information but may not have conducted destructive testing or chemical analysis on incoming materials and chemicals. TI and TI suppliers consider certain information to be proprietary, and thus CAS numbers and other limited information may not be available for release.

In no event shall TI's liability arising out of such information exceed the total purchase price of the TI part(s) at issue in this document sold by TI to Customer on an annual basis.

**TAPE AND REEL INFORMATION**

**QUADRANT ASSIGNMENTS FOR PIN 1 ORIENTATION IN TAPE**

\*All dimensions are nominal

| Device         | Package Type | Package Drawing | Pins | SPQ  | Reel Diameter (mm) | Reel Width W1 (mm) | A0 (mm) | B0 (mm) | K0 (mm) | P1 (mm) | W (mm) | Pin1 Quadrant |
|----------------|--------------|-----------------|------|------|--------------------|--------------------|---------|---------|---------|---------|--------|---------------|
| TPS7A2601DRVR  | WSON         | DRV             | 6    | 3000 | 178.0              | 8.4                | 2.25    | 2.25    | 1.0     | 4.0     | 8.0    | Q2            |
| TPS7A2601DRVT  | WSON         | DRV             | 6    | 250  | 178.0              | 8.4                | 2.25    | 2.25    | 1.0     | 4.0     | 8.0    | Q2            |
| TPS7A26125DRVR | WSON         | DRV             | 6    | 3000 | 178.0              | 8.4                | 2.25    | 2.25    | 1.0     | 4.0     | 8.0    | Q2            |
| TPS7A2618DRVR  | WSON         | DRV             | 6    | 3000 | 178.0              | 8.4                | 2.25    | 2.25    | 1.0     | 4.0     | 8.0    | Q2            |
| TPS7A2625DRVR  | WSON         | DRV             | 6    | 3000 | 178.0              | 8.4                | 2.25    | 2.25    | 1.0     | 4.0     | 8.0    | Q2            |
| TPS7A2633DRVR  | WSON         | DRV             | 6    | 3000 | 178.0              | 8.4                | 2.25    | 2.25    | 1.0     | 4.0     | 8.0    | Q2            |
| TPS7A2650DRVR  | WSON         | DRV             | 6    | 3000 | 178.0              | 8.4                | 2.25    | 2.25    | 1.0     | 4.0     | 8.0    | Q2            |

**TAPE AND REEL BOX DIMENSIONS**

\*All dimensions are nominal

| Device         | Package Type | Package Drawing | Pins | SPQ  | Length (mm) | Width (mm) | Height (mm) |
|----------------|--------------|-----------------|------|------|-------------|------------|-------------|
| TPS7A2601DRVR  | WSON         | DRV             | 6    | 3000 | 205.0       | 200.0      | 33.0        |
| TPS7A2601DRVT  | WSON         | DRV             | 6    | 250  | 205.0       | 200.0      | 33.0        |
| TPS7A26125DRVR | WSON         | DRV             | 6    | 3000 | 205.0       | 200.0      | 33.0        |
| TPS7A2618DRVR  | WSON         | DRV             | 6    | 3000 | 205.0       | 200.0      | 33.0        |
| TPS7A2625DRVR  | WSON         | DRV             | 6    | 3000 | 205.0       | 200.0      | 33.0        |
| TPS7A2633DRVR  | WSON         | DRV             | 6    | 3000 | 205.0       | 200.0      | 33.0        |
| TPS7A2650DRVR  | WSON         | DRV             | 6    | 3000 | 205.0       | 200.0      | 33.0        |

## GENERIC PACKAGE VIEW

DRV 6

WSON - 0.8 mm max height

PLASTIC SMALL OUTLINE - NO LEAD



Images above are just a representation of the package family, actual package may vary.  
Refer to the product data sheet for package details.

4206925/F

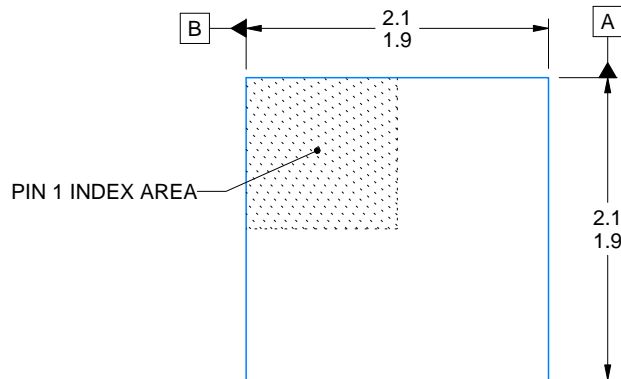
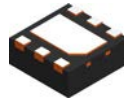

4222173/B 04/2018

NOTES:

1. All linear dimensions are in millimeters. Any dimensions in parenthesis are for reference only. Dimensioning and tolerancing per ASME Y14.5M.
2. This drawing is subject to change without notice.
3. The package thermal pad must be soldered to the printed circuit board for thermal and mechanical performance.

# EXAMPLE BOARD LAYOUT

DRV0006A

WSON - 0.8 mm max height

PLASTIC SMALL OUTLINE - NO LEAD

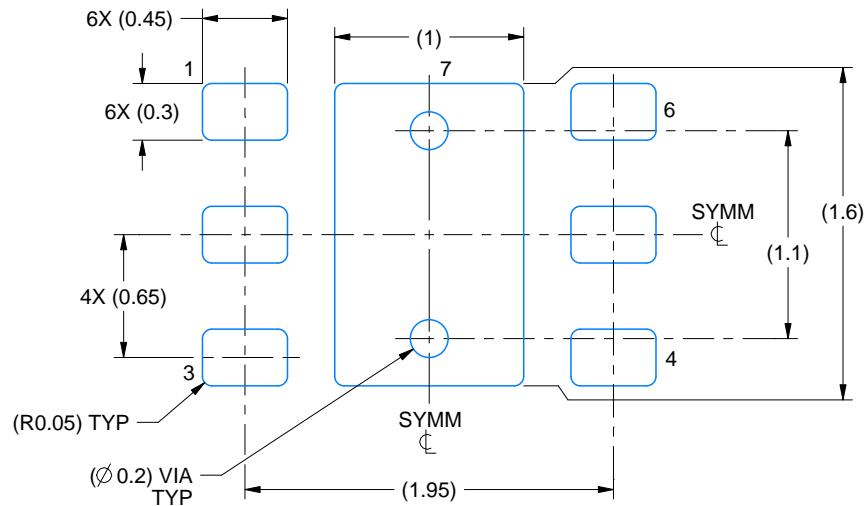

LAND PATTERN EXAMPLE  
SCALE:25X

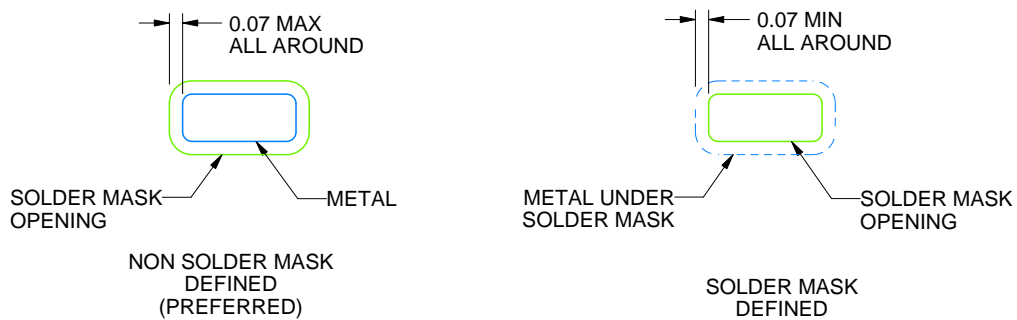

SOLDER MASK DETAILS

4222173/B 04/2018

NOTES: (continued)

4. This package is designed to be soldered to a thermal pad on the board. For more information, see Texas Instruments literature number SLUA271 ([www.ti.com/lit/sluea271](http://www.ti.com/lit/sluea271)).
5. Vias are optional depending on application, refer to device data sheet. If some or all are implemented, recommended via locations are shown.

# EXAMPLE STENCIL DESIGN

DRV0006A

WSON - 0.8 mm max height

PLASTIC SMALL OUTLINE - NO LEAD



SOLDER PASTE EXAMPLE  
BASED ON 0.125 mm THICK STENCIL

EXPOSED PAD #7  
88% PRINTED SOLDER COVERAGE BY AREA UNDER PACKAGE  
SCALE:30X

4222173/B 04/2018

NOTES: (continued)

6. Laser cutting apertures with trapezoidal walls and rounded corners may offer better paste release. IPC-7525 may have alternate design recommendations.



## IMPORTANT NOTICE AND DISCLAIMER

TI PROVIDES TECHNICAL AND RELIABILITY DATA (INCLUDING DATASHEETS), DESIGN RESOURCES (INCLUDING REFERENCE DESIGNS), APPLICATION OR OTHER DESIGN ADVICE, WEB TOOLS, SAFETY INFORMATION, AND OTHER RESOURCES "AS IS" AND WITH ALL FAULTS, AND DISCLAIMS ALL WARRANTIES, EXPRESS AND IMPLIED, INCLUDING WITHOUT LIMITATION ANY IMPLIED WARRANTIES OF MERCHANTABILITY, FITNESS FOR A PARTICULAR PURPOSE OR NON-INFRINGEMENT OF THIRD PARTY INTELLECTUAL PROPERTY RIGHTS.

These resources are intended for skilled developers designing with TI products. You are solely responsible for (1) selecting the appropriate TI products for your application, (2) designing, validating and testing your application, and (3) ensuring your application meets applicable standards, and any other safety, security, or other requirements. These resources are subject to change without notice. TI grants you permission to use these resources only for development of an application that uses the TI products described in the resource. Other reproduction and display of these resources is prohibited. No license is granted to any other TI intellectual property right or to any third party intellectual property right. TI disclaims responsibility for, and you will fully indemnify TI and its representatives against, any claims, damages, costs, losses, and liabilities arising out of your use of these resources.

TI's products are provided subject to TI's Terms of Sale ([www.ti.com/legal/termsofsale.html](http://www.ti.com/legal/termsofsale.html)) or other applicable terms available either on [ti.com](http://ti.com) or provided in conjunction with such TI products. TI's provision of these resources does not expand or otherwise alter TI's applicable warranties or warranty disclaimers for TI products.

Mailing Address: Texas Instruments, Post Office Box 655303, Dallas, Texas 75265  
Copyright © 2020, Texas Instruments Incorporated