

FRONT SHELL

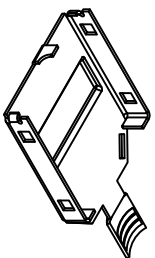

INSERTED BODY

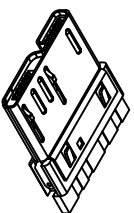

REAR SHELL

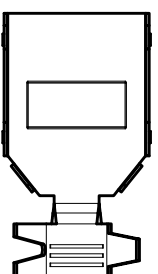
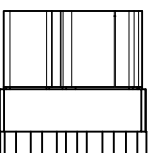
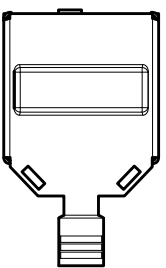
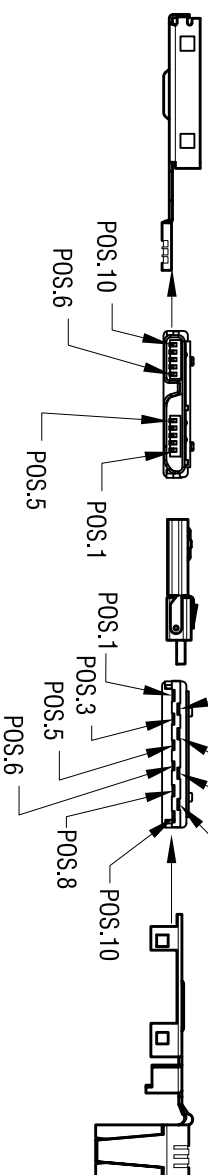
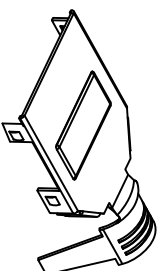

ASSEMBLED PLUG

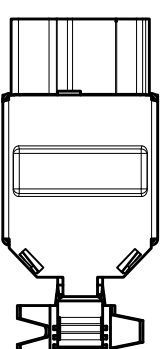
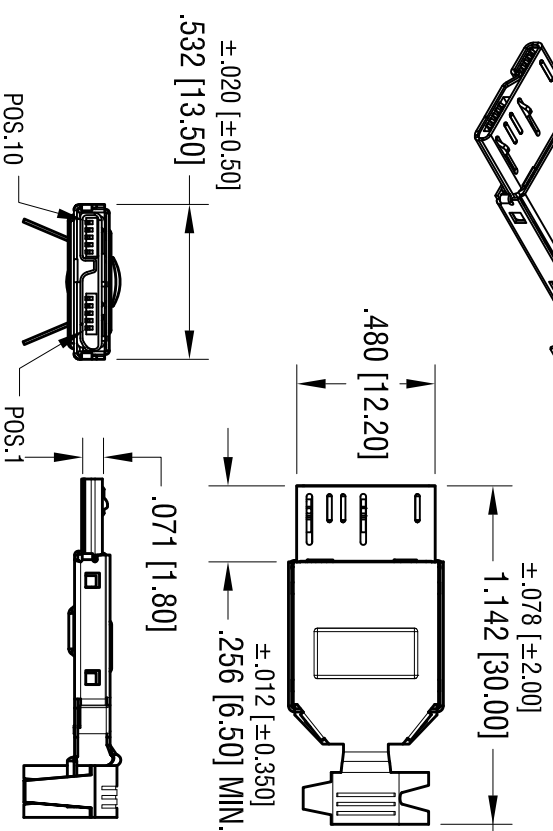
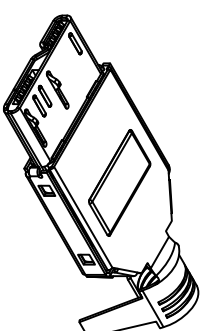

PLUG SPECIFICATIONS:

SHELL: MAT'L- STEEL

FINISH- NICKEL PLATE

CONTACT: MAT'L- PHOSPHOR BRONZE

FINISH- GOLD FLASH OVER NICKEL

INSULATION: MAT'L- THERMOPLASTIC, UL 94V-0

ELECTRICAL CHARACTERISTICS:

RATED VOLTAGE: 30V (RMS)

CONTACT CURRENT RATING: 1.8 Amp DC MAX.

CONTACT RESISTANCE: 50m Ω max.

DIELECTRIC WITHSTANDING VOLTAGE: AC 100 V.R.M.S.

MECHANICAL CHARACTERISTICS:

OPERATING TEMPERATURE: -13°F (-25°C) TO 176°F (+80°C)

DURABILITY: 1500 CYCLES MIN.

DATE	DESCRIPTION	REV.
6.01.11	CHANGE AS PER ECN 11-076	A
3.26.15	CHANGE AS PER ECN 15-040 (B1) WAS 1.008 [25.60]	B
9.01.16	CHANGE AS PER ECN 16-082 UPDATE SHELL	C

KEYSTONE ELECTRONICS CORP.
 www.keystone.com • ASTORIA, N.Y. 11105-2017 • Tel (718) 956-8900

PART NAME
USB 3.0 MICRO PLUG

MATERIAL
 AS NOTED

FINISH
 AS NOTED

TOLERANCES	INCH	[MM]	CODE	DWG NO.
DECIMAL	± .010	[± 0.25]	C	957
ANGULAR	± 1°			

THIS DOCUMENT IS THE PROPERTY OF
 KEYSTONE ELECTRONICS CORP. AND
 SHALL NOT BE REPRODUCED, DISTRIBUTED
 OR USED AS A BASIS FOR MANUFACTURE
 WITHOUT PRIOR WRITTEN PERMISSION
 FROM KEYSTONE ELECTRONICS CORP.

DRN BY	DATE
NT	8.11.10
APP'D	SCALE
LN	1.5X