

BK PRECISION®

Instruction Manual

Model 890 Capacitance Sorting Meter

Limited Three Year Warranty

B&K Precision Corp. warrants to the original purchaser that its product and the component parts thereof, will be free from defects in workmanship and materials for a period of three years from the date of purchase.

B&K Precision Corp. will, without charge, repair or replace, at its' option, defective product or component parts. Returned product must be accompanied by proof of the purchase date in the form a sales receipt.

To obtain warranty coverage in the U.S.A., this product must be registered by completing and mailing the enclosed warranty card to B&K Precision Corp., 1031 Segovia Circle, Placentia, CA 92870 within fifteen (15) days from proof of purchase.

Exclusions: This warranty does not apply in the event of misuse or abuse of the product or as a result of unauthorized alterations or repairs. It is void if the serial number is altered, defaced or removed.

B&K Precision Corp. shall not be liable for any consequential damages, including without limitation damages resulting from loss of use. Some states do not allow limitation of incidental or consequential damages, so the above limitation or exclusion may not apply to you.

This warranty gives you specific rights and you may have other rights, which vary from state-to-state.

Model Number: _____

Date Purchased: _____

TABLE OF CONTENTS

	PAGE
USING THE METER SAFELY	2
• SAFETY INFORMATION	2
CAPACITOR SORTING METER	3
• INTRODUCTION	3
LCD DISPLAY ILLUSTRATION	4
GETTING ACQUAINTED WITH YOUR DEVICE	5
• INPUT TERMINALS	5
PUSH-BUTTON OPERATIONS	6
POWER ON OPTIONS	9
SPECIAL FUNCTIONS	10
• Static Recording™	10
• Data Hold	11
• Relative (Zero)	11
• Auto Power Off	13
• Disable Auto Power Off	13
• Demonstrate Display Annunciators	13
• Tolerance (TOL) Mode	13
• Audible Alert Mode(♪)	15
• Set Mode	16
• Communication Function	17
HOW TO OPERATE	18
• COMPONENT TEST	18
GENERAL SPECIFICATIONS	19
ELECTRONIC SPECIFICATIONS	20
MAINTENANCE	21
• SERVICE	21
• BATTERY REPLACEMENT	21
• CLEANING	22

WARNING

Read "SAFETY INFORMATION" before using this device.

NOTE

When measuring in-circuit components, firsts de-energize the circuit before connecting to the test leads. The warnings and precautions should be read and well understood before the instrument is used. All warnings and precautions during use should be observed. It is recommended this instrument should be used by a suitably trained and competent person.



A **WARNING** (Warning symbol) identifies conditions and actions that may cause hazard(s) to the user; a **CAUTION** identifies conditions and actions that may damage this Device.

SAFETY INFORMATION

To ensure that you use this meter safely, follow the safety guidelines listed below:

- Read this operation manual completely before using this device and follow all safety instructions.
- This device is for indoor use, altitude up to 2,000 m(6561 ft).
- Use the device only as specified in this manual; otherwise, the protection provided by the meter may be impaired.
- Never measure Voltage with this meter.
- Do not use this device if it looks damaged.
- Disconnect the power and discharge all high-voltage capacitors before testing.
- CE requirement: Under the influence of RF field according to standard, the supplied test leads will pick up induced noise. To have better shielding effect, a short-twisted lead should be used. The standard of test requirement shows below.
 1. IEC 801-2: That is ESD (electro-static discharge) test.
 2. IEC 801-3: This is RFI (Radio Frequency Interference) test.
Condition: 27~500MHz, signal intensity is 3Volts per meter.
 3. IEC 801-4: This is EFT (electrical fast transient) test.
 4. EN 55011: This is EMI test.

INTRODUCTION

This meter is uniquely designed for capacitor sorting. It is a fully autoranging 5000 count meter. Manual ranging can be selected via the front push button.

MAIN FEATURES:

- Auto-range, 5000 count resolution and large LCD with dual display.
- Wide range measuring: 0.1pF to 50 mF.
- Visible and audible Tolerance mode assist you to sort the capacitor.
- Ten memories for High / Low Limit setting, included non-volatile memory inside, will keep your setting even the power off.
- Static Recording, you will know maximum, average and minimum values without calculator.
- Relative mode will help you measure the difference between a standard and a measuring values.
- Computer interface will assist you to a specialist and make report easier.

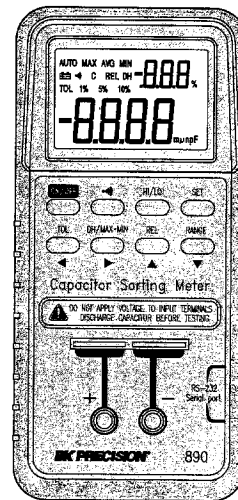

LCD DISPLAY ILLUSTRATION

- 1) **AUTO** : AUTO range Mode
- 2) **TOL** : Tolerance mode annunciator
(TOL 1% 5% 10%)
- 3) **-00000** : Primary display.
- 4) **o))** : Audible alert annunciator
- 5) **DH** : Data hold or Refresh hold annunciator
- 6) **⊖** : Low battery indication.
- 7) **REL** : Relative(Delta) mode annunciator
- 8) **mμpF** : Units for capacitance measurement
- 9) **MAX AVG MIN** : Static recording mode, indicates the present reading
- 10) **MAX** : Maximum reading
- 11) **AVG** : Average reading
- 12) **MIN** : Minimum reading
- 13) **C** : Communication ON annunciator
- 14) **-0000** : Secondary display.
- 15) **7060** : Means the reading out off the HI/LO limits
- 16) **7060** : Means the reading in the HI/LO limits
- 17) **|||||** : The primary display shows HI limit setting
- 18) **|||||** : The primary display shows LO limit setting
- 19) **|||||** : Means ready state for audible alert mode.
- 20) **%** : Unit for tolerance display.

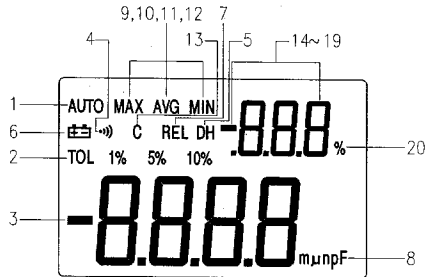

Figure 2. LCD Display

Getting Acquainted With Your Meter

□ INPUT TERMINALS

WARNING

To avoid damaging this meter, do not exceed the input limit. Do not apply voltage to input terminals. Discharge the capacitor before testing.

- 1) Positive terminal
- 2) Negative terminal

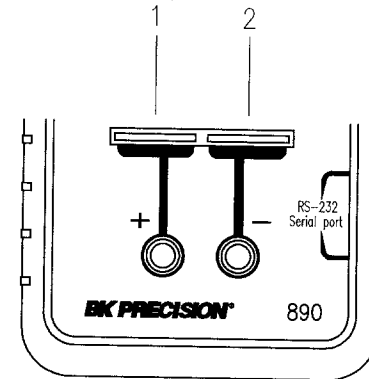

Figure 3. Input Terminals

DISTRIBUTION OPERATIONS

The operation of push-buttons is described below. When a button is pressed, a display symbol will light, and the beeper will sound.

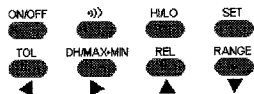

Figure 4. Input Buttons.

1. ON / OFF:

Power ON or OFF

- This button is used to toggle the power ON or OFF for the meter. Be sure to press button completely to lock or release this switch.

2. DH:

DATA HOLD

- The data hold function allows operator to hold the displayed digital value. Press this button momentarily to toggle DH on or off.

3. DH (MAX • MIN):

Static Recording

- Record maximum, minimum, and calculates average. Press this button for more than 1 second to toggle recording mode on or off.
- Press this button momentarily to cycle through MAX, MIN, AVG and present (MAX AVG MIN) readings.
- The beeper sounds when a new value is updated.
- Static recording captures only stable values and updates the memory; it will not record any "OL" (overload) and below 10 count values..

4. REL

Relative function

- The relative function shows the difference between the measured value and the stored value. Press this button momentarily to toggle Relative ON or OFF.

5. RANGE:

Auto/ Manual Range

- In auto-range, press this button to select manual range and turn off the "AUTO" annunciator.
- In manual range, press this button momentarily to step up a range at a time. Press this button for more than 1 second to select auto-range.
- In auto-range, the "AUTO" annunciator is lit and the meter will select an appropriate range for resolution if a reading is greater than maximum available range, "OL" (overload) will be displayed on the display. The meter will select a lower range when reading is less than about 9% of full scale.

6. TOL:

Tolerance mode

- With capacitor in place, press the button momentarily to enter the tolerance mode. The "TOL" annunciator will be indicated. The secondary display will indicate the tolerance. The 890 range locks in this mode.
- Press this button momentarily again to cycle through 1%, 5% and 10% tolerance as desire. The "•••)" annunciator will show as well as the relative annunciator for 1%, 5% and 10 %.
- The beeper sounds a tone while the test value is under selected tolerance. If the test value out off the tolerance, the beeper will sound three tones.
- Press and hold this button for more than 1 second to exit tolerance mode.
- The tolerance mode cannot be activated if the tested display is either "OL" or below 10 count.

7. •••):

Audible Alert

- Press this button momentarily to enter HI/LO Audible Alert mode. The 890 range locks in this mode. The "•••)" annunciator will show, and the secondary display will indicate "C # #" to "C # #". The first left digit means comparison mode. The last two digits indicate current comparison set. The "# #" is from 01 to 10. The primary display will indicate the present measurement. In this state, it is ready for testing. If the reading is outside the high and low limits, the beeper sound three tones, also the secondary display indicates "nGo". If the reading is inside the high and low limits, the beeper sounds a tone, and the secondary display indicates "Go". After 3 seconds or the reading lower than 10 counts, the 890 will return to ready state.
- In the Audible Alert mode, press this button momentarily to select different settings from the memory. The secondary display will indicate "C01" to "C10" according to which comparison record has been selected.
- Press and hold this button for more than 1 second to exit audible alert mode.

8. HI/LO:

High/Low

- In the Audible Alert mode, press this button momentarily to cycle through High limit, Low limit and present values. The secondary display showed as "H # #", "L # #" and "C # #" respectively. After 3 seconds without pressing this button again, it will return present value display.
- In the set mode, press this button momentarily to toggle the setting for HI and LO limits. Press the HI/LO button for more than one second to record the setting in to the memory.

9. SET:

SET Mode

- Press and hold this button for more than 1 second to enter the HI/LO limit setting mode. The secondary display will flash "H01" and the primary display will indicate the value of High limit.
- In the set mode, press this button momentarily to select next pair of setting value. Press this button momentarily to cycle through H02, H03,.....H09, H10 then come back to H01 set. Press the HI/LO button for more than one second to record the setting into the memory. The beeper will sound one tone, it means the selected value has been recorded. If the current setting can not meet the rule that the high limit must equal or greater than the low limit, the beeper sounds three tones. Press HI/LO button momentarily to toggle the setting mode among HI and LO limits. The buttons of up, down, left and right (▲, ▼, ◀ and ▶) are used to adjust the setting.
- Press and hold this button for more than 1 second to exit the HI/LO limit setting mode.

9.1 ◀ (LEFT):

Moves to the left digit for selection of value in set mode.

9.2 ▶ (RIGHT):

Moves to the right digit for selection of value in set mode.

9.3 ▲ (UP):

Increase digit value

9.4 ▼ (DOWN):

Decrease digit value

POWER-ON OPTIONS

■ SELECTING POWER-ON OPTIONS

Some options can be selected only when you turn the meter on. These power-on options are listed in Table 1. To select power-on options, press and hold the push button while pushing the ON/OFF switch to on position. Power-on options remain selected until the meter is turned off.

PUSHBUTTON	OPTION DESCRIPTION
DH	Demonstrate Annunciators To demonstrate the annunciators, the entire annunciators will be displayed. Press the button again to exit demonstration mode.
SET	To replace the high and low limits to manufacture's preset values.
→))	Disable beeper function. Turns off all beeper functions.
RANGE	Disable auto-power off In general, the auto power off function will turn the meter off if no push button is activated for 15 minutes. When auto power off is disabled, the meter will stay on continuously
TOL	Set Computer Interface. Turn on Data output function via RS-232C interface. The "C" annunciator will be lit.
REL	Calibration mode. The primary display will show "CSEE". Do not perform calibration unless you are qualified to do so.

Table 1. Power-ON Options

SPECIAL FUNCTIONS

This meter provides operators with various functions including:

- Static Recording**
- Data Hold**
- Relative**
- Auto Power Off**
- Disable Auto Power Off**
- Demonstrate Display Annunciator**
- Tolerance mode**
- Audible Alert Mode()**
- Set Mode**
- Communication Function**

Static Recording™

The operational procedures are described below:

- 1) Press "**MAX • MIN**" for more than 1 second to enter the static recording. The present value is stored to memories of maximum, minimum and average, also the **MAX AVG MIN** annunciator will be lit. Whenever the "**MAX AVG MIN**" indicators appear on the LCD simultaneously, the display reading is always a present value.
- 2) Press this button for more than 1 second to exit recording mode.
- 3) Press this button momentarily to cycle through maximum, minimum, average and present readings. The **MAX**, **MIN**, **AVG** or **MAX AVG MIN** annunciator turns on respectively to indicate which value is being displayed. See **Figure 5**.
- 4) The beeper sounds a tone when a new max or min value has been recorded.

Notes:

- Static recording captures only stable values and updates the memory; it will not record any "OL" (overload) value. In addition, the meter will not record values which are below 10 counts.

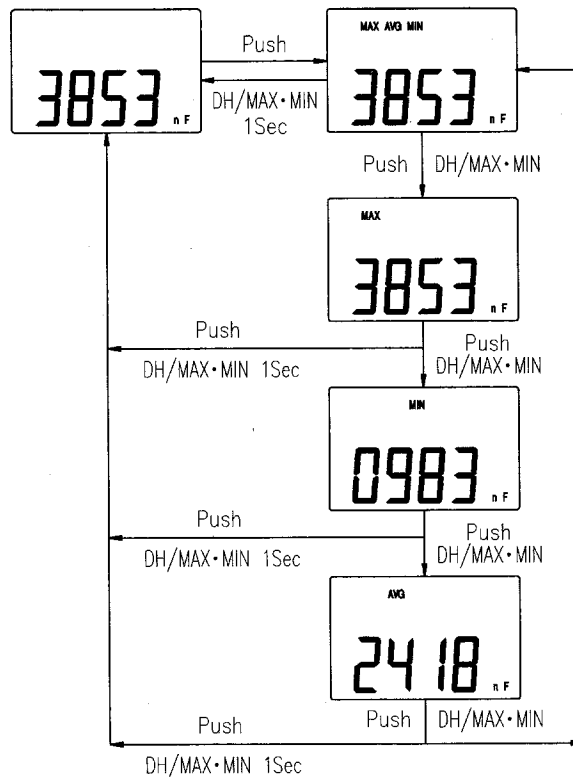

Figure 5. Display of Static Recording

□ DATA HOLD

The data hold function allows operator to freeze the displayed value. Press **DH** button to enter the data hold mode, and the "DH" will be displayed. Press the button again to exit.

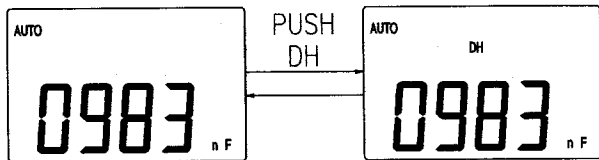

Figure 6. Data Hold Operation.

□ RELATIVE (ZERO)

The relative function subtracts a stored value from the present measurement and displays the result.

- 1) Press **REL** button momentarily to set the relative mode. This sets the display to zero and stores the displayed reading as a reference value, also "REL" will be displayed.
- 2) Rel operates in both auto or manual ranging mode. The relative mode can't be set when an overload exists.
- 3) Press this button again to exit the relative mode.
- 4) The display may read a non zero value due to the presence of test leads. You can use the relative function to Zero the display.

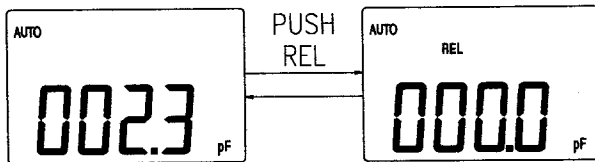

Figure 7. Relative(Zero) Operation.

□ AUTO POWER OFF

The instrument may enter auto power-off mode within 15 minutes, if none of the following happens.

1. Push buttons are depressed.
2. Disable auto power off with power-up option.
3. Static Recording is engaged.

To wake-up from the auto power off mode, you must push the switch to the OFF, then turn on the meter again by pressing power ON/OFF switch.

□ DISABLE AUTO POWER OFF

When the meter is to be used for long periods of time, the operator may want to disable the auto power off. Once the auto power off function is disabled, the meter will stay on continuously. To shut off the meter press ON/OFF switch to the off position.

To activate this function, press the **RANGE** button and turn on the meter simultaneously.

□ DEMONSTRATE DISPLAY ANNUNCIATORS

To demonstrate the annunciators, press the **DH** button and turn on the meter simultaneously. All annunciators will be displayed. Press any button to exit demonstration mode.

1. Push and Hold



2. Turn on the meter.

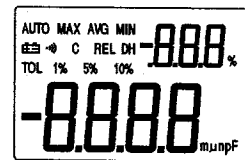

Figure 8. Demonstrate Annunciator.

□ Tolerance Mode

There are 1%, 5% and 10% tolerance ranges. To enter the tolerance mode, insert a standard value into the socket. Press the "TOL" pushbutton to set this value as the standard reference. Similarly, the DH value which appears on the LCD display, can be used as a standard value to sort components. Press the key again to cycle through 1%, 5% and 10% tolerance as desired. The 890

range locks in the "TOL" mode. This mode can not be set under following condition:

- After setting the recording mode.
- After setting HI/LO Audible Alert mode.
- The tested display is either "OL" or below 10 count.

This function is designed for sorting. An audible tone will beep three times when a component is out of the set tolerance. A single "beep" tone indicates the component is within the selected tolerance.

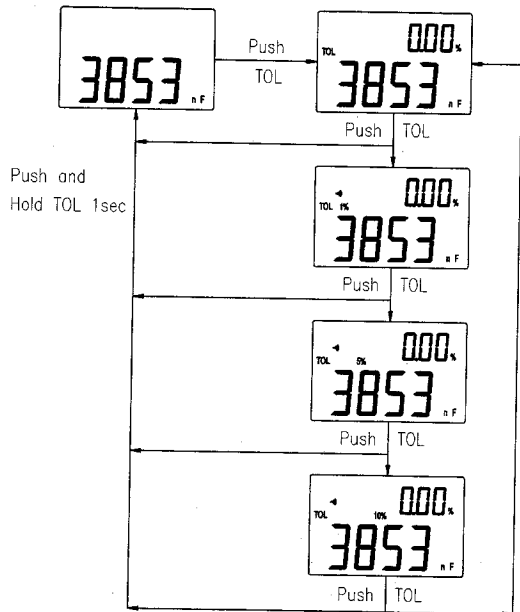

Figure 9. Tolerance Operation.

☐ AUDIBLE ALERT MODE(☺☺)

This function will help you sort capacitors, and you can set 10 pairs of limit ranges. This meter has initial set for High and Low limits, see below table:

SET	1	2	3	4	5	6	7	8	9	10
High	0033	0047	0100	0220	0330	0470	1000	2200	3300	4700
Low	0029	0043	0090	0198	0297	0423	0900	1980	2970	4230

You can change these sets, please refer to the SET MODE for detailed description. Also you can use the power-on option to restore factory tolerance.

- Press this button momentarily to enter HI/LO Audible Alert mode. The 890 range locks in this mode. The "☺☺" annunciator will show, and the secondary display will indicate "C ##" to "C ##". The first left digit means comparison mode. The last two digits indicate current comparison set. The "##" is from 01 to 10. The primary display will indicate the present measurement. In this state, it is ready to test. If the reading is outside the high and low limits, the beeper will sound three tones, also the secondary display indicates "nGo". If the reading is inside the high and low limits, the beeper sounds a tone, and the secondary display indicates "Go". After 3 seconds or the reading is lower than 10 counts, the 890 will return to ready state.
- Press this button momentarily to select different set on the memory. The secondary display will indicate "C01" to "C10" according to which comparison set has been selected.
- Press and hold the "☺☺" button for more than 1 second to exit audible alert mode.

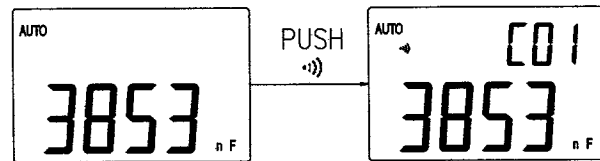

Figure 10. AUDIBLE ALERT MODE(☺☺).

□ Set Mode

Using this mode to set the HIGH and LOW limits, see the following procedures:

- Press and hold the "SET" button for more than 1 second to enter the HI/LO limit setting mode. The secondary display will be flashing "H01" and the primary display will indicate the value of High limit.
- You can press the SET button momentarily to select which pair will be set. Press this button to cycle through H02, H03,.....H09, H10 then come back to H01 set.
- To use the buttons of up, down, left and right (▲, ▼, ◀ and ▶) to adjust the setting. To see these buttons for detail.
- After the setting, press the "HI/LO" button for more than one second to record the setting into the memory. The beeper will sound one tone, it means the setting value has been recorded. If the current setting can not meet the rule that the high limit must equal or greater than the low limit, the beeper sounds three tones("BE-BE-BE"). Press HI/LO button momentarily to toggle the setting mode among HI and LO limits.
- Press and hold the "SET" button for more than 1 second to exit the HI/LO limit setting mode.

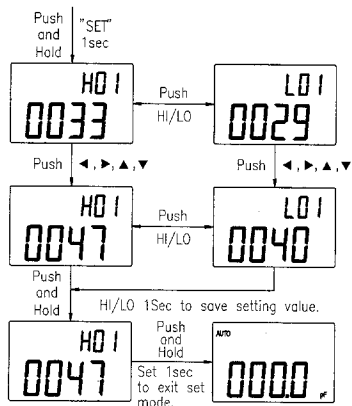

Figure 11. SET MODE.

□ Communication Function

This device has a RS232 communication option. This function will assist the user to record and document data.

Please refer to the following procedure if you want to communicate with a personal computer.

1. Push and hold the TOL button then push the POWER ON/OFF switch to ON position, wait around 1 second, then release the push button. You will find that the "C" sign lit on the display.
2. Connect one side of cable to the RS232 jack of meter and connect the 9 pin cable terminal to communication port 1 or 2 of the personal computer. See Figure 12.
3. Execute the software.

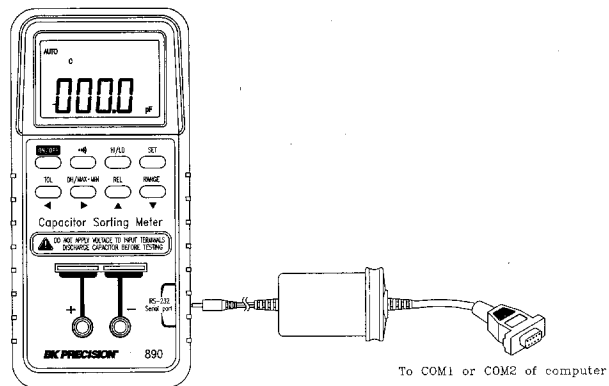

Figure 12. Cable Connection for Communication

□ CAPACITANCE MEASUREMENT

- 1) Turn on the meter.
- 2) Connect the red lead to "+ " terminal, and black lead in "-" terminal.
- 3) Open the test probes, then push "REL" button momentarily to zero the residual.
- 4) Connect the test lead across the capacitor and read the display.

CAUTION: 1. Observe polarity when measuring polarized capacitors.
2. Discharge capacitor before measurement.

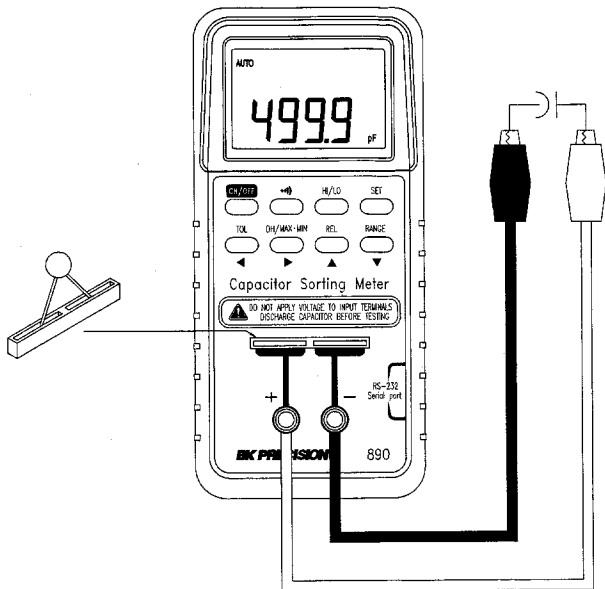

Figure 13. Capacitance Measurement.

Display:

- Dual display, primary display is 4 digits with maximum reading of 5,000. Second display is 3 digits for tolerance display.
- Automatic polarity indication for relative function.

Function:

- Full auto-range capacitance measuring, from 0.1pF to 50mF.

Measuring rate:

- 4 times per second for ranges 500pF to 5000nF.
- 1 times per second for ranges 50 μF to 5000 μF.
- 0.1 times per second for range 50mF.

Low battery indicator:

⊠ at 7.0 ± 0.7V (approx).

Operating temperature:

0°C to 50°C (32°F to 122°F), 0 - 80 % R.H.

Storage temperature:

-20°C to 60°C (-4°F to 140°F), 0 - 80 % R.H. with BATTERY REMOVED.

Temperature coefficient

0.15 x (specified accuracy) / °C [from 0°C to 18°C (0°F to 64°F) or 28°C to 50°C (82.4°F to 122°F)]

Power supply:

Single standard NEDA1604, JIS006P, IEC6F22 carbon-zinc or alkaline type 9V battery.

Dimension:

37 (H) * 90 (W) * 192 (L) mm.(1.46" * 3.54" * 7.56")

Weight:

500 grams(17.637 oz) with standard accessories.

Standard Accessories:

Test leads (a pair), Manual, 9V Battery

Accessories:

RS232C package.
Protective Holster: Included.
RS232 package: Optional.

TECHNICAL SPECIFICATIONS

Accuracy is given as \pm (% of reading + no. of least significant digits) at 23°C \pm 5°C, with relative humidity Less than 80% R.H.

□ CAPACITANCE

Range	Resolution	Accuracy ^{†1}	Overload Protection
500.0pF	0.1 pF	$\pm(1\%rdg+10dgt)$	50V DC/ 30 V AC
5 nF	1 pF		
50 nF	10 pF		
500 nF	0.1 nF		
5 μ F	1 nF		
50 μ F	10 nF	$\pm(2\%rdg+3dgt)$	
500 μ F	0.1 μ F		
5000 μ F	1 μ F		
50mF	10 μ F		
		>2mF, NO Spec.	

Note1: With film capacitor or better, and use Relative mode to zero residual.

MAINTENANCE

WARNING

To avoid electrical shock, do not perform any service unless you are qualified to do so.

□ SERVICE

If the instrument fails to operate, check battery, test leads, etc. and replace them if necessary. If the instrument still does not work, double check operating procedure as described in this instruction manual. When servicing, use specified replacement parts only.

WARNING

To avoid electrical shock or damage to the meter, do not get water inside the case. Remove the test leads and any input signals before opening the case.

□ BATTERY REPLACEMENT

The meter is powered by a single 9V battery, with NEDA1604, JIS006P, IEC6F22 carbon-zinc or alkaline battery. Replace battery if the low battery sign () is displayed and flashes. Use the following procedure to replace the battery:

1. Turn the meter off and disconnect the test leads.
2. Loosen 3 screws on bottom cover, pull up and move the cover.
See **Figure 14**.
3. Replace the defective battery.
4. Reverse the procedure of opening cover to close the bottom cover.

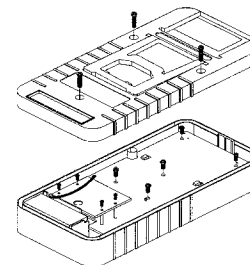

Figure 14. Battery Replacement.

☐ CLEANING

To clean the instrument, use a soft cloth dampened in a solution of mild detergent and water. Do not spray cleaner directly onto the instrument, since it may leak into the cabinet and cause damage.

Do not use chemicals containing benzine, benzene, toluene, xylene, acetone or similar solvents.

Service Information

Warranty Service: Please return the product in the original packaging with proof of purchase to the below address. Clearly state in writing the performance problem and return any leads, connectors and accessories that you are using with the device.

Non-Warranty Service: Please return the product in the original packaging to the below address. Clearly state in writing the performance problem and return any leads, connectors and accessories that you are using with the device. Customers not on open account must include payment in the form of a money order or credit card. For the most current repair charges contact the factory before shipping the product.

Return all merchandise to B&K Precision Corp. with pre-paid shipping. The flat-rate repair charge includes return shipping to locations in North America. For overnight shipments and non-North America shipping fees contact B&K Precision Corp..

B&K Precision Corp.
1031 Segovia Circle
Placentia, CA 92870
Phone: 714-237-9220
Facsimile: 714-237-9214

Include with the instrument your complete return shipping address, contact name, phone number and description of problem.