

Features

- Very Low Forward Voltage Drop
- Guard Ring Construction for Transient Protection
- High Conductance
- **Lead, Halogen and Antimony Free, RoHS Compliant "Green" Device (Notes 2, 4 and 5)**

Mechanical Data

- Case: SOD-323
- Case Material: Molded Plastic. "Green" Molding Compound. UL Flammability Classification Rating 94V-0
- Moisture Sensitivity: Level 1 per J-STD-020D
- Terminal Connections: Cathode Band
- Terminals: Finish – Matte Tin Annealed Over Alloy 42 Leadframe. Solderable per MIL-STD-202, Method 208
- Marking Information: See Page 2
- Ordering Information: See Page 2
- Weight: 0.004 grams (approximate)



Top View

Maximum Ratings @ $T_A = 25^\circ\text{C}$ unless otherwise specified

Single phase, half wave, 60Hz, resistive or inductive load.
For capacitance load, derate current by 20%.

Characteristic	Symbol	Value	Unit
Peak Repetitive Reverse Voltage	V_{RRM}	30	V
Working Peak Reverse Voltage	V_{RWM}		
DC Blocking Voltage	V_R		
RMS Reverse Voltage	$V_{R(RMS)}$	21	V
Average Rectified Output Current	I_O	1	A
Non-Repetitive Peak Forward Surge Current 8.3ms Single Half Sine-Wave Superimposed on Rated Load	I_{FSM}	9	A

Thermal Characteristics

Characteristic	Symbol	Value	Unit
Power Dissipation (Note 1)	P_D	200	mW
Typical Thermal Resistance Junction to Ambient (Note 1)	$R_{\theta JA}$	426	$^\circ\text{C}/\text{W}$
Operating and Storage Temperature Range	T_J, T_{STG}	-65 to +125	$^\circ\text{C}$

Electrical Characteristics @ $T_A = 25^\circ\text{C}$ unless otherwise specified

Characteristic	Symbol	Min	Typ	Max	Unit	Test Conditions
Reverse Breakdown Voltage (Note 3)	$V_{(BR)R}$	30	—	—	V	$I_R = 500\mu\text{A}$
Forward Voltage Drop	V_F	—	—	360 485	mV	$I_F = 100\text{mA}$ $I_F = 1\text{A}$
Leakage Current (Note 3)	I_R	—	—	100	μA	$V_R = 20\text{V}$
Total Capacitance	C_T	—	22	—	pF	$f = 1\text{MHz}, V_R = 10\text{VDC}$

- Notes:
1. Part mounted on FR-4 PC board with recommended pad layout, which can be found on our website at <http://www.diodes.com/datasheets/ap02001.pdf>.
 2. Diodes Inc's "Green" policy can be found on our website at http://www.diodes.com/products/lead_free/index.php.
 3. Short duration pulse test used to minimize self-heating effect.
 4. No purposefully added lead. Halogen and Antimony Free.
 5. Product manufactured with Green Molding Compound and does not contain Halogens or Sb_2O_3 Fire Retardants.

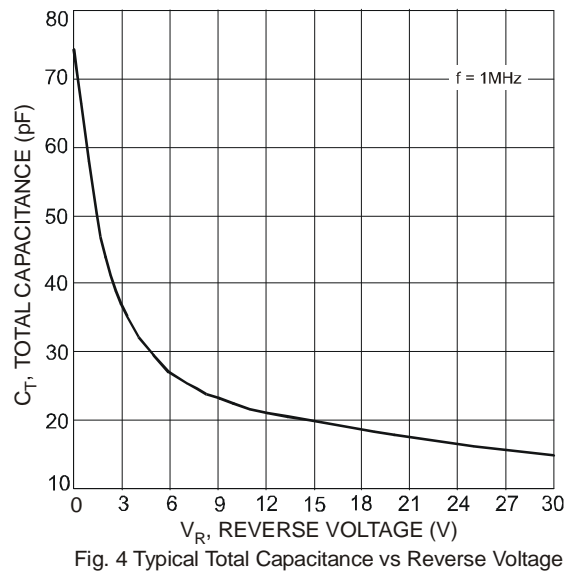
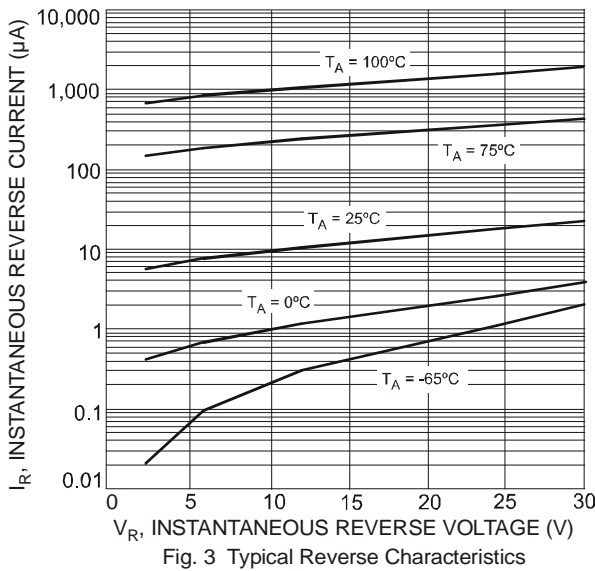
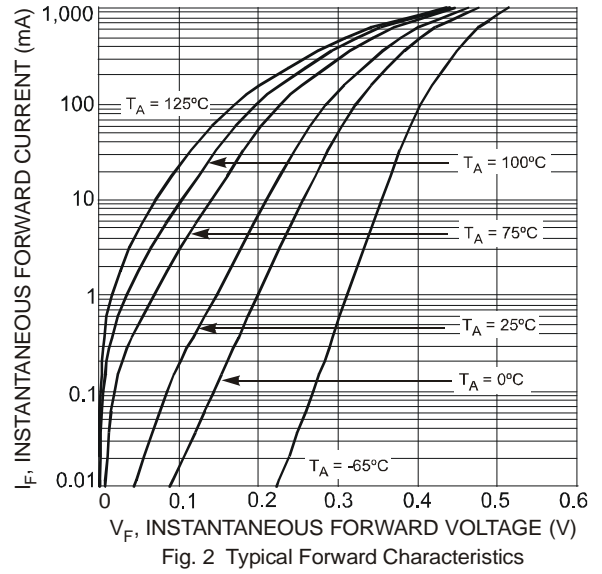
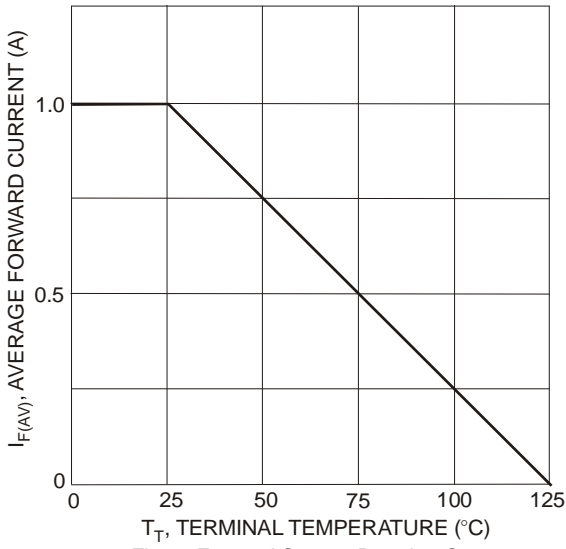

Ordering Information (Note 6)

Part Number	Case	Packaging
SDM100K30L-7	SOD-323	3000/Tape & Reel

Notes: 6. For packaging details, go to our website at <http://www.diodes.com/datasheets/ap02007.pdf>.

Marking Information

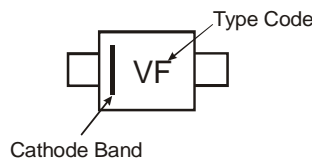

Package Outline Dimensions

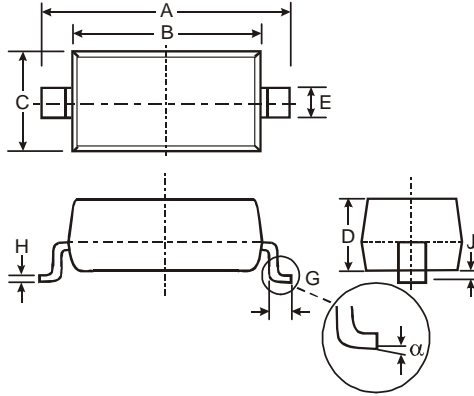

SOD-323		
Dim	Min	Max
A	2.30	2.70
B	1.60	1.80
C	1.20	1.40
D	1.05 Typical	
E	0.25	0.35
G	0.20	0.40
H	0.10	0.15
J	0.00	0.10
α	0°	8°
All Dimensions in mm		

Suggested Pad Layout

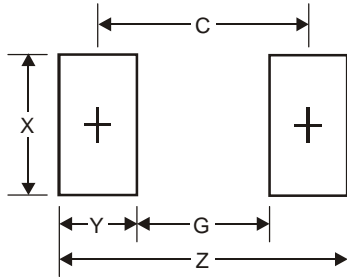

Dimensions	Value (in mm)
Z	3.75
G	1.05
X	0.65
Y	1.35
C	2.40

IMPORTANT NOTICE

Diodes Incorporated and its subsidiaries reserve the right to make modifications, enhancements, improvements, corrections or other changes without further notice to any product herein. Diodes Incorporated does not assume any liability arising out of the application or use of any product described herein; neither does it convey any license under its patent rights, nor the rights of others. The user of products in such applications shall assume all risks of such use and will agree to hold Diodes Incorporated and all the companies whose products are represented on our website, harmless against all damages.

LIFE SUPPORT

Diodes Incorporated products are not authorized for use as critical components in life support devices or systems without the expressed written approval of the President of Diodes Incorporated.