

FEATURES

- PROVIDES FAST AND EASY PERFORMANCE TESTING FOR ADS1251
- PC SERIAL PORT CONTROL
- WINDOWS® 95/98 SOFTWARE

Windows is a registered trademark of Microsoft Corp.

DESCRIPTION

The ADS1251EVM demo board is designed for ease of use when evaluating the high-resolution analog-to-digital converter ADS1251. The ADS1251 offers 24-bits No Missing Codes performance. It has one differential input channel.

The ADS1251 features a synchronous serial interface. It has been designed for closed-loop control applications in the industrial process market and high-resolution applications in the test and measurement market. It is also ideal for remote applications, battery-powered instruments, and isolated systems.

Note: The ADS1251 and ADS1252 will both work in the ADS1252EVM. The ADS1251EVM uses the same board as the ADS1252EVM.



Please be aware that an important notice concerning availability, standard warranty, and use in critical applications of Texas Instruments semiconductor products and disclaimers thereto appears at the end of this data sheet.

INITIAL CONFIGURATION

The ADS1251EVM is designed to be operational without any user configuration except for connecting power supplies and the communications cable to the PC serial port. Jumpers JMP1 (Clock Oscillator), JMP3 (DUT clock), JMP8 (ADS1251 power), and JMP10 (reference select) have already been installed.

POWER SUPPLY

The demo board is powered from an 8V to 12V power source. That voltage is regulated to 5V for use of the ADS1251 and the microprocessor.

VOLTAGE REFERENCE

Jumper JMP10 is used to select the source for the reference voltage. If the jumper is placed on the two pins closest to the BNC connector, the BNC connector will be selected as the source of the reference voltage. If the jumper is placed on the two pins away from the connector, then the on-board 4.096V reference is chosen. The selected voltage is buffered with an OPA350 op amp for the use of the ADS1251.

CLOCK

The 50MHz crystal oscillator provides the operating frequency for the microprocessor. The processor in combination with a PLL provides a clock for the ADS1251.

PC BOARD LAYOUT

The ADS1251EVM demo board consists of a four-layer PC board. To achieve the highest level of performance, surface-mount components are used wherever possible. This reduces the trace length and minimizes the effects of parasitic capacitance and inductance. The demo board has a split ground plane with all the analog signals over one portion and the digital signals in the other. Keep in mind that this approach may not necessarily yield optimum performance results when designing the ADS1251 into different individual applications. In any case, thoroughly bypassing the power supply and reference pins of the converter is strongly recommended.

WINDOWS SOFTWARE

The serial port used for communications can be specified on the command line. Just add “port1”, “port2”, etc. after the command in the Target field, as shown in Figure 1. It can also be specified in the program.

The ADS1251 is very easy to use. Basically, supply a clock and read the output data. The Evaluation software provides a convenient method to vary the operation and observe the results. It also can display the results of acquired data and perform a frequency analysis.

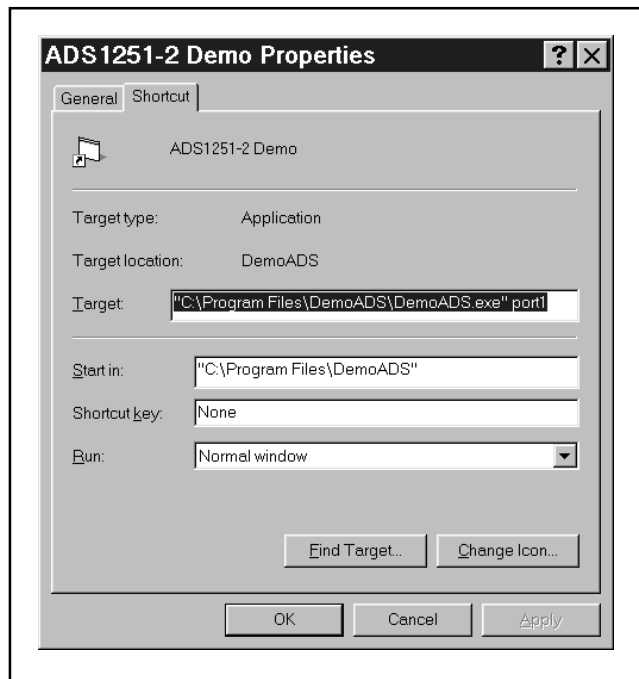

FIGURE 1. Demo Properties.

The program has two windows: 1) The Control Window and 2) The Data Display Window. The Control Window can Acquire data, set the frequency for data acquisition and select the PC communications port.

In the Get Data screen, shown in Figure 2, the number of samples can be set from 32 to 32768 points. Each data point can be raw data from the ADS1251 or the points can be the result of averages of the Analog-to-Digital (A/D) converter data. Up to 32,768 averages can be performed for each output data point.

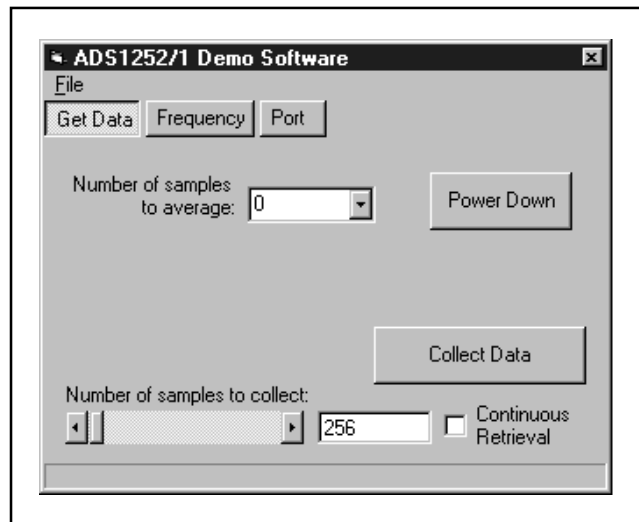

FIGURE 2. Initial Control Window.

The **Power Down** button will put the part into a low-power state. **Collect Data** will return the part to the full-power state. The power-down state will only reduce the demo board current by about 1mA. For detailed power analysis, use JMP8 to power the part from an external source.

The Frequency screen, shown in Figure 3, lets you choose the operating frequency of the device. The frequencies of 2kHz and 10kHz give good noise performance. Although, by selecting Variable Sample Rate, other sample rates can be selected by choosing the output sample rate or the clock frequency (Sample Rate • 384). The maximum recommended frequency for the ADS1251 is 8MHz or a sample rate of 20.8kHz. The noise is not as good when using the Variable Sample Rate because of the PLL used to generate the clocks.

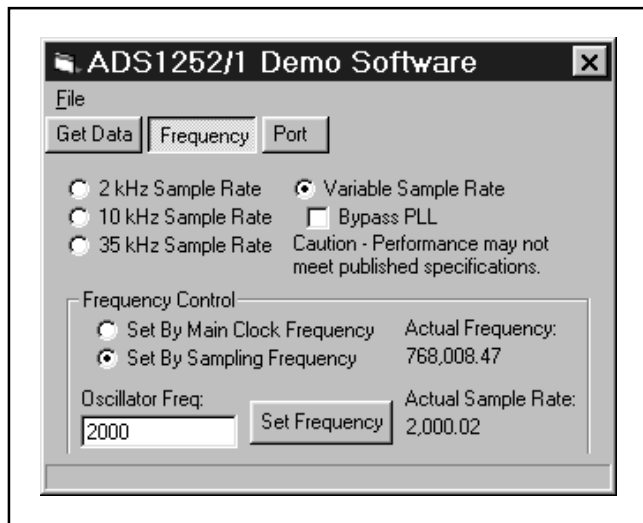

FIGURE 3. Frequency Screen.

The Options screen, shown in Figure 4, gives you control of which serial port the program will use when it communicates with the evaluation module. This is also where you specify the reference voltage used to normalize the data for a “scaled by LSB” voltage display.

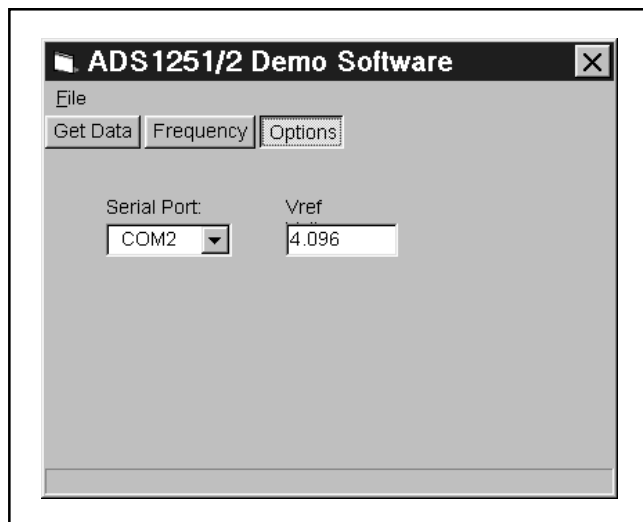

FIGURE 4. Configuration Window.

Along the top of the Time Domain Display, shown in Figure 5, are icons that can be used to select the various display modes. The four displays are 1) Time Domain, 2) FFT, 3) Histogram and 4) Data List. Statistics for the data are also displayed on the top of the Time Domain Display. It shows the Standard Deviation, Mean, Maximum, and Minimum.

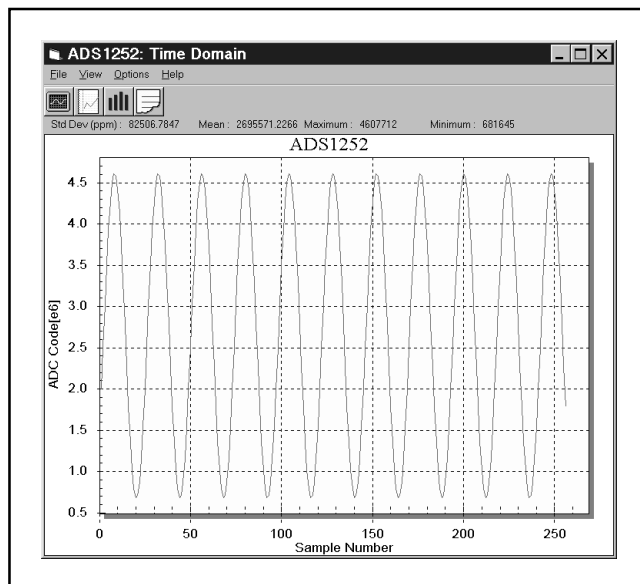

FIGURE 5. Time Domain Display.

Several figures of merit are computed from the FFT information shown in Figure 6. These include the Signal to Noise Ratio (SNR), Signal to Noise plus Distortion (SINAD), Total Harmonic Distortion (THD) and Spurious Free Dynamic Range (SFDR).

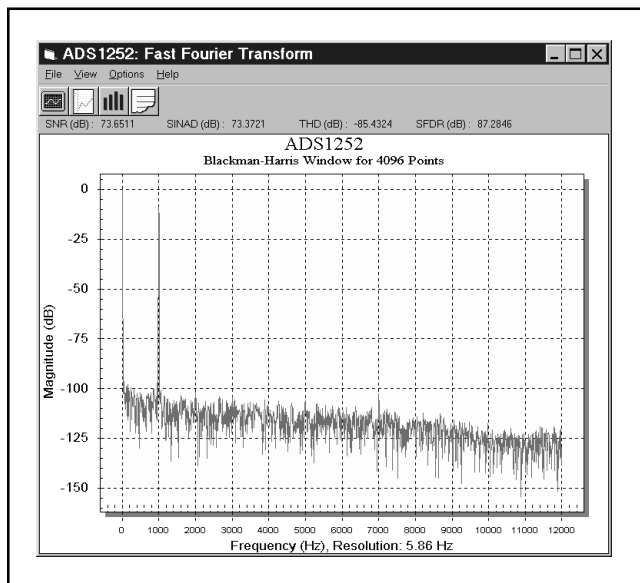

FIGURE 6. FFT Display.

There are many options for the FFT display. The options menu selection opens the screen shown in Figure 7.

Several windows are provided to modify the data before the FFT computation. Additionally, the FFT display can mark some features such as the main frequency and the harmonics.

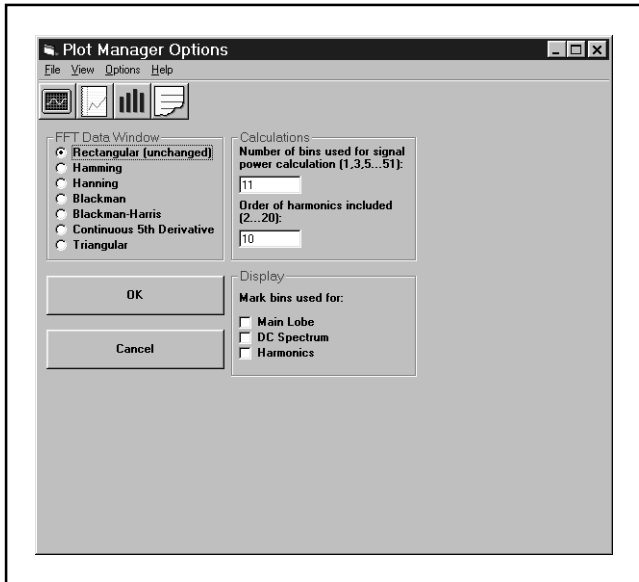

FIGURE 7. FFT Options.

Finally, the data can be analyzed in detail with the Data List display shown in Figure 8.

The Data Formats can be selected. This selection will also be used for the display of the date in the Time Domain display. The “Scaled by LSB” converts the data to a voltage with the assumption that the voltage reference is as defined in Figure 4.

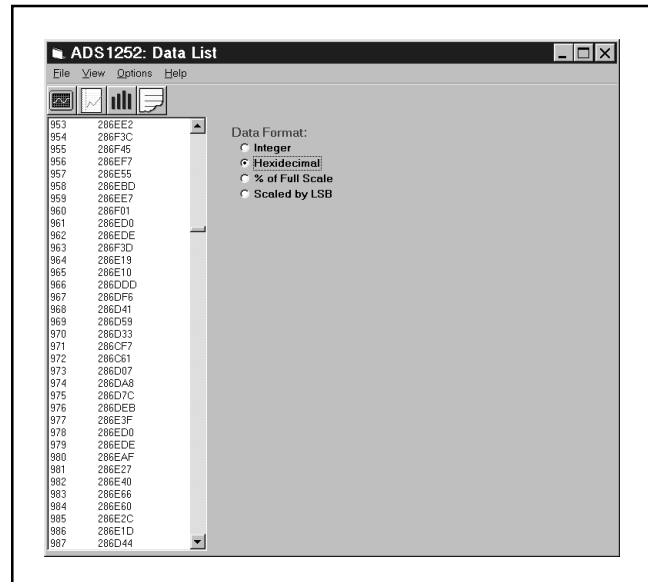

FIGURE 8. Data List Display.

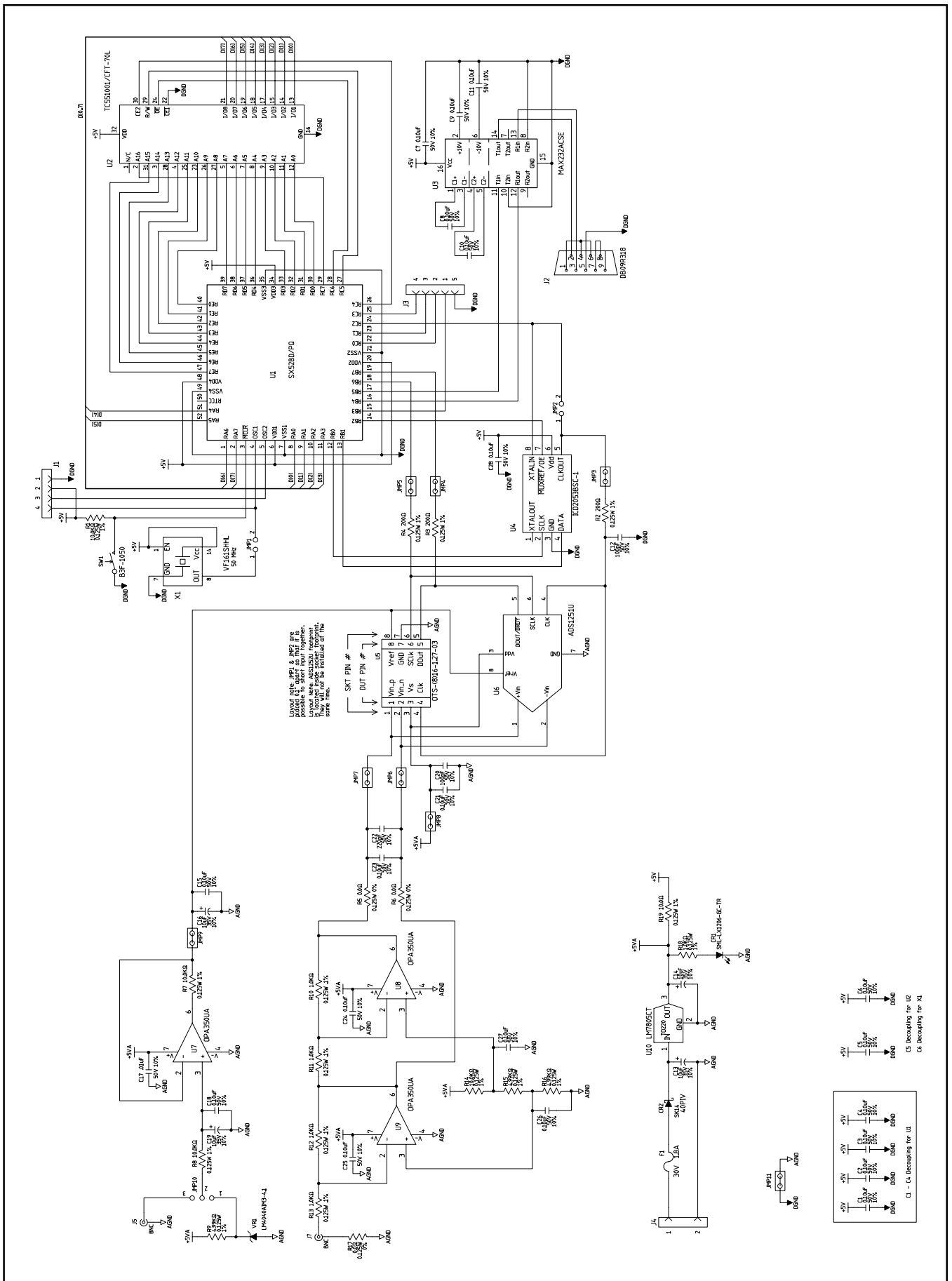

FIGURE 9. Schematic

COMPONENT LIST

PART NUMBER	DESCRIPTION	REF. DES.	QTY	VENDOR PART NUMBER	MANUFACTURER
ADS1251U	IC, A/D CONV, 24-BIT,20kHz	U6	1	ADS1251U	
B3F-1050	SWITCH, SPST, PB-MOM	SW1	1	B3F-1050	
CRCW120610R0F	RES, 10.0Ω, 0.125W, 1%, CHIP-THICK-FILM	R ₁₉	1	CRCW120610R0F	DALE
CRCW1206000	RES, 0.0Ω, 0.125W, 0%, CHIP-JUMPER	R ₅ ,R ₆ ,R ₁₇	3	CRCW1206000	DALE
CRCW12061001F	RES, 1.0kΩ, 0.125W, .1%, CHIP-THICK-FILM	R ₁₈	1	CRCW12061001F	DALE
CRCW12061002F	RES, 10.0kΩ, 0.125W, 1%, CHIP-THICK-FILM	R ₁ ,R ₇ ,R ₈ ,R ₁₄	4	CRCW12061002F	DALE
CRCW12062000	RES, 200Ω, 0.125W, 1%, CHIP-THICK-FILM	R ₂ ,R ₃ ,R ₄	3	CRCW12062000F	DALE
CRCW12064991F	RES, 4.99kΩ, 0.125W, 1%, CHIP-THICK-FILM	R ₉ ,R ₁₅ ,R ₁₆	3	CRCW12064991F	DALE
C1206C101K5GAC	CAP, 100pF, 50V, 10%, CHIP-CERAMIC COG	C ₁₂ ,C ₂₀	2	C1206C101K5GAC	KEMET
C1206C103K5RAC	CAP, .01uF, 50V, 10%, CHIP-CERAMIC X7R	C ₁₇	1	C1206C103K5RAC	KEMET
C1206C104K5RAC	CAP, 0.10uF, 50V, 10%, CHIP-CERAMIC X7R	C ₁ ,C ₂ ,C ₃ ,C ₄ ,C ₅ ,C ₆	20	C1206C104K5RAC	KEMET
	*	C ₇ ,C ₈ ,C ₉ ,C ₁₀ ,C ₁₁			
	*	C ₁₅ ,C ₁₈ ,C ₂₁ ,C ₂₃ ,C ₂₄			
	*	C ₂₅ ,C ₂₆ ,C ₂₇ ,C ₂₈			
C1206C221K5GAC	CAP, 220pF, 50V, 10%, CHIP-CERAMIC COG	C ₂₂	1	C1206C221K5GAC	KEMET
ICD2053BSC-1	IC, PROGRAMMABLE CLOCK GENERATOR	U4	1	ICD2053BSC-1	
LM4040AIM3-4.1	IC, PREC. V _{REF} 4.1V, 0.1% SOT-23	VR1	1	LM4040AIM3-4.1	
LM7805CT	3-TERM. 5V/1A POS. FIXED REGULATOR, T	U10	1	LM7805CT	National Semi
MAX232ACSE	IC, DRVR/RCVR, RS-232 +5V	U3	1	MAX232ACSE	
OPA350UA	OPAMP, CMOS, SINGLE-SUPPLY	U7,U8,U9	1	OTS-(8)16-1.27-03	
RUE090	FUSE, 30V, RESETTABLE POLYSWITCH	F1	1	RUE090	
SK14	DIODE, SCHOTTKY, 40PIV,1.0A	CR2	1	SK14	
SML-LX1206-GC-TR	LED, SMT 1206, GREEN	CR1	1	SML-LX1206-GC-TR	
SX52BD/PQ	IC, uPROC, 4k WORD 50MHZ.	U1	1	SX52BD/PQ	
TC551001/CFT-70L	IC, MEMORY 1Mb X 8-BIT SRAM	U2	1	TC551001/CFT-70L	
TNPW12061001B	RES 1k 1/8W .1%	R ₁₀ ,R ₁₁ ,R ₁₂ ,R	4	TNPW12061001B	
TSW-102-07-L-S	CONN, 2 POS .1 CTR .025 SQ. POST	JMP1,JMP2,JMP3,JMP4	10	TSW-102-07-L-S	
	*	JMP5,JMP6,JMP7,JMP8			
	*	JMP9,JMP11			
TSW-103-07-L-S	CONN, 3 POS .1 CTR .025 SQ. POST	JMP10	1	TSW-103-07-L-S	
TSW-104-07-L-S	CONN, 4 POS .1 CTR .025 SQ. POST	J1	1	TSW-104-07-L-S	
TSW-105-07-L-S	CONN, 5 POS .1 CTR .025 SQ. POST	J3	1	TSW-105-07-L-S	
T491D106K035AS	CAP, 10uF, 35V, 10%, TANTALUM CHIP-MOLDED	C ₁₃ ,C ₁₄ ,C ₁₆ ,C _{19p}	4	T491D106K035AS	KEMET
VF161SHHL	IC, HYBRID XTAL OSC ,VERY HI SPEED	X1	1	VF161SHHL	
2SV-02	TERM. BLK, 2 POS LEVER POWER CONNECTOR	J4	1	2SV-02	
227699-1	CONN, JACK, BNC, PCB MNT, VERTICAL, 50Ω	J5,J7	2	227699-1	
745781-4	CONN, DB9, RECPT .318 STYLE WITH STD HDWR	J2	1	745781-4	

Total Parts Used: 80

IMPORTANT NOTICE

Texas Instruments and its subsidiaries (TI) reserve the right to make changes to their products or to discontinue any product or service without notice, and advise customers to obtain the latest version of relevant information to verify, before placing orders, that information being relied on is current and complete. All products are sold subject to the terms and conditions of sale supplied at the time of order acknowledgment, including those pertaining to warranty, patent infringement, and limitation of liability.

TI warrants performance of its products to the specifications applicable at the time of sale in accordance with TI's standard warranty. Testing and other quality control techniques are utilized to the extent TI deems necessary to support this warranty. Specific testing of all parameters of each device is not necessarily performed, except those mandated by government requirements.

Customers are responsible for their applications using TI components.

In order to minimize risks associated with the customer's applications, adequate design and operating safeguards must be provided by the customer to minimize inherent or procedural hazards.

TI assumes no liability for applications assistance or customer product design. TI does not warrant or represent that any license, either express or implied, is granted under any patent right, copyright, mask work right, or other intellectual property right of TI covering or relating to any combination, machine, or process in which such products or services might be or are used. TI's publication of information regarding any third party's products or services does not constitute TI's approval, license, warranty or endorsement thereof.

Reproduction of information in TI data books or data sheets is permissible only if reproduction is without alteration and is accompanied by all associated warranties, conditions, limitations and notices. Representation or reproduction of this information with alteration voids all warranties provided for an associated TI product or service, is an unfair and deceptive business practice, and TI is not responsible nor liable for any such use.

Resale of TI's products or services with statements different from or beyond the parameters stated by TI for that product or service voids all express and any implied warranties for the associated TI product or service, is an unfair and deceptive business practice, and TI is not responsible nor liable for any such use.

Also see: [Standard Terms and Conditions of Sale for Semiconductor Products](http://www.ti.com/sc/docs/stdterms.htm). www.ti.com/sc/docs/stdterms.htm

Mailing Address:

Texas Instruments
Post Office Box 655303
Dallas, Texas 75265