



Is Now Part of



**ON Semiconductor®**

To learn more about ON Semiconductor, please visit our website at  
[www.onsemi.com](http://www.onsemi.com)

ON Semiconductor and the ON Semiconductor logo are trademarks of Semiconductor Components Industries, LLC dba ON Semiconductor or its subsidiaries in the United States and/or other countries. ON Semiconductor owns the rights to a number of patents, trademarks, copyrights, trade secrets, and other intellectual property. A listing of ON Semiconductor's product/patent coverage may be accessed at [www.onsemi.com/site/pdf/Patent-Marking.pdf](http://www.onsemi.com/site/pdf/Patent-Marking.pdf). ON Semiconductor reserves the right to make changes without further notice to any products herein. ON Semiconductor makes no warranty, representation or guarantee regarding the suitability of its products for any particular purpose, nor does ON Semiconductor assume any liability arising out of the application or use of any product or circuit, and specifically disclaims any and all liability, including without limitation special, consequential or incidental damages. Buyer is responsible for its products and applications using ON Semiconductor products, including compliance with all laws, regulations and safety requirements or standards, regardless of any support or applications information provided by ON Semiconductor. "Typical" parameters which may be provided in ON Semiconductor data sheets and/or specifications can and do vary in different applications and actual performance may vary over time. All operating parameters, including "Typicals" must be validated for each customer application by customer's technical experts. ON Semiconductor does not convey any license under its patent rights nor the rights of others. ON Semiconductor products are not designed, intended, or authorized for use as a critical component in life support systems or any FDA Class 3 medical devices or medical devices with a same or similar classification in a foreign jurisdiction or any devices intended for implantation in the human body. Should Buyer purchase or use ON Semiconductor products for any such unintended or unauthorized application, Buyer shall indemnify and hold ON Semiconductor and its officers, employees, subsidiaries, affiliates, and distributors harmless against all claims, costs, damages, and expenses, and reasonable attorney fees arising out of, directly or indirectly, any claim of personal injury or death associated with such unintended or unauthorized use, even if such claim alleges that ON Semiconductor was negligent regarding the design or manufacture of the part. ON Semiconductor is an Equal Opportunity/Affirmative Action Employer. This literature is subject to all applicable copyright laws and is not for resale in any manner.



# FGH50N3

## 300 V SMPS IGBT

### General Description

Using Fairchild®'s planar technology, this IGBT is ideal for many high voltage switching applications operating at high frequencies where low conduction losses are essential. This device has been optimized for medium frequency switch mode power supplies.

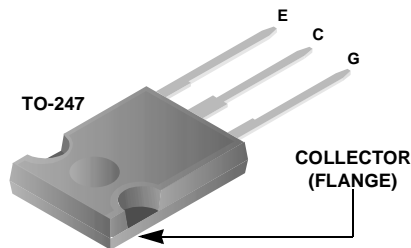
### Features

- Low Saturation Voltage:  $V_{CE(sat)} = 1.4 \text{ V max}$
- Low  $E_{OFF} = 6.6 \text{ uJ/A}$
- $SCWT = 8 \text{ us @ } 125^\circ\text{C}$
- 300V Switching SOA Capability
- Positive Temperature Coefficient above 50 A

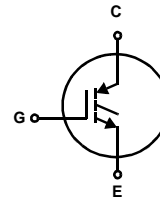
### Applications

- SMPS

### Package



### Symbol



### Device Maximum Ratings $T_C = 25^\circ\text{C}$ unless otherwise noted

Symbol	Parameter	Ratings	Unit
$BV_{CES}$	Collector to Emitter Breakdown Voltage	300	V
$I_{C25}$	Collector Current Continuous, $T_C = 25^\circ\text{C}$	75	A
$I_{C110}$	Collector Current Continuous, $T_C = 110^\circ\text{C}$	75	A
$I_{CM}$	Collector Current Pulsed (Note 1)	240	A
$V_{GES}$	Gate to Emitter Voltage Continuous	$\pm 20$	V
$V_{GEM}$	Gate to Emitter Voltage Pulsed	$\pm 30$	V
SSOA	Switching Safe Operating Area at $T_J = 150^\circ\text{C}$ , Figure 2	150A at 300V	
$E_{AS}$	Single Pulse Avalanche Energy, $I_{CE} = 30\text{A}$ , $L = 1.78\text{mH}$ , $V_{DD} = 50\text{V}$	800	mJ
$E_{ARV}$	Single Pulse Reverse Avalanche Energy, $I_{EC} = 30\text{A}$ , $L = 1.78\text{mH}$ , $V_{DD} = 50\text{V}$	800	mJ
$P_D$	Power Dissipation Total $T_C = 25^\circ\text{C}$	463	W
	Power Dissipation Derating $T_C > 25^\circ\text{C}$	3.7	W/ $^\circ\text{C}$
$T_J$	Operating Junction Temperature Range	-55 to 150	$^\circ\text{C}$
$T_{STG}$	Storage Junction Temperature Range	-55 to 150	$^\circ\text{C}$
$t_{SC}$	Short Circuit Withstand Time (Note 2)	8	$\mu\text{s}$

**CAUTION:** Stresses above those listed in "Device Maximum Ratings" may cause permanent damage to the device. This is a stress only rating and operation of the device at these or any other conditions above those indicated in the operational sections of this specification is not implied.

**NOTE:**

1. Pulse width limited by maximum junction temperature.
2.  $V_{CE(PK)} = 180\text{V}$ ,  $T_J = 125^\circ\text{C}$ ,  $V_{GE} = 12\text{Vdc}$ ,  $R_G = 5\Omega$

## Package Marking and Ordering Information

Device Marking	Device	Package	Tape Width	Quantity
FGH50N3	FGH50N3	TO-247	N/A	30

## Electrical Characteristics $T_J = 25^\circ\text{C}$ unless otherwise noted

Symbol	Parameter	Test Conditions	Min	Typ	Max	Unit
--------	-----------	-----------------	-----	-----	-----	------

### Off State Characteristics

$BV_{CES}$	Collector to Emitter Breakdown Voltage	$I_{CE} = 250\mu\text{A}$ , $V_{GE} = 0\text{V}$	300V	-	-	V	
$BV_{ECS}$	Emitter to Collector Breakdown Voltage	$I_{EC} = 10\text{mA}$ , $V_{GE} = 0\text{V}$	15V	-	-	V	
$I_{CES}$	Collector to Emitter Leakage Current	$V_{CE} = 300\text{V}$	$T_J = 25^\circ\text{C}$	-	-	250	$\mu\text{A}$
			$T_J = 125^\circ\text{C}$	-	-	2.0	mA
$I_{GES}$	Gate to Emitter Leakage Current	$V_{GE} = \pm 20\text{V}$	-	-	$\pm 250$	nA	

### On State Characteristics

$V_{CE(SAT)}$	Collector to Emitter Saturation Voltage	$I_{CE} = 30\text{A}$ $V_{GE} = 15\text{V}$	$T_J = 25^\circ\text{C}$	-	1.30	1.4	V
			$T_J = 125^\circ\text{C}$	-	1.25	1.4	V

### Dynamic Characteristics

$Q_{G(ON)}$	Gate Charge	$I_{CE} = 30\text{A}$ $V_{CE} = 150\text{V}$	$V_{GE} = 15\text{V}$	-	180	-	nC
			$V_{GE} = 20\text{V}$	-	228	-	nC
$V_{GE(TH)}$	Gate to Emitter Threshold Voltage	$I_{CE} = 250\mu\text{A}$ , $V_{CE} = V_{GE}$	4.0	4.8	5.5	V	
$V_{GEP}$	Gate to Emitter Plateau Voltage	$I_{CE} = 30\text{A}$ , $V_{CE} = 150\text{V}$	-	7.0	-	V	

### Switching Characteristics

SSOA	Switching SOA	$T_J = 150^\circ\text{C}$ , $R_G = 5\Omega$ , $V_{GE} = 15\text{V}$ , $L = 25\mu\text{H}$ , $V_{ce} = 300\text{V}$	150	-	-	A	
$t_{d(ON)I}$	Current Turn-On Delay Time	IGBT and Diode at $T_J = 25^\circ\text{C}$ , $I_{CE} = 30\text{A}$ , $V_{CE} = 180\text{V}$ , $V_{GE} = 15\text{V}$ , $R_G = 5\Omega$ , $L = 100\mu\text{H}$ , Test Circuit - Figure 20	-	20	-	ns	
$t_{rI}$	Current Rise Time		-	15	-	ns	
$t_{d(OFF)I}$	Current Turn-Off Delay Time		-	135	-	ns	
$t_{fI}$	Current Fall Time		-	12	-	ns	
$E_{ON2}$	Turn-On Energy (Note 1)		-	130	-	$\mu\text{J}$	
$E_{OFF}$	Turn-Off Energy (Note 2)		-	92	120	$\mu\text{J}$	
$t_{d(ON)I}$	Current Turn-On Delay Time		IGBT and Diode at $T_J = 125^\circ\text{C}$ , $I_{CE} = 30\text{A}$ , $V_{CE} = 180\text{V}$ , $V_{GE} = 15\text{V}$ , $R_G = 5\Omega$ , $L = 100\mu\text{H}$ , Test Circuit - Figure 20	-	19	-	ns
$t_{rI}$	Current Rise Time			-	13	-	ns
$t_{d(OFF)I}$	Current Turn-Off Delay Time			-	155	190	ns
$t_{fI}$	Current Fall Time			-	7	15	ns
$E_{ON2}$	Turn-On Energy (Note 1)	-		225	270	$\mu\text{J}$	
$E_{OFF}$	Turn-Off Energy (Note 2)	-		135	200	$\mu\text{J}$	

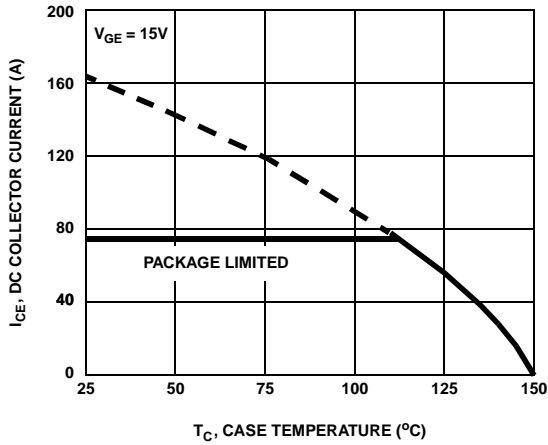
### Thermal Characteristics

$R_{\theta JC}$	Thermal Resistance Junction-Case	TO-247	-	-	0.27	$^\circ\text{C/W}$
-----------------	----------------------------------	--------	---	---	------	--------------------

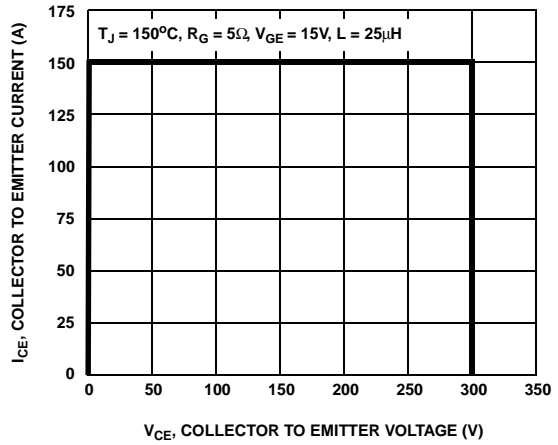
NOTE:

- $E_{ON2}$  is the turn-on loss when a typical diode is used in the test circuit and the diode is at the same  $T_J$  as the IGBT. The diode type is specified in figure 20.
- Turn-Off Energy Loss ( $E_{OFF}$ ) is defined as the integral of the instantaneous power loss starting at the trailing edge of the input pulse and ending at the point where the collector current equals zero ( $I_{CE} = 0\text{A}$ ). All devices were tested per JEDEC Standard No. 24-1 Method for Measurement of Power Device Turn-Off Switching Loss. This test method produces the true total Turn-Off Energy Loss.

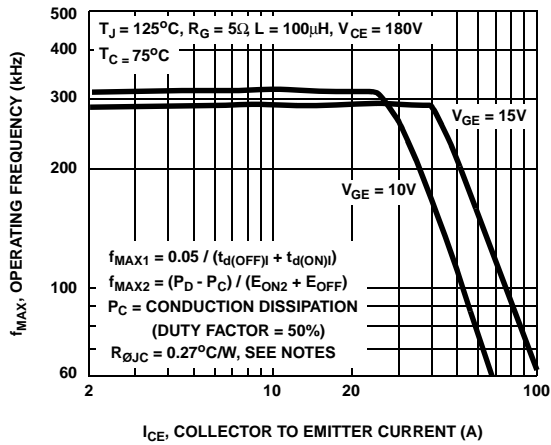
**Typical Performance Curves**  $T_J = 25^\circ\text{C}$  unless otherwise noted



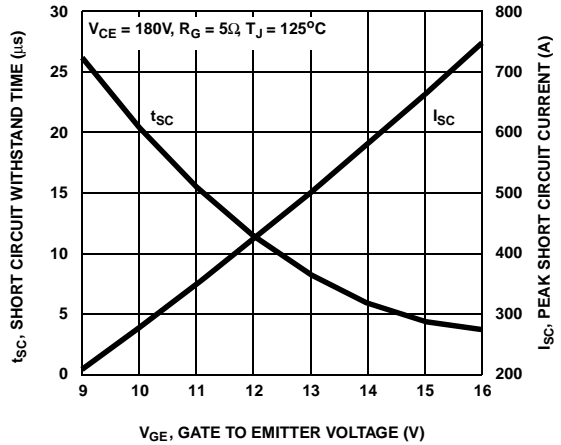
**Figure 1. DC Collector Current vs Case Temperature**



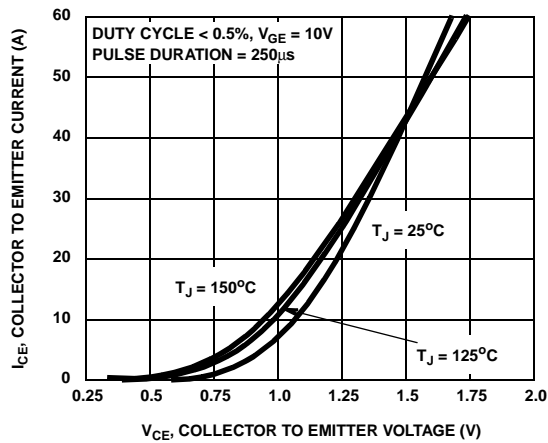
**Figure 2. Minimum Switching Safe Operating Area**



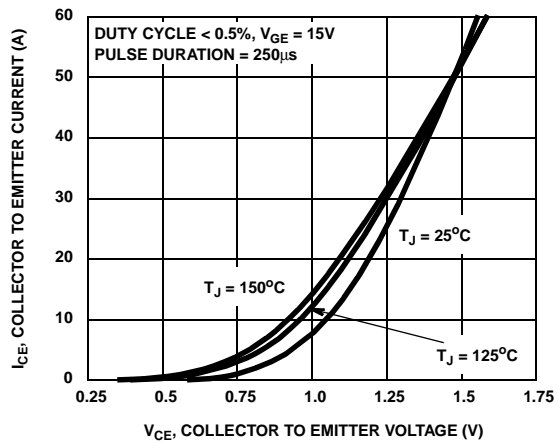
**Figure 3. Operating Frequency vs Collector to Emitter Current**



**Figure 4. Short Circuit Withstand Time**

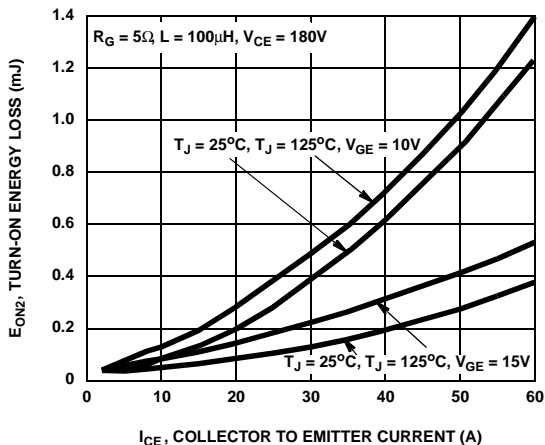


**Figure 5. Collector to Emitter On-State Voltage**

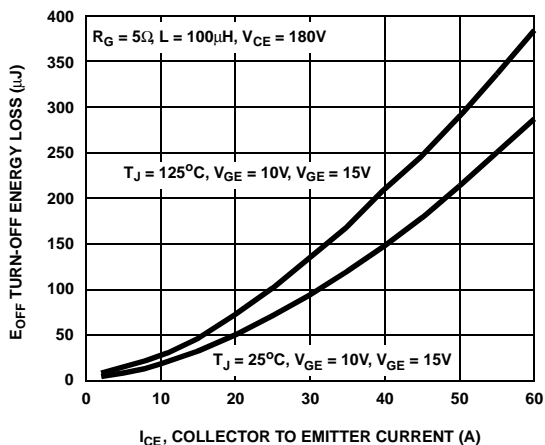


**Figure 6. Collector to Emitter On-State Voltage**

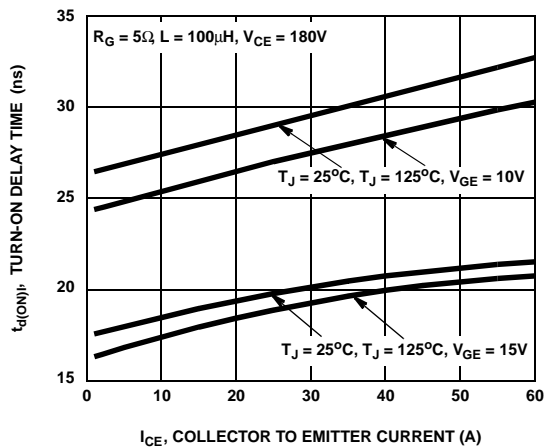
**Typical Performance Curves**  $T_J = 25^\circ\text{C}$  unless otherwise noted (Continued)



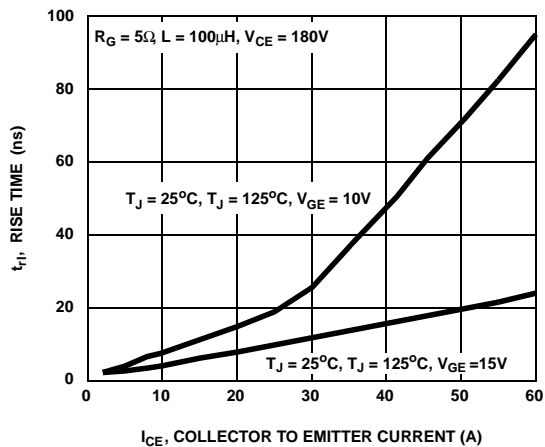
**Figure 7. Turn-On Energy Loss vs Collector to Emitter Current**



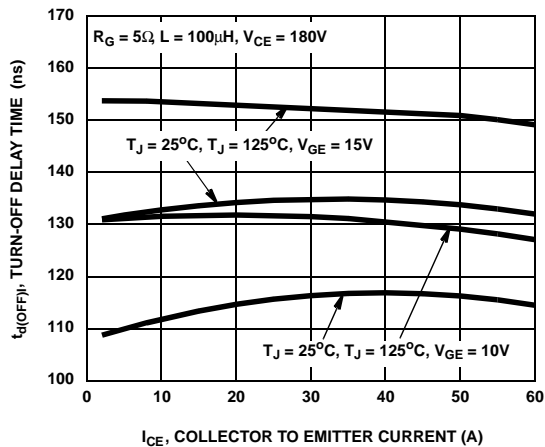
**Figure 8. Turn-Off Energy Loss vs Collector to Emitter Current**



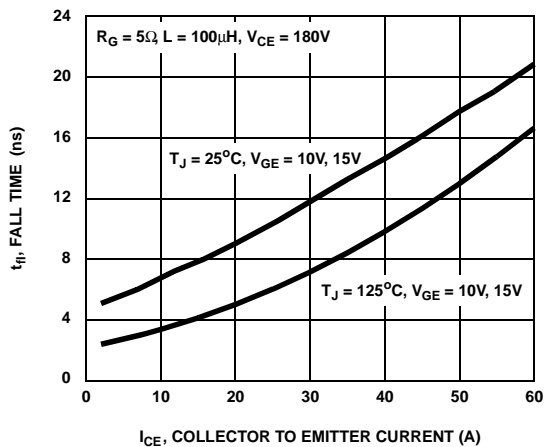
**Figure 9. Turn-On Delay Time vs Collector to Emitter Current**



**Figure 10. Turn-On Rise Time vs Collector to Emitter Current**



**Figure 11. Turn-Off Delay Time vs Collector to Emitter Current**



**Figure 12. Fall Time vs Collector to Emitter Current**

**Typical Performance Curves**  $T_J = 25^\circ\text{C}$  unless otherwise noted (Continued)

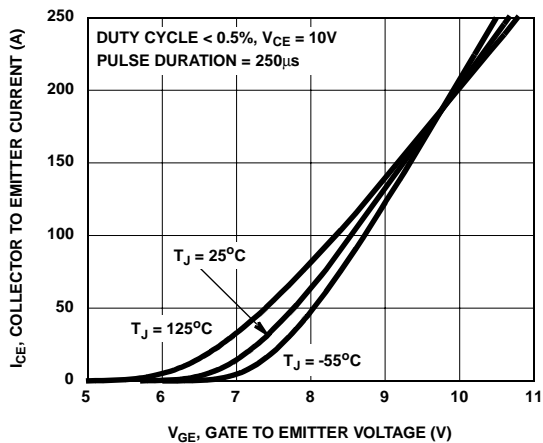


Figure 13. Transfer Characteristic

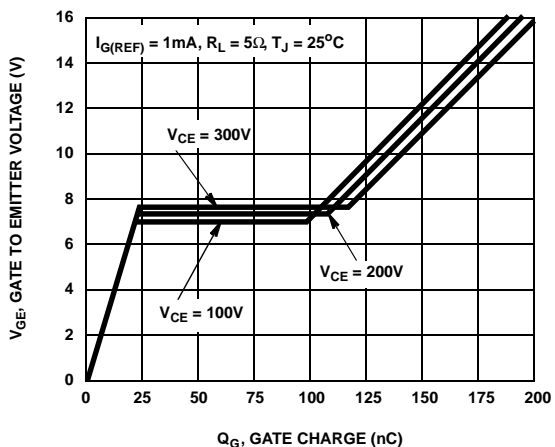


Figure 14. Gate Charge

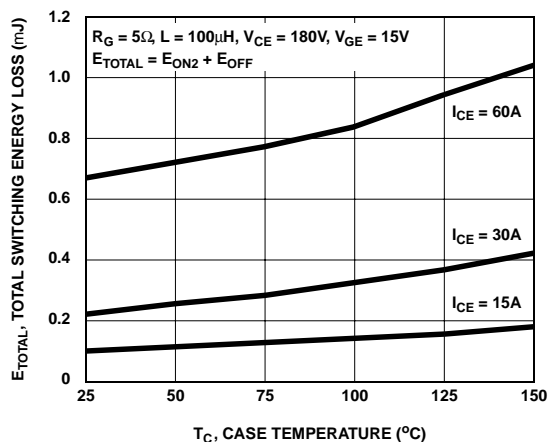


Figure 15. Total Switching Loss vs Case Temperature

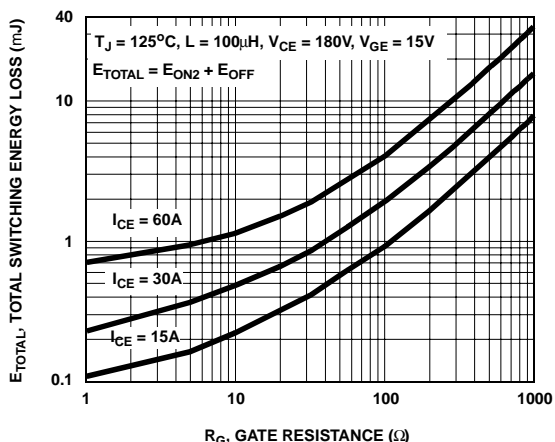


Figure 16. Total Switching Loss vs Gate Resistance

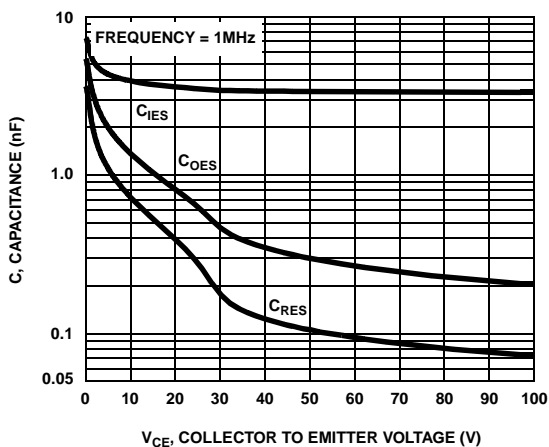


Figure 17. Capacitance vs Collector to Emitter Voltage

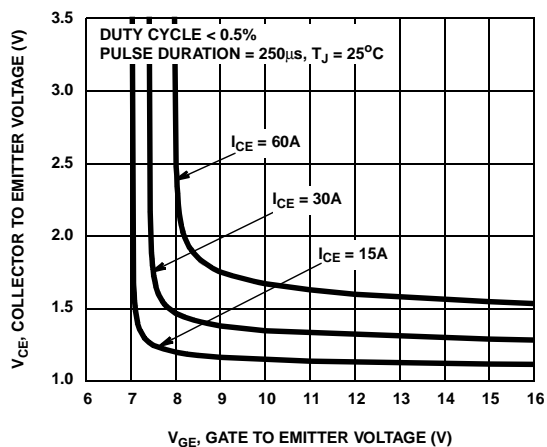


Figure 18. Collector to Emitter On-State Voltage vs Gate to Emitter Voltage

**Typical Performance Curves**  $T_J = 25^\circ\text{C}$  unless otherwise noted (Continued)

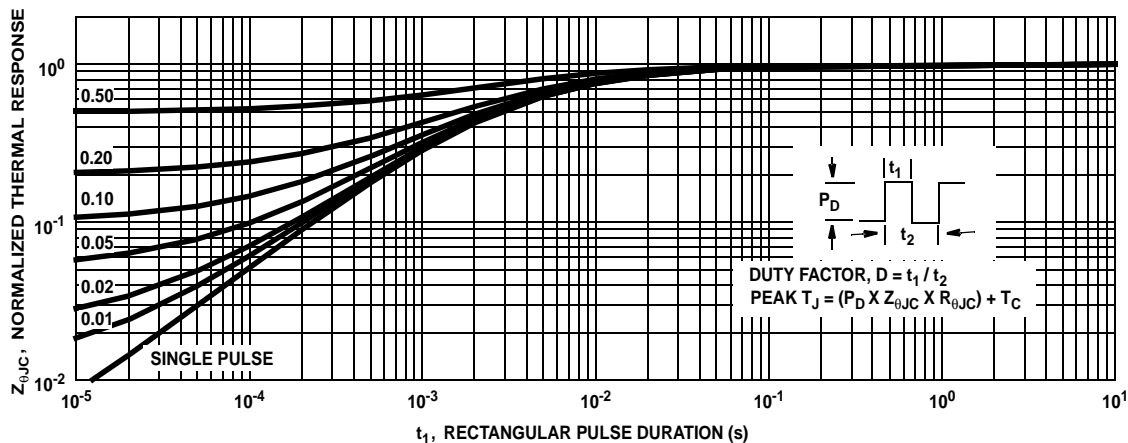


Figure 19. IGBT Normalized Transient Thermal Impedance, Junction to Case

**Test Circuit and Waveforms**

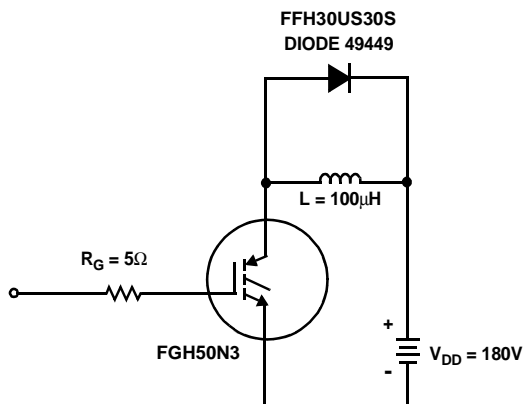


Figure 20. Inductive Switching Test Circuit

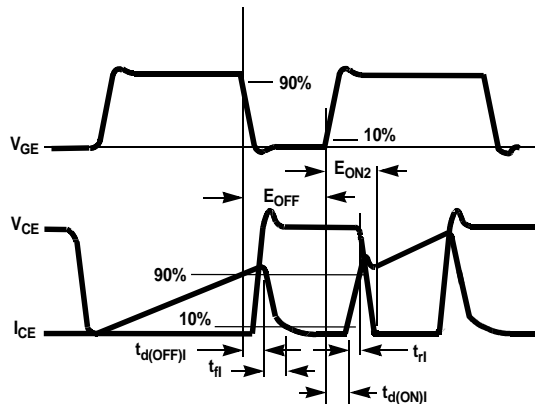
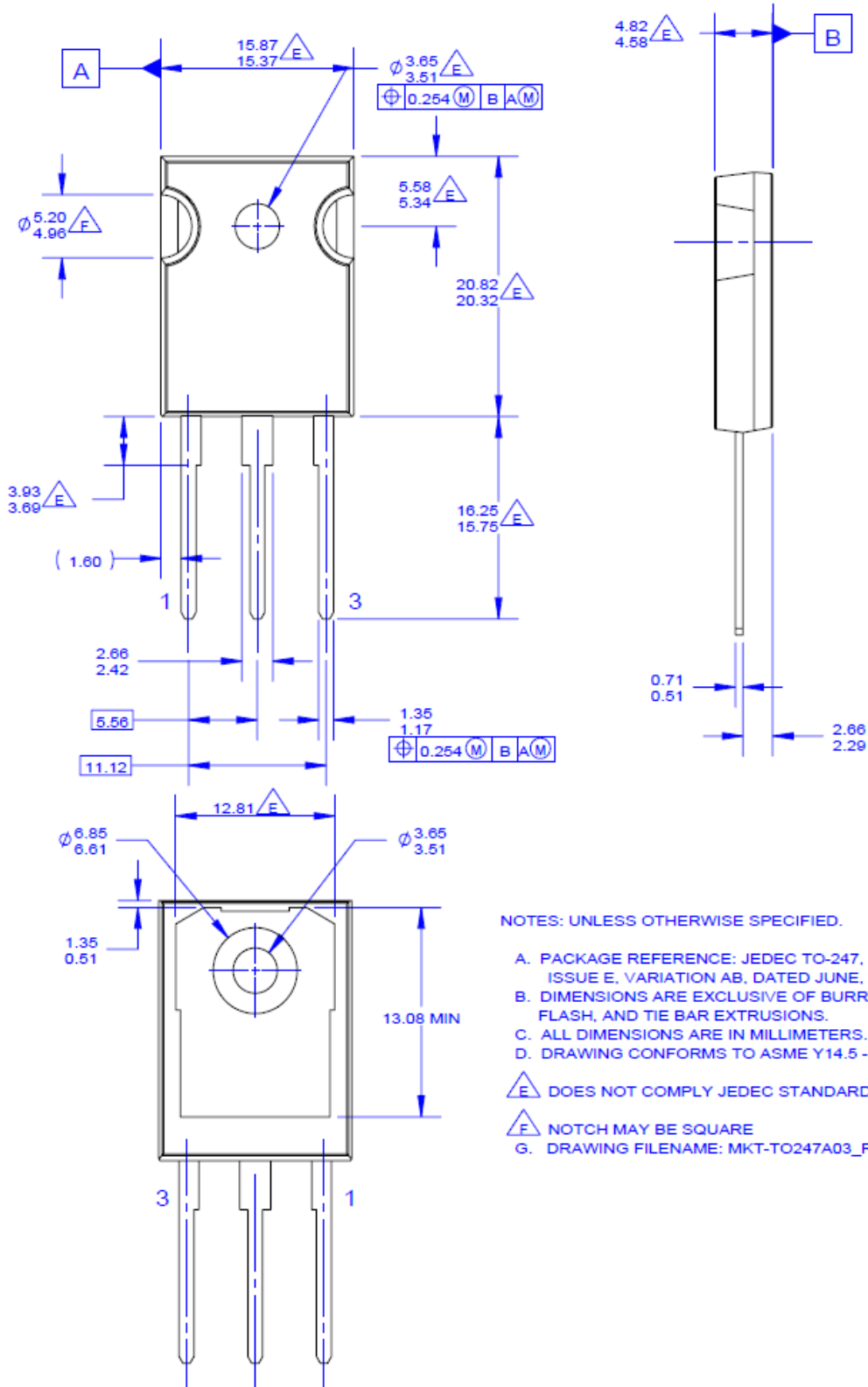


Figure 21. Switching Test Waveforms

Mechanical Dimensions

TO-247A03



NOTES: UNLESS OTHERWISE SPECIFIED.

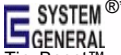



- A. PACKAGE REFERENCE: JEDEC TO-247, ISSUE E, VARIATION AB, DATED JUNE, 2004.
- B. DIMENSIONS ARE EXCLUSIVE OF BURRS, MOLD FLASH, AND TIE BAR EXTRUSIONS.
- C. ALL DIMENSIONS ARE IN MILLIMETERS.
- D. DRAWING CONFORMS TO ASME Y14.5 - 1994
- $\triangle$  DOES NOT COMPLY JEDEC STANDARD VALUE
- $\triangle$  NOTCH MAY BE SQUARE
- G. DRAWING FILENAME: MKT-TO247A03\_REV03





**TRADEMARKS**

The following includes registered and unregistered trademarks and service marks, owned by Fairchild Semiconductor and/or its global subsidiaries, and is not intended to be an exhaustive list of all such trademarks.

- |  |   |  |
|--|---|--|
| 2Cool™   | FPS™  | Sync-Lock™   |
| AccuPower™   | F-PFS™  |  SYSTEM GENERAL™* |
| AX-CAP®*   | FRFET®  | TinyBoost™   |
| BitSiC™  | Global Power Resource <sup>SM</sup>   | TinyBuck™  |
| Build it Now™  | Green Bridge™   | TinyCalc™  |
| CorePLUS™  | Green FPS™  | TinyLogic®   |
| CorePOWER™   | Green FPS™ e-Series™  | TINYOPTO™  |
| CROSSVOLT™   | Gmax™   | TinyPower™   |
| CTL™   | GTO™  | TinyPWM™   |
| Current Transfer Logic™  | IntelliMAX™   | TinyWire™  |
| DEUXPEED®  | ISOPLANAR™  | TranSiC®   |
| Dual Cool™   | Marking Small Speakers Sound Louder and Better™   | TriFault Detect™   |
| EcoSPARK®  | MegaBuck™   | TRUECURRENT®*  |
| EfficientMax™  | MICROCOUPLER™   | µSerDes™   |
| ESBC™  | MicroFET™   |  SerDes™          |
|  Fairchild® | MicroPak™   | UHC®   |
| Fairchild Semiconductor®   | MicroPak2™  | Ultra FRFET™   |
| FACT Quiet Series™   | MillerDrive™  | UniFET™  |
| FACT®  | MotionMax™  | VCX™   |
| FAST®  | mWSaver™  | VisualMax™   |
| FastvCore™   | OptoHiT™  | VoltagePlus™   |
| FETBench™  | OPTOLOGIC®  | XS™  |
|  | OPTOPLANAR®   |  |
|  | PowerTrench®  |  |
|  | PowerXS™  |  |
|  | Programmable Active Droop™  |  |
|  | QFET®   |  |
|  | QS™   |  |
|  | Quiet Series™   |  |
|  | RapidConfigure™   |  |
|  |  Saving our world, 1mW/W/kW at a time™ |  |
|  | SignalWise™   |  |
|  | SmartMax™   |  |
|  | SMART START™  |  |
|  | Solutions for Your Success™   |  |
|  | SPM®  |  |
|  | STEALTH™  |  |
|  | SuperFET®   |  |
|  | SuperSOT™-3   |  |
|  | SuperSOT™-6   |  |
|  | SuperSOT™-8   |  |
|  | SupreMOS®   |  |
|  | SyncFET™  |  |

\*Trademarks of System General Corporation, used under license by Fairchild Semiconductor.

**DISCLAIMER**

FAIRCHILD SEMICONDUCTOR RESERVES THE RIGHT TO MAKE CHANGES WITHOUT FURTHER NOTICE TO ANY PRODUCTS HEREIN TO IMPROVE RELIABILITY, FUNCTION, OR DESIGN. FAIRCHILD DOES NOT ASSUME ANY LIABILITY ARISING OUT OF THE APPLICATION OR USE OF ANY PRODUCT OR CIRCUIT DESCRIBED HEREIN; NEITHER DOES IT CONVEY ANY LICENSE UNDER ITS PATENT RIGHTS, NOR THE RIGHTS OF OTHERS. THESE SPECIFICATIONS DO NOT EXPAND THE TERMS OF FAIRCHILD'S WORLDWIDE TERMS AND CONDITIONS, SPECIFICALLY THE WARRANTY THEREIN, WHICH COVERS THESE PRODUCTS.

**LIFE SUPPORT POLICY**

FAIRCHILD'S PRODUCTS ARE NOT AUTHORIZED FOR USE AS CRITICAL COMPONENTS IN LIFE SUPPORT DEVICES OR SYSTEMS WITHOUT THE EXPRESS WRITTEN APPROVAL OF FAIRCHILD SEMICONDUCTOR CORPORATION.

As used here in:

- Life support devices or systems are devices or systems which, (a) are intended for surgical implant into the body or (b) support or sustain life, and (c) whose failure to perform when properly used in accordance with instructions for use provided in the labeling, can be reasonably expected to result in a significant injury of the user.
- A critical component in any component of a life support, device, or system whose failure to perform can be reasonably expected to cause the failure of the life support device or system, or to affect its safety or effectiveness.

**ANTI-COUNTERFEITING POLICY**

Fairchild Semiconductor Corporation's Anti-Counterfeiting Policy. Fairchild's Anti-Counterfeiting Policy is also stated on our external website, www.fairchildsemi.com, under Sales Support.

Counterfeiting of semiconductor parts is a growing problem in the industry. All manufactures of semiconductor products are experiencing counterfeiting of their parts. Customers who inadvertently purchase counterfeit parts experience many problems such as loss of brand reputation, substandard performance, failed application, and increased cost of production and manufacturing delays. Fairchild is taking strong measures to protect ourselves and our customers from the proliferation of counterfeit parts. Fairchild strongly encourages customers to purchase Fairchild parts either directly from Fairchild or from Authorized Fairchild Distributors who are listed by country on our web page cited above. Products customers buy either from Fairchild directly or from Authorized Fairchild Distributors are genuine parts, have full traceability, meet Fairchild's quality standards for handling and storage and provide access to Fairchild's full range of up-to-date technical and product information. Fairchild and our Authorized Distributors will stand behind all warranties and will appropriately address and warranty issues that may arise. Fairchild will not provide any warranty coverage or other assistance for parts bought from Unauthorized Sources. Fairchild is committed to combat this global problem and encourage our customers to do their part in stopping this practice by buying direct or from authorized distributors.

**PRODUCT STATUS DEFINITIONS**

**Definition of Terms**

Datasheet Identification	Product Status	Definition
Advance Information	Formative / In Design	Datasheet contains the design specifications for product development. Specifications may change in any manner without notice.
Preliminary	First Production	Datasheet contains preliminary data; supplementary data will be published at a later date. Fairchild Semiconductor reserves the right to make changes at any time without notice to improve design.
No Identification Needed	Full Production	Datasheet contains final specifications. Fairchild Semiconductor reserves the right to make changes at any time without notice to improve the design.
Obsolete	Not In Production	Datasheet contains specifications on a product that is discontinued by Fairchild Semiconductor. The datasheet is for reference information only.

Rev. I64

ON Semiconductor and  are trademarks of Semiconductor Components Industries, LLC dba ON Semiconductor or its subsidiaries in the United States and/or other countries. ON Semiconductor owns the rights to a number of patents, trademarks, copyrights, trade secrets, and other intellectual property. A listing of ON Semiconductor's product/patent coverage may be accessed at [www.onsemi.com/site/pdf/Patent-Marking.pdf](http://www.onsemi.com/site/pdf/Patent-Marking.pdf). ON Semiconductor reserves the right to make changes without further notice to any products herein. ON Semiconductor makes no warranty, representation or guarantee regarding the suitability of its products for any particular purpose, nor does ON Semiconductor assume any liability arising out of the application or use of any product or circuit, and specifically disclaims any and all liability, including without limitation special, consequential or incidental damages. Buyer is responsible for its products and applications using ON Semiconductor products, including compliance with all laws, regulations and safety requirements or standards, regardless of any support or applications information provided by ON Semiconductor. "Typical" parameters which may be provided in ON Semiconductor data sheets and/or specifications can and do vary in different applications and actual performance may vary over time. All operating parameters, including "Typicals" must be validated for each customer application by customer's technical experts. ON Semiconductor does not convey any license under its patent rights nor the rights of others. ON Semiconductor products are not designed, intended, or authorized for use as a critical component in life support systems or any FDA Class 3 medical devices or medical devices with a same or similar classification in a foreign jurisdiction or any devices intended for implantation in the human body. Should Buyer purchase or use ON Semiconductor products for any such unintended or unauthorized application, Buyer shall indemnify and hold ON Semiconductor and its officers, employees, subsidiaries, affiliates, and distributors harmless against all claims, costs, damages, and expenses, and reasonable attorney fees arising out of, directly or indirectly, any claim of personal injury or death associated with such unintended or unauthorized use, even if such claim alleges that ON Semiconductor was negligent regarding the design or manufacture of the part. ON Semiconductor is an Equal Opportunity/Affirmative Action Employer. This literature is subject to all applicable copyright laws and is not for resale in any manner.

## PUBLICATION ORDERING INFORMATION

### LITERATURE FULFILLMENT:

Literature Distribution Center for ON Semiconductor  
19521 E. 32nd Pkwy, Aurora, Colorado 80011 USA  
**Phone:** 303-675-2175 or 800-344-3860 Toll Free USA/Canada  
**Fax:** 303-675-2176 or 800-344-3867 Toll Free USA/Canada  
**Email:** [orderlit@onsemi.com](mailto:orderlit@onsemi.com)

**N. American Technical Support:** 800-282-9855 Toll Free  
USA/Canada  
**Europe, Middle East and Africa Technical Support:**  
Phone: 421 33 790 2910  
**Japan Customer Focus Center**  
Phone: 81-3-5817-1050

**ON Semiconductor Website:** [www.onsemi.com](http://www.onsemi.com)  
**Order Literature:** <http://www.onsemi.com/orderlit>  
For additional information, please contact your local  
Sales Representative