

GM5BW96380A Light Emitting Diode

Product Specification Preliminary

Preliminary specifications for
White LED, 2400 mcd @20 mA.

SHARP

SPEC. No. DG-07Z008

ISSUE January 31, 2008

REFERENCE

COMPOUND SEMICONDUCTOR SYSTEMS DIVISION

ELECTRONIC COMPONENTS (ELECOM) GROUP

SHARP CORPORATION

SPECIFICATIONS

DEVICE SPECIFICATION FOR

LIGHT EMITTING DIODE

MODEL No.

GM5BW96380A

CUSTOMERS' APPROVAL

Date _____

By _____

PRESENTED

Date *Jan. 31. 08* _____

By *S. Yokota* _____

S. Yokota
Department General Manager
LED Business Development Center
Compound Semiconductor Systems Division
Electronic Components (ELECOM) Group
SHARP CORPORATION

REFERENCE

No. DG-07Z008

1/14

PRODUCT NAME Chip LED
MODEL No. GM5BW96380A

1. These specification sheets include materials protected under the copyright of Sharp Corporation ("Sharp"). Please do not reproduce or cause anyone to reproduce them without Sharp's consent.
2. When using this product, please observe the absolute maximum ratings and the instructions for use outlined in these specification sheets, as well as the precautions mentioned below. Sharp assumes no responsibility for any damage resulting from use of the product which does not comply with the absolute maximum ratings and the instructions included in these specification sheets, and the precautions mentioned below.

(Precautions)

- (1) This products is designed for use in the following application areas;
[* OA equipment * Audio visual equipment * Home appliance
* Telecommunication equipment (Terminal) * Measuring equipment
* Tooling machines * Computers]
If the use of the product in the above application areas is for equipment listed in paragraphs (2) or (3), please be sure to observe the precautions given in those respective paragraphs.
- (2) Appropriate measures, such as fail-safe design and redundant design considering the safety design of the overall system and equipment, should be taken to ensure reliability and safety when this product is used for equipment which demands high reliability and safety in function and precision, such as ;
[* Transportation control and safety equipment (aircraft, train, automobile etc.)
* Traffic signals * Gas leakage sensor breakers * Rescue and security equipment
* Other safety equipment]
- (3) Please do not use this product for equipment which require extremely high reliability and safety in function and precision, such as ;
[* Space equipment * Telecommunication equipment (for trunk lines)
* Nuclear power control equipment * Medical equipment]
- (4) Please contact and consult with a Sharp sales representative if there are any questions regarding interpretation of the above three paragraphs.

3. Please contact and consult with a Sharp sales representative for any questions about this product.

SHARP

GM5BW96380A Specifications

1. Application

These specifications apply to the light emitting diode device, Model No. GM5BW96380A.

[White color LED composed of an InGaN blue LED chip and yellow phosphor]

This product is designed for various kinds of general indication devices intended for indoor use.

2. Ratings and characteristics ----- Refer to Page 3 to 6.

- 2-1. Absolute maximum ratings
- 2-2. Electro-optical characteristics
- 2-3. Chromaticity rank table
- 2-4. Derating curve
- 2-5. Characteristics Diagram (TYP.)

3. External dimensions and equivalent circuit----- Refer to Page 7.

4. Reliability ----- Refer to Page 8.

- 4-1. Test items and test conditions
- 4-2. Failure criteria

5. Quality level ----- Refer to Page 9.

- 5-1. Applied standard
- 5-2. Sampling inspection
- 5-3. Inspection items and defect criteria

6. Supplements ----- Refer to Page 10 to 12.

- 6-1. Taping
- 6-2. Label (on reel)
- 6-3. Packing
- 6-4. Information on environmental impact substances

7. Precautions ----- Refer to Page 13 to 14.

- 7-1. General handling
- 7-2. Soldering
- 7-3. Cleaning

REFERENCE



2. Ratings and characteristics

2-1. Absolute maximum ratings

(Tc=25 °C)

Parameter	Symbol	Rating	Unit
Power dissipation	P	114	maw
Forward current	I _F	30	mA
Peak pulsed forward current (Note1)	I _{FM}	100	mA
Forward current derating factor	DC	0.6	mA/°C
	Pulse	2.0	mA/°C
Reverse voltage	V _R	5	V
Operating temperature	T _c (Note2)	-30 to +100	°C
Storage temperature	T _{stg}	-40 to +100	°C
Soldering temperature (Note3)	T _{sol}	295	°C

(Note 1) Duty ratio=1/10, Pulse width=0.1 ms.

(Note 2) Tc (As for the measuring point, refer to Page7.)

(Note 3) Each terminal must be soldered with the soldering iron (under 30W) within 3 seconds.
Refer to Page 14, for reflow temperature profile.

(Note 4) The operating current value here follows the derating curve shown in Page5.

(Note 5) Since this LED package is designed so that heat would be radiated from the lead,
the range of operating temperature is defined by case temperature (Tc).

2-2. Electro-optical characteristics

(Tc=25 °C)

Parameter	Symbol	Condition	MIN.	TYP.	MAX.	Unit
Forward voltage	V _F	I _F =20 mA	-	3.2	3.8	V
Luminous intensity (Note6)	I _v		1 800	(2 450)	3 100	mcd
Chromaticity coordinates (Note7)	x		See 2-3.	(0.34)	See 2-3.	
	y	See 2-3.	(0.36)	See 2-3.		
Reverse Current	I _R	V _R =4V	-	-	10	μA

(Note6) Measured by EG&G MODEL550 (Radiometer/ Photometer system) after 20ms drive
(Tolerance : ±15%)

(Note7) Measured by Otsuka electronics MODEL MCPD-2000 after 20ms drive
(Tolerance : x,y:±0.02)

Refer to Page4, for chromaticity rank table.

(Note8) Values inside parenthesis are reference data, and not guaranteed data.

SHARP

REFERENCE

2-3. Chromaticity rank table

(Tc=25 °C)

Rank	Chromaticity coordinates (x, y)								Conditions
	Point 1		Point 2		Point 3		Point 4		
	x	y	x	y	x	y	x	y	
a	0.356	0.375	0.351	0.378	0.347	0.370	0.352	0.368	I _F = 20mA
b	0.352	0.368	0.347	0.370	0.343	0.363	0.348	0.361	
c	0.348	0.361	0.343	0.363	0.339	0.356	0.344	0.354	
d	0.344	0.354	0.339	0.356	0.335	0.349	0.340	0.346	
e	0.340	0.346	0.335	0.349	0.331	0.342	0.336	0.339	
f	0.351	0.378	0.347	0.380	0.342	0.373	0.347	0.370	
g	0.347	0.370	0.342	0.373	0.338	0.366	0.343	0.363	
h	0.343	0.363	0.338	0.366	0.334	0.359	0.339	0.356	
j	0.339	0.356	0.334	0.359	0.330	0.352	0.335	0.349	
k	0.335	0.349	0.330	0.352	0.326	0.345	0.331	0.342	

(Tolerance : ±0.02)

(Note1) Chromaticity ranks are classified under the conditions mentioned in 2-2.

(Note2) Quantity of each rank is decided by Sharp.

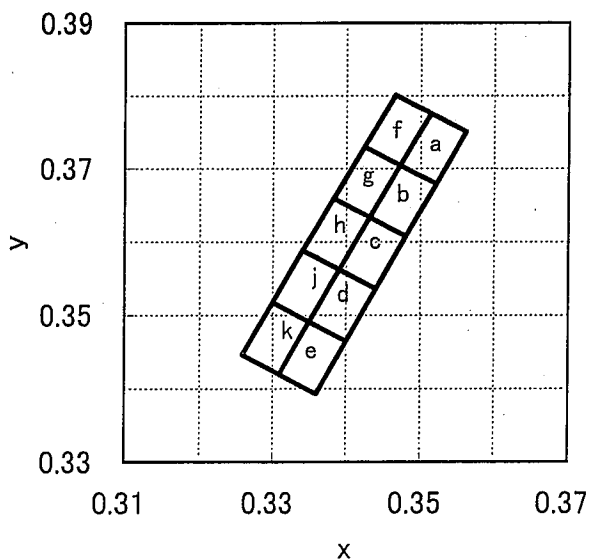

Chromaticity diagram

REFERENCE

SHARP

2-4. Derating curve

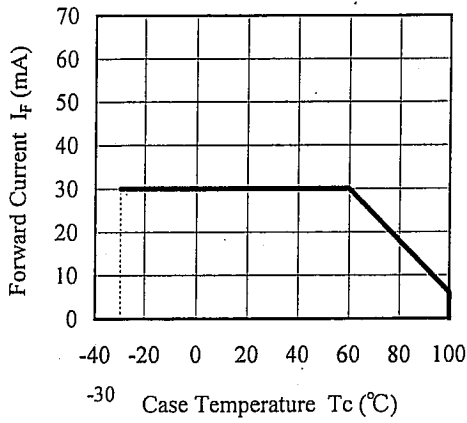

Forward Current Derating Curve

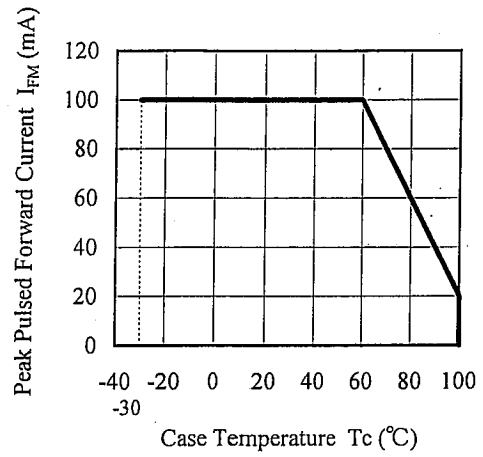

Peak Pulsed Forward Current Derating Curve

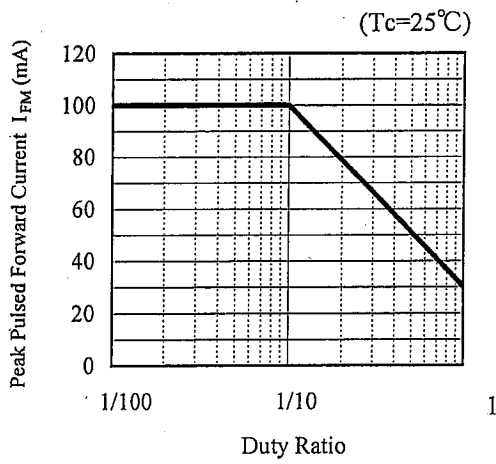

Peak Pulsed Forward Current vs. Duty Ratio



2-5. Characteristics Diagram (TYP.)

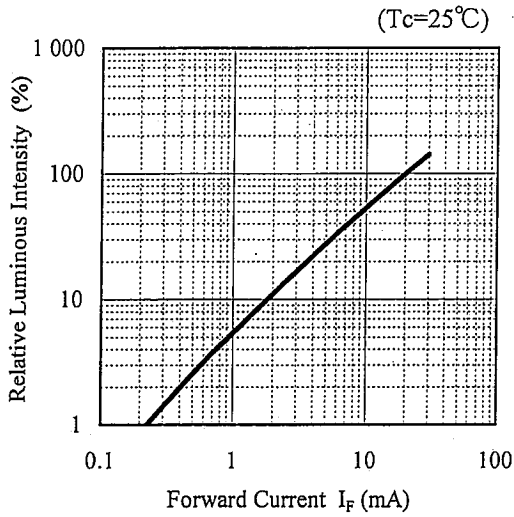

Relative Luminous Intensity vs. Forward Current

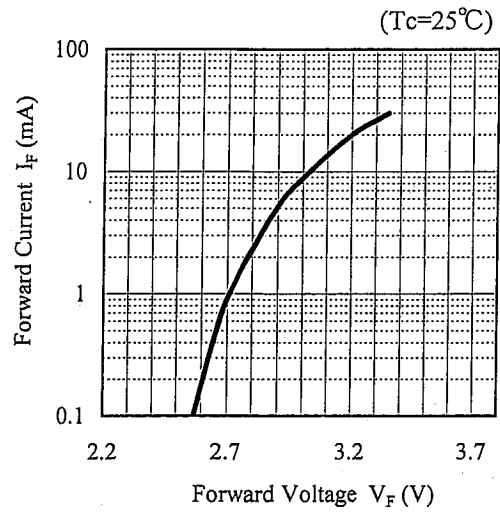

Forward Current vs. Forward Voltage

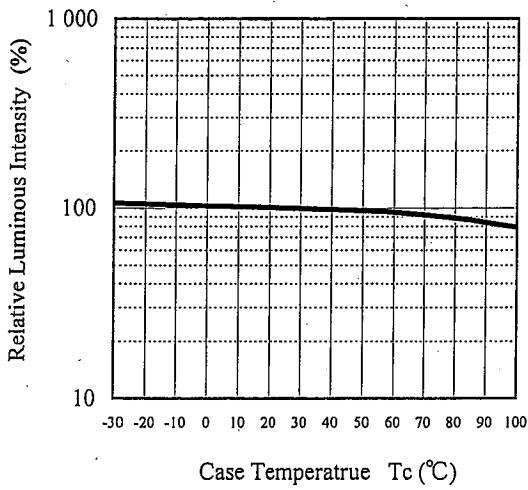

Relative Luminous Intensity vs. Case Temperature

(Note) Data shown here is for reference purpose only. (Not guaranteed values)

REFERENCE

SHARP

3. External dimensions and equivalent circuit

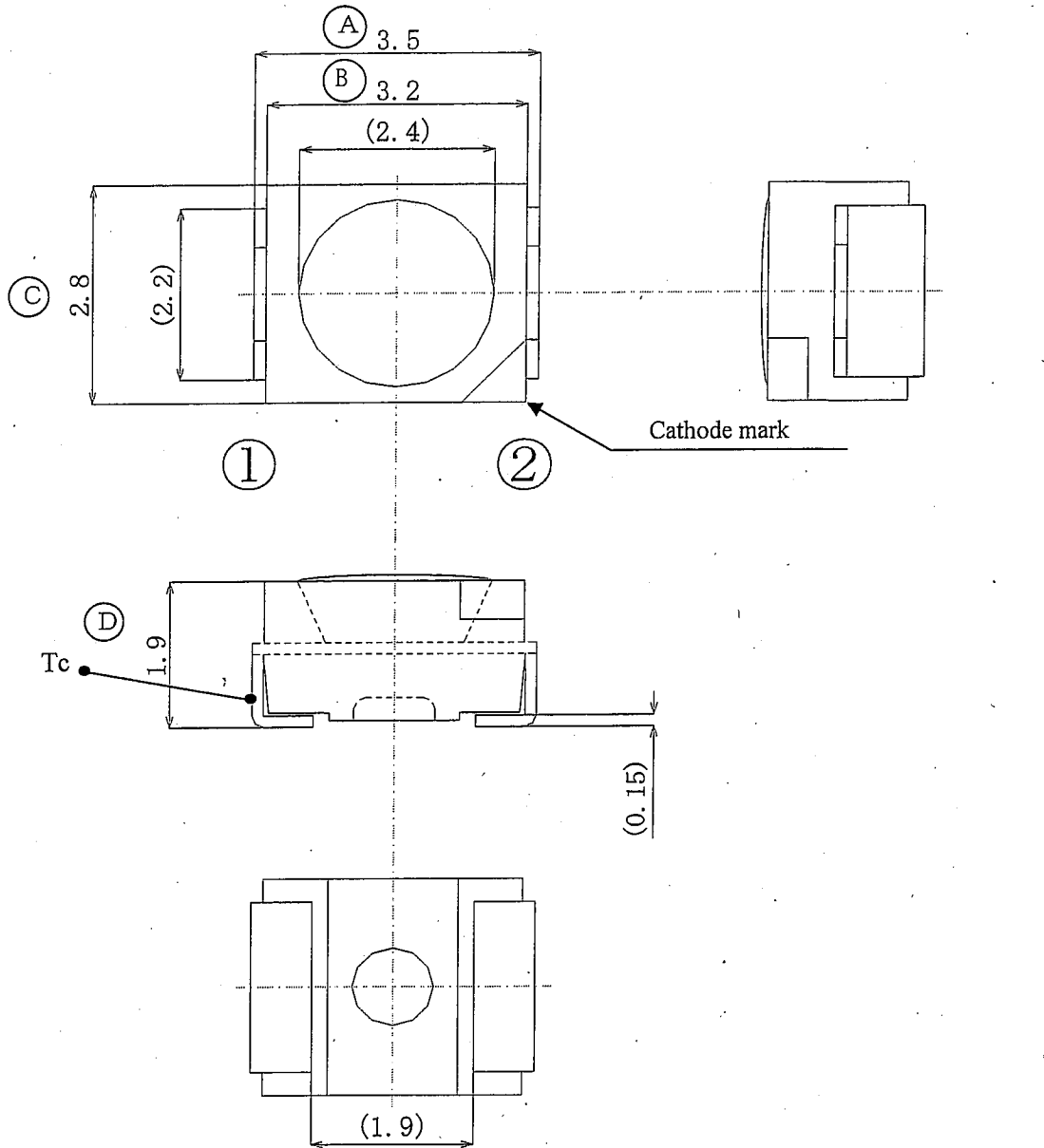

(Notes)

1. Unspecified tolerance to be $\pm 0.3\text{mm}$
2. Values inside parentheses are reference values.
3. Tc: Measuring point of case temperature

Equivalent circuit

Pin arrangement

No.	Name
①	Anode
②	Cathode

Unit	Material	Finish	Drawing No.
mm	Lead: Copper alloy Package: Nylon and Silicone resin	Lead: Ag plating	52001033

SHARP

REFERENCE

4. Reliability

The reliability of products shall be satisfied with items listed below.

4-1. Test items and test conditions

Confidence level: 90%

No.	Test items	Test conditions	Samples n	Defective C	LTPD (%)
1	Temperature cycle	-40 °C (30 min) to +100 °C (30 min), 100 cycles	22	0	10
2	Temperature humidity storage	Tstg = +60 °C, RH = 90 %, time = 1 000 h	22	0	10
3	High temperature storage	Tstg = 100 °C, time = 1 000 h	22	0	10.
4	Low temperature storage	Tstg = -40°C, time = 1 000 h	22	0	10
5	Steady state operating life	Tc = +25 °C, I _F = 30 mA, time = 1 000 h	22	0	10
6	Shock	Acceleration: 15 000 m/s ² , Pulse width: 0.5 ms, Tc = +25°C Direction: 3 directions (X, Y and Z) 3 trials in each direction	11	0	20
7	Vibration	Frequency: 100 to 2 000 Hz for 4 minutes per trial Acceleration: 200 m/s ² Direction: 3 directions (X, Y and Z) 4 trials in each direction, Tc = +25°C	11	0	20
8	Resistance to Soldering heat	Refer to Page14, as for soldering conditions. Twice	11	0	20
9	Solderability	Solder/ Flux: M705/ ESR250 (SENJU METAL INDUSTRY CO., LTD) Solder temperature: 245±5 °C Dip time: 3s, 1 hour after temperature humidity storage at 150°C.	11	0	20

4-2. Failure criteria

No.	Parameter	Symbol	Failure criteria
1	Forward voltage	V _F	V _F > U.S.L × 1.2
2	Reverse current	I _R	I _R > U.S.L × 2.0
3	Luminous intensity	I _V	I _v < Initial value × 0.5, I _v > Initial value × 2.0

(Note1) Measuring conditions accord with the specification.

(Note2) U.S.L. stands for Upper Specification Limit.

(Note3) Solderability failure criterion: NG if less than 90% of the solderability judgment area is not soldered.

Solderability judgment area: bottom and sides of the product (plating area ①, ② and ③ in the figure)

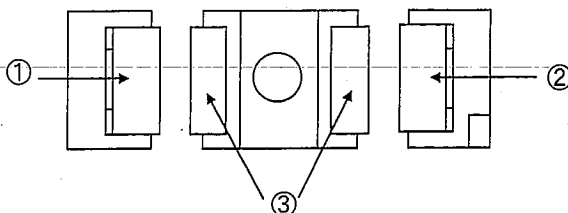

REFERENCE



5. Quality level

5-1. Applied standard
ISO2859-1

5-2. Sampling inspection
A single normal sampling plan, level S-4.

5-3. Inspection items and defect criteria

No.	Inspection items	Defect criteria	Defect	AQL
1	No radiation	No light emitting	Major defect	0.1 %
2	Radiation color	Different from the specified color		
3	Taping	Not conforming to the orientation shown in the specifications		
4	Electro-optical characteristics	Not conforming to specified value in Page3, for V _F , I _R and I _v .	Minor defect	0.4%
5	External dimensions	Not conforming to specified dimensions mentioned in Page7. (From A to D)		
6	Appearance	0.4mm or more in diameter of bubbles, foreign materials, and scratches Resin burr over dimension tolerance 0.4mm or more of resin or terminal chipping		

SHARP

REFERENCE

6. Supplement

6-1. Taping

6-1-1. Shape and dimension of tape (Ref.)

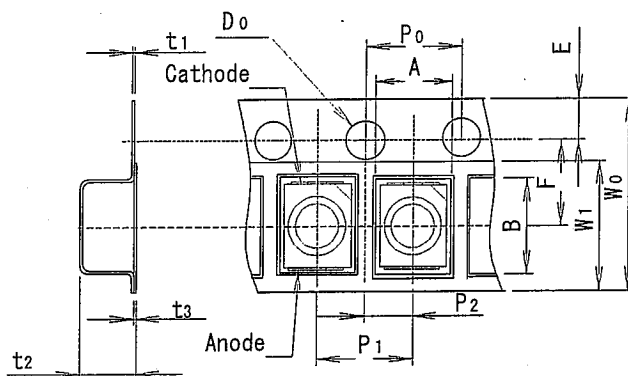

Parameters		Symbols	Dimensions [mm](TYP.)	Remarks
Concave square hole for part insertion	Vertical	A	3.0	Dimension excludes corner R at inside bottom
	Horizontal	B	3.7	
	Pitch	P ₁	4.0	
Round sprocket hole	Diameter	D ₀	1.5	Accumulated error ±0.5mm/10pitch Distance between tape edge and hole center
	Pitch	P ₀	4.0	
	Position	E	1.75	
Center to center dimension	Vert.dir	P ₂	2.0	Center line of the concave square hole and round sprocket hole
	Hori.dir	F	3.5	
Cover tape	Width	W ₁	5.4	
	Thickness	t ₃	0.1	
Carrier tape	Width	W ₀	8.0	
	Thickness	t ₁	0.3	
Thickness of the entire unit		t ₂	2.6	With cover tape and carrier tape combined

6-1-2. Shape and dimension of reel (Ref.)

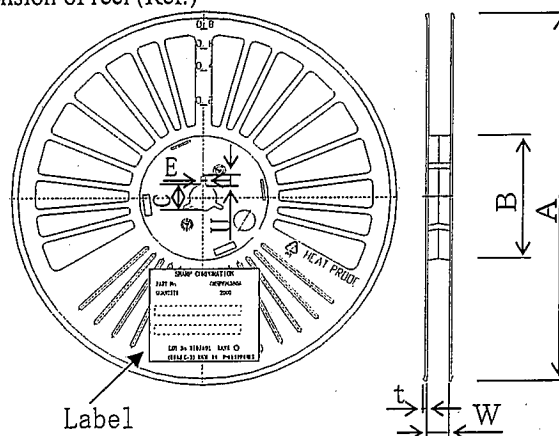

Parameter		Symbol	Dimension [mm]	Remarks	
Flange	Diameter	A	180	Dimension of shaft core	
	Thickness	t	1.3		
	Inner space direction	W	9.5		
Hub	External diameter	B	60		
	Spindle hole diameter	C	13		
	Key slit	Width	E		2.0
		Depth	U		4
Notation for model No. etc.		Labeling on the side of the flange. (Model No., quantity, lot No.)			

Material: on reel

SHARP

REFERENCE

6-1-3. Taping specification

(1) Leader tape: JIS C0806 standard compliant

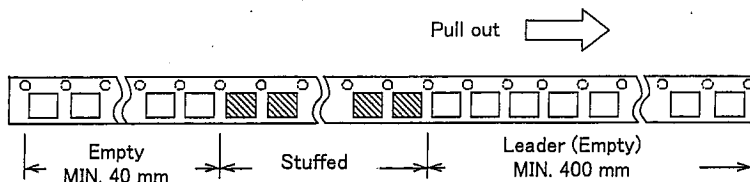

(2) Cover tape strength against peeling: $F = 0.1 \sim 1.0N$ ($\theta = 10^\circ$ or less)

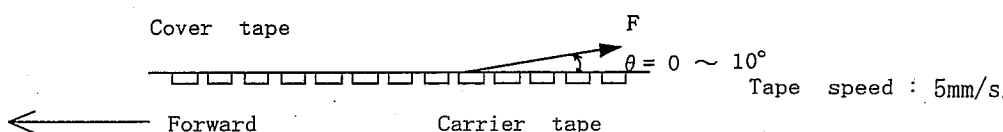

(3) Tape strength against bending:

The radius of bending curvature should be more than 30mm.

If it is bent at under 30mm, the cover may peel off.

(4) Jointing of tape: There should not be joint of cover tape or carrier tape.

(5) Quantity: Average 2 000 pcs. per reel

(6) Product mass: 30 mg (One product/ typ.)

- (7) Others:
- ① There is no continuous empty pockets.
 - ② The quantity of the products lacking should be less than 0.1% of total product quantity.
 - ③ Products should be easily taken out.
 - ④ Products should not be attached to the cover tape when it peeled off.

6-2. Label

<Example>

SHARP CORPORATION		
PART No.	GM5BW96380A	← Model number
QUANTITY	2 000	← Product quantity
[EIAJ C-3 Bar code]		← EIAJ C-3 Bar code
[EIAJ C-3 Bar code]		← EIAJ C-3 Bar code
LOT No. MI07A01 RANK O		← LOT number and rank
(EIAJ C-3) MADE IN PHILIPPINES		← Production country

<LOT Number>

M I 0 7 A 0 1
 ① ② ③ ④

- ① Production plant code (to be indicated alphabetically)
- ② Year of production (the last two figures of the year)
- ③ Month of production
(to be indicated alphabetically with January corresponding to A)
- ④ Date of production (01 ~ 31)

<Rank>

Rank O : Chromaticity rank

SHARP

6-3. Packing

6-3-1. Moisture proof packing

In order to avoid the absorption of humidity while transport and storage, the devices are packed in moisture proof aluminum bags.

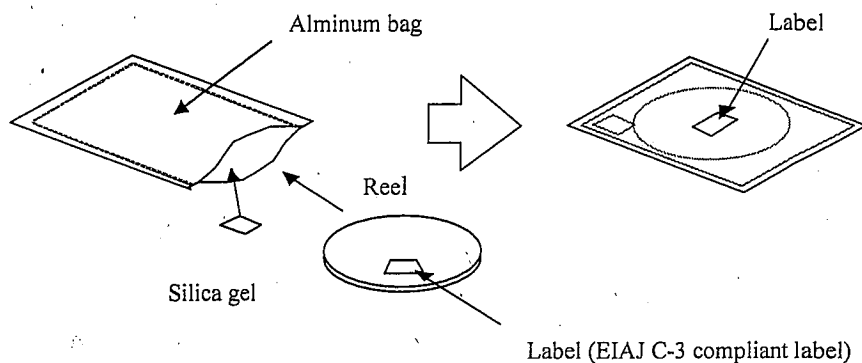

6-3-2. Storage conditions

Temperature: 5 to 30°C, Relative Humidity: 85% or less

6-3-3. Precautions after opening aluminum bags

- (1) Please keep the devices under the following conditions after opened, and give the soldering process within 3 days.

Temperature : 5°C to 30°C Relative humidity: 60% or less

- (2) In case that the devices are not used for a long time after opened, the storage in a dry box would be recommended.

It is also recommended to repack the devices with a desiccative by the sealer and keep them under the same storage conditions as 6-3-2.

- (3) Please give the following baking treatment before soldering to the product once opened and stored.

Recommended conditions:

① In taping : 95°C to 100°C, 16 to 24 hours

② In individual (on PCB or metallic tray):

Temperature: 110 °C to 120 °C , Time: 8 to 12 hours

Deformation of the reels might be caused if the baking process was given under the stressed condition like piling up the products.

Please confirm that the product is cooled to the room temperature after the baking treatment.

6-4. Information on environmental impact substances

6-4-1. RoHS compliant product

This product is manufactured in accordance with RoHS directive.

(Applied to the products manufactured in and after April of 2001.)

6-4-2. Ozone Depleting Substances

- (1) This product doesn't contain the following Ozone Depleting Substances.

- (2) This product doesn't have a production line whose process requires the following Ozone Depleting Substances.

Restricted substances: CFCs, Halones, CCl₄, 1, 1, 1-Trichloroethane (Methyl chloroform)

SHARP

7. Precautions

7-1. General handling

- ① Avoid applying any reverse voltage to the product when designing circuit.
- ② Since the products are very small, they are easily damaged by external stress.
Please avoid applying stress to them during and after the assemblies.
- ③ Color tone is subject to variation due to the afterglow of the phosphor in pulse drive.
- ④ Do not look directly at LEDs with unshielded eyes, or damage to your eyes may result.
- ⑤ Static electricity or surge voltage can deteriorate product and its reliability.
Please equip yourself with a wrist band or anti-electricity gloves in handling the products.
Also, make sure that all the devices and equipments must be grounded.
- ⑥ Materials with high thermal conductivity is used in this product in order to allow generated heat to escape effectively out of the LED. Avoid locating other heat sources (ex. resistance, etc.) near the products on the circuit board to protect the devices from the heat damage.
Please make sure that case temperature is always under 100 °C during operation, including the self-heating.
- ⑦ Since dust on the surface of the radiation part is hard to remove and may decrease the luminous intensity, please handle the products in a clean, non-dusty condition.
Also, excessive stress to the resin by collets of mounting equipment can damage the devices.
Please verify your mounting conditions prior to use.
- ⑧ Please make sure not to apply any external stress to resin after mounted as well.
- ⑨ The products are not designed for the use under any of the following conditions. Please verify their performance and reliability well enough if you use under any of the following conditions;
 - (1) In a place with a lot of moisture, dew condensation, briny air, and corrosive gas (Cl, H₂S, NH₃, SO₂, NO_x, etc.).
 - (2) Under the direct sunlight, outdoor exposure, and in a dusty place.
 - (3) In water, oil, medical fluid, and organic solvent.

7-2. Soldering

7-2-1. Reflow

- (1) Please solder the products so that case temperature is according to the temperature profile.
Caused by substrate bend or the other mechanical stress during reflow soldering may happen gold wire disconnection etc. Therefore please verify your reflow conditions prior to use.
- (2) In case of giving reflow process twice, the second reflow process should be given as soon as possible after the first one.
- (3) The electrode parts are silver plated on. If they are exposed to the air with corrosive gas etc., the plated surface would be eroded, which may affect soldering.
Please be careful of the storage condition, and avoid long-term storage.

SHARP

REFERENCE

(4) Temperature profile

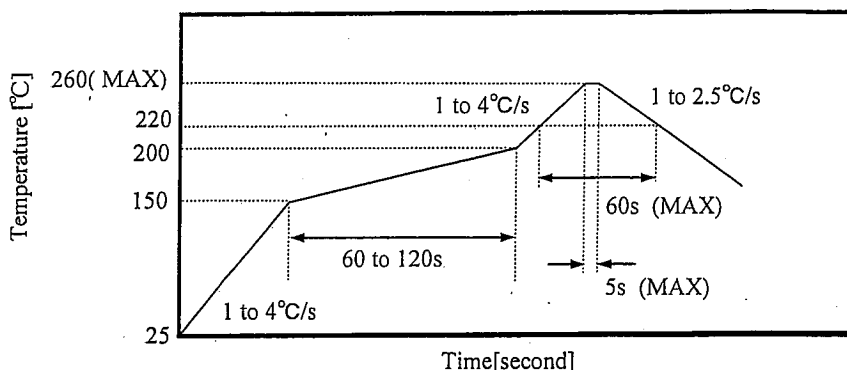

In order to maintain the products quality, it is recommended that the peak temperature should be lower, and cool down should be taken longer, and that the gradient of cool down temperature should be as low as possible. Moreover, since the thermal conduction to the products depends on the specification of the reflow machine, and the size and layout of the PCBs. Please verify your solder conditions carefully.

(5) Recommended solder pad design

Solderability depends on the reflow condition, solder paste and materials of the PCBs etc. Please check and study actual solder ability before usage.

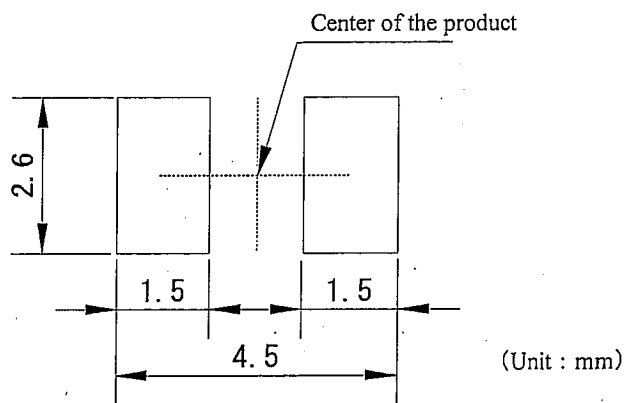

(6) Precaution for PCB backside dip process

Please check and study your conditions carefully in giving the dip process on the backside of the PCBs, since the warped boards caused by heat and heat itself affect the inside of the package. It is recommended to give the reflow process after dip process. Though it is also available to give the reflow process before the dip process, the interval of the two processes should be as short as possible.

7-3. Cleaning

Avoid cleaning the PCBs, since packages and resins would be eroded by cleaning. Please use the soldering paste without need of cleaning. Avoid ultrasonic cleaning.

Opto Specification

Opto/EC Group



NORTH AMERICA

Sharp Microelectronics of the Americas
5700 NW Pacific Rim Blvd.
Camas, WA 98607, U.S.A.
Phone: (1) 360-834-2500
Fax: (1) 360-834-8903
www.sharpsma.com

TAIWAN

Sharp Electronic Components
(Taiwan) Corporation
8F-A, No. 16, Sec. 4, Nanking E. Rd.
Taipei, Taiwan, Republic of China
Phone: (886) 2-2577-7341
Fax: (886) 2-2577-7326/2-2577-7328

CHINA

Sharp Microelectronics of China
(Shanghai) Co., Ltd.
28 Xin Jin Qiao Road King Tower 16F
Pudong Shanghai, 201206 P.R. China
Phone: (86) 21-5854-7710/21-5834-6056
Fax: (86) 21-5854-4340/21-5834-6057
Head Office:
No. 360, Bashen Road,
Xin Development Bldg. 22
Waigaoqiao Free Trade Zone Shanghai
200131 P.R. China
Email: smc@china.global.sharp.co.jp

EUROPE

Sharp Microelectronics Europe
Division of Sharp Electronics (Europe) GmbH
Sonninstrasse 3
20097 Hamburg, Germany
Phone: (49) 40-2376-2286
Fax: (49) 40-2376-2232
www.sharpsme.com

SINGAPORE

Sharp Electronics (Singapore) PTE., Ltd.
438A, Alexandra Road, #05-01/02
Alexandra Technopark,
Singapore 119967
Phone: (65) 271-3566
Fax: (65) 271-3855

KOREA

Sharp Electronic Components
(Korea) Corporation
RM 501 Geosung B/D, 541
Dohwa-dong, Mapo-ku
Seoul 121-701, Korea
Phone: (82) 2-711-5813 ~ 8
Fax: (82) 2-711-5819

JAPAN

Sharp Corporation
Electronic Components & Devices
22-22 Nagaïke-cho, Abeno-Ku
Osaka 545-8522, Japan
Phone: (81) 6-6621-1221
Fax: (81) 6117-725300/6117-725301
www.sharp-world.com

HONG KONG

Sharp-Roxy (Hong Kong) Ltd.
3rd Business Division,
17/F, Admiralty Centre, Tower 1
18 Harcourt Road, Hong Kong
Phone: (852) 28229311
Fax: (852) 28660779
www.sharp.com.hk
Shenzhen Representative Office:
Room 13B1, Tower C,
Electronics Science & Technology Building
Shen Nan Zhong Road
Shenzhen, P.R. China
Phone: (86) 755-3273731
Fax: (86) 755-3273735

SPECIFICATIONS ARE SUBJECT TO CHANGE WITHOUT NOTICE.

Suggested applications (if any) are for standard use; See Important Restrictions for limitations on special applications. See Limited Warranty for SHARP's product warranty.

The Limited Warranty is in lieu, and exclusive of, all other warranties, express or implied.

ALL EXPRESS AND IMPLIED WARRANTIES, INCLUDING THE WARRANTIES OF MERCHANTABILITY, FITNESS FOR USE AND FITNESS FOR A PARTICULAR PURPOSE, ARE SPECIFICALLY EXCLUDED. In no event will SHARP be liable, or responsible in any way, for any incidental or consequential economic or property damage.